

*Automatic Train Control in Rail Rapid
Transit*

May 1976

NTIS order #PB-254738



**Automatic Train Control
in Rail Rapid Transit**



UNITED STATES CONGRESS
Office of Technology Assessment

May 1976

OFFICE OF TECHNOLOGY ASSESSMENT

CONGRESSIONAL BOARD

Representative Olin E. Teague, Texas, Chairman
Senator Clifford P. Case, New Jersey, Vice Chairman

SENATE

Edward M. Kennedy
Massachusetts

Ernest F. Hollings
South Carolina

Hubert H. Humphrey
Minnesota

Richard S. Schweiker
Pennsylvania

Ted Stevens
Alaska

HOUSE

Morris K. Udall
Arizona

George E. Brown, Jr.
California

Charles A. Mosher
Ohio

Marvin L. Esch
Michigan

Marjorie S. Holt
Maryland

Emilio Q. Daddario, ex officio

OFFICE OF TECHNOLOGY ASSESSMENT

DIRECTOR'S OFFICE

Emilio Q. Daddario, Director

Daniel V. De Simone, Deputy Director

URBAN MASS TRANSIT ADVISORY PANEL

George Krambles, Chairman, Chicago Transit Authority

Walter J. Bierwagen Amalgamated Transit Union	Bernard M. Oliver Hewlett-Packard Corporation
Robert A. Burco Oregon DOT	Simon Reich Train Control Consultant
Jeanne J. Fox Joint Center for Political Studies	Thomas C. Sutherland, Jr. Princeton University
Lawrence A. Goldmuntz Economics and Science Planning	Frederick P. Salvucci Massachusetts DOT
Dorn McGrath George Washington University	Stewart F. Taylor Sanders and Thomas, Inc.

OTA TRANSPORTATION PROGRAM STAFF

Gretchen S. Kolsrud, Program Manager

Mary E. Ames	Larry L. Jenney
V. Rodger Digilio	Bev Johnson
Thomas E. Hirsch III	Teri Miles

TECHNICAL CONSULTANTS

Battelle Columbus Laboratories

TECHNOLOGY ASSESSMENT BOARD

OLIN E. TEAGUE, TEXAS, CHAIRMAN
CLIFFORD P. CASE, N.J., VICE CHAIRMAN

EDWARD M. KENNEDY, MASS. MORRIS K. UDALL, ARIZ.
ERNEST F. HOLLINGS, S.C. GEORGE E. BROWN, JR., CALIF.
HUBERT H. HUMPHREY, MINN. CHARLES A. MOSHER, OHIO
RICHARD S. SCHWEIKER, PA. MARVIN L. ESCH, MICH.
TED STEVENS, ALASKA MARJORIE S. HOLT, MD.
EMILIO Q. DADDARIO

Congress of the United States

OFFICE OF TECHNOLOGY ASSESSMENT

WASHINGTON, D.C. 20510

EMILIO Q. DADDARIO
DIRECTOR

DANIEL V. De SIMONE
DEPUTY DIRECTOR

FEB 17 1976

The Honorable John L. McClellan
Chairman, Committee on Appropriations
United States Senate
Washington, D.C. 20510

Dear Mr. Chairman:

We are pleased to transmit the enclosed report on "Automatic Train Control in Rail Rapid Transit".

Prepared by the Office of Technology Assessment with the assistance of its Urban Mass Transit Advisory Panel, this report describes the technology of automatic train control systems and assesses the operational, planning, and policy issues arising from the use of automated devices to control and direct rail rapid transit vehicles. The report also contains background material useful for understanding the application of automation technology in urban rail transit systems.

The findings presented herein are a synthesis of the views of those participating in the study and do not necessarily reflect the opinions of individual members of the Technology Assessment Board of OTA.

Sincerely,

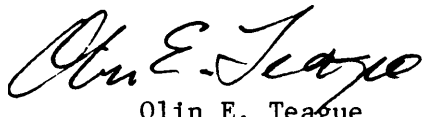

Olin E. Teague
Chairman

Sincerely,



Clifford P. Case
Vice Chairman

Enclosure

TECHNOLOGY ASSESSMENT BOARD

OLIN E. TEAGUE, TEXAS, CHAIRMAN
CLIFFORD P. CASE, N.J., VICE CHAIRMAN

EDWARD M. KENNEDY, MASS. MORRIS K. UDALL, ARIZ.
ERNEST F. HOLLINGS, S.C. GEORGE E. BROWN, JR., CALIF.
HUBERT H. HUMPHREY, MINN. CHARLES A. MOSHER, OHIO
RICHARD S. SCHWEIKER, PA. MARVIN L. ESCH, MICH.
TED STEVENS, ALASKA MARJORIE S. HOLT, MD.
EMILIO Q. DADDARIO

Congress of the United States

OFFICE OF TECHNOLOGY ASSESSMENT

WASHINGTON, D.C. 20510

EMILIO Q. DADDARIO
DIRECTOR

DANIEL V. DeSIMONE
DEPUTY DIRECTOR

FEB 17 1976

The Honorable Olin E. Teague
Chairman
Technology Assessment Board
Congress of the United States
Washington, D.C. 20515

Dear Mr. Chairman:

I am pleased to submit OTA's report on "Automatic Train Control in Rail Rapid Transit," which was requested by Senator John L. McClellan, Chairman of the Senate Appropriations Committee, on behalf of Senator Robert C. Byrd and Senator Clifford P. Case of the Transportation Appropriations Subcommittee.

This report was prepared by the Office of Technology Assessment with the assistance of its Urban Mass Transit Advisory Panel, composed of representatives of the transit industry, engineering firms, planning and development organizations, universities, organized labor, and citizen participation groups.

The material in this report will be used by the requesting committee for hearings related to the Urban Mass Transportation Administration and the Federal Railroad Administration during the coming year. The report will also be available to other Senate and House committees concerned with urban transportation problems.

Sincerely,

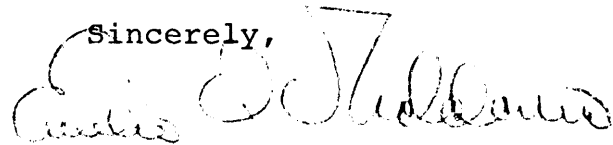

EMILIO Q. DADDARIO
Director

Enclosure

Preface

This report, prepared by OTA at the request of the Senate Committee on Appropriations on behalf of the Transportation Subcommittee, is an assessment of the technology of automatic train control in rail rapid transit systems. Automatic train control (ATC) is the general designation for a variety of techniques by which machines regulate the movement of rail rapid transit vehicles for the purposes of safety and efficiency. Functionally, ATC includes:

- Train Protection
- Train Operation
- Train Supervision
- Communication

The use of the term “automatic” does not imply that train control or any of its constituent functions is carried out wholly without human involvement in operating the equipment or in overseeing automated devices. Rather, automatic is used to denote systems in which machines perform a substantial part of the routine functions and there is minimal reliance on man as an operational element. Man’s role in such systems is to monitor the performance of automatic elements and to act as the ultimate safety backup.

The history of train control technology has seen extensive, but not complete, replacement of the human operator by machines. The number of people required to run trains, operate wayside equipment, and supervise traffic has been reduced by automation to the point where the newest transit systems now have only a single on-board operator for the train, regardless of its length, and a small cadre of centrally located supervisors.

The increasing reliance on automation, both in existing transit systems and those under development, raises several basic issues about this application of technology. The importance of these issues was recognized by the Senate Committee on Appropriations Transportation Subcommittee who requested the Office of Technology Assessment to study automation in federally supported rail rapid transit projects. Correspondence relating to the request is contained in Appendix I of this report; the following is a paraphrase of the fundamental questions posed in the letter of request:

How does reduction of man’s responsibility for direct operational control affect the safety of transit systems?

What operational advantages are to be gained from automation?

Is automation cost-effective, considering both capital and operating costs?

Does the planning, development, and testing of automatic train control systems give adequate attention to the safety, performance, and cost implications of automation?

Are there policy and institutional factors that influence the selection of a level of automation or that condition the application of automatic train control technology?

Because of the number and complexity of the issues to be addressed, the technology assessment was divided into three separate, but coordinated, studies dealing with (1) the planning process, (2) automated small vehicle systems, and (3) automatic train control in rail rapid transit. Reports on the first two topics have been published in separate volumes.¹This report deals with the third topic, specifically the degree of automation which is technically feasible, economically justifiable, or otherwise appropriate for rail rapid transit.

The technology assessment presented here is the product of a combined effort of the OTA Urban Mass Transit Advisory Panel and the staff of the OTA Transportation Program. Major assistance was received from Battelle Columbus Laboratories in collecting data and providing technical background information. These materials and other information collected independently were combined by the panel and staff to prepare this report. The panel and staff are also indebted to the urban transit system officials and representatives of the transit industry who gave access to their records and participated in numerous technical discussions.

Since this report is the result of a joint effort, the findings should not be construed as the view of any individual participant. Divergent opinions are included; and, where the subject matter is controversial, an attempt has been made to present a balanced treatment.

The OTA staff members participating in this study were: Dr. Gretchen S. Kolsrud, Program Manager; Larry L. Jenney, Project Director; V. Rodger Digilio, Thomas E. Hirsch III, Bev Johnson, and Teri Miles.

¹See *An Assessment of Community Planning for Mass Transit*, February 1976 (Report Nos. OTA-T-16 through OTA-T-27) and *Automated Guideway Transit: An Assessment of PRT and Other New Systems* (Report No. OTA-T-8), June 1975.

CONTENTS

	Page
PREFACE	vii
LIST OF TABLES	xi
LIST OF FIGURES	o..xii
CHAPTER 1: FINDINGS	1
Definitions.	2
Introduction	3
Policy and Institutional Factors	3
The Planning, Development, and Testing Process	4
Operational Experience	5
Assessment of ATC Technology	6
CHAPTER 2: BACKGROUND. 00....	9
Rail Rapid Transit.	11
Objectives	12
Scope0.....	012
Study Method..	13
Organization. o. 0	13
CHAPTER 3: AUTOMATIC TRAIN CONTROL	15
Train Control System Functions	17
Automation	20
Automatic Train Control Technology	22
A Walk Through a Transit System	33
Levels of Automation	40
CHAPTER 4: TRANSIT SYSTEM DESCRIPTIONS0.....	43
Bay Area Rapid Transit (BART)	45
Chicago Transit Authority (CTA)	49
Massachusetts Bay Transportation Authority (MBTA)	55
New York City Transit Authority (NYCTA).	60
Port Authority Transit Corporation (PATCO).	65
Systems Under Development	1..69
CHAPTER 5: OPERATIONAL EXPERIENCE0...75	75
Introduction	77
Safety0....	0...77
Issue O-1: Train Protection	78
Issue O-2: Train Operation	81
Issue O-3: Design Safety *	84
Issue O-4: Passenger Security	87
Performance. \$	90
Issue O-5: Ride Quality	90
Issue O-6: Level of Service	93
Issue o-7: Reliability	99
Issue O-8: Maintainability0.....	105

	Page
Cost.	109
Issue O-9: Capital Cost	110
Issue O-10: Operational Cost.	113
Issue O-11: Workforce Reduction.	115
Issue O-12: Workforce Distribution,	116
Issue O-13: Energy Cost	120
Human Factors.	121
Issue O-14: The Human Role	122
Issue O-15: Effects of Automation on Employees and Passengers,	127
CHAPTER 6: THE PLANNING AND DEVELOPMENT PROCESS . . .	133
Introduction	135
Issues	
Issue D-1: Design Concepts.	137
Issue D-2: System Development.	139
Issue D-3: Procurement Specifications	141
Issue D-4: Specification of Reliability, Maintainability, and Availability	142
Issue D-5: Equipment Suppliers.	144
Issue D-6: Contractor Selection.	145
Issue D-7: Contract Management,	147
Issue D-8: Testing,	148
Issue D-9: R&D Programs	150
Issue D-10: Test Tracks.	151
Issue D-11: Research Needs	153
CHAPTER 7: POLICY AND INSTITUTIONAL FACTORS	157
Introduction	161
Summary of Existing Legislation	161
Issues	
Issue P-1: Impact of Existing Legislation	163
Issue P-2: Regulation	166
Issue P-3: Acceptance Testing and Qualification	168
Issue P-4: Standardization,	169
Issue P-5: Safety Assurance	171
Issue P-6: Public Expectations	172
APPENDICES	
A. Train Control System Functions.	177
B. Automatic Train Control Technology	191
C. Design Characteristics of Selected Rapid Rail Transit Systems	199
D. Glossary of Train Control Terms.	207
E. Chronology of Train Control Development,	215
F. Persons and Organizations Visited.	221
G. Biographies of Urban Mass Transit Advisory Panel,	231
H. References.	235
I. Congressional Letters of Request	237

TABLES

		Page
TABLE 1.	Levels of Automation	40
TABLE 2.	BART System Facts.	46
TABLE 3.	CTA System Facts	51
TABLE 40.	MBTA System Facts	56
TABLE 5.	NYCTA System Facts	61
TABLE 6.	PATCO System Facts	66
TABLE 7.	Automated Feature of Three Transit Systems Under Development.	69
TABLE 8.	Train Protection Methods in Existing and Planned Transit Systems ... , ,	78
TABLE 9.	Analysis of CTA Accident Record, 1965-74, ... , ,	80
TABLE 10.	Passenger Injuries Due to Train Operation ., , , ... , ,	81
TABLE 11.	Passenger Accident Summary	82
TABLE 12.	Fatalities in the United States by Transportation Mode During 1973,	83
TABLE 13.	Passenger Assaults and Robberies for Selected Transit Systems	88
TABLE 14.	Train Operation Methods Related to Ride Quality. , .	92
TABLE 15.	Service Characteristics in Typical Transit Systems ..	94
TABLE 16.	Schedule Adherence in PATCO, 1970-74.....	96
TABLE 17.	Schedule Adherence on CTA Dan Ryan Line, 1970-74	96
TABLE 18.	Schedule Adherence in BART, August 1973-August 1974. .,	98
TABLE 19.	PATCO Car Component Performance, July-October 1974...0,0,00...60,	101
TABLE 20.	Summary of Disabling Equipment Failures in PATCO, August 1973-July 1974	102
TABLE 21.	Summary of Equipment Failure in BART, 1974 -75....	102
TABLE 22.	Car Component Performance on CTA West-South Route, July-October 1974.	104
TABLE 23,	Maintenance Time for Selected PATCO Car Compo- nents. ,	106
TABLE 24.	Capital Costs in New Transit Systems	110
TABLE 25.	Cost Estimates for ATC Equipment	111
TABLE 26.	Summary of Rail Rapid Transit Operating Costs..	113
TABLE 27.	Effect of Automation on Size of Workforce.	116
TABLE 28.	Analysis of Operations and Maintenance Workforce. .	118
TABLE 29,	Rail Rapid Transit Energy Consumption	120
TABLE 30.	Man and Machine Roles in Rail Rapid Transit Systems	124
TABLE 31.	Significant Dates in the Engineering Planning, Pro- curement, and Testing of ATC for Various Transit Systems	136

		Page
TABLE 32.	Type of Specification Used in Recent ATC Procurements	142
TABLE 33.	Contractor Selection Approaches	146
TABLE 34.	UMTA Budget for Fiscal Year 1976,	164
TABLE A-1.	Primary Means of Communicating Information Related to Train Control,	188

FIGURES

FIGURE 1.	Train Control System Functions, . . . ,	18
FIGURE 2.	Generalized Control Process	21
FIGURE 3.	Simple D.C. Track Circuit	22
FIGURE 4.	Three-block, Three-Aspect Wayside Signal System, .	24
FIGURE 5.	Cab Signals	26
FIGURE 6.	Three-block, Three-Aspect Cab Signal System. . . , .	26
FIGURE 7.	Cab Signal System With Automatic Overspeed Protection	27
FIGURE 8.	Automatic Train Operation System.	29
FIGURE 9.	Typical Interlocking Location. . . ,	30
FIGURE 10.	Entrance-Exit Interlocking Control Panel. ,	31
FIGURE 11.	Model Board and Train Control Console	32
FIGURE 12.	General View of Rail Rapid Transit Station	33
FIGURE 13.	Trip Stop	34
FIGURE 14.	Track Circuit Wiring.	34
FIGURE 15.	Wayside Equipment Case	34
FIGURE 16.	Track Apparatus at an Interlocking.	35
FIGURE 17.	Central Train Control Facility	35
FIGURE 18.	Two Views of a Central Control Facility With Electromechanical Equipment. . . ,	36
FIGURE 19.	Tower for Local Control of Interlocking.	36
FIGURE 20.	Carborne Receiver Coil for Coded Track Circuit Signals.	37
FIGURE 21.	Train Operator's Console for System With ATO	37
FIGURE 22.	Aerial View of Rail Rapid Transit Yard and Maintenance Facility. ,	38
FIGURE 23.	Rail Rapid Transit Car Maintenance Shop.	39
FIGURE 24.	BART Route Map	45
FIGURE 25.	BART Train in Underground Station	47
FIGURE 26.	Interior of BART Car	48
FIGURE 27.	BART Train Passing Through the Transbay Tube.	49
FIGURE 28.	CTA Route Map.	50

	Page
FIGURE 29.	CTA Train on the West-Northwest Route in the Median of the Kennedy Expressway.53
FIGURE 30.	Interior View of CTA Train53
FIGURE 31.	Lake-Dan Ryan Train Entering the Loop54
FIGURE 32.	MBTA Route Map.55
FIGURE 33.	MBTA Orange Line Train57
FIGURE 34.	Red Line Train Arriving at Wollaston Station.57
FIGURE 35.	The Old and the New.59
FIGURE 36.	NYCTA Route Map.60
FIGURE 37.	IND F Train on Elevated Line in Brooklyn ,63
FIGURE 38.	Examples of NYCTA Transit Cars,63
FIGURE 39.	The Graffiti Epidemic.64
FIGURE 40.	PATCO Route Map.65
FIGURE 41.	PATCO Train in Lindenwold Yard,67
FIGURE 42.	Outbound on the Benjamin Franklin Bridge68
FIGURE 43.	PATCO Train Operator Monitoring ATC Equipment68
FIGURE 44.	WMATA Route Map71
FIGURE 45.	MARTA Route Map.72
FIGURE 46.	Baltimore MTA Route Map.74
FIGURE 47.	Interlocking Control Tower for Train Protection79
FIGURE 48.	CTA Passengers Alighting at Belmont Station82
FIGURE 49.	History of Train Motion Accidents83
FIGURE 50.	Unmanned Train at Seattle-Tacoma Airport.85
FIGURE 51.	Fully Automated AIRTRANS Train86
FIGURE 52.	Approach to Brightly Lighted Station89
FIGURE 53.	Lonely Station at Off-Peak Hour89
FIGURE 54.	Comfort Features of Modern Transit Cars.92
FIGURE 55.	The Wait and the Rush To Leave95
FIGURE 56.	AIRTRANS Availability and Service Interruptions97
FIGURE 57.	Carbone and Wayside ATC Equipment100
FIGURE 58.	Maintenance of Transit Vehicle Truck.106
FIGURE 59.	Cab Signal Maintenance.107
FIGURE 60.	Car Washer.108
FIGURE 61.	Influence of Maintenance on Car Availability in BART, May 1974-January 1975109
FIGURE 62.	Transit System Construction.112
FIGURE 63.	Winter on the Skokie Swift Line114
FIGURE 64.	Reduction of Train Crew.117
FIGURE 65.	Proportion of Operations and Maintenance Employees in Total Workforce118
FIGURE 66.	Distribution of Maintenance Force as a Function of Automation.119
FIGURE 67.	State-of-the-Art Car121
FIGURE 68.	Student Conductors Training on the Job.122
FIGURE 69.	Motorman at Work123

	Page
FIGURE 70.	Line Supervisors.123
FIGURE 71.	Transit System Maintenance Workers129
FIGURE 72.	DOT Test Track, Pueblo, Colo..154
FIGURE 73.	ATC Research and Development Priorities and Relative Cost.156
FIGURE A-1.	Conceptual Diagram of an ATP System,178
FIGURE A-2.	Train Separation in a Conventional Block Signaling System ... ,180
FIGURE A-3.	Conceptual Diagram of Service Brake Flare-Out Control 185
FIGURE B-1.	Simple D.C. Track Circuit192
FIGURE B-2.	Simple Power-Frequency A.C. Track Circuit193
FIGURE B-3.	Simple High-Frequency A.C. Track Circuit.194
FIGURE B-4.	Alternate High-Frequency A.C. Track Circuit195

Chapter 1

FINDINGS

...
...
...
...
...

...
...
...
...
...

Definitions²

Train Control—the process by which the movement of rail rapid transit vehicles is regulated for the purposes of safety and efficiency. The system that accomplishes train control performs four types of functions:

Train Protection—assurance that trains maintain a safe following distance, that overspeed is prevented, and that conflicting movements at junctions, crossings, and switches are precluded;

Train Operation—control of train movements—specifically regulating speed, stopping at stations, and opening and closing doors;

Train Supervision—assignment of routes, dispatch of trains, and maintaining or adjusting schedule;

Communication—interchange of command and status information among trains, wayside elements, stations, and central control.

Automatic Train Control (ATC)—the use of machines to perform all or most of the functions of train control in the normal mode of operation. Human involvement in ATC systems consists mainly of monitoring and back-up. The acronyms ATP (automatic train protection), ATO (automatic train operation), and ATS (automatic train supervision) denote particular groups of automated functions.

Rail Rapid Transit—an electrified rail system operating in urban areas on exclusive rights-of-way. Rail rapid transit is considered here to exclude commuter railroad systems and light rail systems, although the technology of train control is similar for all three.

²A glossary of train control terms is presented in Appendix D. Explanation of the fundamentals of train control and descriptions of typical train control equipment are contained in Chapter 3.

INTRODUCTION

In requesting this assessment, the Senate Committee on Appropriations posed four major questions concerning automatic train control technology:

1. What is the state of ATC technology?
2. What application is made of ATC technology in existing and planned rail rapid transit systems?
3. Are the testing programs and methods for ATC systems adequate?
4. How is the level of automation selected, and what tradeoffs are considered?

These questions served initially as the basic framework for organizing and directing the assessment. As the study progressed, it became apparent that each issue raised by the requesting committee had many ramifications and that there were corollary questions that had to be addressed. Therefore, the study was expanded in scope and detail to consider not just the matters enumerated in the letter of request but, more generally, the entire field of automation technology in train control systems. The findings of this broader investigation dealing with policy, planning, and operational concerns are summarized below. Supporting data and discussion are presented in chapters 5, 6, and 7. At the conclusion of this chapter is a brief interpretation of the findings that responds directly and specifically to the issues raised by the Senate Committee on Appropriations.

POLICY AND INSTITUTIONAL FACTORS

The development of rail rapid transit systems is influenced by three major pieces of Federal legislation: the Urban Mass Transportation Act of 1964, the Department of Transportation Act of 1966, and the National Mass Transportation Assistance Act of 1974. Transit system planning, development, and (since 1975) operation are supported by these acts and the annual appropriations that flow from them. The administrative agency for Federal support of transit development programs is the Urban Mass Transportation Administration (UMTA). Neither the existing legislation nor the administrative programs of UMTA deal specifically with ATC systems as such. Research in train control technology and development of individual ATC

systems are carried on within a more general program of activities relating to rail rapid transit as a whole.

Findings pertaining to policy and institutional considerations are as follows:

Regulation

At the Federal level, regulation of rail rapid transit (and ATC specifically) is of recent origin. Regulation is vested in two agencies—UMTA and the Federal Railway Administration (FRA), whose respective areas of responsibility are not clearly defined. It is not surprising, therefore, that so far neither agency has done much to regulate or standardize ATC systems. However, FRA has recently indicated the intention to start rulemaking procedures concerning ATP and the safety aspects of door operation.

The National Transportation Safety Board (NTSB) is charged with overseeing rail rapid transit safety and with accident investigation. Implementation of NTSB recommendations is left to either FRA or UMTA or is handled as a matter of voluntary compliance by transit agencies.

Most regulation of rail rapid transit (and ATC specifically) is carried out either by State public utility commissions or by the transit agencies themselves as self-regulating bodies. The concern of State regulatory bodies is primarily safety. Little attention is given to operational concerns, such as reliability, maintainability, level of service, efficiency, and economics.

Advantages in increased Federal regulation, particularly in the areas of safety assurance and equipment standardization, must be weighed carefully against the disadvantages of preempting State and local authority and raising possible barriers to innovation.

Institutions

Decisions relating to ATC design and development are influenced by several nongovernmental institutions or groups. The strongest influence is that of the local planning or operating authorities, which rely heavily on engineering and technical consultants employed to assist in planning and development activities.

Other institutions and groups acting to shape the course of ATC design and development are equip-

ment manufacturers, industry associations, and organized labor. Except in isolated cases, only the equipment manufacturers exercise any significant influence during the ATC design and development process. The influence of labor is usually brought to bear only as a new system is being readied for operation and a contract with the union local is being negotiated.

Community planners, public-interest groups, and the public at large play only a small role in the design and development of ATC systems. There is some evidence that these groups may be assuming more influence, not in technical concerns, but in the area of establishing priorities and general service characteristics.

Policy Impacts

Federal policy from 1964 to 1974 may have tended to encourage the development of new, technologically advanced transit systems employing highly automated forms of train control. In part, this policy appears to have stemmed from the expectation that automation would lead to increased productivity—a benefit that, in the case of ATC, has not been substantiated. This policy may be in the process of change as a result of the National Mass Transportation Assistance Act of 1974.³

Transit agencies, when planning new systems, have also been inclined to favor technological advancement—partly as a reflection of how they perceived Federal Government policy and partly because they or their consultants believed advanced technology was necessary to win public support for development and patronage of the system.

This situation has created a tendency for system designers to turn to highly automated forms of train control as a means of offering improved performance and service. The superiority of automated over manual methods of train control is not certain, however, except in the area of train protection (ATP).

The public appears to attach greater importance to dependability of service and personal security than to ATC system performance characteristics.

³The OTA study, *An Assessment of Community Planning for Urban Mass Transit*, February 1976 (Report Nos. OTA-T-16 through OTA-T-27), deals extensively with the history and current trends of planning and public policy in mass transit.

The cost of automatic train control has negligible influence on the public primarily because it is small in relation to the total cost of the system (typically between 2 and 5 percent). A question on train control system automation, as a specific issue, has never been submitted to the public for decision by referendum.

THE PLANNING, DEVELOPMENT, AND TESTING PROCESS

The evolution of a rail rapid transit system from concept to start of revenue service may span 10 to 20 years. The process has three major phases: planning, engineering development, and testing. Research and development to support design are conducted throughout but tend to be concentrated in the middle phase, where detail design and development takes place. The design and engineering of the train control system, while generally concurrent with the development cycle of the whole transit system, is usually neither the pacing item nor a dominant technical concern.

Findings concerning the planning, development, and testing process for ATC systems are as follows:

Planning

Formulation of the ATC design concept and determination of the extent to which the system will be automated are greatly influenced by non-technical factors, notably social and political concerns, the prevailing attitude of decisionmakers and system designers toward technological innovation, and reaction to the recent experience of other transit agencies.

Cost-benefit analyses conducted during the system design process seldom, if ever, include evaluation of alternative ATC concepts and different levels of automation, perhaps because ATC represents only 2 to 5 percent of total system cost and benefits are not easily quantified.

The comparative operational costs of alternative levels of ATC are given very little consideration.

Engineering Development

ATC procurement specifications vary greatly in terms of approach and level of detail; but the trend in newer systems is toward a more quantitative form of specification, particularly for reliability, maintainability, and availability requirements.

There is a recognized need in the transit industry for improvement in the writing of specifications and in setting realistic requirements for reliability, maintainability, and availability.

In new transit systems, the ATC equipment is procured as a package through a single contractor. In existing transit systems, ATC equipment is often acquired piecemeal as additions or improvements to equipment already in operation.

In most instances, contractor selection is based on low bid from technically qualified competitors. This procedure is usually required by State law or local ordinance. Noncompetitive procurement is seldom used, except for a follow-on to an earlier contract.

Testing

Testing is conducted at several points in the development process, generally for one of three purposes: qualification and validation of component and subsystem design, assurance of conformity to specification, and demonstration of total system performance prior to final acceptance and start of revenue service.

Performance verification and acceptance testing of train control systems, coming near the end of the development cycle, may be slighted because of pressure to open the system for service. The pre-operational test program may be either abbreviated or deferred until after the start of revenue service and often extends into the first year of operation or longer.

The quality and extent of assurance and acceptance testing vary greatly among transit systems, largely as a function of the qualifications and experience of the organization managing the development of the system. There is a need for more detailed and comprehensive test plans, more clearly defined criteria and methods of measurement, more rigorous procedures for conducting tests, and more complete documentation of test findings.

Research and Development

There are no test tracks and experimental facilities for carrying out R&D activities related to train control, except at individual transit systems or at a manufacturer's plant as part of a product development program. The Pueblo facility does not permit detailed study of ATC design and engineering problems in a realistic operational setting.

The state of ATC technology is such that the greatest R&D need is refinement of existing designs and not development of innovative or more advanced technology. Yet, relatively little R&D effort is concentrated on presently known operational problems, such as reliability, maintainability, and availability, performance testing methods and standards, and development of a uniform data base on ATC system performance.

OPERATIONAL EXPERIENCE

No rail rapid transit system now operating or under development in the United States has a train control system that is completely automatic. All employ some mixture of manual and automatic control, and all have at least one person on board the train to carry out some control functions. Only two rail rapid transit systems operating in the United States at the end of 1975—BART in San Francisco and the PATCO Lindenwold Line in Philadelphia and suburban New Jersey—are automated to the extent that the trainman has little or no direct part in operating the train. In all other U.S. rail rapid transit systems, trains are operated manually, with automation employed only for train protection and some supervisory functions. New transit systems being planned and developed in Washington, Baltimore, and Atlanta show the influence of BART and PATCO with respect to both the level of automation and the use of advanced ATC technology.

A survey of the operational experience with ATC leads to the following findings:

Safety

Automatic Train Protection (ATP) systems are superior to manual methods of preventing collisions and derailments, principally because ATP safeguards against human error and inattention. The use of ATP is becoming universal in the U.S. transit industry.

Automatic Train Operation (ATO) offers no clear safety advantages over manual modes of operation.

Automatic Train Supervision (ATS) does not produce additional safety benefits beyond those attainable with traditional manual or machine-aided forms of supervision carried out by dispatchers, towermen, and line supervisors.

In conjunction with increased automation, the size of the train crew is often reduced to one. One-man operation does not appear to have an adverse effect on passenger security from crime or on protection of equipment from vandalism.

Performance

Under normal operating conditions, the ride quality provided by ATO is comparable to that of manually operated trains. The principal advantage of ATO is that it eliminates variation due to the individual operator's skill and provides a ride of more uniform quality. Manual operation is considered to be the more effective mode of control under certain unfavorable weather and track conditions.

Systems with ATC have experienced problems of schedule adherence during the start-up period, but it is not certain how much of this is a result of train control automation and how much is due to other factors such as the complexity and reliability of other new items of transit system equipment.

Reliability of ATC equipment has been a major operational problem. Failure rates for both wayside and carborne components have been higher than anticipated, but not greater than those of other transit system components of comparable complexity and sophistication (e.g., communications equipment, propulsion motors, electrical systems, air-conditioning equipment, and door-operating mechanisms).

Maintenance of ATC equipment, like other items of new technology, has been troublesome because of longer repair time, more complicated troubleshooting procedures, higher levels of skill required of maintenance personnel, and the lack of people with these skills. A shortage of spare parts has also hindered maintenance efforts.

On the whole, however, ATC equipment contributes proportionally no more to vehicle downtime or service interruptions than other transit system components. The problem is that ATC, like any other new element added to a transit system, has an effect that is cumulative and tends to lower the general reliability of the system.

costs

ATC typically accounts for 2 to 5 percent of the capital cost of rail rapid transit; the variation is almost directly proportional to the level of automation,

Because of the reduction in train crew that often accompanies ATO and because of the centralization and consolidation of train supervisors brought about by ATS, automated systems are somewhat cheaper to operate than manual systems. These savings are offset, however, by the increased labor costs of maintaining ATC equipment. In comparison with manual systems, the maintenance force for ATC systems is larger, skill requirements and the corresponding salary levels are higher, training of technicians must be more extensive and hence costly, and repairs are more frequent and take longer. The combined operation and maintenance costs of automated systems are about the same as those of manual systems. There is no evidence that ATC systems lead to more efficient train operation or to any significant change in energy consumption. Vehicle weight, route layout, and propulsion system characteristics are far more dominant factors in energy use than automated or manual operation.

Human Factors

Monotony and light responsibility make it difficult for operators of highly automated systems to maintain vigilance. There has also been a tendency for ATC system designers, notably in BART, to make insufficient use of the human operator to back up or enhance automatic system performance. The designers of systems now under development are seeking to integrate the operator more effectively into the ATC system, to give man a more meaningful set of responsibilities, and to make automatic equipment more amenable to human intervention.

For maintenance employees and train supervision personnel, ATC systems impose new and higher skill qualifications and more demanding performance requirements.

The effect of automation on passengers is negligible, except insofar as it maybe more difficult for them to obtain information with fewer transit system employees on the train.

ASSESSMENT OF ATC TECHNOLOGY

The following is an analysis and interpretation of the findings in light of the concerns expressed in the letter of request from the Senate Committee on Appropriations.⁴

⁴This letter and related correspondence are contained in appendix I.

The State of ATC Technology

ATC technology is a mature technology insofar as train protection (ATP) and train operation (ATO) functions are concerned. The major difficulties encountered in these areas have arisen from the application of new, unproven techniques that represent departures from conventional train control system engineering. Train supervision (ATS), except for certain well-established dispatching and routing techniques, is the least advanced area of ATC technology. Research and development efforts are now underway to devise computer programs and control techniques to permit comprehensive, real-time supervision and direction of train movement by automated methods.

Operational experience indicates that automatic train protection (ATP) enhances the safety of a transit system because it safeguards against collisions and derailments more effectively than manual and procedural methods. Performance and service characteristics of ATC systems are as good as, and perhaps better than, manual systems once the somewhat lengthier period of debugging and system shakedown has passed. Reliability and maintenance continue to be serious problems for systems using higher levels of ATC and probably account for an increase in operating costs that outweighs any manpower savings achieved through automation.

Application of ATC Technology in New Systems

In assessing the application of technology in new transit systems, a distinction must be made between train protection (ATP) and train operation and supervision (ATO and ATS). All systems—old, new, and planned—rely on automatic devices to accomplish train protection functions. Two forms of technology are employed. One uses wayside signals with trip stops, the other uses cab signals. The trend in the transit industry today is toward cab signaling, which is the newer technology, because it offers somewhat more flexible protection than wayside signaling, and because it provides an evolutionary path to partially or fully automated train operation. The new systems in Washington, Atlanta, and Baltimore and the recent extensions to existing systems (e.g., the CTA Dan Ryan extension and the MBTA Red Line) all employ cab signaling and the more automated forms of operation derived from it.

With regard to ATO and ATS, the new systems under development and those in the planning stages will employ more advanced technology and higher levels of automation than those built and put in operation before 1969. With some exceptions, such as door closure or train starting, train operation in the new systems will be entirely automatic, but supervised by an on-board operator who will intervene in case of emergency or unusual conditions. Central control functions (ATS) will be assisted, or in some cases accomplished entirely, by automatic devices. Thus, train operation and supervision in new systems will resemble those of PATCO and BART, and the general trend is toward extensive use of ATO and ATS.

There is almost no research and development now in progress to produce new ATC technology for rail rapid transit. The development work currently underway is devoted primarily to refinement of existing techniques and their application in particular localities. The transit industry has watched closely the experience of BART and PATCO. The results of the PATCO approach, which made use of conventional technology, have been compared to those of BART, where innovative technology and more extensive automation were employed. The designers of the Washington, Atlanta, and Baltimore systems have generally opted for a middle ground with regard to automation and have followed a cautious approach to new technology, inclining more toward PATCO than BART. Particular care has been given to the role of the human operator in backing up or augmenting the performance of ATO and ATS equipment. The experience of BART and PATCO has also led the newer systems to give careful attention to the reliability and maintainability of ATC equipment and to developing strategies for assuring system performance in adverse conditions or degraded modes of operation. It is certain that WMATA, the next of the new systems to be put in operation, will be scrutinized by the transit industry for other lessons to be learned.

The Testing Process

As train control systems have grown more complex, the testing process has been burdened in two ways: there are more elements that must be tested from prototype through final installation, and there are more interrelationships that must be checked out before the system can be placed in revenue service. The problem of testing is especially

difficult in a new transit system, where all the equipment is new and untried and where all the parts need to be tested before initiating passenger operations.

The experience of BART has underscored both the basic need for testing and the importance of giving careful attention to test methods, procedures, and documentation of results. The application of new technology on a large scale in a transit system involves more than just development and installation of equipment; it also involves the application of management techniques to integrate the parts of the system and to test and evaluate the performance of these parts, singly and in the system as a whole. Perhaps the greatest shortcoming in the area of testing in the transit industry today is the lack of a satisfactory method for comprehensive evaluation of transit system performance, under realistic conditions, in the preoperational period. This is often compounded by political, social, and economic pressures to open the system for revenue service as soon as possible, with the result that the test program may be truncated or deferred until after opening day and the full certification of the system may not come until months or years later.

The managers of the new systems under development appear to be mindful of these problems. Improved testing methods and procedures are being devised. More complete programs of preoperational testing, even at the expense of postponing revenue service, are being planned. An incremental approach to testing and full system operation has been adopted, with each step building on the results of earlier phases and with testing timed to the pace of system growth. Methods of testing in revenue service, both in regular hours of operation and during nighttime periods, are being explored. More attention is being given to documentation of test plans and results.

Selecting the Level of Automation

There is no single procedure for selecting the type of train control system and the level of automation. Individual transit authorities follow rules of their own devising. Some rely on the advice of consultants; others draw upon the experience of their own technical staff. Only a few generalizations can be made about the nature of this process.

The decisionmaking process does not appear to

be deeply analytical. Criteria of choice are not often defined, the rules of choice are not made explicit, and the analysis of alternatives is not documented except in a fragmentary fashion by internal memoranda and working papers.

Established transit systems, where extensions or new lines are being planned, give considerable attention to the engineering characteristics of the proposed train control system, primarily to assure that new ATC equipment can be successfully integrated with other parts of the existing system. In this case, engineering criteria serve primarily as constraints upon the type of ATC equipment that can be used or upon the level of automation to be selected. The established rules and procedures of the transit system act in much the same way to limit the choice of design alternatives. But there is no evidence to indicate that the planning and design process includes studies directed specifically at determining an optimum train control system or at balancing train control system design features against the service and operating characteristics of other equipment or of the transit system as a whole.

In new transit systems, the process for selecting a train control system is governed even less by system engineering and trade-off studies. The level of automation appears to be selected, more or less arbitrarily, early in the system development cycle. It is treated more as a postulate or a design goal than as a point for analysis and trade-off. It also appears that characteristics of the proposed ATC system are derived more from general, nontechnical decisions about the nature of the whole system and its desired service features (speed, headways, station spacing, etc.) than from technical considerations of control system design or automation technology.

During the planning process, the development and acquisition costs of ATC equipment are considered, but formal cost-benefit studies specific to the ATC system are usually not conducted. ATC costs—and, to a lesser extent, benefits—are sometimes factored into cost-benefit studies for the transit system as a whole; but the objective of these studies is to analyze other aspects of the system or to justify a more general choice regarding transit mode, system size, or route structure. The operational costs of ATC are seldom included in system cost-benefit studies, and they are not subjected to separate analysis to determine their potential influence on the life-cycle costs of the transit system,

Chapter 2

BACKGROUND

RAIL RAPID TRANSIT

Rail rapid transit is an old and established part of the national transportation system. It carries large numbers of people at high speeds within central business districts and to and from outlying areas. The patronage in Chicago, for example, is over half a million people on a typical weekday; in New York City as many as 3-1/2 million riders are carried daily. Nationwide, rail rapid transit serves about 2 billion passengers per year. In the newer systems, top speeds of 70-80 miles per hour are attained, with average speeds of 30-40 miles per hour for an entire trip. In cities where there is an existing rail rapid transit system, it is difficult to conceive how they could function properly, or at all, without this mode of transportation.

Most rail rapid transit systems in this country were built over 30 years ago. The New York, Boston, and Chicago systems date from the turn of the century. In recent years, other major cities have turned to rail rapid transit as a solution to the problems of urban transportation and automobile traffic congestion. The Lindenwold Line (PATCO) in New Jersey and BART in San Francisco were built within the last 10 years, and rail rapid transit systems are planned or under construction in Atlanta, Baltimore, and Washington, D.C. The major cities with existing systems (New York, Chicago, Boston, Philadelphia, and Cleveland) have undertaken programs to extend and improve their service.

Along with the new attention to rail rapid transit has come an increased concern with technology. The basic technology of rail rapid transit, which derives largely from railway engineering, is quite old. Propulsion and braking systems, for example, are products of the late nineteenth century. The electric track circuit, used to detect the presence of trains and to assure safe separation of trains, was developed over 100 years ago. The cam controller (a mechanism for controlling the application of power to d.c. propulsion motors) was first used in the Chicago subway system in 1914. Cab signaling systems, functionally similar to those of today, were in use in the 1930's. While this technology has been refined and improved over years of operational experience, many transit system planners and

⁵Rail rapid transit is an electrified rail system operating in urban areas on exclusive rights-of-way. Rail rapid transit is considered here to exclude commuter railroad systems and light rail systems, although the technology of train control is similar for all three.

engineers believe that new and more sophisticated forms of technology need to be applied in order to achieve systems of higher safety, performance, and efficiency,

Generally, two avenues of technological innovation are proposed for rail rapid transit: substitution of electronic for electromechanical components and more extensive use of automation. One such application of new technology is in the area of train control, where the replacement of men with electronic monitoring and control mechanisms is thought to offer several advantages--greater consistency of performance, safeguarding against human error, more extensive and precise control of train operations, and reduced labor costs in operating the system. However, some transit engineers have misgivings about the ability of the newer automatic train control systems to perform as safely and efficiently as manual systems. There is also some doubt about the cost-benefit of automation. Automated control systems are more expensive to design and produce, and their complexity may make them less reliable and more costly to maintain. Automatic train control is, thus, a controversial matter in rail rapid transit, especially as a result of the difficulties encountered by the BART system in San Francisco. BART is the newest and most technologically advanced transit system in the United States, but it has not yet lived up to the levels of performance and service predicted during its planning and development, or even to the standards set by older and technologically less advanced transit systems now in operation. Some critics contend that problems of BART stem from its extensive use of unproven innovative technology for train operation and control,

A part of the controversy over automation may stem from a common misconception that it is synonymous with computers. Electronic data processing is certainly one way to achieve automatic operation, but there are others. The track circuit, the electromechanical relay, the emergency air brake, the trip stop, and recorded passenger information announcements are all automatic devices; and none involves a computer in the usual sense of the term. Another misconception is that automation is something new, a product of aerospace technology. While it is true that automated equipment has been employed extensively in advanced aviation and space systems, the birthplace was certainly not there. Automation has been with us since the beginning of the industrial revolution. All of the

automatic devices mentioned above have been in use in rail rapid transit for many years.

Thus, the issue is not whether automation should be applied in rail rapid transit train control. Automatic train control devices of various types have been used in rail rapid transit for many years. The real concerns are where should automation be applied, how far should the train control process be automated, and what technology should be used. As phrased by the OTA staff in planning this assessment of automatic train control in rail rapid transit, the central question is: "What degree of system automation is technically feasible, economically justifiable, or otherwise appropriate for rail rapid transit?" The answer, which entails examination of safety, performance, and cost, is crucial to the future development of rail rapid transit and its value as a public transportation system.

OBJECTIVES

This study was undertaken with the following objectives:

1. to examine the design characteristics of automatic train control systems and evaluate the state of automatic train control technology;
2. to assess the operating experience and performance of transit systems which employ various forms of automatic train control;
3. to analyze the process by which automatic train control systems are planned, developed, and tested;
4. to examine the policy and institutional factors that influence the application of automatic train control technology in rail rapid transit.

Thus, the emphasis of this report is not on technology as such. While there is considerable attention given to technical matters in the early chapters, it is intended as background for subsequent examination of the results and implications that ensue from the application of automation in rail rapid transit systems. The bulk of this report is devoted to an assessment of the practical results of ATC in operating transit systems and to the practical results of ATC in operating transit systems and to an evaluation of the planning and development proc-

ess by which ATC systems evolve in the context of public institutions and government policy.

SCOPE

The scope of this report is limited to automatic train control technology in rail rapid transit systems. No attempt has been made to deal either with rail rapid transit technology as a whole or with the application of ATC to small-vehicle fixed-guideway systems.⁶ The parts of this report that deal with the planning and development process are confined to matters relating to the evolution of the train control system. It is recognized that ATC design and development does not occur in isolation, but as a part of the larger process by which the entire transit system is planned and built. A more general assessment of mass transit planning is the subject of a separately published report.⁷

Five operating rail rapid transit systems are examined in this report:

Bay Area Rapid Transit System (BART) in the San Francisco area,

Chicago Transit Authority (CTA),

Massachusetts Bay Transportation Authority (MBTA) in the Boston area,

New York City Transit Authority (NYCTA),

Port Authority Transit Corporation (PATCO), the Lindenwold Line, in Philadelphia and suburban New Jersey.

These systems were selected for study because they embrace a broad range of system characteristics. They vary from a simple one-line system (PATCO) to complex and dense transit networks (CTA and NYCTA). They represent a range of automation, from predominantly manual (NYCTA and CTA) to highly automated (BART). They differ greatly with respect to age--NYCTA, MBTA, and CTA being the oldest and PATCO and BART the newest. They also employ several forms of train control technology--conventional (CTA, MBTA, NYCTA), advanced (PATCO), and innovative (BART).

⁶An assessment of the technology of transit systems employing automatically operated small vehicles on fixed guideways was issued by OTA in June 1975 under the title, *Automated Guideway Transit* (Report No. OTA-T-8).

⁷An Assessment of Community Planning for Mass Transit, Office of Technology Assessment, February 1976 (Report Nos. OTA-T-16 through OTA-T-27).

In addition to these five operating systems, others in the planning and development stage are considered in the parts of the report that deal with the process by which transit systems are conceived, designed, and built. The principal rail rapid transit systems under development are:

Metropolitan Atlanta Rapid Transit Authority
(MARTA)

Mass Transit Administration (MTA) in
Baltimore

Washington Metropolitan Area Transit
Authority (WMATA)

STUDY METHOD

This assessment was a joint undertaking by the OTA Transportation Program Staff and the Urban Mass Transit Advisory Panel, an 11-member group made up of representatives of the transit industry, State department of transportation, planning consultants, organized labor, and public-interest groups. Battelle Columbus Laboratories acted as technical consultants and provided major assistance in collecting data and conducting interviews with transit system officials, planning organizations, and equipment manufacturers. The OTA staff also carried out an independent program of visits to interview transit system officials at five sites and to collect data on their operational experience with ATC equipment. The findings of the Battelle investigation were presented to the panel in a series of background and technical documents. This material was combined with the results of the OTA staff effort to form the basis for this technology assessment.

ORGANIZATION

This report is organized to accommodate readers of different interests and technical backgrounds. The next two chapters, entitled "Automatic Train Control" and "Transit System Descriptions," are intended to acquaint the reader with basic train control technology and the operational characteristics of the rail rapid transit systems selected for study. These chapters are written with a minimum of technical detail and provide a general background for the subsequent examination of operational, planning, and policy issues. Those already familiar with train control technology and transit operations may wish to skim this material or to pass on directly to chapters 5, 6, and 7, which deal with operational experience, planning and development, and policy issues relating to automatic train control technology. As an accommodation to differing reader interests, these chapters are organized in three levels of detail. The first level is a summary of the major issues at the beginning of each chapter. Next is a presentation of the individual issues, each headed by a capsule statement and a synopsis of the principal findings and conclusions. The third level consists of supporting detail and discussion of the implications for each issue. Thus, the reader can pursue each topic to whatever depth desired.

At the end of the report are various technical appendices, intended primarily for those who wish more specific information on train control technology and system engineering features. Appendix D—Glossary of Terms, and Appendix E—Chronology of Train Control Development, may also be of interest to the general reader.

Chapter 3

AUTOMATIC TRAIN CONTROL

Train control is the process by which the movement of rail rapid transit vehicles is regulated for the purposes of safety and efficiency. The process is carried out by a combination of elements—some men, some machines—located on the train, along the track, in stations, and at remote central facilities. These elements interact to form a command and control system with four major functions:

- . Train Protection prevention of collisions and derailments,
- . Train Operation control of train movement and stopping at stations,
- Train Supervision direction of train movement in relation to schedule,
- . Communication interchange of information among the elements of the system.

The train control system is analogous to the sensory organs and central nervous system of the human body. It senses and processes information, makes decisions, and transmits commands. Also as in the human body, the execution of commands is not a function of the train control system but of other parts specialized for that purpose. For example, the train control system may sense train speed, determine that it should be increased, provide an appropriate command signal to the motors, and monitor to see that the desired result is achieved. The means by which a speed change is effected, however, are not part of the train control system. All the equipment for getting electric power to the wayside, bringing it into the train, converting it to mechanical energy, and providing tractive effort is external to the train control system. Similarly, the equipment to select a route for a particular train and transmit commands to aline switches accordingly are within the train control system, but the parts of the trackwork that actually move (the switch points) are not elements of the train control system.

TRAIN CONTROL SYSTEM FUNCTIONS

Presented below is a description of the specific functions performed by a train control system and

of the way in which functional elements interact. These functional relationships are also illustrated by the diagram in figure 1. Since the purpose is only to provide the reader with a general background for understanding the nature of train control, the definitions presented here are brief and nontechnical.⁸

Train Protection

Train protection is a family of functions whose purpose is to assure the safety of train movement by preventing collisions and derailments.⁹ Train protection functions and requirements override all other control system functions either through equipment design or, in a completely manual mode, by rules and procedures. The functions that make up train protection are:

Train detection—monitoring of the track to determine the presence and location of trains;

Train separation—assuring that trains on the same track maintain a safe following distance to prevent collisions;

Route interlocking—preventing trains on crossing, merging, or branching routes from making conflicting (unsafe) moves that would cause a collision or derailment;

Overspeed protection—assuring that train speed remains at or below the commanded or posted civil speed limit¹⁰ as to prevent collisions resulting from going **too** fast to stop within the available distance and to prevent derailments due to excessive speed on curves or through switches;

Train and track surveillance—observing conditions on and in the vicinity of the track ahead of the train and monitoring safety-related conditions on board the train.

Train Operation

Train operation consists of those functions necessary to move the train and to stop it at stations

⁸F. For more detailed technical descriptions of train control system functions and technology, see appendices A and B.

⁹There is no **universally** accepted terminology and scheme of definitions for train control system functions **within the** transit industry. The terms and classification employed here are based on several sources and represent the best of current usage.

¹⁰A glossary of train control and rail rapid transit terms is provided in appendix D.

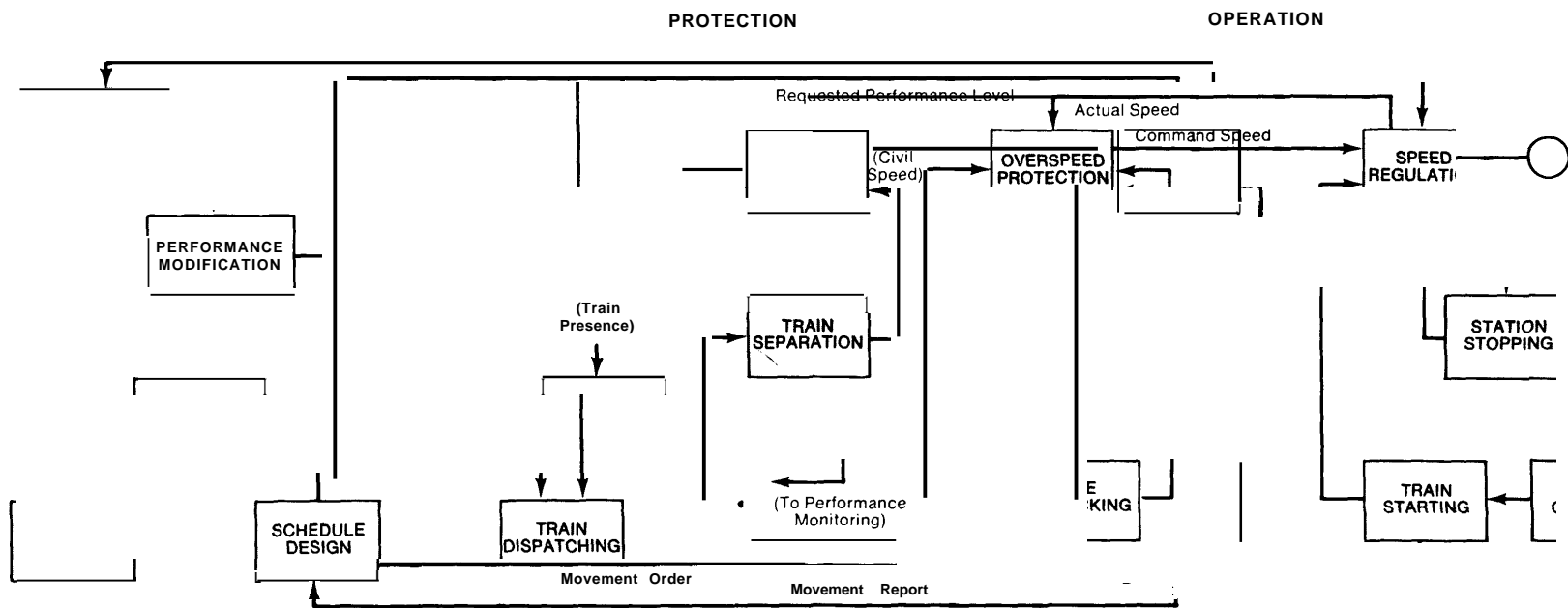
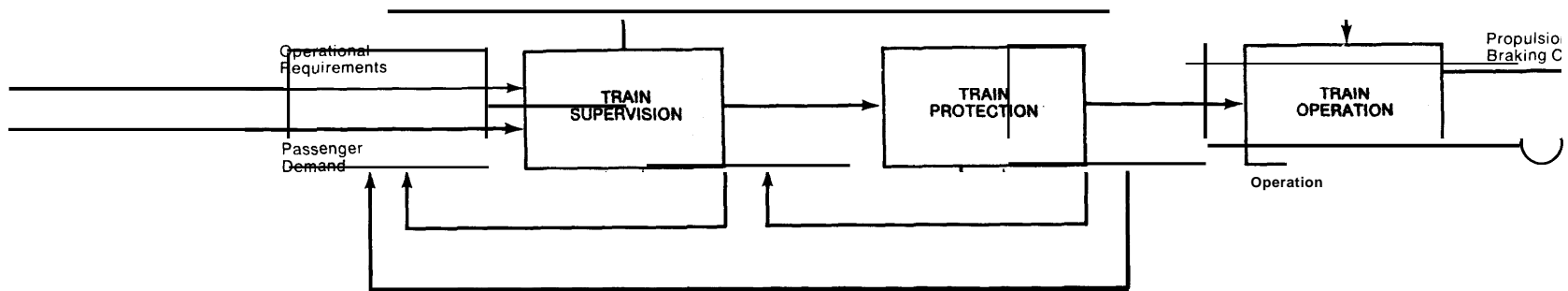

* To simplify the diagram, the functions of Alarming and Recordkeeping are not shown

FIGURE 1.—Train Control System

to board and discharge passengers. Train movement, as controlled by train operation functions, is under the direction of train supervisory functions and always within the constraints of train protection functions. Train operation involves the following:

Speed regulation—controlling train speed, within the constraints of overspeed protection, to make the run according to schedule;¹¹

Station stopping—bringing the train to a stop within some specified area in a station;

Door control—opening of doors in stations to permit passengers to enter or leave the train and closing of doors when the train is ready to start;¹²

Train starting—initiating train departure from a station after the doors are closed (and provided the train protection system permits it),¹³

Train Supervision

Train supervision involves monitoring the movement of individual trains in relation to schedule and route assignments and overseeing the general disposition of vehicles and flow of traffic for the system as a whole. The train supervision system may thus be thought of as making strategic decisions which the train operation system carries out

¹¹Speed regulation involves more than matching actual to command speed. It also includes control of acceleration, jerk limiting (controlling the rate of change of acceleration), slip-slide control (correction of wheel spinning during acceleration and skidding during braking), and flare-out (gradual relaxation of braking effort as the train comes to a stop). Flare-out is considered by some transit engineers to be a subsidiary function of speed regulation, and hence part of the train control system. Acceleration control, jerk limiting, and slip-slide control are regarded by transit engineers to be propulsion and braking system functions, but they are mentioned here because of their relationship to the train control functions of speed regulation and station stopping.

¹²The mechanisms that actually open and close doors are not part of the train control system, but the signals to actuate these mechanisms and the interlocks to assure that doors are closed before starting and that they remain closed while the train is in motion are generated within the train control system. Because of the safety implications of door control, some transit engineers consider it to be a part of train protection.

¹³Train starting is sometimes classified as part of the door control function. It is separated here for two reasons: (1) in some automated systems, door control is automatic while train starting is retained as a manual function; (2) in manual systems, the door control and train starting functions are often assigned to different persons.

tactically. In addition, train supervision includes certain information processing and recording activities not directly concerned with train safety and movement but necessary to the general scheme of operations. Train supervision functions are:

Schedule design and implementation—preparing a plan of service in light of expected demand, available equipment, and environmental conditions and issuing a schedule to implement the plan;

Route assignment and control—selecting and assigning routes to be followed by trains (and rerouting as necessary);

Train dispatching—controlling train departures from terminals or waypoints in accordance with the schedule;

Performance monitoring—following the progress of trains against the schedule by obtaining periodic updates of train identity, location, and destination;

Performance modification—adjusting movement commands and revising the schedule in response to train, traffic, and environmental conditions.

Alarms and malfunction recording—alerting to malfunctions, breakdowns, or problems, and recording their time, location, and nature;

Recordkeeping—maintaining operational logs and records for business and payroll purposes, for scheduling maintenance, for ordering supplies and equipment, and for computing technical statistics.

Communication

The communication system is the means by which the information needed to carry out all other train control functions is transmitted and exchanged.¹⁴ This information may take any of several forms—voice, visual, auditory, and digital

¹⁴On the function diagram in figure 1, communication functions are indicated by the lines connecting the boxes which represent train protection, operation, and supervision functions,

or analog electrical signals.¹⁵ Unlike other train control functions, which involve information processing and decisionmaking, communication is largely a facilitative process—serving to convey information but without producing any unique functional outcomes of and by itself. For this reason, the categorization given below indicates not functions as such but major classes of information that must flow throughout the system in order for other train control functions to take place:

Train protection—information necessary to locate individual trains, to assure their safe separation, to prevent overspeed, and to control movement at route interlockings;¹⁶

Command and status—information on the operational state of the system, command signals to control train and switch movement, and feedback to determine the response of system elements to command inputs;¹⁶

Emergency—information on the nature and location of emergency events and summons for help to elements within the transit system or to outside agencies (e.g., fire, police, medical, and rescue);

Passenger service—information relating to train service and system operation for the purpose of assisting passengers using transit facilities;

Maintenance—information needed to plan or conduct preventive and corrective maintenance;

Business operations—operational information used to maintain a record of (and to plan for) work force allocation, vehicle utilization, procurement of supplies and equipment, operating expenses, and system patronage.

¹⁵Some transit engineers limit the definition of communication to verbal or visual communication (radio, telephone, TV, and the like). Machine-to-machine communications, since they tend to be very specialized, are considered part of the function which they serve. This seems to be unnecessarily restrictive and makes an artificial distinction between information exchange by human operators and other forms of information exchange involved in operating the system (i.e., man to machine or machine to machine). The definition offered here is generic and embraces all types of information flow, regardless of how effected.

¹⁶Customarily, this part of the communication system is completely separate from the network used for other types of information and is considered to be an integral part of the train protection system.

AUTOMATION

At one time or another, all of the train control functions listed above have been performed by human operators, and many still are, even in the most technologically advanced transit systems. Theoretically, any of these functions could also be performed by automatic devices, and more and more have, in fact, been assigned to machines over the years. Before examining the technology by which train control automation has been achieved, it is first necessary to consider what is meant by automation and to clarify the terminology used in this report.

Figure 2 is a generalized diagram of the process by which any train control function is accomplished. It involves receiving information about some operational state of the system and some desired state. This information must then be interpreted—for example, by comparing the two states and deriving a quantitative expression of the difference. Next, an appropriate control response to null the difference must be selected, and some specific command message to the controlled element must be formulated and transmitted. A final, and all-important, step is monitoring the results of the control action to ascertain that the desired system state or condition has been achieved. This last step, called feedback, provides an input signal to start the process all over again, thereby creating a loop that permits the control process to be continuous and adaptive.¹⁷

If all of the steps in the general sequence shown in Figure 2 are performed by a human operator, the process is called manual, even though manual action in the strict sense may not be involved. Thus, manual denotes a process that may include visual, auditory, and other forms of sensory perception as well as purely cognitive activities such as interpretation, weighing alternatives, and decision-making. The command output might be accomplished by some manual activity such as pressing a button or moving a control lever, or it might take the form of a voice command or simply a nod of the head. The essential feature of a manual process, as the term is used here, is that all the basic control steps to accomplish a function are human activities.

¹⁷This description overlooks the difference between closed- and open-loop control systems. For a discussion of the application of each in train control technology, see appendix B.

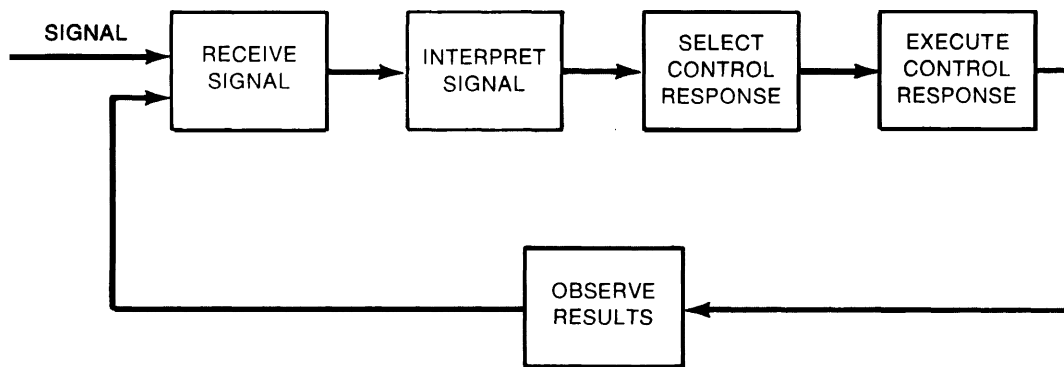

FIGURE 2.—Generalized Control Process

It is also possible for all of the steps in the control loop to be accomplished by some mechanical or electrical device. If so, the process is called automated. The device need not necessarily be complicated, nor is a computer required in order for the apparatus to process information and make a “decision.” A simple junction box with a two-state logic circuit (ON or OFF) would satisfy the definition of an automated control device, provided no human actions were required to receive and interpret input signals, select and order a response, and monitor the result.

Between the extremes of purely manual control and fully automatic control, there are numerous combinations of mixed man-machine control loops. These are called semi-automated or partially automated—the terms are used synonymously to denote a process (or a system) in which there are both manual and automatic elements. Thus, automation is not to be taken in an absolute, all-or-nothing sense. The machine can be introduced by degrees into a system to perform specific functions or parts of functions. When comparing parts of a train control system or when comparing one system with another, it is therefore possible to speak of automation in comparative terms and to say that one is more or less automated than another, depending on how many specific functions are performed by machines.

For brevity, acronyms are used to describe certain areas where automation is applied in train control. ATC (automatic train control) refers generally to the use of machines to accomplish train control

functions. It does not necessarily suggest a completely automated system. It can be applied to a system where certain functions or groups of functions are performed automatically while others are performed manually. ATP (automatic train protection), ATO (automatic train operation), and ATS (automatic train supervision) are used to designate major groups of functions that may be automated. For example, if a system is said to have ATP, it means that train protection is accomplished (either completely or mostly) by automatic devices without direct human involvement. If a system is described as having ATC consisting of ATP and some ATS, this indicates that train protection is assured by automatic devices and that train supervision is a mixture of manual and automatic elements. By implication, train operation in such a system would be manual.

While automation involves the substitution of machine for human control, this does not mean that the human operator is removed from the system altogether. An automated system is not always an unmanned system, even though all functions are routinely performed by machines. For instance, train protection and train operation may be completely automatic in a given transit system, but there could still be an operator or attendant on board the train to oversee equipment operation and, most importantly, to intervene in the event of failure or malfunction. This emergency and backup role is, in fact, a major type of human involvement in even the most automated train control systems. In all rail rapid transit train control systems now in

operation or under development, automation is utilized only for normal modes of operation, with manual backup as the alternative for unusual conditions, breakdowns, and emergencies.

In passing, it should also be noted that automation is not synonymous with remote control, even though the two may at times go hand in hand. In train supervision, for example, many functions are accomplished manually by controllers who are physically far removed from the train and wayside. In central control facilities, the operators may never actually see the vehicles or track and yet perform all or most of the functions necessary to set up routes, dispatch trains, and monitor traffic. Conversely, automated functions are often performed locally, i.e., by devices on board the train or at a station or switch. In general, the location of the controlling element in relation to the controlled element is independent of how the functions are accomplished. However, it is also true that automation does facilitate the process of remote control, and systems with a high level of ATC tend also to employ more centralized forms of train control, especially for supervisory functions.

AUTOMATIC TRAIN CONTROL TECHNOLOGY

The automatic equipment that accomplishes train control functions is often of complex design, but the basic technology is quite simple. The purpose of this section is to provide an acquaintance with the fundamental elements of an ATC system—track circuits, signaling apparatus, train operating devices, interlocking controls, and supervisory equipment. The details of this technology and the design features of ATC equipment now in use in rail rapid transit systems are omitted here but are provided in appendices B and C.

Track Circuits

For safety and efficient operation of a transit system, it is imperative to know the locations of trains at all times. The sensing device providing this information is the track circuit, which was invented over 100 years ago and has remained essentially unchanged in principle even though extensively refined and modified in its engineering details.

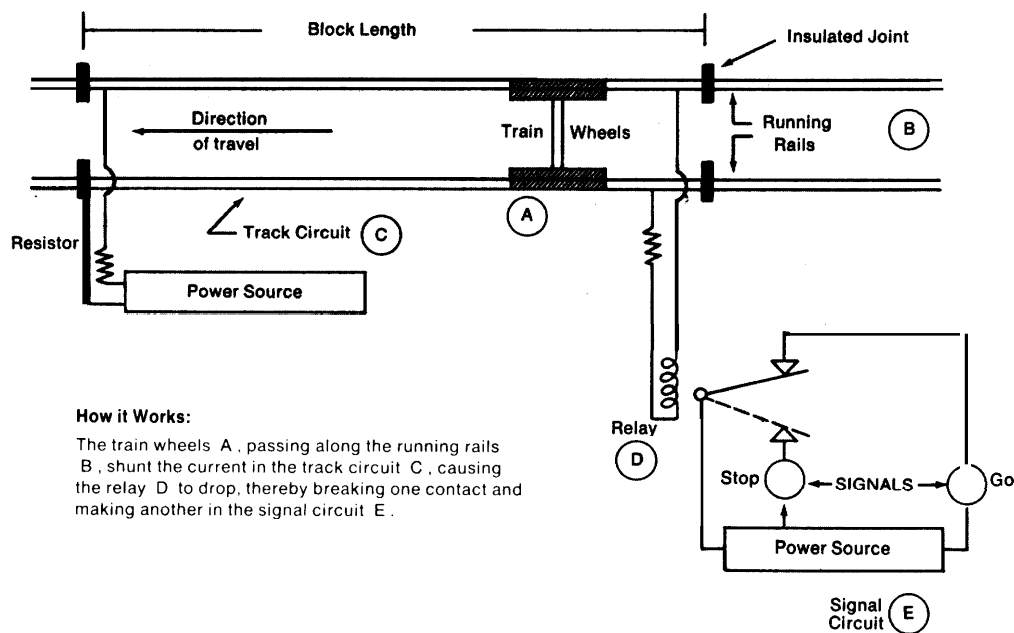

FIGURE 3.—Simple D.C. Track Circuit

The track circuit is an electrical circuit consisting of a power source, the running rails, and a signal receiver (relay).¹⁸ The track is divided into electrically isolated segments (called blocks) by insulated joints placed at intervals in the running rails.¹⁹ This forms a circuit with a power source connected to the rails at one end of the block and a relay at the other. The relay, in turn, forms part of a second electrical circuit which has its own independent power supply (commonly a battery) and includes a signaling device such as wayside colored lights,

When no train occupies the block, the relay is energized by the track circuit battery, causing the relay to “pick up,” i.e., a movable element (armature) is moved to and held electromagnetically in a position opposed to the force of gravity. This closes an electrical contact in the secondary signal circuit. When a train enters the block, the wheels and axles conduct electricity between the running rails, thereby short circuiting (shunting) the track circuit and reducing the current to the relay. This weakens the electromagnetic force holding up the armature, allowing it to drop under the force of gravity. This action opens the contact that was previously closed and closes a different contact in the signal circuit. The relay, therefore, acts as a switch in the secondary signal circuit and creates one electrical path when it picks up and another when it drops.

Thus, the basic principle of the track circuit is the shunting phenomenon produced by the train wheels passing along the electrically energized running rails. The presence of the train is detected in the track circuit as a reduction of electrical current, which—by means of the relay—is used to control the secondary signal circuit and operate various types of track occupancy indicators.

The track circuit is designed according to the fail-safe principle. In order for a clear (unoccupied block) indication to be given, the track circuit must be in proper working order. If one of the rails were

¹⁸Track circuits may utilize one or both running rails, may operate on direct or alternating current, and may have electromechanical relays or solid-state electronic receivers. The type described here is a double-rail dc track circuit with a relay. The other types are similar in principle and operation.

¹⁹Block length in rail rapid transit systems varies considerably as a function of track and traffic conditions and signal system design. Some are as short as 40 feet; others are over half a mile long.

to break, the relay would receive no current; and the armature would drop just as if a train were present. A broken electrical connection, a failure of the power source, or a burned-out relay coil would also have the same effect.

Wayside Signals

One of the earliest types of signal devices employed to control train movement, and one still widely used, is the automatic wayside block signal. It consists of a color-light signal, in appearance much like the traffic signal on city streets, located beside the track at the entrance to each block. This signal is controlled by the track circuit relay, as described above. The signal directs train movement by displaying red, yellow, or green lights (aspects) to indicate track circuit occupancy ahead,

Since it would be impractical for the train to creep ahead block by block, waiting to be sure each block is clear before entering, the wayside signals are arranged to give the operator advanced indication of speed and stopping commands. Figure 4 is an illustration of a three-block, three-aspect wayside signal system. This signaling arrangement tells the train operator the occupancy of the track three blocks ahead of the train and conveys three different movement commands (indications)—green (proceed), yellow (proceed prepared to stop at the next signal), red (stop).

In the illustration, Train A is stopped in Block 4 and Train B is approaching from the rear. Since there is a separation of at least three blocks between them, Train B receives a green aspect at the entrance to Block 1, allowing it to proceed at the maximum allowable speed. At the entrance to Block 2, however, Train B receives a yellow aspect, indicating that the train operator should be prepared to stop at the next signal because there may be a train ahead. At the entrance to Block 3, Train B is commanded to stop by a red signal aspect. When Train A leaves Block 4 and moves on to Blocks 5 and 6, the signal at the entrance to Block 3 changes to yellow and then green, allowing Train B to proceed.

The wayside signaling system is made fail-safe through design and by operating rules. Dual, or sometimes triple, lamps are used to illuminate each signal aspect. Redundant power sources are sometimes provided. The ultimate safeguard, however, is

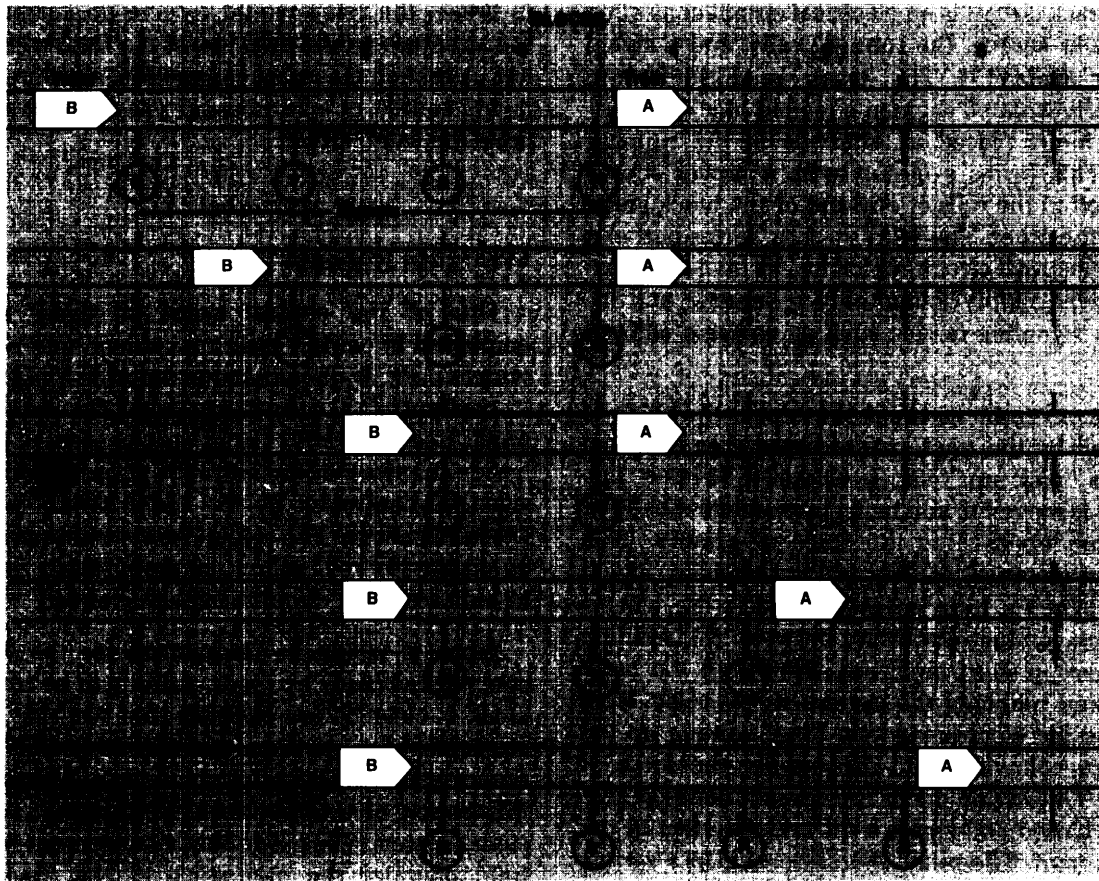

FIGURE 4.—Three-Block, Three-Aspect Wayside Signal System

procedural. A complete failure of the signal lamps or a loss of power would result in a dark (unlighted) signal, which standard operating rules require the train operator to observe as if it were a red signal.

Trip Stops

In the wayside signal system described above, safe train movement depends solely on the compliance of the operator with signal indications. To guard against error, inattention, or incapacitation of the train operator, wayside signals can be supplemented with an automatic stop-enforcing mechanism, called a trip stop.

The trip stop is a device located beside the track at each wayside signal. The type commonly used in the United States consists of a mechanical arm that is raised or lowered in response to the track occupancy detected by the track circuit. When the arm is in the raised position, it engages a triggering device on the train and actuates (trips) the emergency

brake.²⁰ A train entering a block in violation of the wayside signal indication would thus be brought to a complete stop before colliding with the train in the next block regardless of what action the train operator took, or failed to take.

In addition to protecting against rear-end collisions, trip stops can also be used in conjunction with the track circuits and other signal appliances to provide automatic protection against overspeed. For this application, a timing device is added to the circuit controlling the trip stop. When a train enters a

²⁰An alternative system employing inductive train stops is used on main-line railroads in the United States and on rail rapid transit systems abroad. The device is somewhat more complex than the mechanical trip stop, but it avoids mechanical contact between a stationary wayside element and a moving train and is less vulnerable to blockage by snow or debris. Both trip stops and inductive train stops have the inherent disadvantage of requiring strict alinement of wayside devices. Further, if either type of device is removed, the system will operate in a mode that is not fail-safe.

block, the trip stop at the entrance to the next block is in the raised position but will be lowered after a time interval corresponding to the minimum time (the maximum speed) permitted for a train to traverse the block. This arrangement is commonly used on curves, downgrades, and other such sections of track where excessive speed could cause a derailment. A variation of this scheme is commonly used at stations to allow a following train to close in on a leading train, provided the follower moves at appropriately diminishing speed as it approaches its leader.

Like track circuits and signals, the trip stop is designed to operate in a fail-safe manner. The trip is raised to the stopping position by gravity or a heavy spring and lowered by a pneumatic or electric mechanism. Thus, failure of the trip stop actuating mechanism or its source of energy will result in the trip stop being raised to the stop position.

Cab Signals

Automatic block signal systems with wayside signals and trip stops, while offering effective train protection, have certain operational disadvantages. Sometimes the signals are obscured by fog, rain, or snow. In such cases, operating rules require that the operator consider the signal as displaying its most restrictive aspect and operate the train accordingly. If the signal is actually displaying a more permissive indication, time is lost unnecessarily. A second disadvantage is that wayside signals convey commands only at the entrance to a block. The train operator must reduce speed to the maximum permitted by the signal and maintain that speed until reaching the next signal. If conditions change immediately after the train enters the block and it becomes safe to proceed at a greater speed, the train operator has no way of knowing this since the signal is behind him. Again, time is lost. With wayside block signals there is also the possibility that the operator will fail to observe the signal correctly, read the wrong signal in multiple-track territory, or forget the indication of the last signal passed. If there are trip stops, these kinds of human failure do not result in an unsafe condition, but the efficiency of train operation can be adversely affected.

One way to overcome these disadvantages is to provide signal displays within the cab of the train. This is called cab signaling. A display unit, mounted in the cab within the train operator's forward field

of view, shows indicator lights similar to those of wayside signals, e.g., red, yellow, and green aspects. Cab signals can thus convey the same movement commands as wayside signals, but they do so continuously in response to the instantaneous condition of the track ahead. They can also convey precise speed commands instead of just stop-and-go information, thus providing more flexible operation and paving the way to ATO. The cab signal unit has an audible warning that sounds whenever the signal aspect becomes more restrictive and continues to sound until the operator silences it by an acknowledging device. Figure 5 is an illustration of a typical cab signal.

Transferring the display of information from the wayside to the cab involves an alternate type of track circuit technology. To operate cab signals, the current passing through the track circuit (usually a.c. is not steady, as for conventional wayside signals, but is pulsed (turned on and off) at several different repetition rates in response to track occupancy. Each pulse rate is a code to indicate allowable train speed. This pulsed d.c. energy is passed through the rails, picked up inductively by a receiver (antenna) on the train, and decoded to retrieve speed command information. This information is used to actuate the appropriate cab signal display. Because the train is continuously receiving pulses of energy, a change in the pulse rate of the coded track circuits indicating a change of conditions ahead of the train is instantaneously received by carborne equipment and displayed by cab signals regardless of where the train happens to be within a block.

Figure 6 illustrates how cab signals control a train in a three-block, three-aspect signaling system. In this example, the code rates transmitted through the rails (expressed as pulses per minute) correspond to the following signal aspects:

180 Green (Proceed)

75 Yellow (Proceed at medium speed prepared to stop)

0 Red (stop)²¹

²¹Note that 0 code—the absence of a code—is the most restrictive. Thus, any failure of the track circuit or the carborne receiver is a fail-safe condition since it is interpreted by the cab signal equipment as a command to stop.

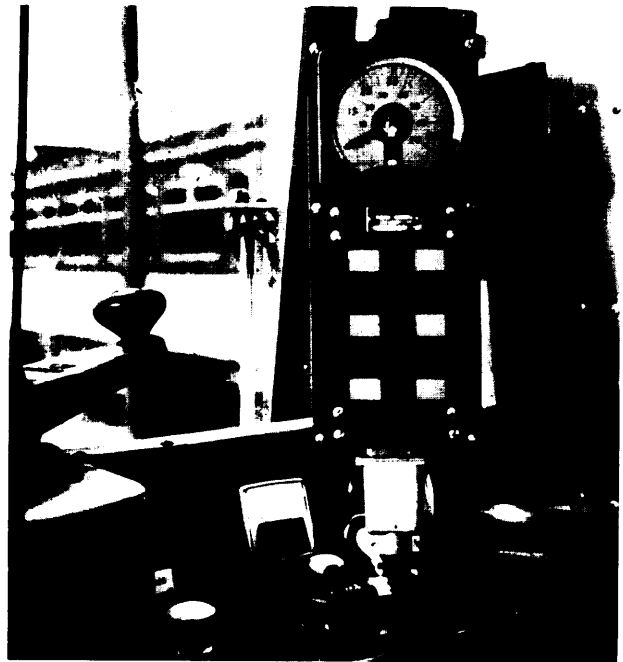
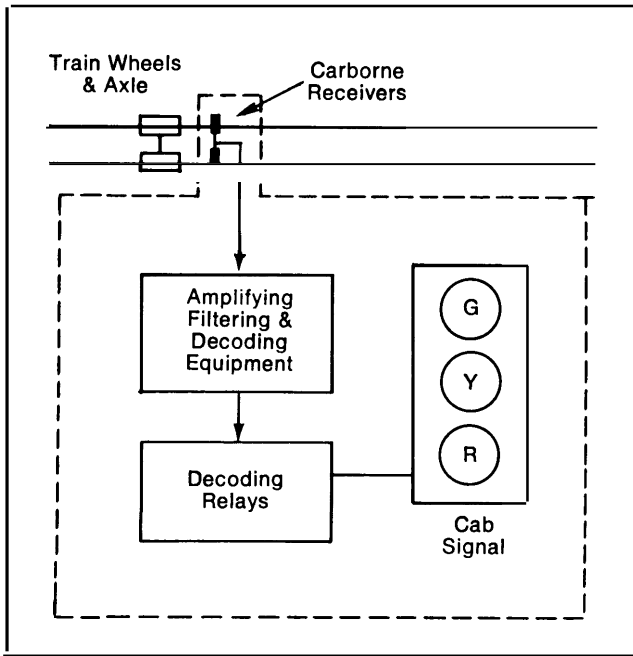

HOW IT WORKS: Receiver coils, mounted on the train near the rails, receive pulse-coded track signals, which are decoded and used to pick up relays that energize the cab signal lamp indicating track conditions ahead.

FIGURE 5.-Cab Signals

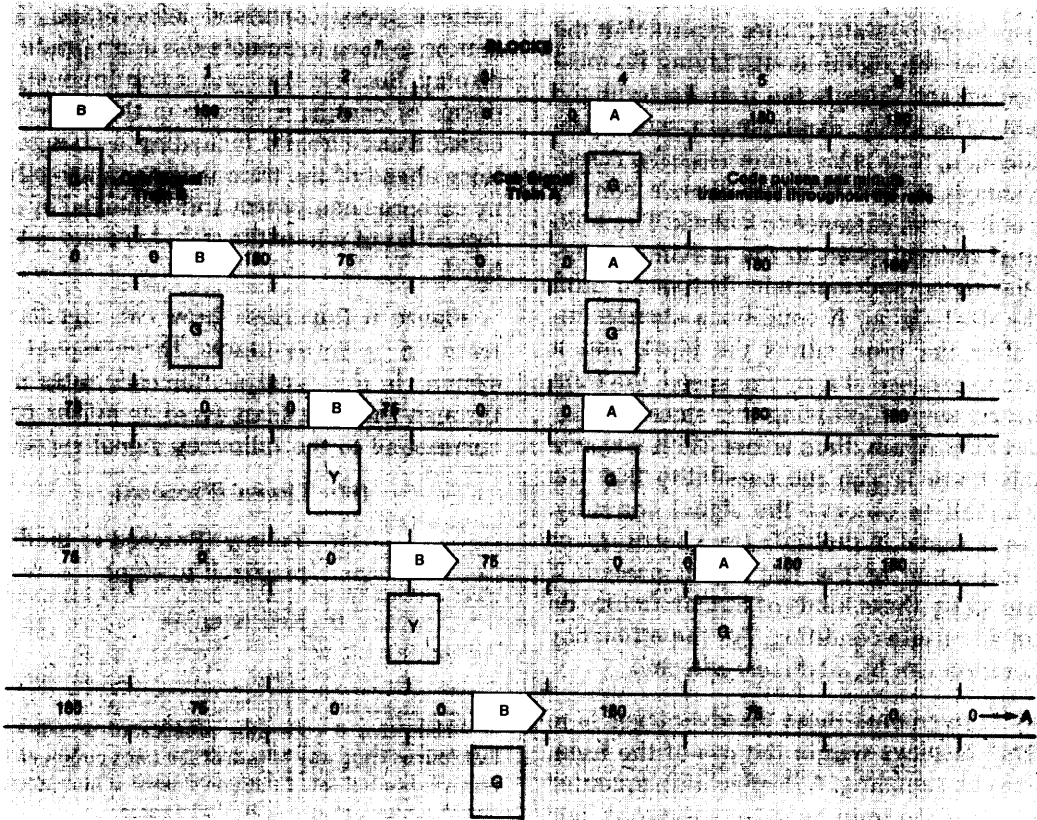

FIGURE 6.—Three-Block, Three-Aspect Cab Signal System

The situation depicted here is the same as in the illustration of wayside signals (figure 4). Train B is approaching Train A, which is completely stopped. Note that the moment Train A starts to move and clears the block, Train B receives a green signal immediately—not at the entrance to the next block, as it would with wayside signals. Note also that a O code appears in the part of the block immediately behind Train B as it moves along the track and that Train B can approach closer to Train A before being required to stop,

Speed Control

With the addition of speed sensing and brake control mechanisms, cab signals can also be used to provide automatic overspeed protection. Figure 7 is a schematic diagram of such a system. It is the same as the schematic shown in figure 5, except for the addition of speed and code rate comparison equipment and the direct connections to the propulsion and braking systems.

This arrangement allows the train operator to control speed so long as it does not exceed the commanded speed shown on the cab signal unit. If the commanded speed is exceeded or if the block speed changes to a lower value because of another train ahead, the operator receives an audible warning. The operator has a fixed time (typically 2 to 3 seconds) to initiate the required braking manually. If this is done, the brakes can be released when the commanded lower speed is reached. If not, the brakes are applied automatically and irrevocably by the ATC system, and the train is brought to a full stop before the operator can resume control. This is analogous to the overspeed control provided by wayside signals with trip stops, except that braking can be initiated anywhere within a block not just at the entrance. Another difference is that trip stops act to stop the train after an overspeed condition has occurred over a measured course, usually several hundred feet in length. Cab signals do the same, but instantaneously, thus eliminating the delay inherent in the preliminary measured course and per-

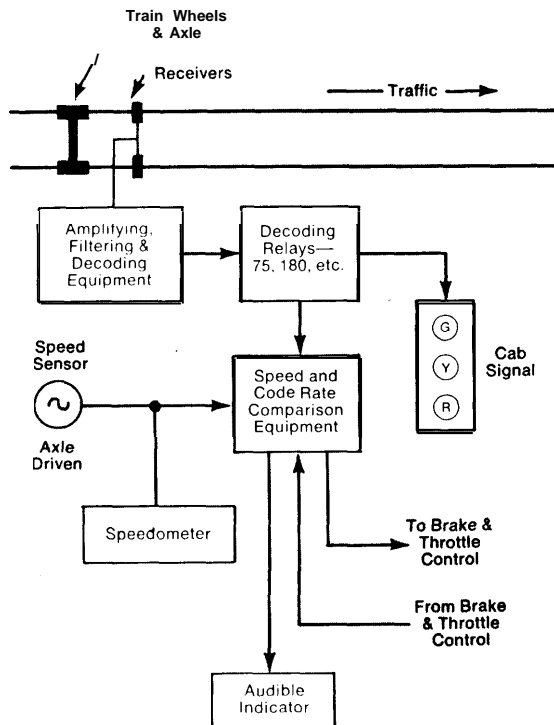

FIGURE 7.—Cab Signal System With Automatic Overspeed Protection

mit trains to follow one another more closely for a given block length.

Automatic Train Operation

Basically cab signaling provides carborne automatic train protection in the form of collision prevention. With the addition of on-board equipment for sensing and comparing command (allowable) and actual speed, cab signaling makes it possible to expand the train protection function to permit speed regulation. This, in turn, forms the basis for extending automation into the area of train operation.

Several forms of automatic train operation (ATO) are possible, but all have two basic features-automatic speed regulation and station stopping.

Automatic speed regulation (ASR), as the name implies, is basically a comparator circuit for matching actual speed to command speed. Speed commands received from coded track circuits are picked up by a carborne receiver, decoded, and compared to actual train speed sensed by a tachometer in the drive mechanism. Up to this point, an automatic speed regulation system is like cab signaling. The difference arises in how this comparison is used. With cab signals, the comparison is used to actuate a penalty brake application to stop the train when actual speed exceeds command speed. With ASR, the comparison is used to control the motors and brakes in an effort to minimize the difference between actual and command speed. An advisory display of speed commands and train speed may be provided for the operator. In effect, ASR removes the human operator from the control loop for running the train and provides for an essentially instantaneous and invariant response by propulsion and braking systems, without the delay of human reaction time and without the variability and possibility for misinterpretation inherent in manual train operation.

The other basic element of ATO is station stopping, which involves bringing the train to stop automatically at a predetermined location in each station. This is accomplished by special wayside control units working in cooperation with position receivers, logic circuits, and automatic speed regulation equipment on the train. One method uses wayside "triggers" spaced some distance from the station as reference points for programmed stopping. The first trigger, farthest from the station,

transmits a command signal that generates, on board the train, a velocity-distance profile which the train is to follow to a stop. Additional triggers, nearer the station platform, correct the generated velocity-distance profile for the effects of wheel slip and slide. The ASR system monitors the velocity-distance profile and controls the braking effort to bring the train to a stop at a predetermined point. Another method of programmed stopping makes use of long wayside antenna to provide a series of position signals to a carborne control system as the train passes along its length. The carborne control system determines train position and combines this with speed and deceleration information (sensed on board the train), to produce an appropriate propulsion or braking command for the traction control system.

To this basic ATO system, other automated features may be added. Doors can be opened automatically after the train is brought to a stop in a station. This requires a circuit to actuate door opening mechanisms and appropriate safety interlocks to assure that the train is in fact stopped and at a station. Door closure may also be automated by adding a timing circuit to measure how long the doors have been open and to initiate a door closure signal automatically after a predetermined dwell time has elapsed. Train departure can also be initiated automatically by introducing another control circuit to apply propulsion power after receipt of a signal confirming that doors are closed and locked.

For each of these levels of ATO, the train operator may be provided with an advisory display to show what commands are being received and what response is being made by automatic mechanisms. The operator may also be provided with manual override controls to inhibit automatic functions or to vary automatic system operation. For example, the operator may intervene manually to adjust the stopping point, to prevent some or all doors from opening, to vary station dwell time, or to initiate or prevent departure. Figure 8 shows a functional diagram of a typical ATO system and a picture of the train operator's console.

Interlocking

An interlocking is an arrangement of signals and signal appliances so interconnected that functions must succeed each other in a predetermined sequence, thus permitting safe train movements along a selected route without collision or derailment. An

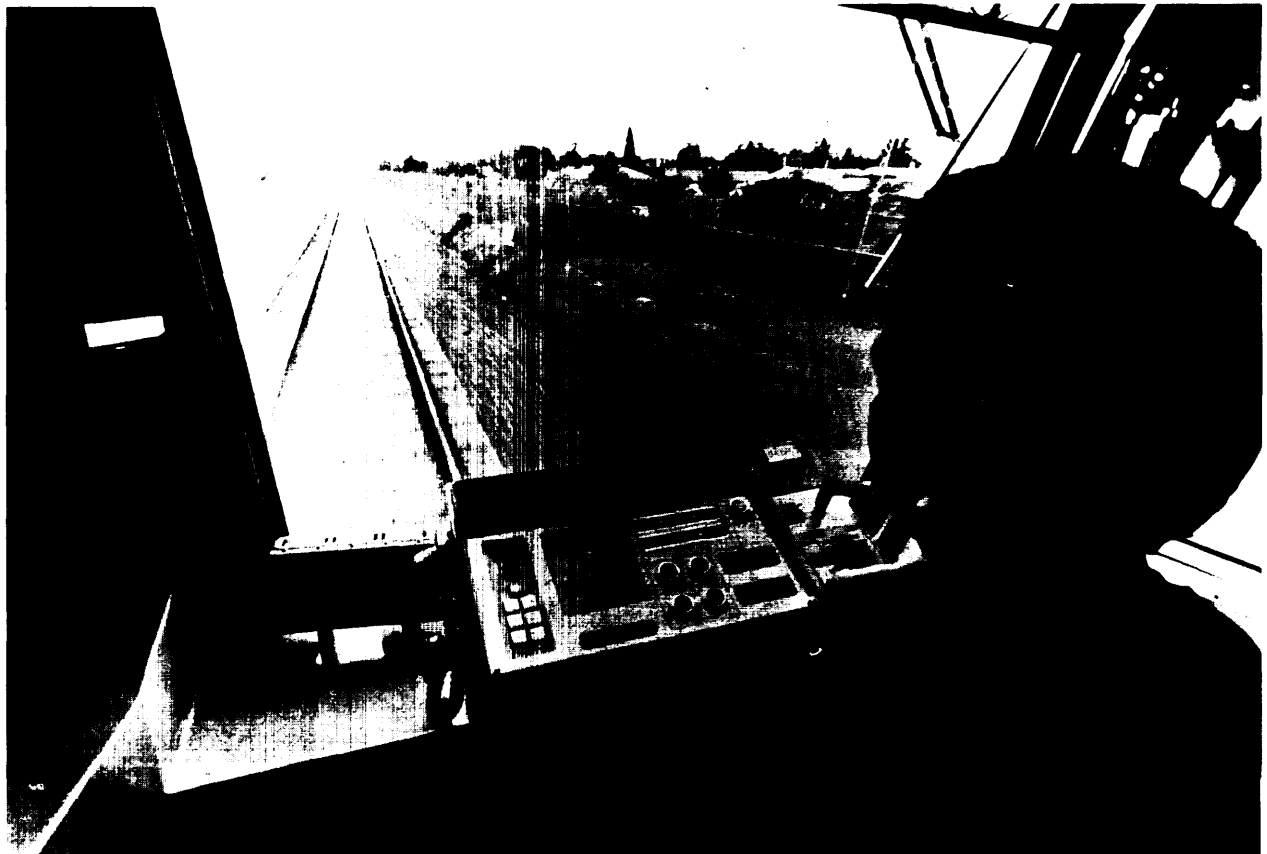
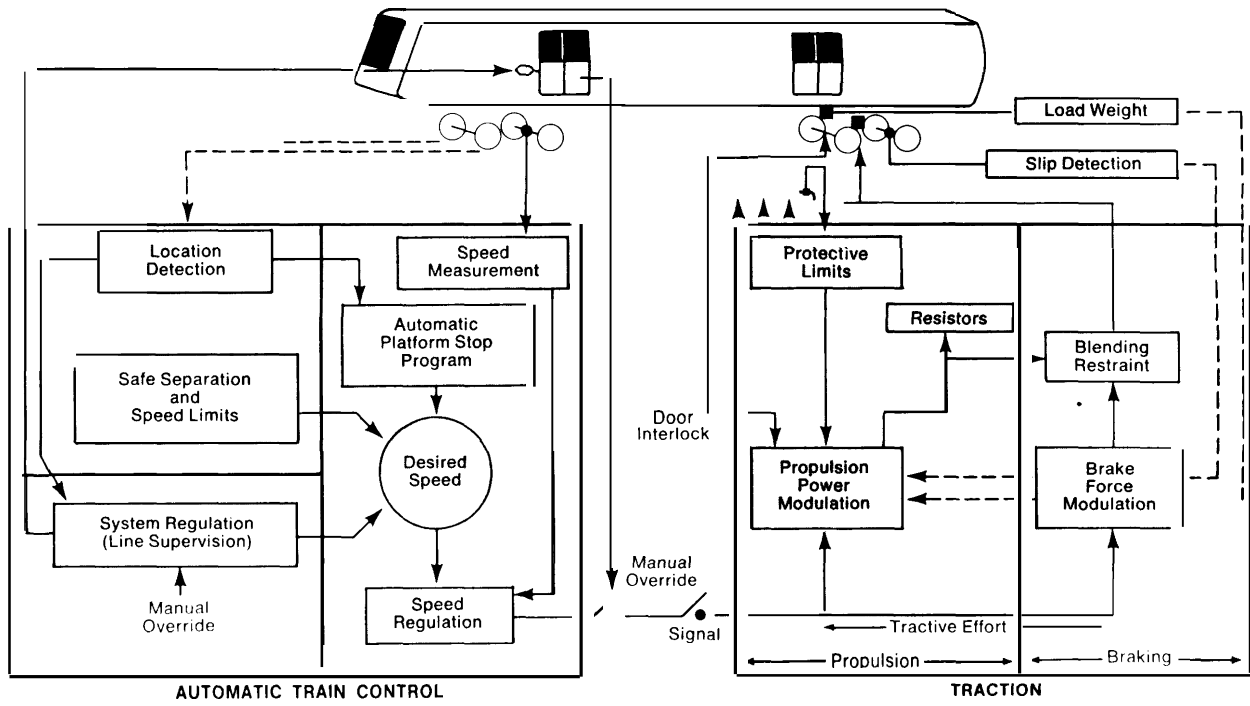

FIGURE 8.—Automatic Train Operation System



FIGURE 9.—Typical Interlocking Location

interlocking thus consists of more than just switches to allow trains to move along crossing, merging or branching routes; it is also made up of signals and control devices that automatically prevent conflicting or improper movements. Interlocking may be manually controlled or equipped with automatic devices that sort trains through branches and junctions according to desired destinations,

Several forms of automatic interlocking are in use. One of the oldest and simplest is an arrangement of hand-operated switches, each of which controls an individual signal or track turnout. The switches are mechanically or electrically interconnected such that once a particular route is selected, the switch points locked in place, and the signals cleared, no other route for a potentially conflicting move can be established until the train bound for the cleared route has safely passed. This arrangement represents a semiautomated form of movement control. Manual operation is required to select a route and move the control levers, but all else

follows automatically, including inhibition of further switch movement until the train has traversed the limits of the interlocking.

A more advanced, but still not completely automated, type of interlocking is a system that permits a towerman or central supervisor to select the entrance and exit points for a train to pass through an interlocking, with the switches and signals for the appropriate route then being set up automatically by an arrangement of electrical relays. Figure 10 shows such a control panel for a system called entrance-exit route interlocking. The tower operator moves the control knobs to designate a desired route. Internal logic circuits automatically select the best available nonconflicting route, align and lock switches, and activate the appropriate wayside signals to allowing train movement while holding other signals at stop to prevent conflicting moves. This level of automation may be characterized as automatic execution in response to manual inputs,

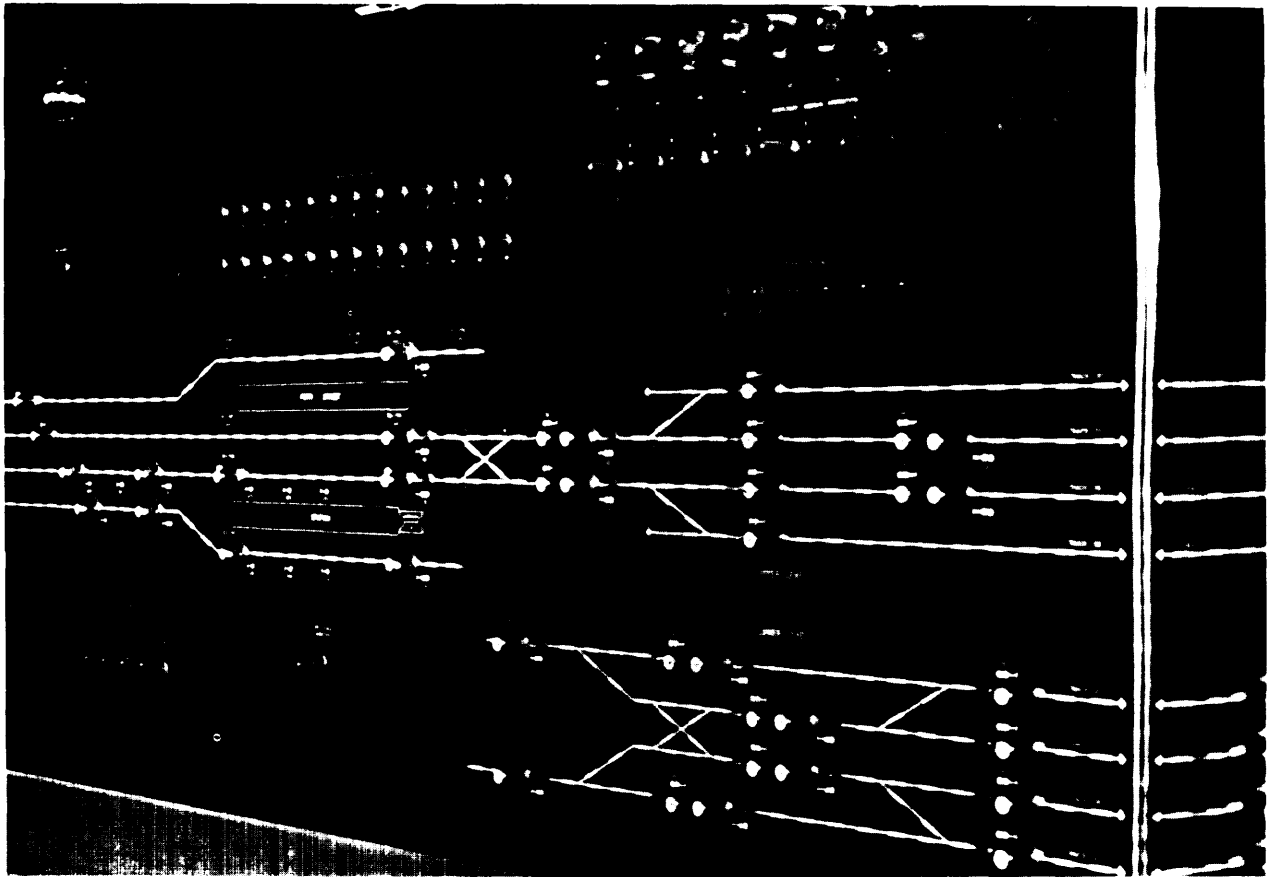

FIGURE 10.—Entrance-Exit Interlocking Control Panel

Fully automatic interlocking are also in use. In addition to track circuits, switch operation, and signal control elements, the automatic interlocking must have some device for identifying a specific train in order to create the necessary input to the logic circuits.²² One method to identify trains is by means of wayside optical device that scans a panel on the lead car which gives destination, route, and other needed information. Another method makes use of a carborne transponder that is interrogated by a wayside device. With either technique, however, train identity becomes the substitute for manual inputs that allows trains to be sent along predetermined routes without human involvement.

²²A rudimentary form of automatic interlocking is one that uses a simple in-out logic circuit to switch trains from one track to another. This device is commonly used at terminals and operates to switch each entering train from the inbound to the outbound track and thus does not require train identity information.

Train Supervision Equipment

Train supervision embraces a wide variety of functions. The special-purpose equipment that has been developed to perform these functions is equally varied. In a general survey of train control technology it is not possible to describe all types of automatic and semiautomatic devices that are in use. The following, therefore, is a brief catalog of some of the more important systems.

Train dispatching is concerned with the timing of train departures from terminals in accordance with the schedule of operations. In conventional transit systems this function is accomplished by preprogrammed dispatching machines that automatically ring a bell or flash a light as a signal to the train operator that it is time to leave a terminal or intermediate waypoint. In some systems, the dispatch function may be assigned to a central train control computer that transmits electric start-

ing signals to the train in accordance with a master schedule stored in the computer memory.

Route assignment and control is a train supervisory function that is allied to the train protection function of route interlocking. Route control is a strategic function, consisting of selecting routes for trains and transmitting the orders to wayside points, where the orders are implemented tactically by interlocking equipment. In conventional transit systems, route assignment and control is performed locally, either manually or automatically. With remotely controlled route interlocking, however, it becomes operationally practical to place the strategic and tactical management of routing in a computer. The programming to accomplish this is relatively simple and straightforward, and a computer is ideally suited to handle what is an essentially repetitious task with a limited number of alternative courses of action. The safety aspects of route interlocking are assured not by central computer control, but locally by conventional interlocking equipment at the wayside,

Performance monitoring involves comparing the overall movement of traffic with the schedule and

taking action to smooth out irregularities of traffic flow. In most transit systems this function is carried out by central control personnel aided by automatic display devices. One such device is a pen recorder that marks a moving paper graph to record the passage of trains past check points. Each spike on the graph indicates the presence of a train, as detected by the track circuits, at some time and place along the route. A train supervisor, by checking this graph against the schedule, can monitor the progress of all trains operating on line and detect delays or queuing up of trains, (Figure 18, page 36 shows such a device,)

Another form of performance monitoring aid is the model board (figure 11), which is a schematic representation of the track plan of the transit system with indicator lights to denote track circuit occupancy and, hence, the position of each train on the line. This is the functional equivalent of the pengraph recorder, but in a more pictorial form of display. Another type of model board used in newer transit systems has, in addition to the master track plan, small cathode ray tube displays that permit individual supervisors to obtain more detailed or expanded views of selected track sections or to call up special-purpose presentations of data,

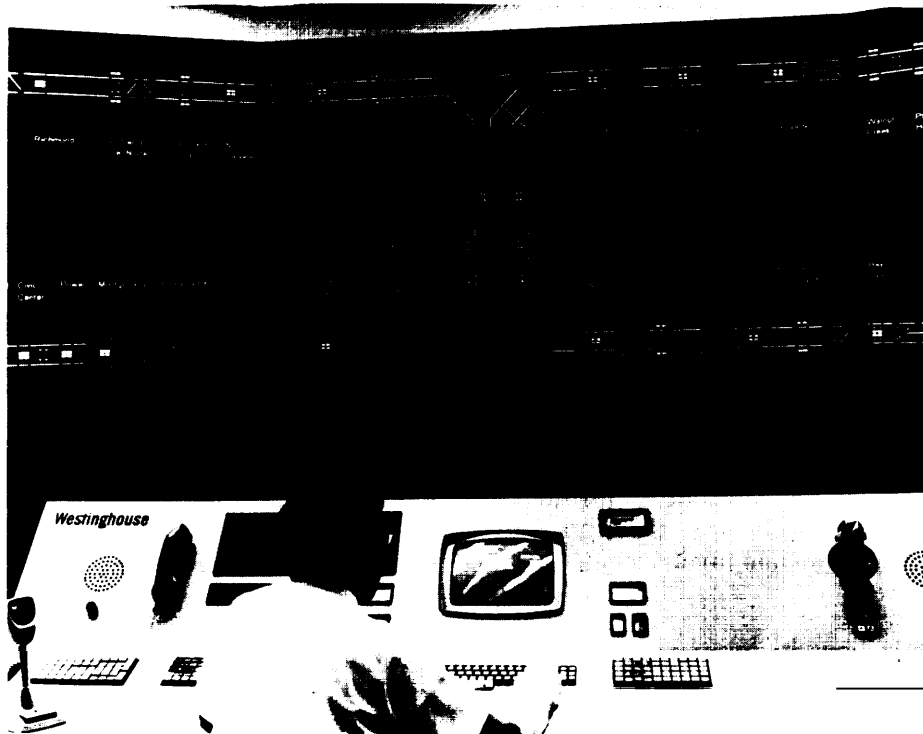

FIGURE 11.—Model Board and Train Control Console

Pengraphs, model boards, and the like are not fully automatic supervisory devices. The human operator is still needed to interpret the display and to formulate orders to individual trains. In the most advanced systems routine performance monitoring is assigned to computers, which keep a continuous watch on traffic movement and automatically calculate and transmit performance commands to trains. Man, in this circumstance, acts in a completely different supervisory capacity. He does not monitor and regulate traffic. Instead, he supervises machines which, in turn, monitor and regulate traffic.

There are two general types of action that can be taken to smooth out irregularities in traffic flow. Both are accomplished in response to commands from central control. One is to hold a train in a station for a time longer or shorter than the scheduled dwell time or, in extreme cases, to direct a train to bypass a station in order to close up a gap. The other method is to alter the speed of the train between stations. This latter method is called performance level modification and takes the form of a proportional reduction of train speed below the speed normally allowed in each block. In systems supervised by a central computer and with automatic train operation, performance level modification is accomplished without human intervention. The required reduction is calculated by the central computer and automatically transmitted to stations or other critical locations, where the signals are picked up by carborne ATO equipment that modifies the response to the normal speed commands transmitted by the coded track circuits. These systems may

also include provisions for manual inputs and displays at central control or on the train, but the normal mode of operation is automatic.

A WALK THROUGH A TRANSIT SYSTEM

To place ATC in perspective, it maybe helpful to make a brief tour of the facilities of a transit system, pointing out the type and location of the equipment that carries out train control functions.

Station

The passenger's first point of contact with a transit system is the station. The most prominent features—vending and fare collection facilities (possibly automated), escalators and elevators, heating and air conditioning, and platform amenities—have nothing to do with train control. There may also be public address systems and video or audio surveillance equipment for fare collection and platforms. These are not, strictly speaking, part of the train control facility even though they maybe connected to the central control facility and monitored by central supervisory personnel. About the only direct manifestations of ATC are the automated train departure and destination signs or loudspeakers found in some transit systems. These public announcement devices are connected to the ATC system and use information inputs derived from track circuits and train identification equipment. There may be an ATC equipment room in the station, but it is out of sight and locked. Its presence is usually unknown to passengers.



FIGURE 12.—General View of Rail Rapid Transit Station

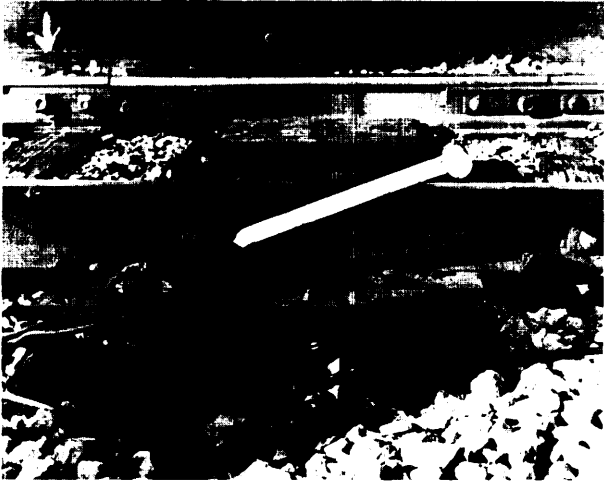
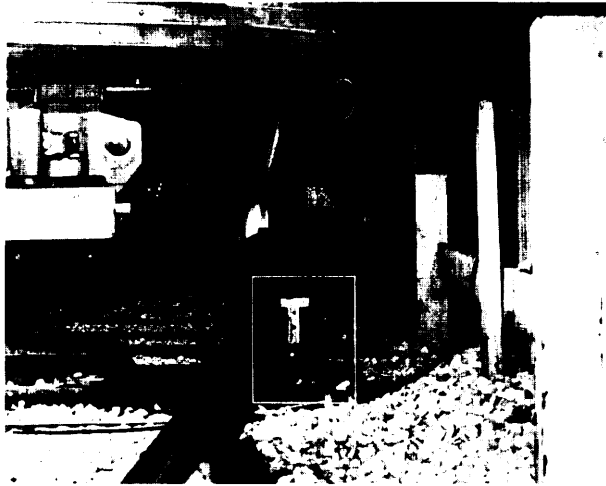

FIGURE 13.—Trip Stop

Wayside

An observant passenger might notice two wayside features that can be seen from the station platform. Looking down the tracks in the direction of train movement, there are wayside signal lights that change aspect from time to time. Often, just beyond the downstream end of the platform and alongside the rail, there is a trip stop which can be seen to raise behind a train that has just left the station and later lower as the train recedes.

Moving out along the tracks, other wayside elements can be found. The track circuits themselves are not plainly visible since they are largely in wayside housings. However, at intervals there are small flat equipment cases situated between the rails and connected to them by electrical wiring.

These are the impedance bonds that isolate the track into blocks. At the ends of the blocks, there are small boxes, containing relays, with electrical connections from the track circuits to the signaling apparatus,

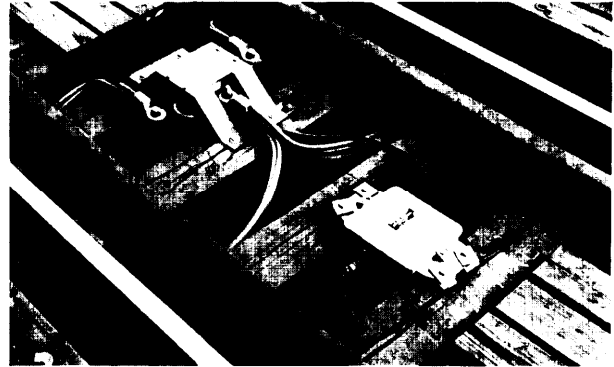

FIGURE 14.—Track Circuit Wiring

Other signal equipment is contained in small cases placed at intervals along the right-of-way. There are also telephones or other communication equipment and antennas or transmitters used for precision station stopping, train identification, or performance level modification. In certain locations, ATC apparatus and other trackside equipment may be housed in small sheds to protect the equipment from the weather and to facilitate maintenance by wayside workers.

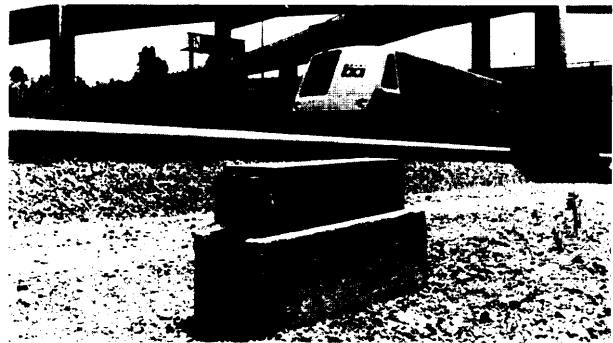

FIGURE 15.—Wayside Equipment Case (contains multiplex equipment for transmitting information between trains and station control rooms)

At junctions and crossovers there is switch apparatus, the most visible parts of which are the switch points, frogs, levers, and motive equipment. This is the wayside equipment, known as a switch machine, that performs the function of interlocking for train protection,



FIGURE 16.—Track Apparatus at an Interlocking

By far the largest part of the equipment, facilities, and structures along the right-of-way—trackage, tunnels, bridges, the third rail, and power distribution equipment—are not related to train control. Nevertheless, the wayside is where the bulk of the ATC equipment in a transit system is located. The proportion varies as a function of the level of automation, but generally about 80 percent or more of all train control equipment is not on the

train but along the wayside and in central control facilities.

Central Control

Supervisory control of the system may be exercised in a central control room equipped with model boards, communication, equipment, system monitoring apparatus, and individual supervisor's

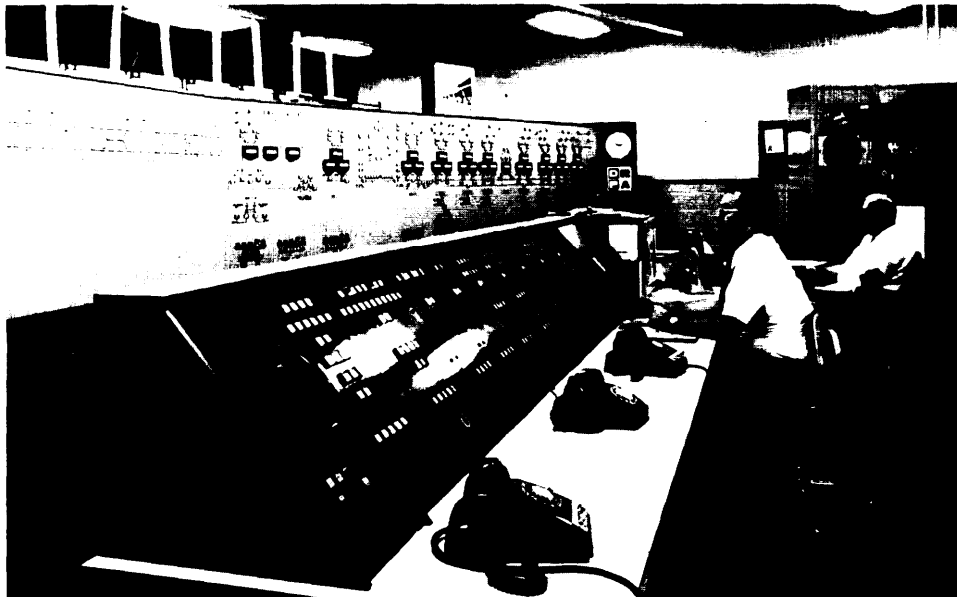

FIGURE 17.—Central Train Control Facility

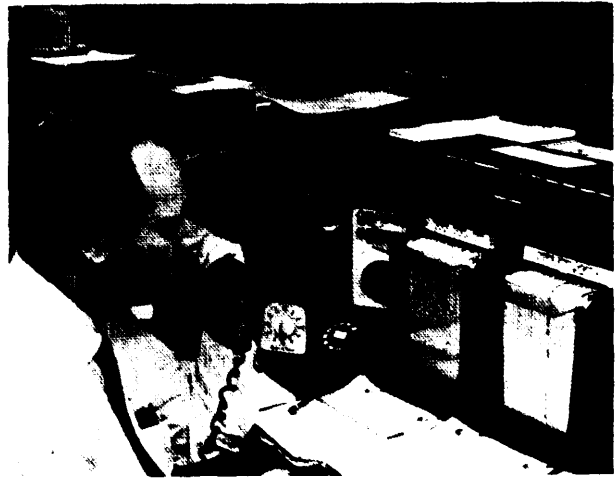
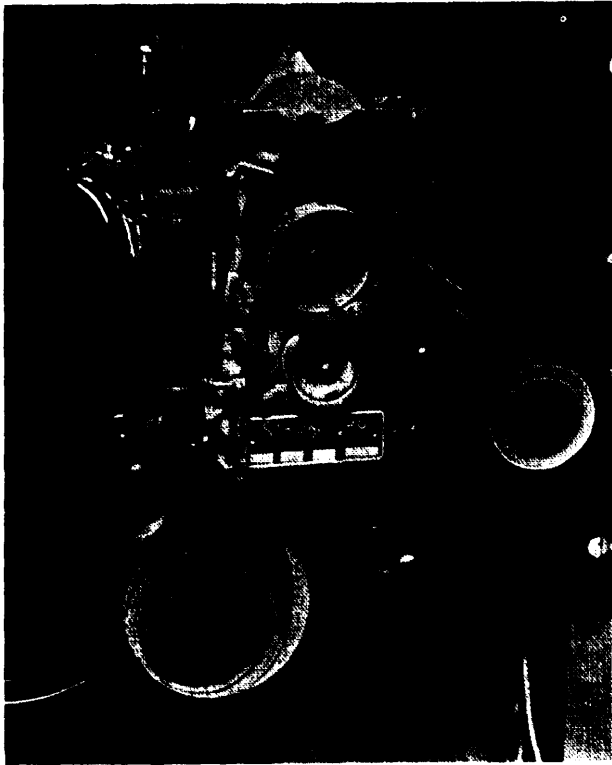

FIGURE 18.—Two Views of a Central Control Facility with Electromechanical Equipment

left—a clock-driven paper tape device for dispatching trains

above—pengraph device for monitoring train movement

consoles. If the system has ATS, the computers and other data processing equipment are also located in the central control building, which often houses administrative and training facilities as well.

Not all transit systems have a single centralized control facility. Some disperse control and supervision to outlying towers, situated at major interlocking along the routes. Figure 19 is a photograph of such a local control tower.

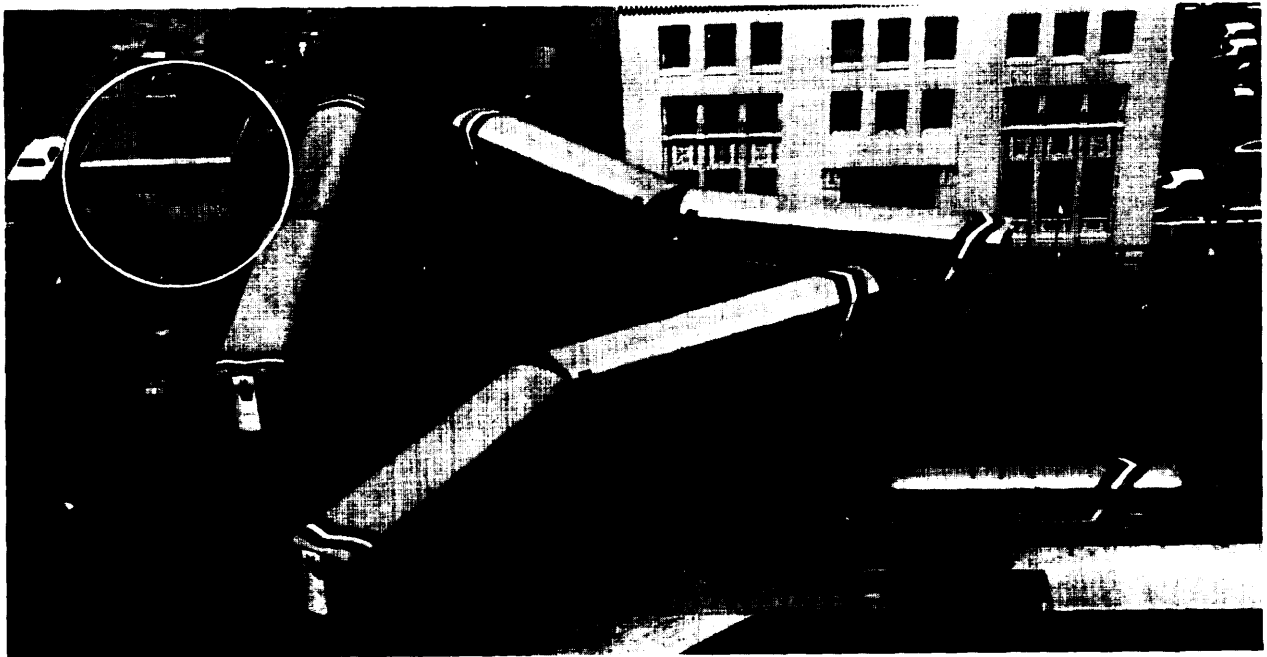

FIGURE 19.—Tower for Local Control of Interlocking

Vehicles

Most of the ATC equipment on transit vehicles is carried in equipment cases under the body or in the train operator's cab. About the only features distinguishable from outside the train are a receiver coil mounted on the lead car to pick up coded track circuit signals (figure 20) and—for systems with optical scanners—small identification panels mounted on the side of each car.

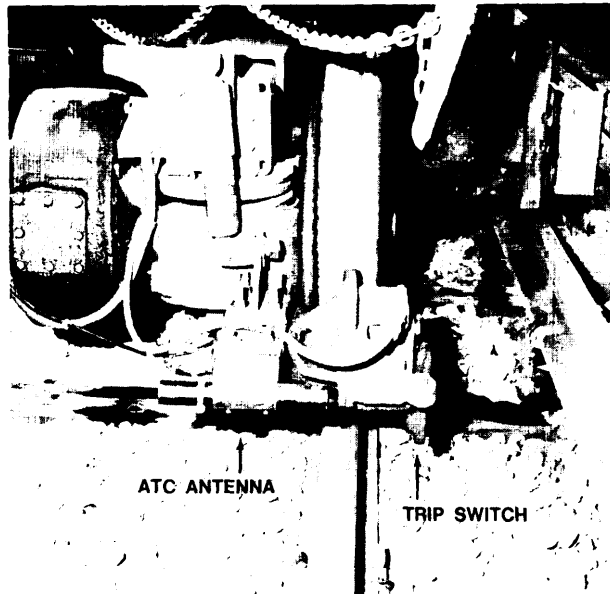

FIGURE 20.—Carborne Receiver Coil for Coded Track Circuit Signals

The operator's cab contains the displays and controls necessary to operate the train or to monitor the functions of ATC equipment. The amount and sophistication of this equipment varies greatly—ranging from very simple and utilitarian apparatus in manually operated systems to highly complex consoles in the newest and most automated systems. The console typically includes propulsion and brake controls, a speedometer and command speed indicator, lighted placards indicating the operating state of automatic elements, warning lights, pushbuttons or control knobs to make data inputs or to select various operating modes, a train phone or radio for communicating with central supervisors, a passenger address microphone, and a deadman control to prevent the train from operating in case the operator is inattentive or incapacitated.

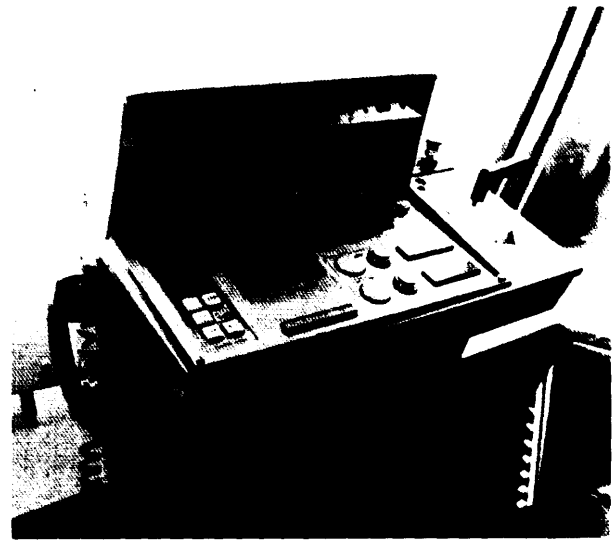

FIGURE 21.—Train Operator's Console for System with ATO

Yards and Shops

A large part of the important activity of a transit system does not occur in revenue service on the main lines, but in the yards and shops. These facilities, though seldom seen by the riding public, contribute greatly to the quality and level of service that the transit system offers.

The yards are usually located near terminals and consist of a vast complex of tracks for storing vehicles and making up trains to be operated on the lines. Even in systems with the most advanced levels of automation, train operation in yards is under manual control. Train sorting and classification is also an essentially manual operation, although some systems have a limited amount of automatic switching in the yards, principally to and from revenue tracks.

Car shops and maintenance facilities are usually located within the yard complex. The shops contain facilities for light and heavy maintenance, component repair, car washing, and checkout of vehicles before they are dispatched back into service.

The maintenance facility may also include a test track and special test equipment to qualify vehicles and components for acceptance or to carry out trials of equipment modifications.



FIGURE 22.—Aerial View of Rail Rapid Transit Yard and Maintenance Facility



FIGURE 23.—Rail Rapid Transit Car Maintenance Shop

LEVELS OF AUTOMATION

It was suggested earlier that train control automation can be viewed as a continuum. At one extreme, all functions are performed by human operators; at the other, all are performed by machines. The transit systems now in operation or under development in this country lie at various points between these extremes, with their relative positions corresponding roughly to the age of the system. The older systems generally have the

lowest levels of automation—primarily ATP with some ATS. The newer systems have ATP and ATO and more extensive ATS, None are completely automated.

Historically, the conversion from manual to automatic train control in rail rapid transit has been incremental and has followed a more or less common course for all systems. These major technological stops along the road to automation are outlined briefly below and summarized in table 1.

TABLE I.—Levels of Automation

LEVEL	CHARACTERISTICS	EXAMPLE
Essentially Manual	Train protection by rules and procedures Train operation manual (with or without the aid of advisory wayside signals) Train supervision by towermen and/or central dispatched	CTA (Ravenswood and Evanston Lines)
Wayside Signal Protection	Wayside block signals with trip stops for train separation and overspeed protection Train operation manual Supervision manual with some automation of dispatching and route interlocking	NYCTA
Carborne Train Protection	Cab signals and equipment-enforced train protection Train operation manual Supervision as above	CTA
Automatic Train Operation	Automatic Train Protection as above Train operation either completely automatic or with manual door operation and train starting Train supervision as above	PATCO
Automatic Train Supervision	ATP and ATO as above Train supervision automatic (or mostly so) under central computer control	BART
Unmanned Operation	ATP, ATO, ATS as above No on-board operator System manned only by small number of central control personnel	AIRTRANS
Full Automation	ATP, ATO, ATS as above, with automatic, not manual backups for each Skeleton force at central control Yard operation automated	None

Essentially Manual

At this level, train protection, operation, and supervision are carried out by train operators and towermen or central supervisors with little or no aid from automatic equipment. Trains are protected and operated either by rules and procedures alone or with the aid of advisory wayside signals. There are no automatic stop-enforcing mechanisms either on the wayside or on board the train. Train dispatching is carried out by personnel at terminals or at control towers along the routes, using either a written schedule or timing devices that act as prompts to signal train departure. Route assignment and interlocking control are accomplished by manually activated equipment that may have some automatic safety features but are entirely controlled by human operators. Communications are by means of visual signals (lights, hand signals, posted civil speeds, etc.) or by telephone from stations and towers to central control.

Many of the older transit systems in this country began operation at the manual level, but they have since advanced to more automated forms of train control. One of the last vestiges of a purely manual system is on the Ravenswood and Evanston lines of the Chicago Transit Authority, which as late as 1975 operated without any automatic block signal protection,

Wayside Train Protection

Wayside signals with trip stops form the basis for automatic train protection, by assuring separation of following trains and preventing conflicting moves at interlocking. Incorporation of timing devices with the trip stops also provides equipment-enforced overspeed prevention. While train protection thus becomes automatic, train operation is still completely manual. Train supervision also remains an essentially manual activity, although track circuits and signals used primarily for train protection do permit some automation of route interlocking and dispatching—usually in the form of semi-automatic devices (i. e., manually activated but automatically operating).

All transit systems in the United States have at least this level of automation. The most notable example of an entire system with enforced wayside signaling is the New York City Transit Authority. Portions of the Chicago, Boston, and Cleveland

systems and all of the Philadelphia (SEPTA) system also employ this form of automatic train protection.

Carborne Train Protection

Cab signaling, using coded track circuits and automatic carborne stopping and speed limit enforcement, represents the same level of ATP as wayside signals with trip stops. To this extent, this level of automation is equivalent to the preceding. Generally, however, cab signaling is considered a higher level of automation since it also provides some automatic aids to train operation—principally automatic and continuous display of speed information to assist the operator in running the train and stopping at stations. Other aspects of train operation are still essentially manual. Cab signaling does not necessarily lead to any increase in the automation of supervisory function nor is it accompanied by any change in the communications systems.

This level and form of automation is generally regarded as the minimum for a new transit system, and most of the older transit systems either have converted or plan to convert to cab-signaled ATP.

Automatic Train Operation

The major advantage of cab signaling over wayside signaling is that bringing the speed command on board the train also permits evolution to automatic train operation. All of the information needed to operate the train automatically is either inherent in the cab signal system or readily available through modular additions. At this level, the human is removed from the speed control, station stopping, door control, or starting loops--or any combination of them. The human no longer functions as an operator but as an overseer of carborne control systems.

Along with ATO, there is often (but not necessarily) an increase in the level of automation of train supervisory functions. ATS functions that are sometimes considered operationally desirable to implement at the time ATO is installed include automatic dispatching, route assignment, and performance level modification.

The two newest transit systems in this country—Bay Area Rapid Transit and the Port Authority Transit Corporation—both have ATO. The new systems under development in Washington, Atlanta, and Baltimore will also have it.

Automatic Train Supervision

Train supervision functions (except for dispatching and route control) are among the last to be automated. To be effective and operationally practical, ATS usually can be introduced only when there is a high level of automation in the areas of ATP and ATO.²³ Automatic train supervision also requires a rather complex and sophisticated communication network, not only for voice messages but also for the interchange of large quantities of data among automatic system elements on a real-time basis. The distinguishing feature of ATS, however, is the use of a central computer (or computers) to process and handle data, make decisions, and formulate instructions.

The Bay Area Rapid Transit system was the first rail rapid transit system to make extensive use of ATS. The new Washington, Atlanta, and Baltimore systems will also have highly automated train supervision based on computer control. While there are some differences among them in the type and amount of control vested in ATS computers, these four stand apart from all other transit systems in this country in the extent to which automation technology is applied to train supervision.

Unmanned Operation

At all the levels of automation described previously, there is at least one operator on board each train and some supervisory personnel in central control. While these people are not part of the normal control loop, they do exercise important functions as overseers of automatic equipment and back-ups in case of failure or emergency; A more advanced form of automation is one where the trains are unmanned, with all ATP and ATO functions performed by automatic devices. The few remaining human operators in the system are at central control, but even these personnel may be

²³Even with ATP and ATO, ATS is not truly necessary until the demands imposed by the complexity of the route structure and the required level of service outstrip the capacity for effective real-time supervision by manual methods. ATS may also become necessary when the load in peak periods approaches 100 percent of system capacity.

reduced in number as more supervisory tasks are allocated to machines.

No rail rapid transit system in the United States, or anywhere in the world, is now operating at this level of automation. The technology to do this, however, is available; and it has been applied in various people-mover systems, such as the Morgantown Personnel Rapid Transit (PRT) and several airport transportation systems. A notable example of an unmanned airport transit system is AIRTRANS at the Dallas-Fort Worth Airport, where small unmanned transit vehicles circulate on fixed guideways over a complex of interconnecting routes. The entire system is operated and supervised from a central location by a few persons aided by a train control computer,

Full Automation

Complete removal of man from control of transit system operation—even removing him from the central control point—is probably not technically feasible or desirable. For safety and continuity of operation, it will always be necessary to have someone to monitor the system and intervene to restore operations or assist passengers in an emergency. The number of such supervisors would be only a handful, however, and it is doubtful that they could ever conduct normal operations manually as a back-up to automatic systems.

Such a “fully automatic” transit would require an extremely sophisticated and costly ATC system, which would include ATP, ATO, and ATS for normal modes of operation and—most important—automatic back-ups of these mechanisms for contingencies and emergency states. The communication network would also have to be highly sophisticated, providing not only voluminous real-time interchange among automatic components but also extensive two-way voice links between passengers and the supervisory cadre. Another requirement of such a system would be automatic operation, switching, and assembly of trains in yards. The technology for automatic yard operation is available today in rudimentary form in automated freight classification yards, but it would need to be refined extensively before application to a rail rapid transit system,

Chapter 4

TRANSIT SYSTEM DESCRIPTIONS

There are eight operating rail rapid transit systems in the United States and three more in the process of planning and construction. Rail rapid transit systems are also under consideration in other cities, but none has yet reached the point where there is a definite commitment to build a rail rapid transit system in preference to some other mode of urban mass transit. Visits were made to these operating transit properties and planning agencies during the course of this study. A list of the organizations and individuals interviewed is presented in appendix F.

Five operating rail rapid transit systems were selected for detailed examination. They represent a wide range of characteristics and forms of train control technology. They vary from old to new, simple to complex, and essentially manual to highly automated. This chapter provides a brief description of the five operating systems and the three currently under development.

BAY AREA RAPID TRANSIT (BART)

System Characteristics

BART is the newest rail rapid transit system in the United States, and the most highly automated. It also serves the largest geographical area of any operating rail rapid transit system in the country. As shown in the vignette map above, the BART routes form an X-shaped pattern, whose dimensions are roughly 26 miles East-West and 30 miles North-South.

From the route map it is evident that BART serves two major purposes: to connect the East Bay suburban communities with the Oakland metropolitan area and to link all of these with San Francisco by means of the Transbay Tube under San Francisco Bay. The Oakland "Wye," a junction and switching complex at the eastern end of the

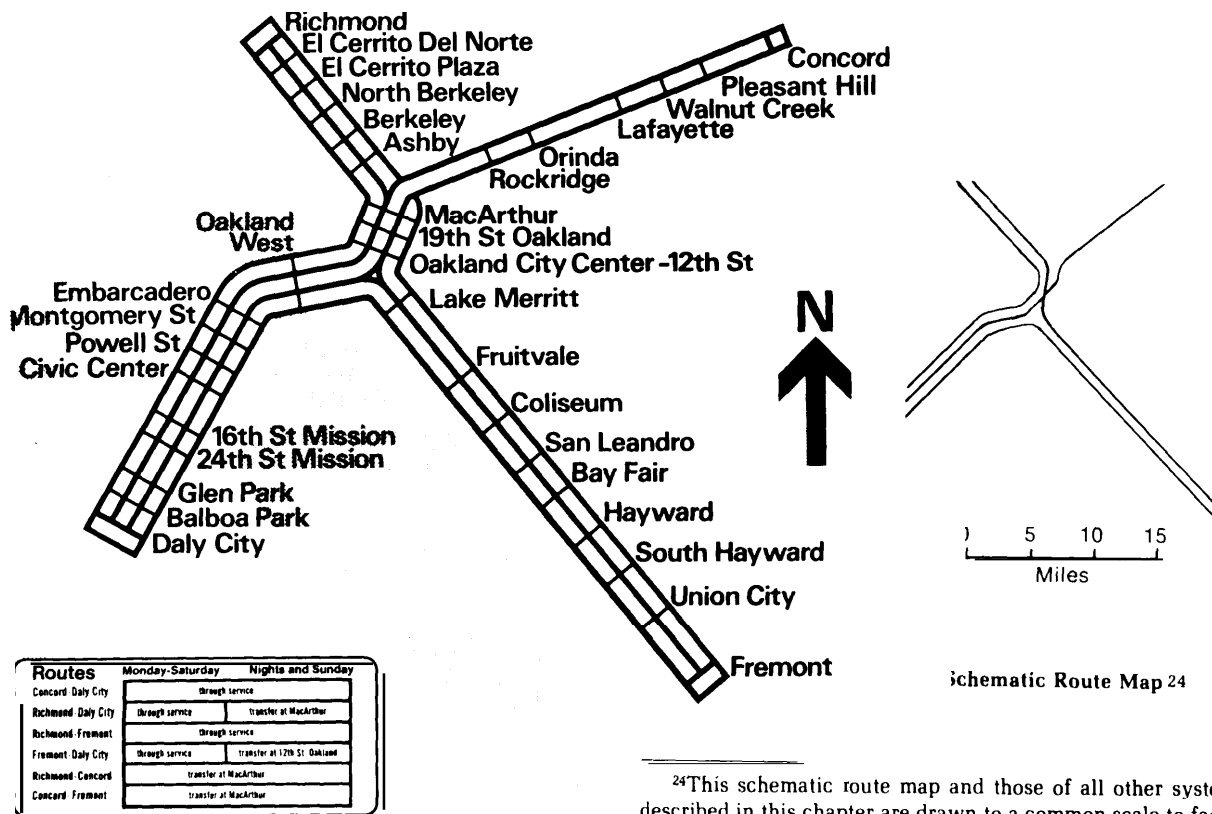

FIGURE 24.—BART Route Map

²⁴This schematic route map and those of all other systems described in this chapter are drawn to a common scale to facilitate comparison of relative size and track network density.

TABLE 2.—BART System Facts

ROUTE MILES	Surface	25	TRAIN LENGTH (cars)	Max.	10
	Elevated	23		Min.	2
	Subway	23	SPEED (mph)	Max.	80
		71		Av.	40
STATIONS	Number	34	SCHEDULED MINIMUM HEADWAY (min.)		
	Avg. Spacing (mi.)	2.1	36		
VEHICLES	Number	450	MANNING	No. in Train Crew	1
	Weight (tons)	28.5–29.5		(O&M Employees/Car) ³	2.6
	Length (ft.)	70–75	PASSENGERS	Annual (mill.)	28.8
	Capacity (psgrs.) ¹	144		Av. Weekday (thou.)	125
	Av. Age (yrs.)	2		TRAIN DEPARTURES PER DAY (each way)	
CAR MILES	(mill./yr.)	21.6			

MAIN LINE TRAIN CONTROL

Train Protection	Automatic train separation and overspeed protection with advisory cab signals, automatic rolling, and interlocking control.				
Train Operation	Automatic speed regulation, station stopping, and door operation				
Train Supervision	Centralized computer control with centralized manual control and local manual control available as back-up modes				

(1974/75 Data)

¹Full complement of seated passengers plus standees in reasonable comfort; crush load is somewhat greater.

²Will be reduced to 2 minutes when system is fully operational.

O&M (operations and maintenance) employees include O&M supervisors, but not station, administrative, engineering, planning and management personnel.

³Estimated stable year staffing.

Transbay Tube, is the engineering feature that makes it possible to provide through service, without changing trains, between any of the East Bay lines and San Francisco.

The BART system consists of 71 miles of double-track routes. " Approximately one-third of the system is underground, one-third on elevated structure, and one-third on fenced surface right-of-way with no grade crossings.

BART has a total of 34 stations (14 underground, 13 elevated, 7 surface), with an average spacing of slightly over 2 miles.

The BART fleet presently consists of 450 cars, which are of two types: A-cars, containing the

operator's cab and train control electronics, and B-Bears, which cannot operate independently in revenue service. The non control end of A-cars and both ends of B-cars are equipped with hostling panels to permit individual car movement in the yards and on storage tracks. The basic train make-up (consist) for revenue service is an A-car at either end and up to eight B-cars between. Ten-car trains are run during peak periods, Four- to six-car consists are operated in the base period.

The maximum operating speed of trains is 80 mph. The average line speed (including station stops) is about 42 mph. At present, trains operate on 6-minute headways through the Transbay Tube and on the San Francisco portion of the system. Headways are 12 minutes on the Concord and Fremont feeder routes and on the through route from Richmond to Fremont. When BART reaches its full level of service, headways will be reduced to 2 minutes in San Francisco and 6 minutes elsewhere during peak periods,

²⁵ The San Francisco Muni line, a light rail system, runs parallel to the BART line on 4 miles of underground track beneath Market Street in San Francisco. While the two share stations, the Muni system is not part of BART and is operated by a separate transit agency.

In fiscal 1974-75, BART carried an estimated 28.8 million passengers, for a total of nearly 447 million passenger-miles. Thus, the average length of a passenger trip was 15.5 miles, and the average duration 22 minutes. The average fare per ride was approximately 60¢.

ATC Features

Train control in the BART system is highly automated and accomplishes three major functions: (1) overspeed protection, assurance of safe separation between trains, and route interlocking control, (2) train operation, including station stops and door operation, (3) train supervision, including dispatching, schedule maintenance and adjustment. There is one operator on board the train, regardless of its length. The normal responsibilities of the operator are limited to surveillance of the track, monitoring of the train condition, and making passenger announcements. The operator can override certain automatic train operation functions, such as door closure, and can adjust some of the parameters of automatic operation, but the operator does not normally intervene in train protection and operation processes.

The automated equipment which carries out train control functions is partly on board the train, partly at the wayside and in stations, and partly in a central computer complex. Generally speaking, train protection and operation functions are accomplished by wayside, station and carborne equip-

ment. Dispatching and schedule maintenance and adjustment are functions of the central computer, wayside equipment, and carborne equipment.

The role of the human operator in BART, either on the train or in central control, is intended to be largely supervisory in nature. The operator can also exercise certain override and back-up functions in the event of equipment failure or unusual conditions not provided for in the computer programs. Thus, the train operator can always apply emergency braking, keep the train in the station, prevent the doors from closing, or modify the train performance mode to a more restricted level. The dispatcher at central control can manually set and cancel routes, hold trains at stations, order station run-throughs, adjust schedules, insert train identification in the computer schedule, and modify train performance—although all of these train supervision functions are normally handled by the central computer.

Problems and Issues

The BART system has been the subject of intense controversy from the very beginning. Long before the first line opened for service in 1972, critics alleged that the system was too costly and too complex, partly because of unnecessary sophistication and technological innovation in the train control system design. This complexity and reliance on unproven technology, critics contend, has also resulted in a system of lower inherent reliability and serviceability that costs more to operate and



FIGURE 25.—BART Train in Underground Station

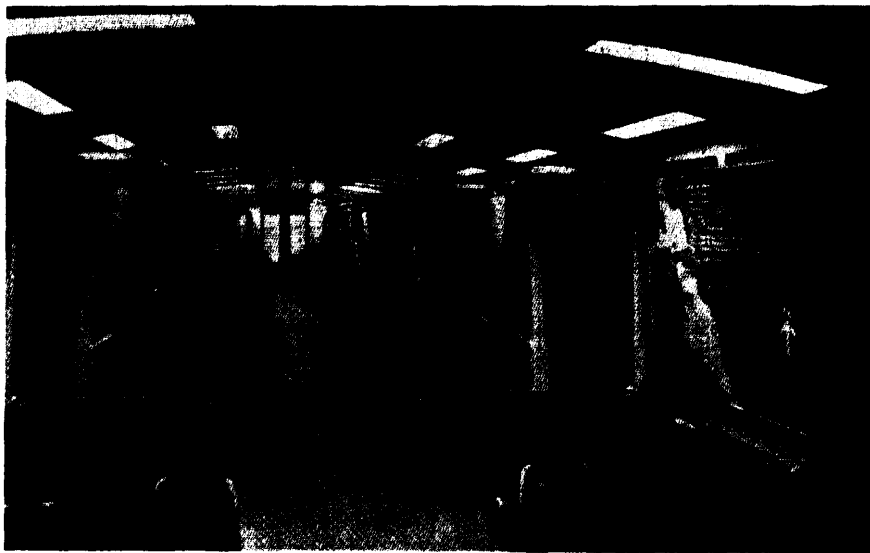

FIGURE 26.—Interior of BART Car

gives poorer service than a system employing conventional technology. It is further contended that the ATC system is basically unsafe for two reasons. First, there are automated elements that could fail and compromise the safety of train operation. Second, the human operator has been designed out of the system to the point where he has no effective means of intervention in such circumstances, except to bring the train to an emergency stop and thus degrade the performance (and perhaps the safety) of the system as a whole.

The defenders of BART rebut these charges by pointing out that the complexity is a necessary consequence of the high level of performance and sophistication required in the system engineering specifications. The design, they contend, was purposely innovative because it was necessary to break new ground in order to build a viable transportation system for a public that has had a long-standing preference for the automobile. The safety of the system is defended in two ways: on theoretical grounds, it is asserted that BART has all the fail-safe provisions of the conventional system, but accomplished in different ways that are not adequately appreciated by engineers of traditional train control equipment. On practical grounds, it is pointed out that the BART safety record is comparable to other transit systems, but operating difficulties and accidents in BART receive much greater attention because of the public controversy surrounding the system.

Fuel was added to the fire less than a month after the inauguration of service when a train ran off the end of the track at the Fremont Station. There were no fatalities and only minor injuries, but the safety of the ATC system was opened to serious question. Investigations of BART were undertaken by the California Senate, the California Legislative Analyst, the California Public Utilities Commission, and the National Transportation Safety Board. The cause of the accident was traced to a faulty crystal oscillator in the carborne electronics which, by operating at the wrong frequency, generated too high a speed command. This design defect has since been remedied by providing a redundant speed control circuit; but the investigations exposed other fundamental problems, especially in the train detection system.

As a result, the California Public Utilities Commission has issued a series of rulings which will result in additional tests and demonstrations before BART can be placed in full operation. The major area under scrutiny is the train detection system. Rail-to-rail shunting through the train axle and wheels, which decreases the signal in the track circuits and thereby indicates the presence of a train, does not always occur to a sufficient degree in the BART system. Also, there are other factors that disturb the transmission of track circuit signals and sometimes cause the train detection system to give a false indication of track occupancy. To compensate for these faults and to assure positive detection



FIGURE 27.—BART Train Passing Through the Transbay Tube

of trains at all times, a logical back-up system has been installed. This involves the use of special minicomputers at the stations to monitor the outputs of the primary track circuit detection system and to clear trains for movement only if certain logical conditions and criteria are met. These design modifications are completed and tested but have not yet been approved by the California PUC. Therefore, the BART system has not yet attained full operational status.

As BART has made the transition from design and development to operations, other problems have emerged. Reliability of equipment, particularly the cars, has been disturbingly low. Most of the time as much as half of the car fleet is out of

service for repairs. Of the trains dispatched in the morning, only about two-thirds complete the day without a breakdown. This has been compounded by problems of maintenance. Electronic components take somewhat longer to troubleshoot and repair and other types of components, and a higher level of training and skill is required in maintenance technicians. The carborne equipment is not easily accessible in some cases, requiring more time to get at the failed component or making it necessary to remove one item in order to reach another. Spare parts are in short supply. Often the troubles reported in service are intermittent and cannot be confirmed or located when the cars reach the yard or shop. The apparently healthy car is then restored to service, only to fail again in a short time.

CHICAGO TRANSIT AUTHORITY (CTA)

System Characteristics

CTA is an integrated rail-bus transit system serving the city of Chicago and 34 suburbs in Cook County. It is the second largest public transit system

in North America,²⁶ operating a fleet of 2,500 buses

²⁶The largest combined bus-rail system in North America is the New York City Transit Authority. Considering only the rail portion of the system, Chicago is also second only to NYCTA.

Rapid Transit

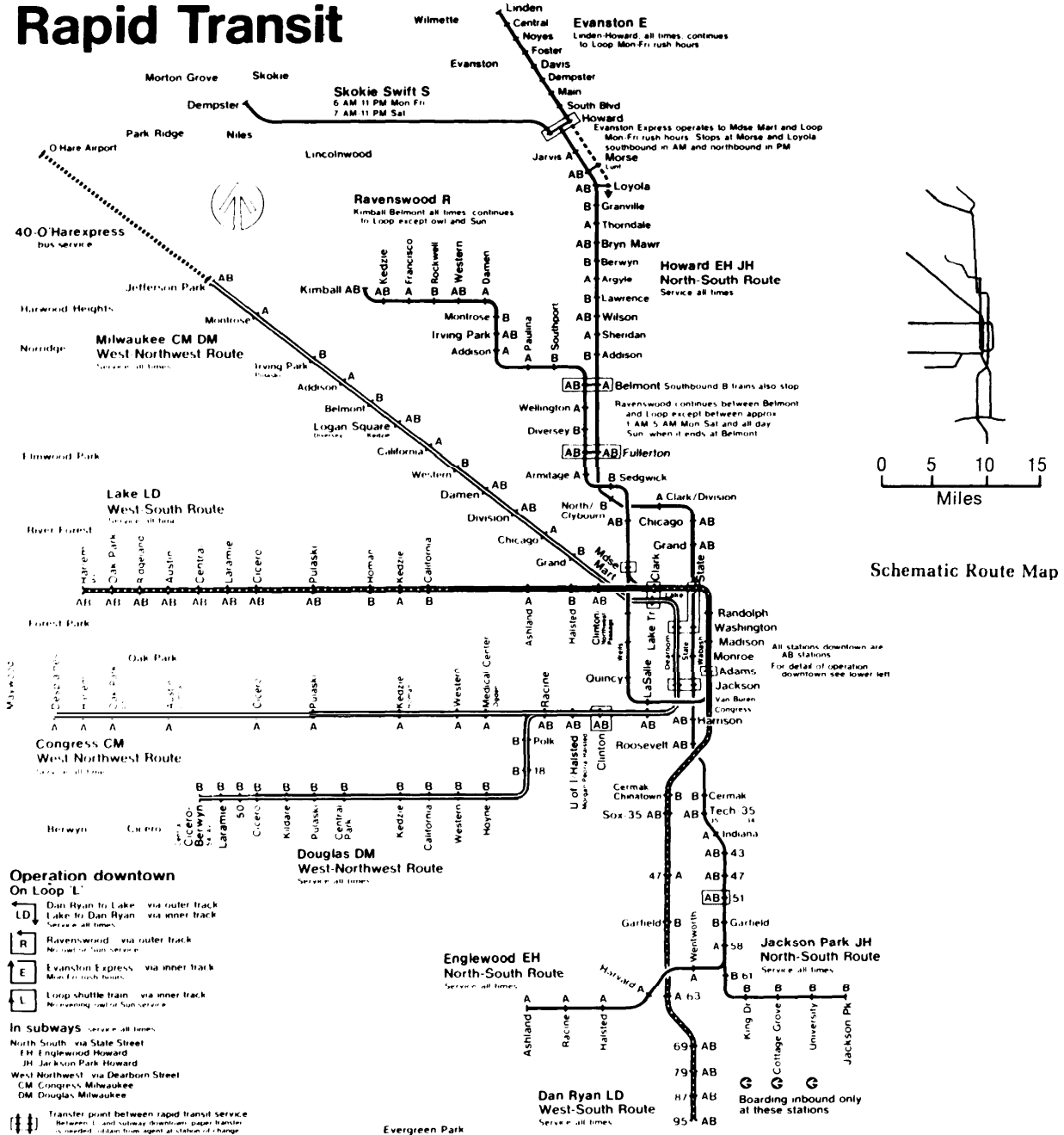

FIGURE 28.-CTA Route Map

Table 3.—CTA System Facts

ROUTE MILES	Surface	41	TRAIN LENGTH (cars)	Max.	8
	Elevated	39		Min.	1
	subway	10	SPEED (mph)	Max.	258
		90		Av.	25
STATIONS	Number	142	SCHEDULED MINIMUM HEADWAY (min.)		2 1/2
	Avg. Spacing (mi.)	0.6			
VEHICLES	Number	1,094	MANNING	No. in Train Crew	2
	Weight (tons)	20-24		O&M Employees/Car ⁴	2.2
	Length (ft.)	48	PASSENGERS	Annual (mill.)	129.2
	Capacity (psgrs.) ¹	75		Av. Weekday (thou.)	512
	Av. Age (yrs.)	16			
CAR MILES	(mill./yr.)	48.9	TRAIN DEPARTURES PER DAY (each way)		1,450

MAIN LINE TRAIN CONTROL

Train Protection Mixture of cab signals with automatic overspeed protection and wayside signals with trip stops⁵

Train Operation Manual operation

Train Supervision Mixture of centralized and local manual control

(1974 Data)

¹Full complement of seated passengers plus standees in reasonable comfort; crush load is somewhat greater.

²Newer cars are capable of 70 mph but are governed to 55 mph.

³One-man train crew on the Skokie Swift Line and the Evanston Shuttle during off-peak hours.

⁴O&M (operations and maintenance) employees include O&M supervisors, but not station administrative, engineering, planning and management personnel.

⁵When current TV program installations are complete in the spring of 1976.

and 1,100 rail rapid transit vehicles. The rail portion of the system consists of seven lines, of which all but the Skokie Swift line pass through or circulate within the downtown area. Two of the six downtown lines are in subways, entering and leaving by tunnels under the Chicago River. The remaining four are elevated lines that run on common tracks on the Loop El. Access to the loop area is over two bascule bridges, which are raised several times daily during the navigation season to permit the passage of ships. Thus, the throughput for over half of the CTA system is determined by the volume of traffic that can be accommodated on the tracks of the 75-year-old Loop El structure and its associated movable bridges.

CTA operates a total of 90 miles of routes (191.6 track-miles). Almost half (41 miles) are at grade. Elevated routes comprise 39 miles, and subway routes 10 miles. There are 142 stations (41 surface,

85 elevated, 16 subway), with an average spacing of about two-thirds of a mile,

CTA maintains a fleet of 1,094 cars, consisting of five types. All but four cars used on the Skokie Swift Line are 48 feet in length and of conventional steel construction. Their weight is between 40,500 and 47,000 pounds, depending on the type. The 2000-, 2200-, and 6000-series cars are operated as "married pairs," consisting of a permanently coupled A-car and B-car. The pairs can be operated from either end as two-car trains, and they can be joined with other pairs to form trains of up to eight cars in length. The fourth type of car (the 1-50 series) is designed to operate as a single and has an operator's cab at either end. The 1-50 series cars can also be joined to form trains. The fifth type is a three-compartment, articulated car, of which there are only four, all assigned to the Skokie Swift line. These cars are about 89 feet long and weigh 93,000

pounds. The rolling stock is of varied age. The 6000-series cars are almost 25 years old; the 2200-series was acquired in 1969–70. The average age of the cars is about 16 years.

Trains of one to eight cars are run in peak periods on headways that range from 2 to 6 minutes for individual lines. The maximum speed of trains is 50 to 58 mph, depending on the type of equipment. Average speed is between 20 and 30 mph. Two factors combine to keep the average speed relatively low—close station spacing (0.64 mile, average) and the nature of the right-of-way. Four lines operate, for at least some portion of their route, on the elevated tracks of the Loop El. This structure, which dates from the turn of the century, has extremely sharp turns (90-ft. radius) that must be negotiated at low speed. The Loop El is also a congested part of the system; the four lines using it operate on a composite headway of about 1 minute at peak periods.

Including originating passengers and transfers from bus routes, the CTA rail rapid transit system carried a total of 126.8 million passengers in 1973 and an estimated 129.2 million in 1974. The average length of a passenger trip is about 7.9 miles or 16 minutes (compared to 15.5 miles and 22 minutes in BART). The average passenger fare is roughly 28 cents per ride.

ATC Features

The train control system in CTA has undergone extensive change since the property was acquired from the Chicago Rapid Transit Company in 1947. At that time, trains were operated almost completely under manual control by the motorman using visual observation and compliance with rules to regulate speed, station stopping, and following distance behind other trains. Color-light wayside block signals existed over about 10 percent of the trackage, mainly on curves and in the subways. Wayside signals with trip stops for train protection were installed only in the State Street subway (about 10 track-miles). In all other areas, the motorman had no display of information in the cab or at the wayside, except signposts advising of speed limits on curves or downgrades. The train crew consisted of a motorman, a conductor, and sufficient guards to man the doors, collect fares, and provide passenger information. Only a few cars had door controls sufficiently sophisticated to permit a trainman to operate the door at the far end of a car, so

that trains required a crew of two to seven men, depending on length and type of cars,

Between 1947 and 1960, CTA installed wayside signals with trip stops in the remaining portions of the subway lines and some of their extensions. The elevated lines in the Loop, however, remained un-signaled; and train control was still essentially a manual operation accomplished by the motorman, with the assistance of towermen at interlocking.

In 1965, CTA began to install cab signaling, first on the Lake portion of what is now the West-South line and then the new Dan Ryan and Kennedy extensions, which were opened for service in 1969 and 1970, respectively. By 1974 the conversion to cab signaling was completed on the West-Northwest and North-South lines. The remaining lines—Skokie Swift, Ravenswood, and Evanston (including the Loop El)—are scheduled for conversion in early 1976. At the completion of the project, about 75 percent of the system will be cab signaled, and the remainder will be protected by stop-enforcing wayside signals.

With the installation of cab signaling, CTA has gone from the almost completely manual system to a semiautomated form of operation. Train separation and overspeed protection are automatic. Train operation is manual, but with machine-aiding of the motorman by means of the cab display unit. Supervision of trains (schedule maintenance, traffic monitoring, and routing) are essentially manual operations accomplished by dispatchers in central control or by towermen at interlocking, with some remote control and automatic interlocking.

Except for the Skokie Swift and off-peak Evanston shuttle trains, which are manned by a single operator, all CTA trains have a two-man crew. The motorman operates the train from the cab and controls all movement. The conductor, stationed at least one car length to the rear of the motorman, controls the opening and closing of doors at stations and makes passenger information announcements. At certain stations, during off-peak hours when collection booths are closed, the conductor also receives fares.

Thus, the human operator (especially the motorman) plays an indispensable role in the CTA system. Except for train protection and speed limit enforcement performed by wayside or cab signaling, the motorman controls the operation of the train. The skill with which propulsion and braking



G R E — C A h W N h w R h M d h K d E p w



FIGURE 30.—Interior View of CTA Train
(Note conductor at rear of car.)

are handled determine the smoothness of the ride, the precision of station stops, the adherence to schedule, and the response to incursions on the right-of-way.

Problems and Issues

The basic problems facing CTA are typical of the mature rail rapid transit systems in this country. The right-of-way, structures, rolling stock, and signals are in need of modernization or replacement,

There is also a need to expand the service in response to the growth and extension of the metropolitan area. Paradoxically, however, the patronage of CTA has been declining in recent years. The ridership for the combined bus and rail system in 1973 was off about 24 percent (about 188 million passengers) from that of 1966, a drop of roughly 3 percent per year.²⁷ The figures for 1974 show an upturn (30 million), which may indicate a switch by the public away from the automobile as a result of a growing concern with energy usage and conservation of resources. While the revenues from transit operations have generally declined, the costs have risen. This has created mounting operating deficits, which amounted to \$22.1 million for CTA in 1973, despite nearly \$37 million in emergency grants from State, county, and municipal funds. CTA thus finds itself in a position where it must expand and improve the system to meet public needs, but with a shortage of farebox resources to do so.

The conversion to cab signaling was motivated by more than a desire to modernize the system and thereby attract more patrons. There was also a fundamental concern with the safety of a system which offered only a very limited level of signal protection. Operation of trains on rather close headways by means of visual reference and procedural separation created safety problems. CTA has had an inten-

²⁷Includes originating and transfer passengers.

sive safety training and awareness program since 1954. While this has resulted in a steady and heartening decline of 40 percent in the traffic and passenger accident rate over 20 years, the problems of collisions and derailments persisted. Between 1964 and 1974 there were 35 collisions between trains which resulted in injuries and 48 derailments (only seven of which produced passenger injuries). This amounted to eight mishaps per year, or one about every 6 weeks.

Human operator error was determined to be a causal factor in every collision. Typically, the motorman either failed to observe a train ahead, did not maintain the proper following distance, or misjudged the stopping distance. In derailments, about half of the accidents were also caused by human error or improper operation (most commonly switching mishaps or overspeed on curves). The installation of a modern cab signaling system was seen by CTA as the way to prevent these types of accidents. On theoretical grounds, this would appear to be a very effective measure, but it is still too early to draw any firm conclusions from CTA operating experience since the conversion to cab signals.

The cab signaling program has brought with it certain new operational problems. The reliability of the new equipment, particularly during the transitional period, has been rather low. CTA engineers

have found that the installation and debugging process takes several months: but, when completed, cab signals do not pose an inordinate maintenance problem from the point of view of equipment reliability.

Another aspect of cab signal conversion which represents a problem is in the area of human factors. Installation, checkout, and servicing of the equipment calls for new skills in maintenance personnel. CTA has encountered a shortage of qualified signal maintainers and has had to undertake an extensive training (and retraining) program for shop personnel. Train operators, too, have had to be instructed in the use of the cab equipment, and there is some anecdotal evidence that the process of learning to run the train in this new mode of operation is taking longer than expected.

The long-range program for CTA involves two major undertakings in the area of train control. First is the replacement of the antiquated Loop El with a modern subway system. A part of this project will be installation of a cab signaling system for all underground lines in the downtown area. The second project will involve the incorporation of more automation in train supervisory and dispatching functions. This includes installation of a modern model board in central control and computer aid for schedule maintenance and adjustment.



FIGURE 31.—Lake-Dan Ryan Train Entering the Loop

TABLE 4.—MBTA System Facts

ROUTE MILES	Surface	16	TRAIN LENGTH (cars)	Max.	4
	Elevated	4		Min.	2
	subway	10	SPEED (mph)	Max.	² 50
		3 0		Av.	³ 20
STATIONS	Number	43	SCHEDULED MINIMUM HEADWAY (min.)		2 1/2
	Avg. Spacing (mi.)	0.7			
VEHICLES	Number	354	MANNING	No. in Train Crew	2- 3
	Weight (tons)	22-35		O&M Employees/Cars	3.0
	Length (ft.)	48-70	PASSENGERS	Annual (mill.)	85
	Capacity (psgrs.) ¹	125-250		Av. Weekday (thou.)	283
	Av. Age (yrs.)	18			
CAR MILES	(mill. /yr.)	10.3	TRAIN DEPARTURES PER DAY (each way)		590

MAIN LINE TRAIN CONTROL

Train Protection Mixture of cab signals with automatic overspeed protection and wayside signals with trip stops

Train Operation Mixture of manual operation and automatic speed regulation

Train Supervision Mixture of centralized and local manual control

(1974 Data)

¹Full complement of seated passengers plus standees in reasonable comfort; crush load is somewhat greater.

²Newer cars on the Red Line are capable of 70 mph but are governed to 50 mph.

³Average speed of new cars on the Red Line is about 30 mph.

⁴Train crew consists of motorman and one train guard (conductor) for each pair of cars.

⁵O&M (operations and maintenance) employees include O&M supervisors, but not station, administrative, engineering, planning and management personnel.

route are in subways, and 4 are on elevated structure. All trackage in the central business area of Boston is underground. MBTA has 43 stations (20 subway, 17 surface, 6 elevated), with an average spacing of about 0.7 mile.

A distinguishing feature of the system is the age and diversity of the rolling stock. Five different types of cars are in operation. The cars on the Blue Line are oldest, consisting of 40 cars dating from 1923 and 48 from 1953. They weigh **44,000 and 46,000** pounds, respectively, and are **48 and 49** feet in length. Orange Line cars are 17 years old, weigh 58,000 pounds, and have an overall length of 55 feet. The Red Line has the newest equipment--90 so-called "Bluebirds" acquired in 1963 and 76 "Silverbirds" acquired in 1970. Both types are 70 feet long. The Silverbirds weigh 64,000 pounds, and the older Bluebirds 70,000 pounds. All cars are operated as

married pairs in consists of two or four. Some of the Red Line Silverbirds are capable of single-car operation, but they are not so used at the present time.

Because there is no connecting trackage and common yards and because of varying platform heights and car widths, cars cannot be exchanged between lines. In effect, MBTA operates as a system with three separate parts, linked only by passenger transfer stations where routes intersect. One consequence of this arrangement is a fleet with a relatively high proportion of reserve cars—about 150 in a fleet of **354, or 43** percent.

Another distinguishing feature of MBTA is the composition of the train crew which, in addition to the motorman, is made up of one train guard (conductor) for each pair of cars. The rush hour consist of four cars thus requires a crew of three. The train

guards are stationed either on a platform between each pair of cars or inside at the rear of each pair of cars and are responsible for door operation. The origin of this manning formula is obscure, but it is reputed to be a safety measure for emergencies or breakdowns, where the train guards could help evacuate passengers. It may also be a carryover from the time when sophisticated door operating equipment was not available, and a pair of cars was all that one person could handle. Whatever the origin, this manning formula is now a part of the contract with the labor union and has not been changed even though all MBTA cars are equipped with doors that can be operated by one man regardless of train length.



R MB O



FIGURE 34.—Red Line Train Arriving at Wollaston Station

Depending on the type of car, the maximum design train speed is between 30–70 mph—the newer equipment having the greater top speed. However, because of close station spacing and Massachusetts Department of Public Utilities safety

rules, train speed is governed to 30 mph on the Blue Line, 35 mph on the Orange Line, and 50 mph on the Red Line. Average line speed (including station stops) is between 20 and 28 mph. Trains are operated on headways of 2½ to 3½ minutes in peak periods and 4½ to 9 minutes in the base period.

In 1974, MBTA carried a total of 85 million passengers. Average weekday patronage was approximately 283,000, including bus and light rail transfer passengers. The typical passenger trip is about 3.1 miles in length and consumes a little less than 8 minutes.

ATC Features

MBTA has only a minimal level of train control automation. Most of the system (all but the Andrew-Quincy Center branch of the Red Line) has wayside signals and trip stops for train in separation and automatic interlocking control but no other ATC features. Since 1971, the Andrew-Quincy Center (or South Shore) branch of the Red Line has been equipped for cab signals. However, the Massachusetts Department of Public Utilities has not yet authorized cab signal operation because of questions as to the safety of the installation. As an interim measure, Red Line trains are run on a “manual block” system with one-station separation between trains. Under this procedure, a following train may not leave a station until a radio message has been received from a dispatcher that the leading train has departed.

Train operation (speed regulation, station stops, and door control) is manual, except for Silverbird cars, which are equipped with automatic speed regulation. There is some machine-aiding of the motorman in running the train, in the form of slip-slide control (for Silverbirds only).

Train supervision is essentially manual, except for automatic train dispatching devices. Train progress is monitored by personnel at central control by means of three separate train boards (one for each line), activated by track circuits. Contact with individual trains and with wayside and station personnel is maintained from central control by voice radio. Except for a few locations equipped with automatic interlocking to control train turnaround at terminals, all route assignment functions are performed manually.

Problems and Issues

MBTA is an old system in the process of modernization and transition. Rolling stock on the Orange and Blue Lines is approaching the end of its service life and will be replaced with the help of a recently received \$70 million grant from UMTA. Track, way, and structures in older parts of the system are being refurbished, and extensions of the lines are under construction or in the planning stage.²⁸ The power generation and distribution system²⁹ is antiquated and no longer adequate to meet demand. A long-range program of replacement is underway.

Like other parts of MBTA, the signal and train control system is undergoing modernization. Here, the situation is much like that in CTA a few years ago at the start of their cab signal conversion program. There is wayside signal and trip stop protection on most lines and the beginnings of a conversion to cab signaling on two extensions (the Red Line Quincy branch and the Orange Line Wollaston extension). The remainder of the Red Line is scheduled for conversion to cab signaling, and the new cars for the Orange and Blue Lines will be equipped with cab signal equipment to permit eventual conversion of these lines too,

The Red Line cab signal installation has had several problems. The Massachusetts Department of Public Utilities has not yet certified the safety of the installation, DPU concern centers in two areas: the reliability of the equipment and the possibility of incorrect speed commands. Pending DPU approval, the Red Line has been operating under a manual block system (in effect, without cab signals) since 1971,

The operational experience with cab signals has been disappointing. In addition to problems of

²⁸The Wellington extension of the Orange Line opened for service in September 1975.

²⁹MBTA, unlike other transit systems, still generates much of its propulsion power (25 Hz a.c.). New lines and most stations, however, run on 60 Hz a.c. power purchased from local utility companies.

reliability, there have been maintenance difficulties. Shop facilities have not been adequate.³⁰ Spare parts are in short supply. There has been insufficient funding for maintenance work, with the result that not enough repairmen can be hired. Cab signal equipment tends to need maintenance more often and to require more maintenance time than other kinds of transit equipment. MBTA maintenance supervisors estimate that a major part of the maintenance effort is devoted to repairing breakdowns, with the result that preventive maintenance and overhaul must be somewhat slighted.

A complicating factor in the maintenance situation is the shortage of qualified maintenance personnel. Union rules permit transportation department employees (motormen and train guards) with seniority to bid for openings in car shop jobs without regard for work skills and experience. The limited funding available for maintenance does not allow a complete formal training program for such personnel, who must receive much of their training on the job by informal methods. This has not proven to be an effective way to develop the skills needed for maintenance of sophisticated electronic equipment.

The problems of MBTA are typical of a system in transition to a new form of technology. Installation and checkout of new equipment disrupts the established pattern of operation and maintenance. The new equipment must be integrated with the existing system. Debugging is a troublesome process. Learning to make effective use of the equipment takes time and places demands on the labor force to adapt to new procedures and techniques. The entire system must find a new equilibrium. MBTA, like other older transit systems, is finding that the process of incorporating new technology is not always smooth and trouble-free.

³⁰MBTA is currently building three modern rail transit maintenance facilities, the first two of which (for the Red Line and the Orange Line extension) were dedicated in 1975.



Tower C, at one time the busiest control and interlocking tower in the MBTA system, now replaced by a modern automated facility.

Remodeled
Arlington St.
Station.



Construction of the
new Community College
Station on the Orange
Line Extension.
(Overhead is Interstate
Highway I-93.)

FIGURE 35.—The Old and The New

NEW YORK CITY TRANSIT AUTHORITY (NYCTA)

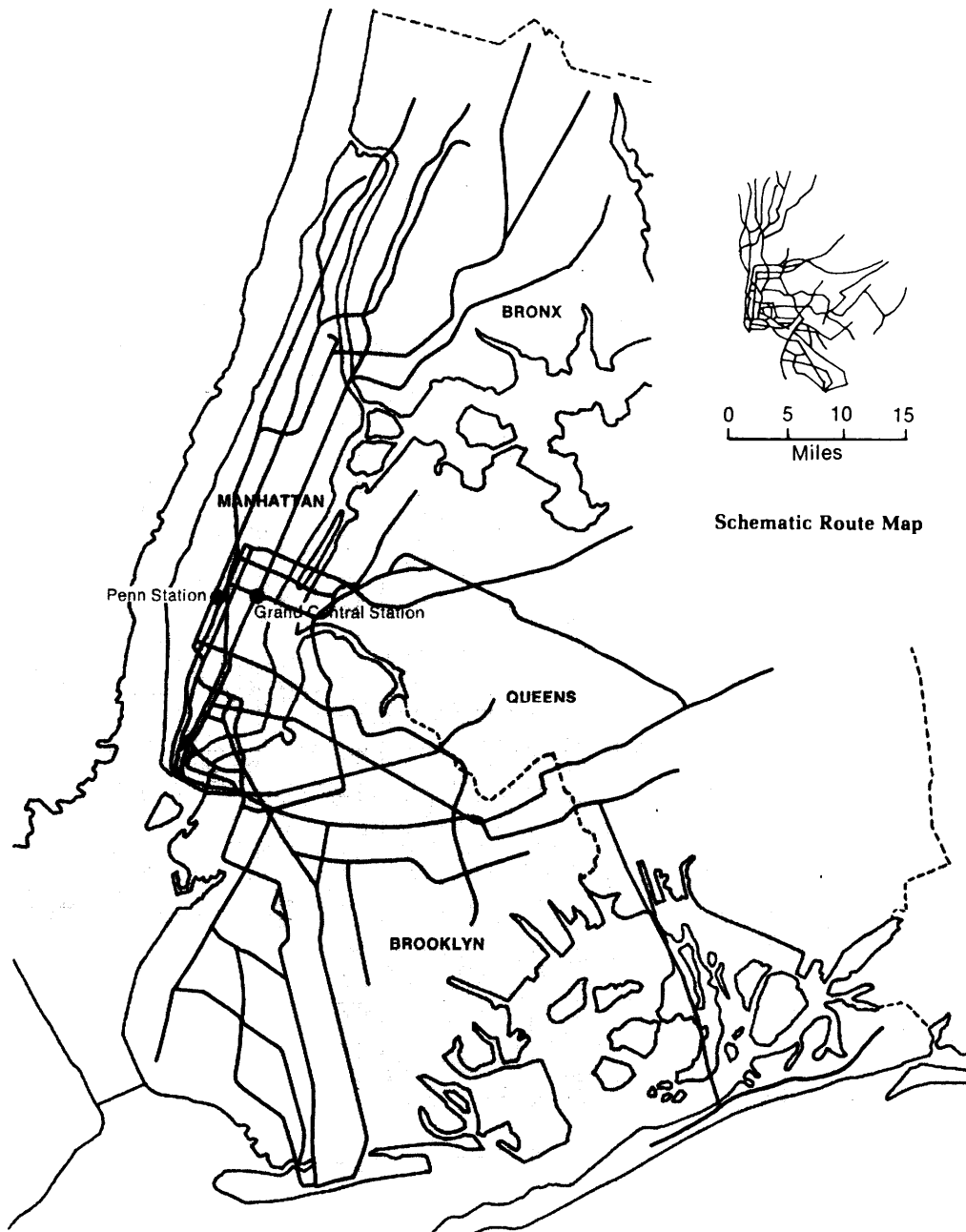

FIGURE 36.—NYCTA Route Map

System Characteristics

NYCTA is the largest and most complex rail rapid transit system in the United States. NYCTA has more route-miles than BART, CTA, MBTA, and PATCO combined; and it has approximately

half of the total rail rapid transit track-miles in the country. On an average weekday NYCTA carries more passengers than the total population of Chicago. Of the roughly 2 billion rail rapid transit passengers in the United States each year, half are NYCTA patrons. NYCTA has almost 29,500

TABLE 5.—NYCTA System Facts

ROUTE MILES	Surface	23	TRAIN LENGTH (cars)	Max.	11
	Elevated	72		Min.	2
	Subway	137	SPEED (mph)	Max.	50
		232		Av.	20
STATIONS	Number	463	SCHEDULED MINIMUM HEADWAY (min.)		1 1/2
	Avg. Spacing (mi.)	0.5			
VEHICLES	Number	16,681	MANNING	No. in Train Crew	2
	Weight (tons)	34-43		O&M Employees/Car ^d	3.1
	Length (ft.)	51-75	PASSENGERS	Annual (mill.)	1,036
	Capacity (psgrs.) ²	136-204		Av. Weekday (thou.)	3,740
	Av. Age (yrs.)	17			
CAR MILES	(mil./yr.)	320.6	TRAIN DEPARTURES PER DAY (each way)		8,000
MAIN LINE TRAIN CONTROL					
Train Protection	Wayside signals with trip stops				
Train Operation	Manual operations				
Train Supervision	Mixture of centralized and local manual control				

(1974/75 Data)

¹Does not include 754 new R-46 cars now being delivered.

²Full complement of seated passengers plus standees in reasonable comfort; crush load is somewhat greater.

³Local service; express service averages about 28 mph.

⁴O&M (operations and maintenance) employees include O&M supervisors, but not station, administrative, engineering, planning and management personnel.

⁵The newer R-44 and R-46 series cars are equipped for automatic speed regulation and programmed station stopping in anticipation of use on planned or new lines and extensions.

employees,³¹ not counting the 5,100 transit police who constitute the eighth largest police force in the United States. The annual operating budget for NYCTA in 1974-75 (\$951 million) is equivalent to 10 percent of that of the entire U.S. Department of Transportation for FY 1975 and only slightly less than the DOT funds budgeted for all of mass transit and railroads in the same period (\$965 million).

The complexity and density of the NYCTA network can be appreciated by comparing the schematic route map above with those of other systems. The geographic area served by NYCTA is roughly 15 x 20 miles, which is only slightly larger than the CTA area but less than half that covered

by BART. Within this area, however, NYCTA operates 29 routes (26 regular, 3 shuttle) as compared to 7 in CTA and 4 in BART. Expressed as the ratio of route-miles to area served, NYCTA has 0.77 miles of transit route per square mile; CTA and MBTA have 0.36; and BART has 0.09. In other words, the NYCTA network is about twice as dense as CTA and MBTA and eight times denser than BART. Density alone, however, does not account for the whole difference between NYCTA and other systems since the complexity of the system increases exponentially as a function of the number of lines on common tracks. In NYCTA virtually all the lines in Manhattan and Brooklyn share track with at least one and as many as three other lines.

³¹ NYCTA also employs about 8,600 in bus operations, making a total workforce of 38,066 (43,167 including police).

The NYCTA system is made up of two operating divisions—Division A (the former IRT lines) and

Division B (the former BMT and IND lines)³²—comprising 232 miles of route. Over half of the route-miles are in subways (127 miles). There are 72 miles of elevated route and 23 miles on protected surface right-of-way. NYCTA has 463 stations (265 subway, 160 elevated, 38 surface), with an average spacing of 0.5 mile.³³

The fleet consists of 28 different types of cars, ranging in age from R-1 series (1930) to the R-46 series acquired in 1975. The newest equipment (300 R-44 cars and 754 R-46 cars) is 75 feet in length and weighs 80,000 and 86,000 pounds, respectively. Older equipment (the R-38 to R-42 series) is 60 feet long and weighs 68,000 to 74,000 pounds. There are also about 1,600 51-foot cars acquired in 1946-58. The total fleet now numbers 6,681 and will grow somewhat when delivery of the R-46 series is completed and older equipment is phased out.

Platform length and operating practice govern the size of the peak period consist, which is eight 75-foot cars, ten 60-foot cars, or eleven 51-foot cars. The maximum operating speed of trains is 50 mph. The average line speed (including station stops) is 18.5 mph for local service and about 28 mph for express trains. Minimum peak period headway on an individual line is scheduled at 2 minutes, but the signal system is designed for 90-second headways. The composite headway at some interlocking may be as short as 50-60 seconds.

In fiscal year 1973-74, NYCTA carried 1,096 million passengers for a total of 5,480 million passenger-miles. Average weekday ridership was about 3.7 million. Only slightly more than half of these riders (53 percent) were carried in the rush hours.³⁴ This suggests a unique pattern of ridership for NYCTA in comparison with other U.S. systems, New Yorkers tend to use the NYCTA throughout the day (not just for trips to and from work) and for short trips. The average trip length is estimated to be slightly over 5 miles and to take about 17 minutes.³⁵

³²IRT—Interborough Rapid Transit, BMT—Brooklyn Manhattan Transit, IND—Independent.

³³This is **spacing** between local stations. The spacing of express stations is greater, on the order of 1 mile.

³⁴In other systems, peak-period **ridership** customarily accounts for about two-thirds of the daily traffic.

³⁵**Trip length is also** partially a function of the compactness of the boroughs of Manhattan and Brooklyn where most trips occur.

ATC Features

NYCTA has a relatively low level of automation. Train protection (train separation and interlocking control) is accomplished automatically by wayside signals with trip stops to prevent block violation. Some portions of the system (principally curves and grades in the subways) also have time signals and trip stops for overspeed protection, but elsewhere this function is accomplished manually by the motorman using operating rules and posted civil speed limits.

Train operation is manual. The crew is two (motorman and conductor), regardless of train length. The train is under the control of the motorman who regulates speed by estimation. (There is no speedometer in the cab except for the new R-44 and R-46 cars.) Station stopping and door control are manual operations—the former by the motorman, the latter by the conductor.

Except for automatic train dispatching equipment, automatic train identity systems, and some automatic interlocking, train supervision is manual. Scheduling, route assignment (except at automatic interlocking), and performance monitoring are performed by supervisory personnel at central control and by towerman at remote locations. Train supervision is somewhat more decentralized in NYCTA than in other systems, primarily because the size and complexity of the system make central control by manual means impractical. Automated train identification equipment is used in some locations, but for most of the system this function is performed by manual methods. Computer-assisted maintenance scheduling and record keeping is employed. Equipment for automatic recorded passenger information announcements is installed at some stations, primarily major transfer points.

Problems and Issues

NYCTA has embarked upon an ambitious program of modernization and expansion. More than 1,800 new cars have been delivered or are on order. New lines to ease the congestion in heavily traveled corridors are in the planning stage. These new lines, notably the proposed Second Avenue line, will have cab-signaled ATP and ATO. It is also planned to upgrade train control on existing lines over a 20-year period by converting to cab-signaled ATP. Another part of this modernization program, already in progress, is installation of a centralized



FIGURE 37.—IND F Train on Elevated Line in Brooklyn



M



R-16 BMT-IND (1953)



R-36 IRT (1962)



R-44 BMT-IND (1970)

FIGURE 38.—Examples of NYCTA Transit Cars

communication center for train supervision at NYCTA headquarters in Brooklyn. A new two-way train radio and police communications system has recently been completed.

Continuing, and worsening, deficits in transit operations have recently been forced a cutback in the program. Funds intended for system improvement have had to be siphoned off to meet operating expenses. The financial crisis of New York City as a whole has also had an impact on NYCTA, forcing even further curtailments in the planned new transit lines and procurement of replacement equipment.

The new R-44 and R-46 series cars are equipped with cab signal units; but since the associated track and wayside equipment has not yet been installed, trains are run with cab signals deactivated, relying on wayside signal and trip stop protection. The maintenance and reliability problems that have been encountered with the R-44 cars and with the recently delivered R-46 cars are thus not ATC problems, and there is no way of estimating what influence the ATP and ATO equipment of these cars may have on car availability.

The gravest maintenance problem for the NYCTA has nothing to do with ATC as such, but does influence the ability of the shop force to keep train control equipment running. The NYCTA has been stricken with an epidemic of vandalism. The most obvious form is graffiti, which completely covers the outside and inside of cars. Officials estimate that 95 percent of the cars are defaced on the outside and 80 percent on the inside. There is also extensive breakage of windows, safety equipment, train radios, and motorman consoles. The vandalism even extends to yards and track equipment. The Flushing line averages 40 broken windows a day, and 70 or more trains are vandalized (and often rendered unserviceable) on the BMT each week. The funds and maintenance force that must be committed to coping with the damage are of such magnitude that other forms of corrective and preventive maintenance suffer.

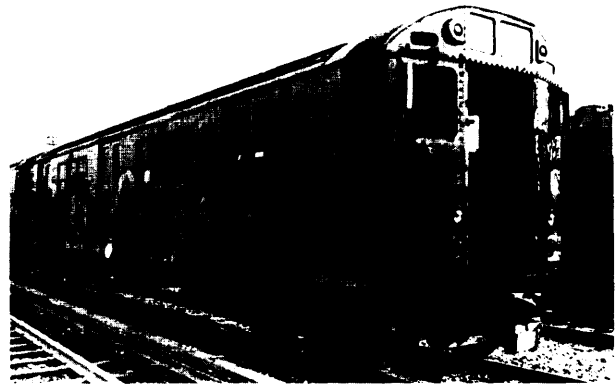

FIGURE 39.—The Graffiti Epidemic

PORT AUTHORITY TRANSIT CORPORATION (PATCO)

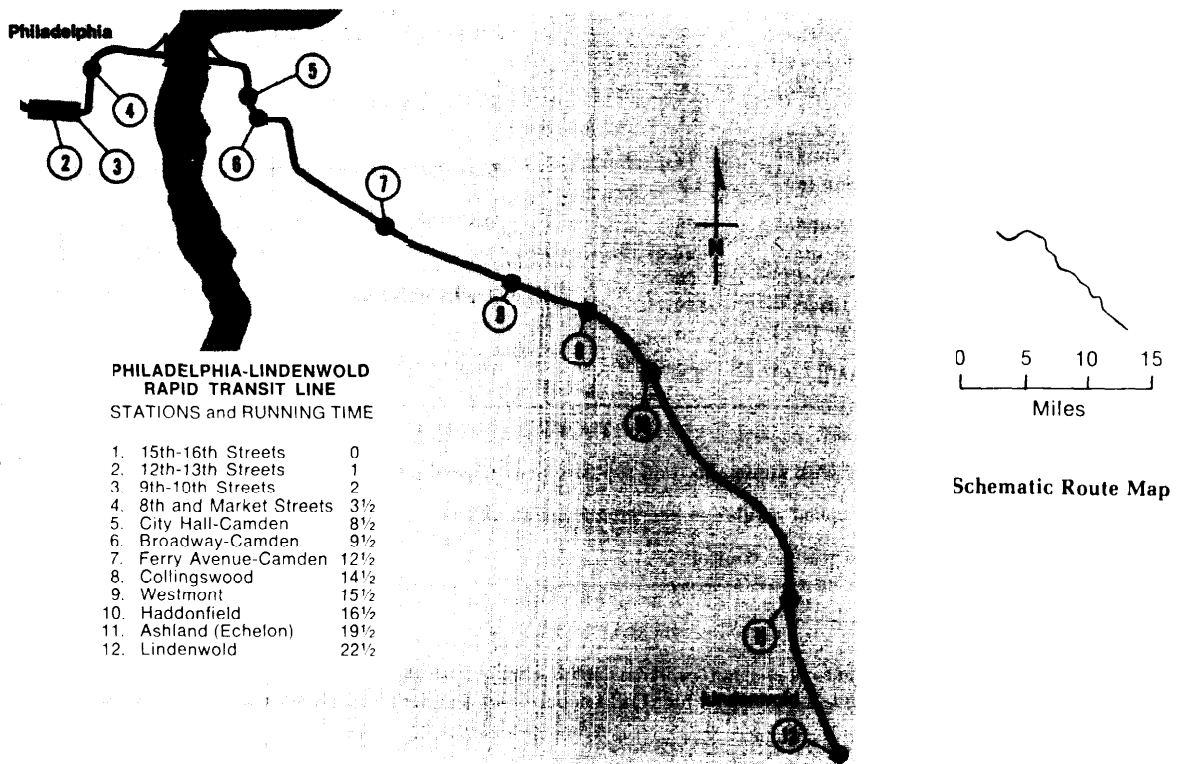

FIGURE 40.—PATCO Route Map

System Characteristics

PATCO, also known as the Lindenwold Hi-Speed Line, consists of a single route connecting seven southern New Jersey suburban communities with the city of Philadelphia. PATCO is a hybrid system, resembling a commuter railroad in suburban New Jersey and a subway transit system in downtown Camden and Philadelphia. The Camden-Lindenwold segment of the line was opened for operation in January 1969; through service to Philadelphia over the Benjamin Franklin Bridge began a month later. The line is owned by a New Jersey -Pennsylvania bi-State agency, the Delaware River Port Authority (DRPA).

Like BART, PATCO was planned and built as an alternative to another automobile bridge or tunnel to link the growing suburbs and a central business

area separated by a body of water.³⁶ The evidence accumulated in its 6-year history suggests that PATCO has been successful in winning the patronage of the automobile driver. Surveys have shown that about 40 percent of PATCO patrons are former motorists. It has also been established that PATCO now carries about 30 percent of all daily commuter trips between South Jersey and center-city Philadelphia. A side benefit is that PATCO has served to reduce traffic congestion on parallel highway arteries. For instance, the average rush hour speed on White Horse Pike (running alongside the PATCO line) increased by 30 percent from 1960 to

³⁶Unlike BART, however, PATCO did not involve building a separate water crossing. PATCO trains run on right-of-way of the former Camden-Philadelphia Bridge line on the Benjamin Franklin Bridge.

TABLE 6.—PATCO System Facts

ROUTE MILES	Surface	9	TRAIN LENGTH (cars)	Max.	6
	Elevated	1		Min.	1
	Subway	4	SPEED (mph)	Max.	75
	14	Av.		40	
STATIONS	Number	12	SCHEDULED MINIMUM HEADWAY (min.)		
	Avg. Spacing (mi.)	1.2	2		
VEHICLES	Number	75	MANNING	No, in Train Crew	1
	Weight (tons)	39		O&M Employees/Car ²	2.7
	Length (ft.)	68	PASSENGERS	Annual (mill.)	11.2
	Capacity (psgrs.) ¹	120		Av. Weekday (thou.)	40
	Av. Age (yrs.)	6			
CAR MILES	(mill./yr.)	4.3	TRAIN DEPARTURES PER DAY (each way)		
182					

MAIN LINE TRAIN CONTROL

Train Protection	Cab signals with automatic train separation, overspeed protection, and interlocking control
Train Operation	Automatic speed regulation and programed station stopping
Train Supervision	Centralized manual control

(1974 Data)

¹ Full complement of seated passengers plus standees in reasonable comfort; crush load is somewhat greater.

² O&M (operations and maintenance) employees include O&M supervisors, but not station, administrative, engineering, planning and management personnel.

1970, primarily as a result of the start-up of rail rapid transit service.

The PATCO line is approximately 14 miles long (9 miles on surface right-of-way or in cuts, 1 mile on elevated structure, and 4 miles of subways in Camden and Philadelphia). There are 12 stations (6 elevated or surface and 6 subway), with an average spacing of 1.2 miles.

The car fleet is made up of 75 vehicles—25 married pairs and 25 singles. The married pairs are semipermanently coupled A-cars and B-cars, containing one set of train control equipment per pair, and may be operated from either end. The singles are double-ended cars, capable of independent operation or of running in trains with other singles or married pairs. The cars all weigh about 78,000 pounds and are 67.5 feet in length. Capacity, with standees, is about 120 passengers in the A-cars or B-

Bears and slightly less in the singles, because of the two operator cabs. Six-car trains are run in peak periods, two-car trains in base periods, and single cars nights and Sundays.

The cars are designed to run at 75 mph, a speed which is regularly attained on the suburban portions of the line. Maximum operating speed on the bridge and in tunnels is considerably lower (15–40 mph) because of grades and curvature. The average speed for an entire run, including station stops, is about 38 mph. Trains operate on 2-minute headways in peak periods.

In 1974, PATCO carried approximately 11.2 million passengers—over 40,000 on an average weekday. Total passenger-miles amounted to slightly over 95 million. The average trip, therefore, was 8.5 miles in length and took about 13½ minutes. The average fare per passenger was 57 cents.

ATC Features

The PATCO train control system is a blend of manual and automatic operation. The design philosophy reflects two basic principles. First, the design of the system made use of technology that, at the time, represented the best of available, proven equipment. Technological innovation (and risk) at the component and subsystem level was held to a minimum. The combination and integration of elements, however, resulted in a system of highly advanced character. Second, the human operator was to be fully integrated into the system, such that he could act as a back-up to automated equipment and as the means of enhancing system performance in response to unusual conditions.

All train protection (ATP) functions are automated, accomplished by a mixture of carborne, wayside, and track equipment. Train operation (ATO) is also automatic, with two important exceptions. The single on-board operator (who is the equivalent of a motorman and a conductor) controls door opening and closing. The operator also controls train departure by pushing a start button on the cab console. Providing the doors are closed, this manual action initiates an automatic sequence of events in which the train accelerates (with automatic jerk limiting and slip-slide control), runs to the next station, decelerates, and brakes to a stop. Speed throughout the run is controlled to within ± 2

mph of command speed, and station stopping is with an accuracy of ± 50 feet.

Although train operation is normally automatic, it is also possible to operate under varying degrees of manual control (within the constraints of over-speed protection). This is often used in bad weather when the rails are slippery, especially on grades. The operator can order the train to bypass a station, without otherwise interfering with the automatic control process. The train can also be run in a completely manual mode (except for ATP). It is a procedural rule of PATCO that each train operator must run the train manually for an entire trip once a day in order to retain his operating skills. Thus, train control in PATCO can be characterized as an automatic system under supervision of an on-board operator who has the capability for manual intervention to compensate for malfunctions and to augment system performance.

In contrast, train supervision (ATS) is largely manual. PATCO uses dispatchers at a central train control board to oversee train movements, order schedule adjustments, and monitor overall system performance. Routing (switch control at interlocking) is automatic, but it can be overridden by central control. Communication with the train is by means of train phone, which uses the third rail as the conductor. Police, wayside maintenance personnel, and the Lindenwold car shop are linked with central control by a radio network.



FIGURE 41.—PATCO Train in Lindenwold Yard



FIG(JRE 42,—Outbound on Ben Franklin Bridge

PATCO stations are entirely unattended, fares being collected by an automatic vending and gate system under closed-circuit television surveillance. One or two employees at central control oversee station activities by TV, make public address announcements, and handle calls for assistance from patrons by direct-line telephones at the fare gates.

Problems and Issues

The PATCO train control system has been singularly trouble-free. The engineers of the system attribute this to the design philosophy that made use of only proven elements and conventional technology. However, it is also true that the PATCO system is relatively simple, consisting of a single line without merging points and complex interlocking. The PATCO approach was not so ambitious as that of BART, to which it is often compared. While it can be said that PATCO accomplished its objectives more fully, it should also be noted that less was attempted. Still, the PATCO system is an admirable transit system engineering achievement, and it is widely publicized as an example of prudent and effective use of automation.

There appears to be no recurring reliability and maintenance problems associated with the ATC equipment in PATCO. Certain deficiencies of design and manufacturing quality control came to light during the initial year of operation, faulty wiring connections and terminals being the most prevalent. PATCO maintenance supervisors consider these to be no more than the usual start-up and debugging difficulties, even though it did take almost a year to wring the system out. In general, car availability has been excellent throughout the 6 years of operation. The number of cars needed to provide scheduled peak-hour service has been available 99.2 percent of the time or more each year, although this requires a two-shift maintenance activity that is not common in the transit industry. ATC equipment has not contributed a disproportionate share to the overall pattern of equipment failures and maintenance time.

In the initial planning of PATCO, it was proposed to build a three-branch system in New Jersey with a common trunk line over the bridge into Philadelphia. This plan was dropped in favor of the single-line system that was eventually built. Planning is now underway to build the two additional branches (to Mount Laurel and Glassboro) and to extend the existing Lindenwold line to Waterford-



FIGURE 43.—PATCO Train Operator Monitoring ATC Equipment

Berlin. This will result in a three-pronged route plan, very much like the BART system but somewhat smaller in scale. The junction of the three branches, equivalent to the Oakland Wye in BART, is a train control engineering problem of concern to PATCO. Experience with the existing system has shown that the PATCO ATC system is adequate for a single route. However, the level of automation (especially in the area of ATS) may not be sufficient to handle three routes merging and running on a single line over the Benjamin Franklin Bridge. In order to maintain the regularity and level of service now offered, it may be necessary to install more sophisticated and highly automated equipment to control interlocking and supervise traffic movement.

SYSTEMS UNDER DEVELOPMENT

There are three rail rapid transit systems now under construction—WMATA (Washington, D.C.), MARTA (Atlanta), and MTA (Baltimore). Of these, WMATA is nearest completion; the first 4.6-mile segment is scheduled to open with limited revenue service (7 a.m. to 7 p.m.) in the spring of 1976. Ground breaking for MARTA took place in February 1975, and initial service is planned for **1978-79**. The Baltimore system is in the advanced planning stage and scheduled for completion in 1981-82.

All three systems will employ advanced train control technology, at levels of automation in the range between the PATCO and BART systems. Table 7 is a summary of the ATC features planned or

TABLE 7. Automated Features of Three Transit Systems Under Development

ATC FUNCTIONS	WMATA	MARTA	MTA
ATP			
Train in Separation	Fully automatic	Fully automatic	Fully automatic
Overspeed Protection	Fully automatic	Fully automatic	Fully automatic
Route Interlocking	Fully automatic	Fully automatic	Fully automatic
A TO			
Velocity Regulation	Fully automatic, with alternative of manual operation	Fully automatic	Fully automatic
Programmed Stopping	Fully automatic, with alternative of manual operation	Fully automatic	Fully automatic
Door Control and Train Starting	Fully automatic, controlled by local timer subject to manual override	Fully automatic	Manual
ATS			
Dispatching and Monitoring	Console and display board supported by computer	Aided, hut not directly controlled, by computer	Centralized traffic control machine and automatic dispatching units
Performance Level Control	Four levels of run time between stations, with separate control of acceleration rate, dwell time, and skip-Stop	Computer modification of speed, acceleration, and dwell time, with manual override	Six levels of speed. set in by train opf'rater in response to visual signals at stations
COMMUNICATIONS			
Operator- Passengers	One-way PA and noise monitor system	one-way PA	One-way PA
Central Control-Passengers	One-way PA	One-way via train PA	One-way via train PA
operator-Central Control	Two-way radio phone	Two-way radio phone	Two-way radio phone

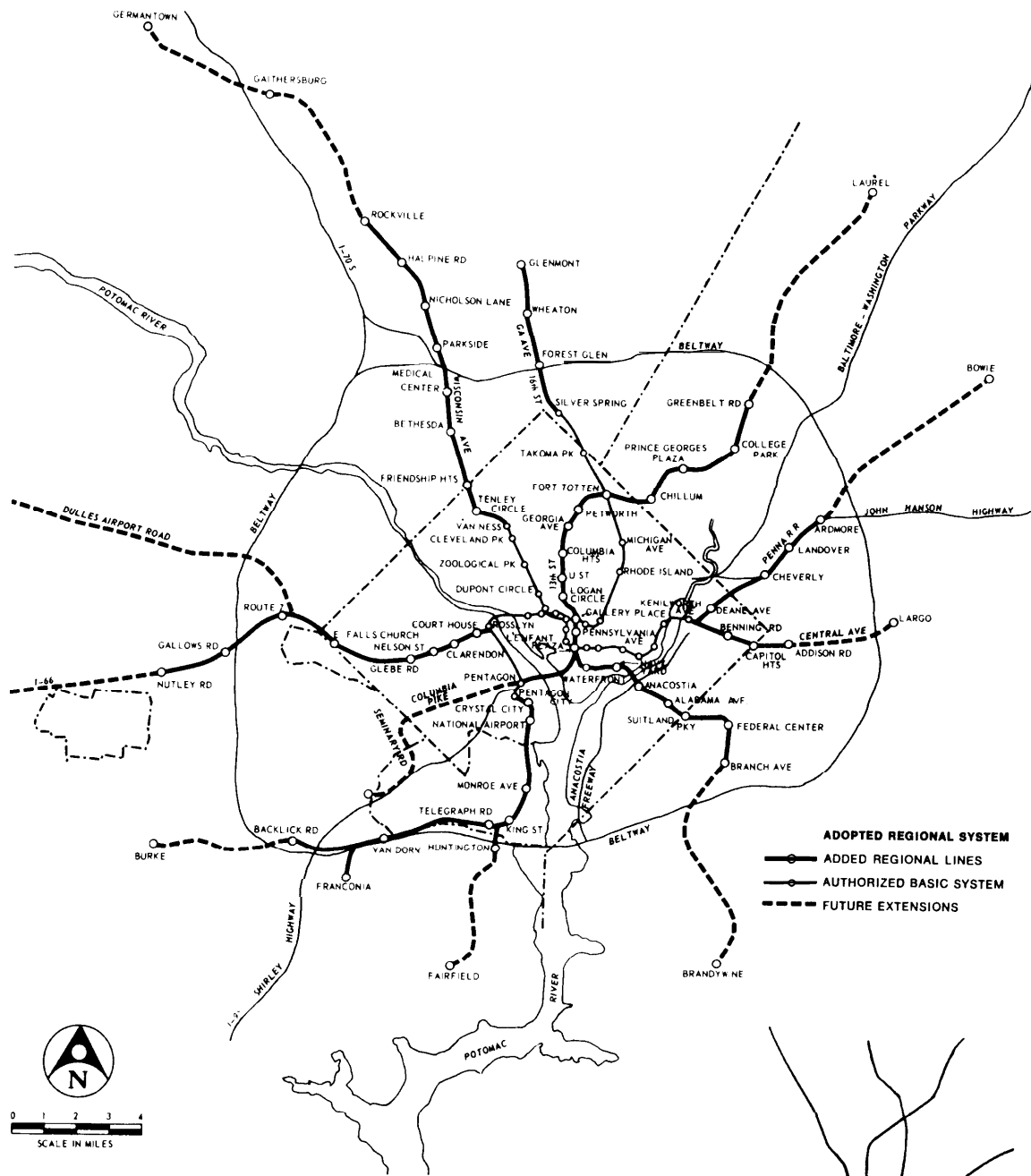
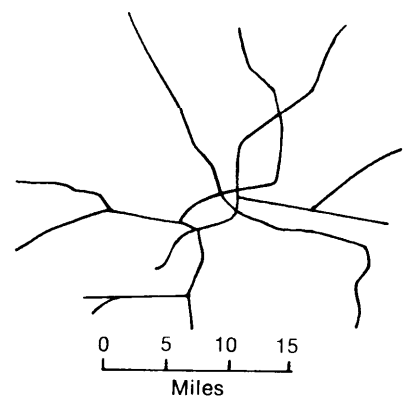

FIGURE 44.—WMATA Route Map



Schematic Route Map

proposed for each. Note that only the WMATA train control system is a firm design at this point; MARTA and MTA are tentative and subject to modification as the system evolves.

Washington Metropolitan Area Transit Authority (WMATA)

The WMATA Metro System is being built as a seven-phase project, with the last phase scheduled for completion in 1982.³⁷ At that time, WMATA will consist of 98 route-miles, serving 86 stations. There will be 47 route-miles underground, 42 miles at surface, and 9 miles on elevated structure. The WMATA system will serve the largest geographic area of any rail rapid transit system in the country (30 miles N-S and 35 miles E-W). However, the density of the network (route miles per square mile) will be rather low—about 0.09, which is the same as BART.

The WMATA fleet will be made up of 556 cars, 75 feet in length and weighing 72,000 pounds. Car capacity will be 175 (81 seated and 94 standees). The cars are designed to operate as semipermanently coupled A and B units (married pairs) to be run in consists of two to eight.

The train control system will have fully automatic train protection (ATP), including separation assurance, overspeed prevention, and route interlocking. The normal mode of train operation will be automatic (ATO), under the supervision of an on-board operator. Door closure, train starting, velocity regulation, programmed station stopping, and door opening will be automated functions. Train operation will, therefore, be similar to the ATO system of BART, except that station dwell time will be under control of a local timing device in WMATA instead of a BART-like central computer. Unlike the BART system, however, the WMATA train operator will have several methods for intervening in the automatic operating process either to augment system performance or compensate for partial failures. In this regard, the WMATA train operation system will be similar to PATCO. Train supervision (ATS) will be computer assisted and will permit either manual or automatic adjustment of performance level, station stopping, and dwell time. In general, the WMATA approach to ATC has been to employ proven, existing hardware and advanced, but not revolutionary, technology.

³⁷The first 4.8-mile segment was opened for service on March 27, 1976.

Metropolitan Atlanta Rapid Transit Authority (MARTA)

MARTA has recently begun construction of a 70-mile system of rail rapid transit integrated with high-speed busways, serving the Atlanta metropolitan area in De Kalb and Fulton Counties. The rail portion of the system will consist of approximately 50 route-miles, radiating from downtown Atlanta. The first segment (13.7 miles) is expected to be finished by 1980.

The MARTA fleet will have 200 cars, operating as married pairs in trains of up to eight. Speeds of up to 75 mph on 2-minute headways are proposed initially, with eventual reduction to 90-second headways in heavy demand corridors. The train will have one operator, who will monitor automatic train control equipment and provide limited manual back-up.

The train control system to be used in MARTA is still in the early stage of definition; a general functional design has been developed, but detailed engineering specifications had not been issued at the time this report was prepared. With regard to ATP and ATO, the MARTA system will be very much like BART.³⁸ Train protection and operation will be fully automatic, the on-board operator serving as a performance monitor. The operator will also be able to impose modifications of train operation functions. It is envisaged that the operator will act as a back-up to ATO equipment for emergency and degraded states of operation, but without the capability of running the train at full performance levels.

The supervisory functions carried out by central control will be aided extensively by a computer but will not be under direct computer control. A unique feature of the ATS system design is that it will be implemented in two stages. The first stage will provide for semiautomatic operation—computer-executed routing, dispatching, and monitoring in response to manual inputs and override by central personnel. The second stage will provide for automation of the routing and dispatching functions and will incorporate an Automatic Line Supervision (ALS) system for computer-controlled traffic regulation (dwell, performance level, schedule adjustment, reverse running, and station run-through). The implementation strategy is to use the

³⁸MARTA has engaged the same general engineering consultant, Parsons Brinkerhoff-Tudor-Bechtel, who designed the BART system.

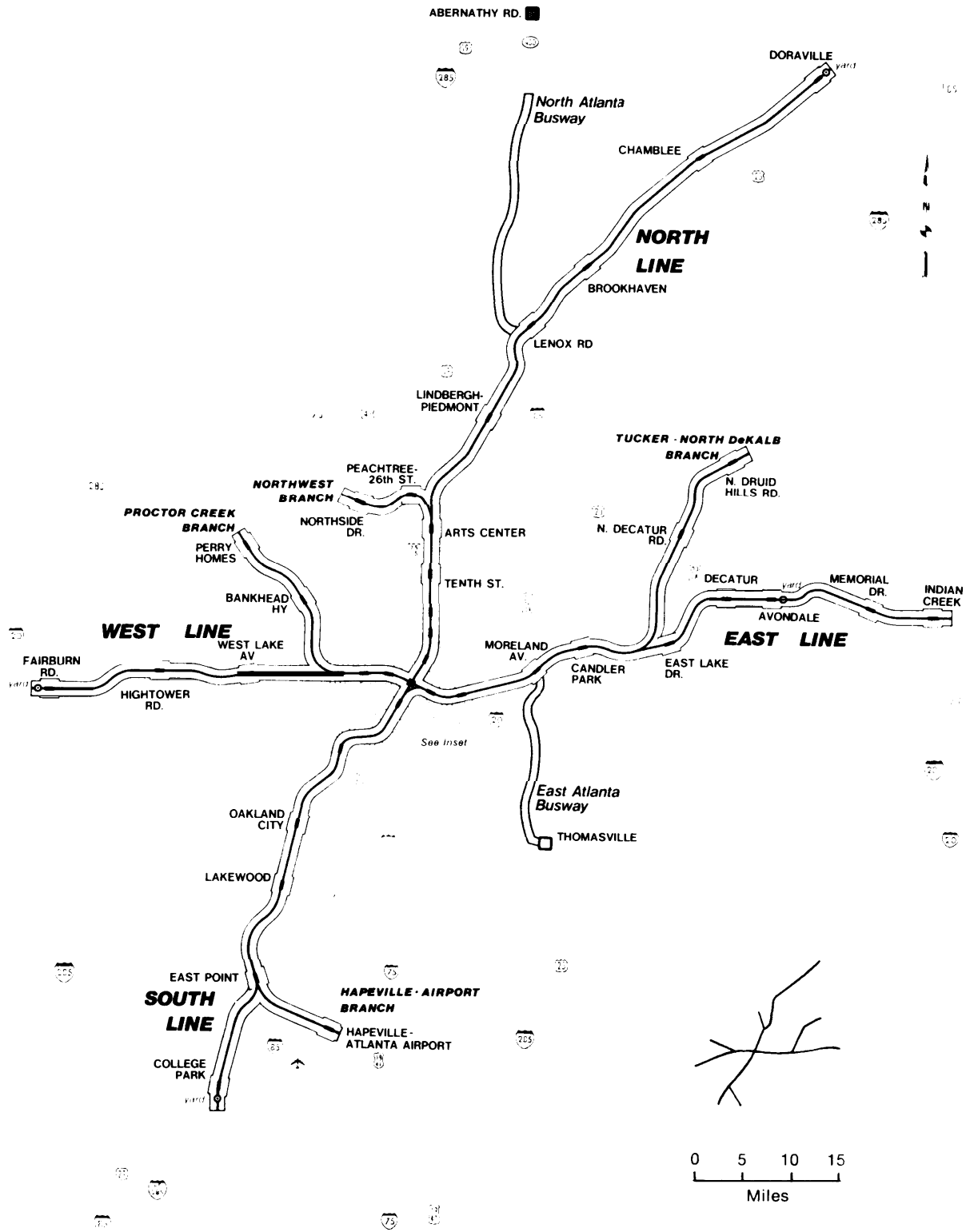

Schematic Route Map

FIGURE 45.—MARTA Route Map

Baltimore Region Rapid Transit System—Phase 1

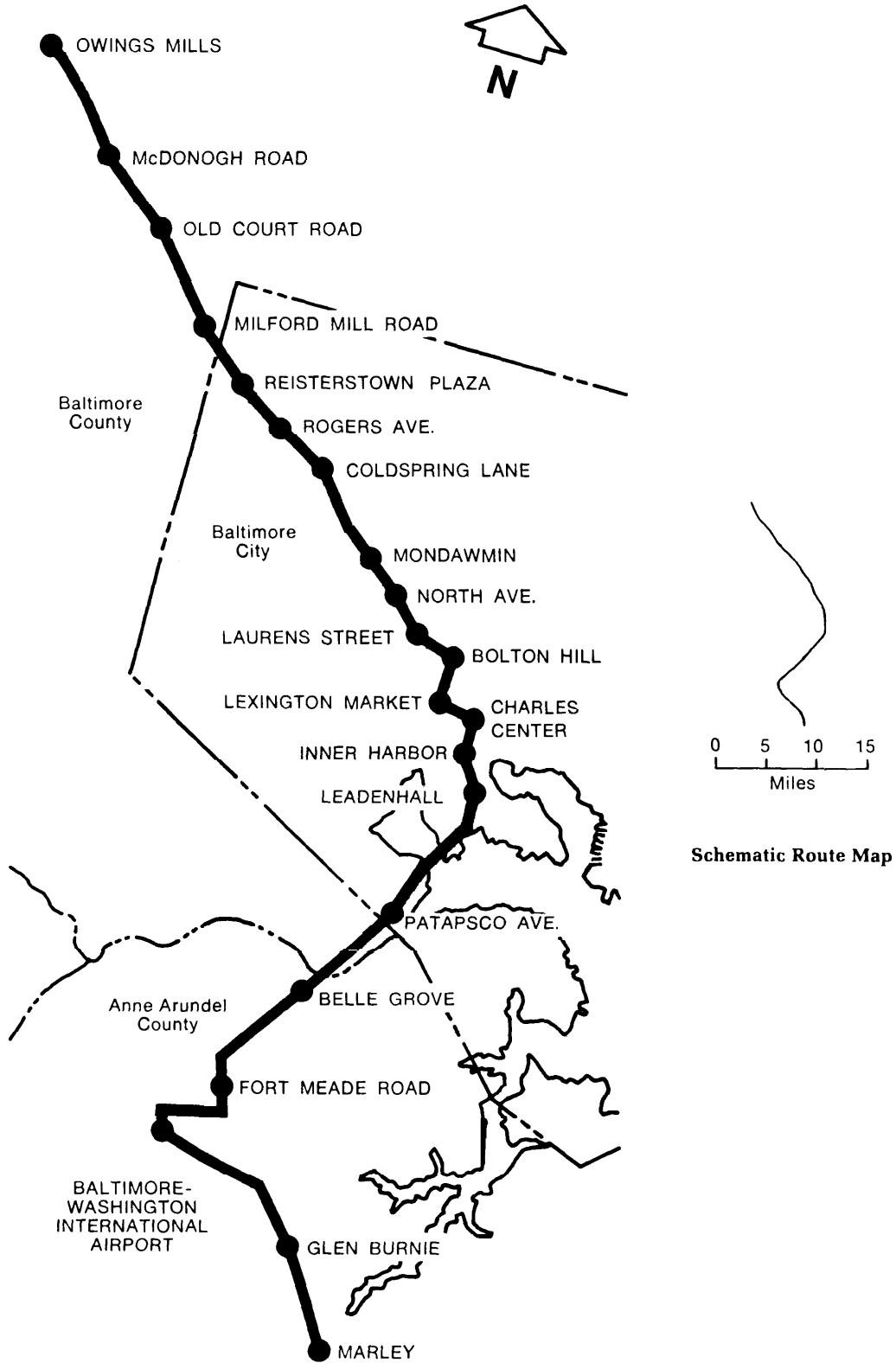

FIGURE 46.—Baltimore MTA Route Map

first, semiautomated stage as a baseline to get the system into operation and debugged and then to upgrade the central ATS complex to full automation when traffic demand increases. However, the first stage will be retained in an operable state, as a backup to automated central control for emergencies and nonnormal modes.

Mass Transit Administration of Maryland (MTA)

MTA in Baltimore is proposing to build a 28-mile rail rapid transit system extending from the northwest area of the city through downtown and terminating south of the Baltimore-Washington International Airport. So far, Federal grants have been advanced for only the northern half of the system; funding for the remainder is in question. Groundbreaking for construction of the northwest line was held in the fall of 1974.³⁹ Revenue service is scheduled to begin in 1981.

The ATC system for Baltimore has not progressed much beyond the preliminary design stage. The design concept calls for an automated

³⁹Concern over the cost of the proposed system led to a suspension of construction activity in the fall of 1975, pending a full review of costs and available sources of funding.

system similar to BART in technology but with more direct involvement in train operation by an on-board attendant. ATP will be fully automatic, as in WMATA and MARTA. Train operation (ATO) will be automatic under normal conditions, except for door control and train starting, which will be manually initiated (like PATCO). There will also be provision for train operation at full performance levels in a semiautomated cab signal mode. A novel feature of the proposed ATC system is that the on-board operator will be able to set the train speed profile to any of six levels in response to commands from central control transmitted by visual signals at the stations. Train supervision (ATS) will incorporate several automated features, but the general level of automation of central control facilities will be somewhat lower than that of WMATA or MARTA.

A noteworthy aspect of the Baltimore system design is the requirement that it be compatible with WMATA, thus making it feasible to link up the two systems at some future time if demand and metropolitan area growth patterns so dictate. At this time, however, there is some question in the minds of the designers as to whether compatibility should be limited to physical characteristics (such as clearances, platform height, car size, and traction voltage) or whether it should also include the signaling and train control system.

Chapter 5

OPERATIONAL EXPERIENCE

INTRODUCTION

The advocates of automatic train control advance three general arguments to support their case—safety, performance, and cost.

An automated system, they contend, has a higher level of safety than one in which the basic controlling element is the human operator. Automatic devices function with a consistency and repeatability that man simply cannot match. In a well-designed automatic system, hazardous events are precluded by the engineering of the system; and if an automated device should fail, there are other design features to assure that the system will revert to a condition known to be safe (the “fail-safe” principle). In short, because the behavior of machines is predictable, contingencies can be foreseen and compensated for in the design. The human operator, by contrast, is not as predictable. Man is prone to errors of judgment, inattention, fatigue, and other frailties. Furthermore, the human operator takes longer to process information and to respond, with the danger that he may not do so correctly. And so, the argument runs, the automated device should be preferred over the human because it leads to a system of greater inherent safety.

The second argument is that an automated train control system leads to superior performance. Here, the argument rests on the superiority of machine over human capabilities. Automated devices work rapidly, with greater precision, and in a manner always consistent with the objectives of the system. In the case of computers, they have a recognized advantage over man in their ability to process, store, and retrieve large amounts of information and to apply this information in the solution of complex problems. Thus, an automated train control system can move traffic at higher speeds and on closer headways; and—equally important—it can make rapid compensations and adjustments in response to changing conditions.

Automated train control systems are also asserted to be less expensive than manual systems in the long run. The initial capital costs of an automated system are admittedly higher, simply because there is more equipment to design and build. It is claimed, however, that these costs are more than offset by the reduced operating expenses of an automated system. Automated systems are cheaper to run because they have fewer operators, and it is labor costs that represent the bulk of

operating expense. Automation can also produce other savings. An automated system is claimed to be more economical in its energy use because the equipment is operated at optimal speeds and acceleration-deceleration profiles. This leads to a second form of economy: less wear and tear on the equipment due to improper operation. Finally, the optimum mode of operation brought about by automation supposedly leads to a more efficient system, making it possible to provide the same amount of passenger service with less rolling stock.

All of these assertions about the safety, performance, and cost advantages of automated systems are subject to question. The purpose here, however, is not to enter into debate. Instead, the arguments advanced for automation will be treated as hypotheses, to be tested by the empirical evidence and operating experience of transit systems where various automated control features are in use. The aim is to look at the operational record to see if there are differences among transit systems which are attributable to the level of automation. The discussion is presented as a series of propositions or issues, grouped under the general headings of safety, performance, and cost. As a corollary, an examination is also made of the role and effectiveness of man in systems with different levels of automation.

SAFETY

Safety has two aspects. There is the immediate question of passenger accidents and injuries which may be attributable to some aspect of automated train control. There is also the question of the inherent safety of the system, i.e., the extent to which the design of the system helps prevent accidents. The first question has to do with the narrower, historical concern of whether accidents have occurred, while the second deals with the larger topic of safeguards incorporated in the design against possible future accidents.

Allied to these questions is the matter of passenger security. Automated systems, with fewer transit property employees on board the trains and in the stations, might be assumed to offer the passenger less protection from assault, robbery, and other criminal actions. This point needs to be examined first because of its implications for public safety and, second, because of its influence on the decision to replace humans with automated devices in other, future, transit systems.

ISSUE O-1: TRAIN PROTECTION

Are automatic train protection (ATP) devices more effective, and inherently safer, than manual train protection methods?

The experience of the transit industry indicates clearly that ATP provides a surer method of train protection, and all new systems now under development will employ ATP in preference to manual means.

Train protection involves three basic control functions: train separation, overspeed protection, and route interlocking. In a manual system, these functions are performed by the train operator who maintains visual observation of the track ahead and runs the train in conformance with established rules and procedures. When these functions are automated, there are mechanical devices and electrical circuits at the wayside and on the train itself to assure that proper following distance is maintained (train separation), that train speed does not exceed that required for safe stopping or negotiating curves (overspeed protection), and that

conflicting moves along the lines or through switches are prevented (route interlocking).

The degree of automation and sophistication of control varies from system to system. In the simplest form, ATP is accomplished by automatic wayside block signals and mechanical trip stops that activate the emergency brakes for any train entering a block illegally or exceeding the allowed speed. At higher levels of automation, train movement is regulated continuously to maintain safe speed, following distance, and routing.

Train control engineers and transit properties universally consider ATP to be the first and basic method of preventing collisions and derailments. The newer systems built and those now under construction all incorporate fully automatic train protection mechanisms. Older properties (such as NYCTA, CTA, and MBTA) have long had wayside signals with trip stops to provide ATP, but they are installing fully automated cab signal equipment as they build new lines or modernize the existing lines. Table 8 is a summary of ATP provisions in existing and planned transit systems.

The operating experience of existing transit systems with automatic train protection devices at-

TABLE 8.—Train Protection Methods in Existing and Planned Transit Systems

TRANSIT SYSTEM	TRAIN SEPARATION	OVERSPEED PROTECTION
Existing Systems:		
BART (San Francisco)	Automatic, with advisory cab signals	Automatic, with advisory cab signals
CTA (Chicago)	Mixture, converting to cab signals ¹	Mixture of manual, trip stops with timers, and cab signals
CTS (Cleveland)	Airport Ext. automatic trip stops on rest	Airport Ext. automatic trip stops with timers on rest
Dallas-Ft. Worth Airport	Automatic	Automatic
MBTA (Boston)	Red Line Ext. automatic, trip stops on rest	Red Line Ext. automatic, manual on rest
NYCTA (New York)	Wayside signals with trip stops ²	Trip stops with timers
PATCO (Lindenwold Line)	Automatic, with advisory cab signals	Automatic, with advisory cab signals
Seattle-Tacoma Airport	Automatic	Automatic
In Planning/Construction:		
MARTA (Atlanta)	Automatic, with advisory cab signals	Automatic, with advisory cab signals
MTA (Baltimore)	Automatic, with advisory cab signals	Automatic, with advisory cab signals
WMATA (Washington, DC.)	Automatic, with advisory cab signals	Automatic, with advisory cab signals

¹Present system is a mixture of no signals, wayside signals with trip stops, and cab signals with automatic stop enforcement.

²Conversion to cab signals is planned for new lines and extensions.

tests to the general effectiveness and reliability of such equipment. PATCO, AIRTRANS, and SEATAC have never had a collision or derailment in passenger service attributable to malfunction of ATP equipment, BART has had one ATP accident, In 1972, shortly after inauguration of service, a train ran off the end of the track at the Fremont Station. The cause of the accident was traced to a faulty crystal oscillator in the carborne speed control electronics, causing the train to speed up when it should have slowed to enter the station. A redundant speed control circuit has been added to prevent recurrence of such a mishap and there have been no other accidents related to ATP in the succeeding three years of passenger service.⁴⁰

The most frequent types of accidents in a manual train protection system are the result of one train following another too closely, misjudging stopping distance, exceeding safe speed on curves, or entering improperly aligned switches. All are products of human error. ATP is specifically designed to prevent these types of accidents by interposing automatic safeguards to keep trains properly spaced and running at a safe speed on the correct route, regardless of human error or inattention. The safety record of rail rapid transit owes much to the effectiveness of such automatic protective devices which apply the fail-safe principle to assure that the train

⁴⁰The collision between a BART test train and a maintenance vehicle in January 1975 occurred at night on a weekend, when the system was shut down. The cause was found to be human error and improper operating procedure by the maintenance vehicle driver and the train supervisor in central control.

will maintain a known safe condition in the event an automated element malfunctions.

The operating experience of the Chicago Transit Authority over the past 10 years offers an instructive example of the safety advantages of automatic over manual train protection methods. The case of CTA is singled out because it is typical of the operating experience that has led existing transit systems to conclude that ATP is a necessity.

CTA can be characterized as a mixed system. Ten years ago CTA had wayside signals with trip stops on some lines or parts of lines and no signal protection on the remainder. In the unsignaled portion of the system the safety of train operation depended solely on the alertness of the motorman and compliance with operating rules designed to prevent collisions and derailments, As the new Dan Ryan and Kennedy extensions were built, they were equipped with cab signals and automatic overspeed protection, In some cases, however, these new lines merged with older portions of the system having either no signals or wayside signals with trip stops. Beginning in 1965, CTA undertook a modernization program, part of which involved installation of cab signaling to protect segments of trackage formerly not signaled. This work is now nearing completion, but in late 1975 the system remained a mixture of wayside and cab signals, with a few sections still not signaled at all. A train operator on the North-South line or the West-Northwest line, for example, runs the train under all three forms of train protection at one time or another during the course of a single trip.



FIGURE 47.—Interlocking Control Tower for Train Protection

The record of collisions and derailments from 1965 to 1974 illustrates the consequences of operating under incomplete signal protection or by manual and procedural methods alone. There were 35 collisions and 52 derailments in this period, an average of about one accident every 6 weeks. Most were minor accidents, but there were two fatalities—both in a 1966 derailment produced by equipment falling off the train. An analysis of accident causes (Table 9) shows that human error was a contributing factor in every collision and in almost two-thirds of the derailments.⁴¹ Collisions typically resulted from the train operator misjudging stopping distance or following too closely. Derailments were most often caused by overspeed on curves or by the operator entering an improperly aligned switch while proceeding on hand signals.

The record also shows that cab-signaled ATP was a contributing factor in only one accident. In this case, the motorman was operating in cab-signal territory for the first time on the first day of operation of a newly extended line. The cab signaling unit had not cut in as the train passed from unsignaled into cab-signaled territory, and not noticing this, the motorman failed to operate accordingly.⁴² The train rounded a curve in the subway and hit a standing train ahead because the motorman was unable to stop in time. CTA determined the cause of the accident to be a combination of cab signal equipment failure and human error. CTA has taken measures to prevent recurrence by tighter instructions, modification of procedures for entering cab signal territory, and more conservative turn-on and

testing procedures when initiating service with new cab signal equipment.

Two points emerge from this analysis. First, ATP is superior to manual methods of train protection because it safeguards against most types of human error, which cause the majority of collisions and derailments.⁴³ Second, a mixture of signaled and unsignaled lines requires two distinctly different (and perhaps incompatible) modes of response from the train operator, with the attendant risk of confusion between the two at a critical moment.⁴⁴ Both these points were recognized by CTA, which cited prevention of accidents resulting from human error and attainment of a uniform level of signal protection for the whole system as prime reasons for undertaking the cab signal conversion program.

⁴³No automatic system is foolproof. After the collision of trains in the Mexico City transit system on October 20, 1975, in which 27 people were killed, the investigation disclosed that the train operator (in violation of established rules) had disconnected ATP equipment that would normally have stopped the train.

⁴⁴In a different way, the recent collision in Boston illustrates the risk associated with mixing manual and automatic methods of train protection. On August 1, 1975, in the tunnel between the Charles Street and Park Street stations, an MBTA Red Line train was struck from the rear by a following train. About 2 minutes later, the second train was hit by a third entering the tunnel. There were no fatalities, but 130 were reported injured. This part of the Red Line is protected by wayside signals and trip stops. However, about an hour before the accident, a trip stop had malfunctioned; and trains were being moved past the trip stop under manual rules requiring that the motorman proceed slowly and be prepared to stop within line-of-sight distance. The exact cause of the accident has not been officially determined, but it seems to have resulted not from a failure of the ATP system but from a lapse in the manual back-up procedure. This suggests that a transit system becomes vulnerable to human error at a time when the normal automatic protection methods are inoperative and train operators must revert to unaccustomed manual and procedural methods.

⁴¹Apart from human error, the greatest contributing cause in derailments was car defects (16 of 52 cases).

⁴²CTA procedures prescribe that, in this circumstance, the motorman should continue to operate under manual rules and be prepared to stop within line-of-sight distance,

TABLE 9.—Analysis of CTA Accident Record, 1965–74

TYPE OF ACCIDENT	TOTAL	CONTRIBUTING FACTORS*						
		Car Defect	Track Defect	Weather	Wayside Signals	Cab Signals	Human Error	Vandals
Collision	35	5	0	2	1	1	35	3
Derailment	52	16	4	0	6	0	31	1

● Some accidents had more than one contributing factor.

ISSUE O-2: TRAIN OPERATION

Does automatic train operation (ATO) have an influence on safety, as measured by the type and number of passenger injuries?

Based on analysis of the records of four representative transit systems, there is no difference in the injury rates between manual and automatic modes of train operation. Passenger inexperience is more of a causal factor than the mode of operation.

There are two types of passenger accidents that might be influenced by automatic train operation—falls on board due to train motion and door closure accidents. If either automatic or manual train operation resulted in a characteristically smoother ride, the frequency of passenger falls and injuries due to lurching of the train during starts, stops, and running on curves would be expected to be lower. Automatic door operation might be expected to produce more instances of passengers being struck or caught by closing doors because there is no train attendant to regulate door operation for the tardy or unwary passenger,

An analysis of accident records for four representative transit systems (NYCTA, CTA, PATCO, and BART) does not substantiate either of these hypotheses. The frequency of train motion accidents in the NYCTA and CTA systems, where trains are run manually by a motorman, is essentially the same as in PATCO and BART, where train operation is automatic under the supervision of an operator in the control cab. Similarly, the rate of door

closure accidents does not differ regardless of whether doors are operated manually (either by a conductor or train operator) or automatically. (See table 10.)

A word of caution must be given regarding transit passenger injury statistics. There are no common definitions of injury (or its causes) employed by the four systems considered here or by the transit industry as a whole. For this reason, the injury rates for various kinds of accidents are not precisely comparable from system to system and should be taken only as general indications of the safety record. It should also be noted that the figures given are for claimed injuries, i.e., passenger reports of injury at the time of the accident without regard to severity or substantiation by medical examination. The number of actual injuries (e.g., those requiring medical treatment or those that lead to a later claim for compensation) is considerably lower, perhaps by as much as half.

It must also be emphasized that passenger injuries due to any aspect of train operation are events of extremely low frequency—literally about one in a million. By far, the greater proportion of injuries to transit system patrons (60–80 percent of all accidents) occurs in stations. Falls on stairways, for example, typically account for more injuries than all types of train accidents combined. Table 11, a summary of passenger accident statistics in four systems, illustrates the general nature of the rail rapid transit safety record.

With regard to fatalities, rail rapid transit is one of the safest of all modes of transportation. In 1973, 15 people lost their lives in rail rapid transit acci-

TABLE 10.—Passenger Injuries Due to Train Operation

TRANSIT SYSTEM	TRAIN MOTION		DOOR CLOSURE	
	Mode of Operation	Rate ¹	Mode of Operation	Rate ¹
BART (1974)	Automatic	1.0	Automatic	1.6
CTA (1973)	Manual	0.7	Conductor	1.3
NYCTA (1973/74)	Manual	0.4	Conductor	0.4
PATCO (1973)	Automatic	0.6	Train Operator	1.4

¹ Reported in injuries per million passengers.

² The BART figure is for all on-board accidents, which include falls due to train motion and other types of mishaps. The rate of accidents due to train motion alone is therefore somewhat lower, probably about the same as the other systems.



FIGURE 48.-CTA Passengers Alighting at Belmont Station

TABLE II.—Passenger Accident Summary

TYPE OF INJURY	BART (1972-74)		CTA (1969-73)		PATCO (1969-73)		NYCTA (1973-74)	
	Rate ¹	Percent	Rate ¹	Percent	Rate ¹	Percent	Rate ¹	Percent
STATIONS								
Falls on Stairs.....	24.1	61	3.3	24	3.1	21	3.4	61
Gates/Turnstiles.....	NA	² —	0.2	1	2.0	14	NA	² —
All Other.....	8.5	21	7.2	52	4.4	30	NA	² —
TRAINS								
Boarding/Alighting.....	1.3	3	0.7	5	0.7	5	0.4	7
Doors.....	3.8	10	1.2	9	1.8	12	0.4	7
Train Motion.....	1.4	4	0.8	6	0.9	6	0.4	7
All Other.....	0.3	1	0.4	3	1.6	11	1.0	18
TOTAL.....	39.4		13.8		14.5		5.6	

¹Reported injuries per 1 million passengers.

²Not available.

dents⁴⁵--a rate of 0.0075 fatalities per million passengers. Fatality data for other modes of transportation during 1973 are shown in table 12.

Rail rapid transit ranks among the safest of transportation modes in terms of fatality rate, as well as in absolute numbers. In the period 1970-72, the rate was 0.83 deaths per billion passenger-miles in rail rapid transit,⁴⁶ as compared to 0.69 in transit

buses, 1.03 in scheduled air carriers, 2.6 in passenger railroads, 20.8 in private motor vehicles, and 21.1 in elevators (Battelle, 1975). To set the rail rapid transit fatality rate in additional perspective, the figure of 0.83 per billion passenger-miles is the equivalent of a six-car train, carrying a total of 900 passengers, traveling over 53 times around the earth before a death occurs.

Of the passenger deaths in rail rapid transit, about 80 percent are the result of falling while walking between cars on a train in motion. The re-

⁴⁵There were also 94 deaths due to suicide jumps from station platforms or trespassing on the right-of-way.

⁴⁶Excludes suicides and trespasser deaths.

TABLE 12.—Fatalities in the United States by Transportation Mode During 1973

TRANSPORTATION MODE	NUMBER OF DEATHS
Private Auto	33,500
Trucks	5,700
Motorcycle/Motor Bike	3,130
Marine, recreational	1,754
Marine, commercial	320
Aviation, private	1,340
Aviation, commercial	227
Grade Crossing	1,215
All Railroads	698
Taxicabs	170
Buses	170
Pipeline	70
Rail Rapid Transit, passengers	15
Rail Rapid Transit, suicides and trespassers	94

SOURCES: New York City Council on Economic Environment, 1974; and National Safety Council, 1974.

mainder are produced by a variety of causes, no one of which accounts for a significant proportion. Thus, train control (either manual or automated) is a contributory factor in only a tiny fraction of rail rapid transit fatalities—probably not more than one death in the approximately 2 billion people carried

each year. During the 5-year period studied for CTA and PATCO and during the 3 years of BART operation, there have been no passenger deaths on trains or station platforms as a result of transit operations. In NYCTA between July 1969 and October 1973, there were five deaths related to train operation (three caught in doors and two killed in a collision).

Examination of the accident records for newer transit systems reveals that the patrons' experience with rail rapid transit seems to be more of a contributing factor than the difference between manual and automated modes of operation. Accident rates in the first year of operation of a new transit system to be three or four times higher than for older and established systems or for the same system after the public has gained riding experience. Figure 49 shows the history of train motion accidents for the PATCO Lindenwold Line and the Dan Ryan extension of the CTA West-South Line, both opened for service in 1969. Comparable data for the first 3 years of BART operation are also shown. PATCO and BART have automated train operation. Trains are operated manually with cab signals on the Dan Ryan Line. For comparison, the train motion accident rates for CTA as a whole are shown for the 5-year period 1969–73. Here, the rate for a presuma-

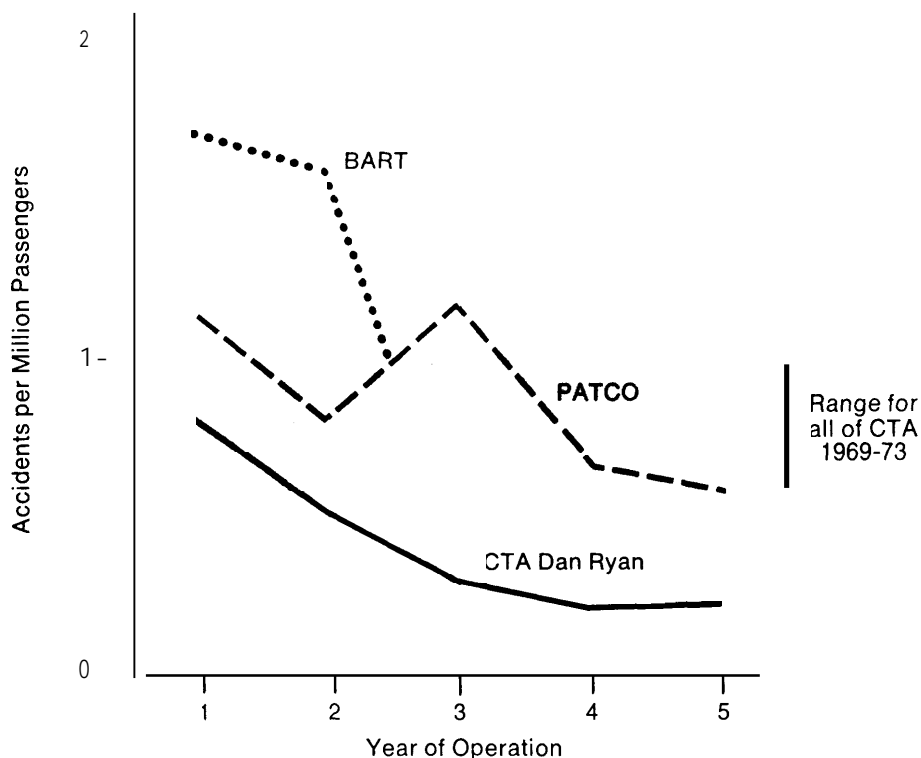

FIGURE 49.—History of Train Motion Accidents

bly experienced riding public is steady between 0.6 and 1.0 per million passengers, a range which includes the latest figures for PATCO and BART.

A similar learning phenomenon appears in the pattern of door closure accident rates. The rate in BART for the first year (1972–73) was 5.5 per million, but it declined to 4.3 and then 1.6 in the next year and a half. In PATCO, the decline was from 2.7 to 1.4 over a 4-year period (1970–73). In CTA as a whole, it fluctuated in the narrow range of 1.0 to 1.4. Since car door operation is automatic in BART and manual in PATCO and CTA, automation does not appear to have anything to do with the accident rate. All three systems seem to be approaching, or to have reached, a common floor of about 1.0 to 1.5 per million passengers.

ISSUE O-3: DESIGN SAFETY

With respect to design and engineering, are ATC systems safe?

On theoretical grounds, ATC is at least as safe as manual control, and probably safer. However, there is insufficient evidence from actual transit operations (except in the area of ATP) to evaluate safety empirically. There is also some difference of opinion in the transit industry on how to assure the safety of a design.

The rail rapid transit industry is extremely conscious of safety, which is customarily defined as “freedom from fatalities or injuries resulting from system operation.” Safety-consciousness is reflected not only in the approach to transit operations but also in the design and engineering of track, wayside equipment, and rolling stock. All components judged to be critical to safety (“vital” components, in transit engineering parlance) are designed according to the fail-safe principle. Stated simply, fail-safe is “a characteristic of a system which ensures that any malfunction affecting safety will cause the system to revert to a state that is generally known to be safe”⁴⁷ (NTSB, 1973).

⁴⁷The exact interpretation of the fail-safe principle is difficult under some conditions, especially where it may lead to stoppage of a train in hazardous circumstances, e.g., a tunnel fire. A discussion of this point is presented later, beginning on page 86.

The fail-safe principle appears to be applied as rigorously to the design of ATC as to other transit system components, and probably even more so because of the concern engendered by removing the human operator from direct involvement in train control functions. Therefore, at the design level at least, there is no reason to conclude that automated train control systems are not as safe as manual systems. They may even be safer because possible hazards due to human error and variability have been eliminated by substitution of machine components.

But has this substitution merely replaced one form of hazard with another, perhaps to the general detriment of system safety? This question goes to the heart of the automation issue, but it is largely unanswerable at present for two reasons. First, there is very little empirical evidence from automated systems by which to judge safety historically, except for the case of ATP.⁴⁸ Second, there are no generally acceptable criteria by which to evaluate safety from a theoretical viewpoint, especially when comparing dissimilar systems.

At present, there are only two operational rail rapid transit systems in the United States with a substantial degree of automation for functions other than ATP. PATCO, opened in 1969, has ATP and ATO. However, PATCO is a system consisting of only one line, and therefore neither representative of a large urban mass transit system nor a true test of automation technology. On the other hand, the safety features of PATCO are impressive, reflecting both safety-consciousness in design and awareness of the realities of rapid transit operation. The safety record attained by PATCO is excellent and attests to the basic safety of ATO, at least at that level of automation and in a system of that complexity.

The San Francisco BART system is more highly automated than PATCO, incorporating ATS as well as ATP and ATO, but the system is relatively new and still undergoing start-up problems. Testing and evaluation prior to full operational certification are still being conducted by the California Public Utilities Commission. However, even before

⁴⁸The traditional view of transit engineers is that the safety of a transit system is wholly assured by train protection functions and that ATO and ATS play no part in safety. This is correct if safety is defined simply as the prevention of collisions and derailments. However, if safety is defined more broadly as the freedom from injuries or fatalities resulting from system operation (the view taken here), then the safety of ATO and ATS equipment becomes highly germane.

revenue operations began in late 1972, BART was the subject of intense public controversy over the safety of ATC design, and the debate continues even now. The concern over ATC in the transit industry and in State and Federal Government bodies seems to have been engendered by the BART experience. Nevertheless, it appears that the difficulties besetting BART result more from specific engineering defects and management problems than from any inherent shortcoming of ATC technology itself.

The application of automation technology in rail rapid transit is not, of course, limited to PATCO and BART. There are individual lines within larger systems (e.g., the CTA Dan Ryan extension and the Quincy extension of the MBTA Red Line), but the extent of automation is not so great as in PATCO and BART, consisting only of ATP and machine-aided train operation by means of cab signaling. Also, the results in CTA and MBTA are hard to distinguish because of the merger of the cab-signaled portions into lines with other forms of signaling and train control.

Outside of rail rapid transit there are some nine automated guideway transit (AGT) systems⁴⁹ in the U. S., such as the Dallas/Fort Worth (AIRTRANS) and the Seattle-Tacoma (SEA-TAC) airport systems, operating without a human controller on board. The adequacy of ATC with respect to design safety has been generally established in these systems, which employ a technology derived from rail rapid transit. However, there is some question whether this experience is transferable back to the parent rail rapid transit technology. Speeds are generally lower in AGT; vehicles are smaller; and the lines are fewer, with less complex interlocking.

Thus, the pool of operational experience with ATC in rail rapid transit is rather small, consisting of 6 years of relevant data from a simple one-line system (PATCO) and 3 years from a complex system (BART). There is also fragmentary evidence from the CTA Dan Ryan and MBTA Red lines, where the level of automation is lower and not characteristic of the system as a whole. The data from AGT may or may not be applicable to rail

⁴⁹Automated Guide way Transit (ACT) is a general designation for transportation systems operating relatively small, unmanned vehicles+ ither singly or in trains-on fixed guideways along an exclusive right-of-way. See the OTA report, Automated Guideway Transit (Report No. OTA-T-8), June 1975, for an assessment of this type of transit technology.

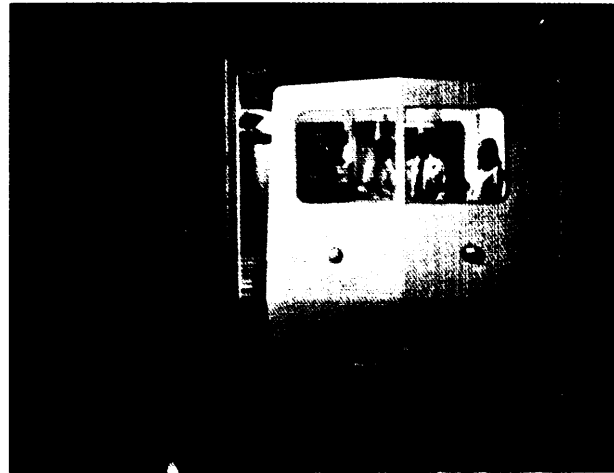

FIGURE 50-Unmanned Train at Seattle-Tacoma Airport

rapid transit because of certain basic differences of scale and complexity.

The opinion of transit system managers with regard to the safety of ATC is significant. A recent survey of transit system safety problems, conducted under UMTA sponsorship, did not identify ATC as an area of concern. Priority action was recommended for several safety problems; but train control systems and automation were not mentioned, even though these topics were listed in the survey form circulated among transit system operating authorities (Transit Development Corporation, 1975).

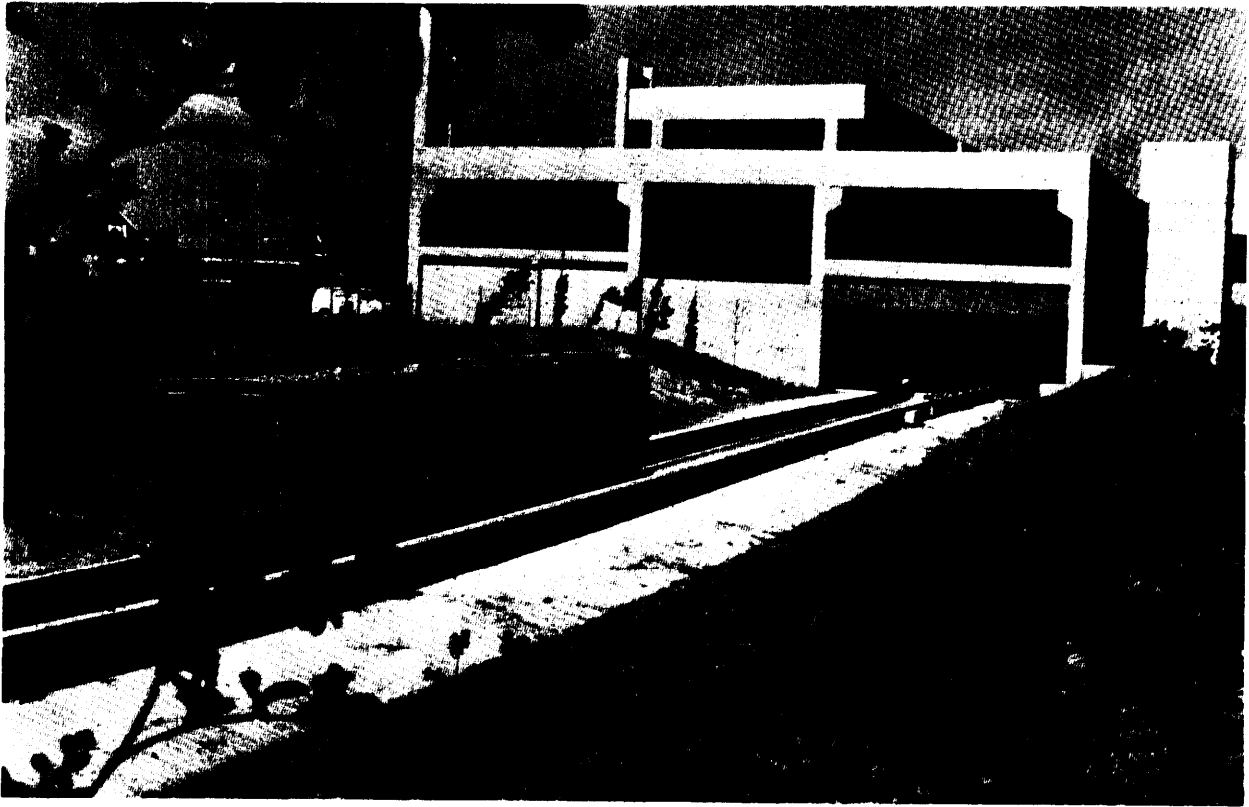

FIGURE 51.—Fully Automated AIRTRANS Train

The matter of available data on operating experience aside, there remain more fundamental questions of methodology and criteria. How is safety to be measured, either empirically and theoretically? How safe is safe enough? What is meant by safety? Is ATC Safety equitable with the train protection function, or are there safety implications in ATO and ATS? Not all these questions have answers generally accepted by experts in the field of safety and train control engineering.

A study of ATC safety conducted by the DOT Transportation System Center (1974) reached the conclusion that it is "literally impossible to achieve fail-safe design in a large complex control system having many interacting elements and functions." No matter how carefully designed and tested a system may be, there will always be certain combinations of component failure or operational conditions that cannot be wholly compensated for. The probability of such events, although infinitesimally small (1×10^{-6} or less), represent potential safety hazards that must be dealt with. In other words, no

system as large and complex as a rail rapid transit system can be made perfectly safe. Some risk must always be taken.

And so, on theoretical grounds, the question of ATC safety reduces to a matter of probabilities and acceptable levels of confidence. At the present time, there is some disagreement within the transit industry and among Federal and State regulatory agencies as to how these probabilities are to be estimated or what measure of risk is tolerable.⁵⁰

The traditional design approach followed in the transit industry for ATP has been the fail-safe concept, where the essential concern is the immediate or short-range response to protect the system from the consequences of component or human failure. Customarily, this protection is achieved by initiating a shutdown or reversion to a lower level of performance (e.g., decreased speed, greater headways,

⁵⁰Transit system professionals have also taken issue with the general approach and some of the conclusions of the TSC study.

longer station dwell time). The difficulty with this approach is that most modern transit systems operate on very short headways. Thus, if a failure occurs, it is not simply a matter of stopping one train. The effect reverberates through the entire system, or a large part of it, requiring that many other trains be stopped or slowed until the failure can be corrected. Such sudden and unexpected changes in the operating mode of the system can produce a risk situation that pervades far beyond the point of failure and persists long after the failure has been corrected. Thus, application of the fail-safe principle may produce a response which is safe for the immediate and local circumstances but which also produces longer-term and more far-reaching consequences for the general safety of the system.⁵¹ (NTSB, 1973)

As a supplement to the fail-safe approach, NTSB has advanced the concept of total system safety. The first step of this approach is to select system goals, e.g., prevention of collisions and derailments. The system is then analyzed with respect to these goals to determine where the system could fail and allow a collision or derailment to happen. The analysis permits construction of a "fault tree," which includes not just single component failures, but also multiple failures and environmental interactions, making it possible to identify those parts of the system which are critical to safety and to trace out the paths where failure must be prevented from compromising any of the system safety goals. This, in turn, shows the designer the parts of the system which must be provided with redundant components, functionally equivalent mechanisms, self-checking circuits, or inhibitory devices. Through application of statistical techniques, it is also possible to evaluate the likelihood of failures and adverse circumstances and thereby place the assessment of risks on a quantitative basis. (NTSB, 1973; Battelle, 1975)

The approach suggested by NTSB recognizes that the safety of the system as a whole is not equivalent to the safety of its parts and offers an alternative method to assess interactive and combinatorial effects of component failure. The NTSB approach also offers a way to identify hazards on a system-wide basis and to make explicit the level of risk imposed by each. However, both the methodology and

⁵¹Some members of the transit industry have disputed these conclusions on the grounds that NTSB has misinterpreted the fail-safe principle and that the concept of pervading risk is appropriate to aviation but not to a transit system.

validity of this approach have been challenged by transit system engineers. Some maintain that the fail-safe principle—correctly applied—is adequate and proven by experience and that there is no need for recourse to a total system safety concept. Others contend that the NTSB approach offers nothing new and that it is only a restatement of the safety analysis methodology customarily applied as part of the fail-safe approach.

In summary, the safety of ATC design (except for ATP) has not been conclusively determined. With respect to the theoretical safety of ATC, adequate precautions appear to be taken in the design process to assure that automated devices result in a level of safety at least as high as that conventionally attainable with manual means of train control. The absolute safety of ATC devices cannot be ascertained by any safety methodology, criteria, or design philosophy currently employed in the transit industry. Empirically based judgments about the safety of ATO and ATS can be only tentative at present because data are limited to a few systems for only relatively short periods. With respect to ATP, the available evidence indicates that automatic methods are safer than manual train protection. In practical terms, accidents due to defects of train control (either manual or automatic) are events of very low probability—estimated here to be on the order of one injury per million passengers and one fatality per billion passengers, rates which are among the lowest of all modes of transportation.

ISSUE O-4: PASSENGER SECURITY

Does reduction in the number of on-board personnel, brought about **through** ATC, have an adverse effect on passenger security from crime?

There is no evidence to suggest that passenger security on trains is affected by reducing the size of the train crew.

The security of passengers from criminal acts in stations and on trains is a matter of serious concern to rail rapid transit operating authorities. It has been conjectured that automation, because it tends to reduce the number of transit property employees on trains and in stations, might have an adverse effect on passenger security. Passengers, especially on long trains with a crew of only one, might be more vulnerable to assault, robbery, and other criminal

acts because the only transit employee who could render assistance is located at the front end of the train, often in an isolated compartment, giving full time and attention to train operation or supervision of ATC equipment.

This line of reasoning has been advanced primarily as an argument against reducing the number of on-board employees as a result of automating train control functions. The argument also bears indirectly on the justification for ATC itself. If personnel in addition to the train operator (the so-called second and third men) are to be kept on board anyway for security purposes, then they could assist in train operation by performing manually such functions as door operation, train announcements, and equipment monitoring.

The managers of operating transit systems tend to the belief that personnel on board the train have a favorable influence on security, both in protecting passengers from robbery and assault and in deterring vandalism to the train itself. Agencies planning new systems generally hold the same view, and those planning to have only one or no on-board attendant intend to compensate by having more station personnel and roving security employees,

The operating transit systems have greatly varying approaches to passenger protection and train policing. NYCTA maintains a very large transit police force (5,100, the eighth largest police force in the country), with patrolmen posted in stations and on the trains themselves during certain hours and in high crime areas. PATCO has a rather small transit police force (20 men), which includes a dog unit that patrols the property during the rush and base periods and rides the train during owl service. BART also has its own police force; but considering the size of the property, the force is small (99 members, of which 63 are in patrolling platoons). In contrast, CTA has no transit police force as such; passenger security protection is provided by the police departments of the municipalities served.

There is, however, no firm statistical evidence to support the contention that presence of operating personnel or police on the train does, in fact, promote passenger security. Crime statistics for four transit systems (BART, CTA, PATCO, and NYCTA) are presented in table 13. Data for other systems are not available, but anecdotal information suggests that the rates are roughly comparable to those shown.

Caution should be observed in interpreting these data. The four transit systems shown here differ greatly in such characteristics as hours of operation, security measures, and types of communities served. There are also slightly differing definitions among the four as to what constitutes robbery or assault. For example, some include purse snatching in the category of robbery, while others do not. Some list sex offenses separately; some combine such crimes with other forms of assault. An attempt has been made to reduce the statistics presented here to a common base, but some distortions undoubtedly remain. Therefore, the rates given in table 13 should be taken only as an indication of the rough dimension of the problem and should not be considered to show the relative degree of passenger security in the four systems.

TABLE 13.—Passenger Assaults and Robberies for Selected Transit Systems

SYSTEM	ASSAULT/ROBBERY RATE (per million passengers)
BART (1973-74)	2.96
CTA (1969-73)	1.44
NYCTA (1973/74)*	3.49
PATCO (1969-73)	0.24

* July 1973 to June 1974.

While only limited conclusions can be drawn from this sample of data, there does not seem to be any clear relationship between crime rates and the number of operating personnel on the trains. For example, PATCO with only one operator on the train and unmanned stations has a rate that is an order of magnitude lower than NYCTA, where there are two men on board and police actively patrol trains and stations. Also, the rates in BART and NYCTA do not appear to differ substantially even though the two systems are vastly different in terms of automation and the level of train and station manning.

The dominant factors influencing security seem to be the size of the city and the sociological characteristics of the areas served. It should also be observed that, if ATC has any influence at all, it is likely to be small since the preponderance of crime in rapid transit systems (75-80 percent) does not



FIGURE 52.—Approach to Brightly Lighted Station

take place on trains, but in and near stations. A study conducted by the American Transit Association (1973) concluded that station security was by far the more critical problem and that station crime was concentrated in neighborhoods of generally high crime, usually near the residence of the criminals. Anecdotal evidence from transit properties interviewed also indicates that the areas of greatest concern are stations, access ways, and parking lots

and that patrols are concentrated there. In light of this, it is perhaps significant that most transit-properties list all assault and robbery statistics under the general heading of station incidents.

As a final comment, a distinction must be made between the real (i.e., statistically measurable) security of passengers and their perception of security while using a transit system. In the area of



FIGURE 53.—Lonely Station at Off-Peak Hour

perceived security, most transit operators and planning agencies agree that the on-board employee plays a useful and reassuring role. Communications of any and all forms are also believed to be useful for enhancing perceived (and real) security of patrons. Two-way communication with passengers is regarded as mandatory for systems with unattended vehicles. Surveillance of train interiors by closed-circuit television is technically feasible, but most properties consider the cost of purchasing and operating the equipment to be prohibitive in comparison to the potential benefits.

Data on the perceptions of passengers themselves do not exist in any meaningful quantity. In one of the few studies made of passenger attitudes, a telephone survey of 1,586 bus and rail rapid transit patrons in Chicago, it was found that passengers would derive the greatest sense of security from the presence of a police officer on the train or platform and from the knowledge that help was available quickly from station personnel or the police. Few respondents (8 percent) mentioned the presence of a conductor or motorman as a reassuring factor. This survey also found that CTA patrons tended to regard subway stations and elevated platforms as more dangerous than the trains themselves. (ATA, 1973)

PERFORMANCE

The operational characteristics of ATC can affect the general performance of a transit system in several ways. Some may be qualitative; others quantitative. Some may directly affect transit patrons and be perceived by them as benefits. Other performance characteristics may be of concern primarily to the operating authority and go largely unnoticed by the riding public. Those selected for examination here are the more tangible and measurable aspects of system performance, where differences between manual and automated forms of train control might be manifested as benefits for either the transit patron or the operating authority. They are:

Ride Quality—the smoothness and comfort of the ride, expressed in terms of speed and its derivatives (acceleration and jerk);

Level of Service—the convenience and dependability of the transit system, measured as headway, trip time, available seating, and adherence to schedule;

Availability—the ability of the system to sustain the required level of daily service, as indicated by the reliability and maintainability of equipment.

As in the preceding discussion of safety, the performance of ATC systems is treated as a series of issues, with operational experience from various cities presented in tabular format to substantiate the conclusions. This method of presentation tends to invite comparisons among transit systems; and it is intended that the reader do so, but only within the limits set forth in the discussion of the issue. Some differences are more apparent than real. They arise either from different definitions and recordkeeping methods or from differences among systems that have nothing to do with train control (e.g., track geometry, right-of-way conditions, station spacing, environmental factors, age of equipment, and so on). An effort has been made to reduce all data to a common base and to use standardized terms, but there still remains a need for caution in making direct comparisons across systems.

ISSUE O-5: RIDE QUALITY

What effects does automatic train operation (ATO) have on ride quality and comfort?

ATO systems provide a ride quality equal to that of manual modes of operation. Some consider ATO systems superior in that the ride quality is more uniform.

Ride quality is a general term referring to the smoothness and comfort of train motion as perceived by the passenger. It is measured in terms of the acceleration and deceleration characteristics of the vehicle while running at speed and during arrival and departure from stations. Ride quality is influenced by many factors—propulsion and braking system characteristics, vehicle suspension, track geometry, condition of the right-of-way, wheel-rail adhesion, signal system design, and speed regulation technique. Of these, only the last two fall within the province of the train control system, and they usually do not have a major influence on ride quality. Vehicle and track characteristics are by far the dominant factors. However, the train control system can play a part in enhancing ride quality or in compensating for adverse effects produced by other factors.

In terms of train control functions, ride quality is governed by those elements of the system that regulate speed and execute programmed station stops. Three aspects of motion must be controlled: speed, acceleration, and the rate of change of acceleration.

Acceleration and deceleration (the rate at which speed changes) is related to, but not actually a part of, the speed regulation function of the train control system.⁵² For passenger comfort, as well as safety, the changes in velocity must be kept within certain limits when running the train up to speed and when coming to a stop at stations. Different rates may be employed—a nominal rate for service braking and a somewhat higher rate for emergency stops.

It is important to control not only acceleration but also jerk—the rate of change of acceleration, so named because of the uncomfortable (and potentially hazardous) effect produced by abrupt changes in acceleration or speed.⁵³ Control of jerk, more than control of acceleration itself, contributes to a smooth ride and, for the standing passenger, a somewhat safer one. Jerk limiting applied during stopping is sometimes called flare-out control. It is identical to the technique employed by a skilled automobile driver when coming to a stop. By easing off on the brake, the transition from deceleration to full stop is smoothed or feathered out. Because there are safety implications to relaxing braking effort while stopping, flare-out control (a train operation function) is overridden by the train protection (ATP) system such that flare-out is prevented during emergency braking.

Maintaining optimum wheel-rail adhesion is called slip-slide control. Slip denotes the slipping or spinning of wheels during the application of power. Slide denotes the sliding or skidding of wheels when brakes are applied. Both are operationally un-

⁵²Acceleration and deceleration control is considered by transit engineers to be a part of the traction system. While it is true that the equipment controlling acceleration and deceleration is physically a part of the traction system, the functional boundary between this system and the train control system is somewhat fuzzy, and a case can be made for treating acceleration and deceleration control as part of either one. In practical terms, the distinction is unimportant since speed regulation, acceleration and deceleration control, and jerk limiting all interact to produce a smooth ride.

⁵³Jerk limiting is also considered technically a function of the traction system. The train control system commands a specific level of acceleration, and the propulsion system responds by application of power or braking to produce acceleration/deceleration at a rate within allowable equipment or human tolerances.

desirable because they represent inefficiency in running the train and may cause damage to tracks, wheels, or the propulsion and braking system of the train. For the passenger's perception of ride quality, slip-slide control is only marginally important, but it does affect jerk characteristics. There are also safety implications; the system is usually designed so that failure of slip-slide control does not allow release of brakes when safety requires that they be applied.

In transit systems where trains are operated manually, speed regulation, slip-slide control, and flare-out are usually performed by the motorman.⁵⁴ The ride quality resulting for the passenger is thus determined by the skill or artistry of the individual motorman and the consistency with which he applies proper technique. In transit systems with ATO, these three functions are usually automatic. The use of automatic mechanisms is generally considered to offer two advantages. First, the train is more likely to be operated within the limits acceptable for passengers and equipment because the control system is designed to preclude human error and improper technique. Second, automatic operation leads to less variation; human control varies considerably with individuals and time.

Table 14 is a summary of the speed regulation, jerk limiting, and slip-slide control methods employed in five operating transit systems. The new transit systems planned for Washington, Atlanta, and Baltimore will all employ automatic techniques similar to those of PATCO or BART.

There is almost no empirical evidence to support or refute the advantages claimed for ATO on theoretical grounds. Systematic studies in experimental settings or under actual operating conditions have not been conducted, and there is no effort now under way to do so. The opinion of some transit system engineers is that ATO leads to a ride quality and type of train operation that is at least as good as manual control, and perhaps even superior because of the ability of automatic devices to operate within prescribed tolerances more consistently. Transit system managers also seem inclined to this view. There is, however, some dissenting opinion from both engineers and managers. Perhaps the most conclusive indication that ATO is preferable to manual control is that all the transit systems now under development and most of the proposed extensions or improvements to existing systems will

⁵⁴Jerk limiting is automatic on all operating transit systems and is built into the propulsion system.



FIGURE 54.—Comfort Features of Modern Transit Cars

TABLE 14.—Train Operation Methods Related to Ride Quality

TRANSIT SYSTEM	ACCELERATION RATE			
	ACCELERATION	JERK LIMITING	FLARE-OUT	SLIP-SLIDE
NYCTA	Automatic]	Automatic	Manual, except on new R-44 and R-46 cars when operating with ATO	Manual, except on new R-44 and R-46 cars
CTA	Automatic]	Automatic	Manual	Manual
MBTA	Automatic	Automatic	Manual	Manual, except on new Red Line cars
PATCO	Automatic	Automatic	Automatic on service brakes, except in manual backup mode: none on emergency brakes	Automatic in all propulsion and braking modes, including emergency braking
BART	Automatic	Automatic	Automatic on service brakes, except in manuall back-up mode: none on emergency brakes	Automatic in all propulsion and braking modes, including emergency braking

¹Inherent in propulsion system design.

incorporate automatic control of acceleration, jerk, flare-out, and slip-slide.

ISSUE O-6: LEVEL OF SERVICE

Do transit systems with ATC provide a level of service that is comparable to manually controlled systems?

Generally yes, although some systems with ATC have encountered difficulty in maintaining schedules, especially during the initial months of service.

Level of service is a general term that includes both the characteristics of the service offered (speed, trip time, frequency of trains) and the dependability of that service. Designers of transit systems consider these aspects of service, along with comfort and convenience, to be determining factors in gaining and holding public patronage. The assumption is that if travel time can be saved by using rail rapid transit, if service is available when wanted, and if there is assurance that the trip will be completed according to schedule, a large share of the public will choose rail rapid transit over other modes of transportation. Advocates of automation contend that ATC offers the means to upgrade service by making it possible to operate trains at greater speeds, on shorter headways, in closer conformance to schedule, and with greater regularity,

Maintaining a high level of service depends on how well both the train operation and train supervision functions are carried out. The elements of the system responsible for operating trains, whether the motorman or an automatic device, must assure that trains are run at the prescribed speeds, making the scheduled stops and departing from stations after the specified dwell times. The train supervision function, either by humans or computers, entails monitoring the performance of individual trains in relation to overall passenger demand and making compensating adjustments of schedule, running time, station stops, and dwell time as necessary to overcome irregularities of train operation, variations in demand, or adversities of weather. The success of this combined train operation and supervision activity is measured by schedule adherence, i.e., the percentage of time that trains are actually

run according to schedule, making the prescribed stops, and with the requisite number of cars.⁵⁵

Table 15 is a summary of the service-related performance characteristics of five transit systems with various degrees of automation of train operation and supervision functions. Also shown are the service characteristics of the AIRTRANS system at Dallas-Fort Worth Airport. Although AIRTRANS is an airport people-mover system in the AGT class and not a true rail rapid transit system, it has been included as example of a wholly automated system operating without on-board personnel. No existing rail rapid transit system operates in this manner. The data for AIRTRANS, BART, PATCO, and NYCTA apply to the entire system. The CTA and MBTA data are for only the most automated lines.

The speeds and headways for the two rail rapid transit systems with ATO (BART and PATCO) are generally equivalent or superior to those of the systems with manual train operation.⁵⁶ It must be noted, however, that maximum speed is little influenced by ATO. Speed is mainly a function of track condition, vehicle characteristics, age of equipment, and station spacing, to name a few. Thus, the higher speeds attained in BART and PATCO do not necessarily reflect an superiority of ATO over manual operation. These systems are newer, in better condition, and built for different purposes.⁵⁷ The track and rolling stock have been designed for high-speed operation. Station spacing permits longer runs at maximum speed, thereby raising the average line speed. Still, the data do suggest that systems with ATO are capable of providing a level of service at least equivalent to that of manual systems,

With regard to headways, ATO does seem to offer advantages over a manual system. Headway is basically determined by the level and quality of signal protection (ATP) and the regularity with which

⁵⁵Ultimately, level of service depends more on management policy than technological features, since it is management that sets the desired level of service and determines the degree of commitment to maintaining service in the face of adverse circumstances.

⁵⁶Speed in the AIRTRANS system is substantially lower, but this is a result of very close station spacing (typically 1,000–2,000 feet) which does not permit vehicles to operate at maximum speed for more than a few seconds.

⁵⁷BART and PATCO are basically interurban systems more comparable to the Long Island Rail Road or Penn Central's commuter services than to the NYCTA or CTA urban transit systems.

TABLE 15.-Service Characteristics in Typical Transit Systems

TRANSIT SYSTEM	AUTOMATION			SPEED (mph)		HEADWAY (min.)		Maximum Trips/Day Train (each way) Length (cars)	One-Way Trip Time in Peak Period (min.)	
	ATP	ATO	ATS ²	Max,	Av.	Peak	Base			
NYCTA	J			50	20	2	10-12	11	8,000	359
CTA (Dan Ryan) ~				55	30	3	5	8	225	42 1/2
MBTA (Red Line)	4		J ⁴	50	30	2 1/2	4 1/2	4	255	25
PATCO	1	1	J	75	40	2	10	6	182	22 1/2
BART	J	J	J	80	40	56	6	10	5280	54-57
AIRTRANS	J	d	d	17	9	6 ¹	-	2	-6	-6

¹A check (✓) indicates the function is automated. All but AIRTRANS have an on-board operator to run the train or monitor automatic system performance.

²Automation here specifically means computer-aided central control.

³System-wide average; trip time on individual lines varies considerably as a function of line length and whether service is local or express.

⁴A portion of the route is equipped for ATO but currently operates under manual control. Cars are capable of 70 mph top speed but are governed to 50 mph for manual operation.

⁵The figures are for interim level of service; when fully operational, approximately 600 trips per day will be run at headways of 2 minutes during peak periods and 4 minutes during the base period.

⁶AIRTRANS operates 17 overlapping loop routes of varying length. Trains circulate continually throughout the day on a schedule determined by aircraft arrivals and departures.

trains are operated, i.e., the invariance of running time. There is a large, but not unanimous, body of opinion among transit engineers and managers that ATO is necessary in order to operate trains at high speeds on short headways. Given a signal and train protection system of good quality, trains can be run manually on short headways, viz., NYCTA or CTA, where scheduled headways on individual lines are on the order of 1-2 minutes and composite headways on merged lines sharing a single track may be 40-50 seconds. Given the proper equipment and track conditions, trains can also be run at high speed under manual control. Metroliners have operated manually in regular service at speeds of up to 130 mph. But some transit engineers and planners believe that the combination of high speed and short headway cannot be attained without the help of ATO to eliminate the variability of manual operation.

Data to support this contention are scarce because there is only one transit system (PATCO) where manual and automatic modes of operation can be directly compared. The PATCO trains are normally run under ATO, but full-speed manual operation is possible as an alternate mode and is, in fact, required of each train operator once a day as a

means of maintaining proficiency. The PATCO experience has been that the trips run under manual control average about 20 seconds longer and are of much greater variability than ATO runs. Since these manual proficiency trips are not run during peak periods, the impact of longer and more variable running time on headway is hard to assess, but the effect might be to increase headway and so lessen the overall throughput of the system. On the other hand, the PATCO results may be misleading because they were obtained while running with a clear track ahead. Some transit engineers contend that, when trains must follow closely or when track and weather conditions are adverse, the manual operator is superior to the automatic device; and trains can be run more uniformly, at closer headways, and with shorter running times,

For the transit patron, the schedule of train service is only part of the equation. The patron also requires assurance that the schedule will be maintained with a high degree of consistency. That is, the performance history of the system must lead the patron to the conclusion that he can rely on the trip being completed, on time, without skipping scheduled stops, and with the customary amount of car space available.



FIGURE 55.—The Wait

. and the Rush to Leave



Schedule adherence of transit systems is not strictly comparable because of differing definitions of on-time performance and dissimilar methods of keeping operational logs. For example, some systems consider a train on time if it arrives at a terminal within the turnaround time, i.e., in time to depart on schedule for the next run. Others use an arbitrary definition, such as a delay not exceeding 5 minutes, either at a terminal or at checkpoints along the route. Still others, such as BART, use a more dynamic and detailed measure of schedule adherence that takes into account the impact of individual delays on total system performance.

Schedule adherence is also influenced by the strategy employed in setting a schedule. One ap-

proach is to base the schedule on maximum train performance (maximum attainable speed, acceleration, and deceleration and minimum coasting time) with the expectation that maximum throughput will be achieved except for a small fraction of the time when complications arise. An alternative approach is to schedule trains at something less than their maximum performance, thereby creating a built-in reserve of performance that can be used to make up delays en route. This approach sacrifices some throughput but offers greater assurance that the schedule can be met.

Because of these dissimilarities in setting schedules and defining on-time performance, direct comparisons across transit systems cannot be made,

The following data, therefore, should be regarded only as individual examples of schedule adherence for representative transit systems.

PATCO

A train is considered late in PATCO if it arrives at a terminal more than 5 minutes behind schedule. PATCO keeps a daily log of lateness and other schedule anomalies such as trips annulled, station stops missed, and trips made with less than the scheduled number of cars (short consist). Table 16 shows the performance figures for 1974 and for an average year in the period 1970–74.

PATCO also computes an overall index of schedule adherence:

$$\text{Schedule Adherence} = 100 \frac{T_s - T_a - T_l - 0.1 (Sb)}{T_s}$$

where:

T_s = trips scheduled

T_a = trips annulled

T_l = trips late

Sb = stations bypassed

Applying this formula gives a figure of 98.71 percent schedule adherence in the 5-year period 1970–74 and a figure of 98.34 percent in 1974. It is worth noting that in 1974, despite a derailment due to traction motor failure and a subsequent schedule disruption caused by replacement of motor bearings for all cars in the fleet, PATCO was able to sustain a level of performance nearly equal to that of the preceding 4 years—98.34 percent in 1974 versus 98.80 percent in 1970–73.

TABLE 16.—Schedule Adherence in PATCO, 1970–74

PERFORMANCE	1974	FIVE-YEAR AVERAGE (1970-74)
SCHEDULED TRIPS		
Percent on time	98.36	98.75
Percent late	1.16	1.03
Percent annulled	0.48	0.23
SCHEDULED STOPS BYPASSED (%)		
	0.18	0.40
TRIPS MADE WITH SCHEDULED NUMBER OF CARS (%)		
	99.66	99.75

CTA

CTA has a very stringent definition of lateness and employs a complex strategy to compensate for delays. A train is considered late if it is more than 30 seconds behind schedule at a terminal or intermediate checkpoint. When this occurs, preceding and following trains are deliberately delayed also so as to minimize irregularity in headways and balance the service.

For the purpose of this report, a special study was made of schedule adherence on one CTA line, the West-South (Lake-Dan Ryan), which is one of the newest lines and operates with cab signals. On-time was defined to be arrival at a terminal with a delay not exceeding the scheduled turnaround time, i.e., the actual time of arrival was not later than the next scheduled departure of the train. Depending on the time of day, turnaround time on this line is between 5 and 7 minutes—a standard roughly comparable to that of PATCO. In addition to delay, the analysis also considered the number of trips annulled, scheduled station stops bypassed, and consist shortages. Table 17 is a summary of findings for the year 1974 and for the 5-year period 1970–74.

TABLE 17.—Schedule Adherence on CTA Dan Ryan Line, 1970–74

PERFORMANCE	1974	Five-Year Average (1970-74)
SCHEDULED TRIPS		
Percent on time	96.26	97.37
Percent late	3.65	2.50
Percent annulled	0.09	0.13
SCHEDULED STOPS BYPASSED (%)		
	0.34	0.26
TRIPS MADE WITH SCHEDULED NUMBER OF CARS (%)		
	99.93	99.89

Despite certain basic differences between PATCO and the CTA Dan Ryan line in route complexity, track geometry, and station spacing, the performance histories of the two systems are roughly comparable when logged on essentially the same basis. The on-time records of both are on the order of 97-78 percent, and the percentage of stops made and the percentage of trips run with a full consist are nearly 100 percent. Thus, it would appear that a manual system with ATP (CTA) and an

automated system with ATP and ATO (PATCO) can achieve equal levels of schedule adherence.

NYCTA

The rapid transit system operated by NYCTA is the largest and most complex in the United States. Automation is minimal, consisting of automatic train protection by wayside signals with trip stops and some automated dispatching. Train operation is wholly manual.

In 1974, the on-time performance record of NYCTA was 97.03 percent, where a train is considered on time if it arrives at a terminal within 10 minutes of the schedule. During 1974, there were 32,515 delays of unspecified length, or about 90 per day or three per line,

AIRTRANS

AIRTRANS at the Dallas/Fort Worth Airport has a fully automatic train control system. Automated trains operate on 17 intermeshed routes over about 13 miles of one-way track. The system is still in the

process of shakedown and debugging, having opened for operation in January 1974.⁵⁸

Figure 56 is a plot of the availability of the system on a weekly basis from May to October 1974, where availability is expressed as the ratio of actual hours of operation to scheduled hours of operation. The figure also shows the number of service interruptions experienced each week.

It can be seen that, during the month of May, a relatively few service interruptions caused long delays. In June, the schedule of operation was increased from 105 to 168 hours per week, and the number of service interruptions increased sharply to over 160 per week, or about one per hour. As experience was gained and debugging of the system continued, the length of delay per interruption decreased. By October, system availability averaged over 99 percent, while the number of service interruptions declined to about 40 per week. While serv-

⁵⁸In November 1975 the system was shut down as a result of a contract dispute between the airport management and the manufacturer.

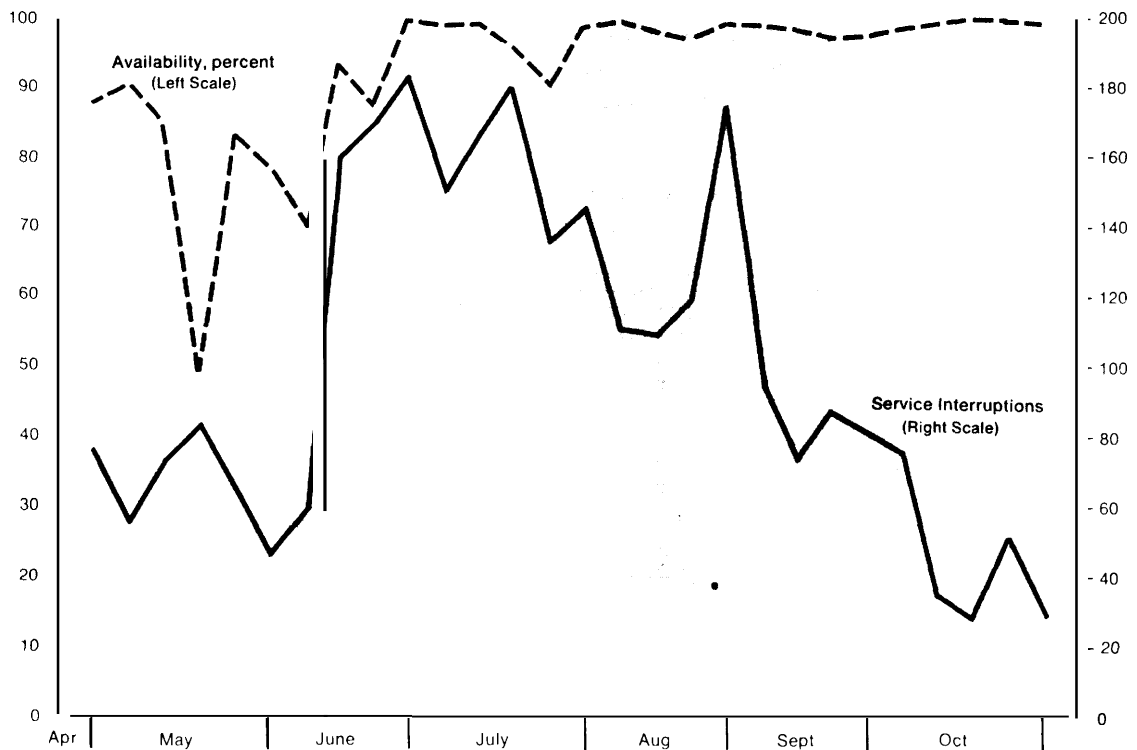

FIGURE 56.—AIRTRANS Availability and Service Interruptions

ice interruptions are not truly equivalent to late trips, it may provide perspective to consider that PATCO experienced about 20 late trips per week and the CTA Dan Ryan line about 54 per week during the first year of operation.

BART

BART has ATO and employs a computer-based ATS system for maintaining trains on schedule. The basic performance index is "total system offset," an expression of the aggregate delay for all trains operating in the system after application of corrective scheduling algorithms. This measure is more complex than that used by other transit systems, not only because it incorporates more factors, but also because it considers the compensating adjustments which have been applied to following and leading trains, in addition to the late train itself. Thus, a train that is 30 seconds late will result in delays of 5 to 15 seconds for as many as three following and two leading trains, producing a total system offset of as much as 65 seconds while the central control computer respaces the trains and smooths out the traffic flow.

During the first 9 months of operation, under a partial schedule with 10-minute headways, BART experienced severe service disruptions. In the week of 25–29 June, 1973, for example, total system offset averaged about 12 minutes in the morning and increased to over 45 minutes by the evening rush hour. Delays of over 10 minutes were experienced

five times during the week, and short consists were run 16 times for periods ranging from 16 minutes to 3 hours.

Table 18 shows a larger sample of data, consisting of weekly performance summaries selected at approximately 4-week intervals from August 1973 to August 1974. During this period, which covers roughly the second year of operation, transbay service had not yet been inaugurated, and BART was running what amounted to two separate systems: Fremont/Richmond/Concord service in the East Bay and San Francisco/Daly City service in the West Bay. Service was limited to the hours of 6 a.m. to 8 p.m., weekdays only.

Examination of the data for the period indicates a slight improving trend with respect to delays, car shortages, and total system offset. The opening of the Transbay Tube in September 1974 caused a sharp decline in the regularity of service for a few weeks; but by the last week of 1974, total system offset was running at an average of 3.6 minutes in the morning and 20.4 minutes in the evening. These figures are roughly comparable to those of August 1974, the month preceding inauguration of transbay service. Still, it appears that the BART system has not yet attained a level of service dependability comparable to other rail rapid transit systems.

Other Transportation Modes

To assess the general quality of service provided by rail rapid transit, it is useful to make some rough

TABLE 18.—Schedule Adherence in BART, August 1973–August 1974

WEEK	WEEKLY TOTAL			TOTAL SYSTEM OFFSET (minutes)	
	Trains Dispatched	Delays Over 10 min.	Short Consist	Daily Average 7:00 a.m.	Daily Average 4:30 p.m.
20–24 Aug. 73	116	8	11	8.2	36.0
17–21 Sep. 73	124	10	12	4.8	23.0
15–19 Oct. 73	135	18	21	9.2	45.4
12–16 Nov. 73 ¹	149	10	17	9.0	39.8
10–14 Dec. 73	166	9	26	9.6	19.0
7–11 Jan. 74	166	9	38	11.8	28.6
18–22 Feb. 74	170	5	17	10.8	22.6
18–22 Mar. 74	172	5	19	3.4	36.6
8–12 Apr. 74	170	8	23	7.8	24.6
13–17 May 74	145	6	25	2.8	16.8
10–14 Jun. 74	162	5	28	2.2	23.6
8–12 Jul. 74	164	2	18	6.6	21.6
5–9 Aug. 74	185	8	26	0.8	15.6
AVERAGE	156	8	22	6.7	27.2

¹West Bay service began on November 5 1973

comparisons with other modes of public transportation. The on-time performance records of the rail rapid transit systems examined here range from 97 percent for an essentially manual system (NYCTA) to almost 99 percent for a system with ATP and ATO (PATCO). The on-time performance of more highly automated systems such as BART and AIRTRANS cannot be determined from the data available, but it appears to be not lower than 90 percent.

The Metroliner operating between New York and Washington is comparable to rail rapid transit since it operates on a fixed guideway in an exclusive right-of-way and employs similar train control technology. The on-time record of the Metroliner is currently running at about 53 percent, where a train is counted late if it arrives more than 15 minutes behind schedule on a trip of 3 hours. On-time performance for railroads in general exceeds 90 percent for many lines and in some cases reaches 95 percent (Reistrup, 1975).

Air carrier service is a more remote comparison, but still generally valid if limited to flights of about the same duration as a typical rail rapid transit run. The on-time performance record in September 1974 is given below for air carrier service between three pairs of cities about one flight-hour apart:

New York–Washington	79 percent
Los Angeles–San Francisco	84 percent
Los Angeles–Las Vegas	84 percent

(Air Transport World, 1975)

A flight is considered on time if it arrives within 15 minutes of schedule, a less stringent standard than the 5–10 minutes used in the rail rapid transit systems cited above,

ISSUE O-7: RELIABILITY

What effect has ATC equipment reliability had on the performance of transit systems?

ATC equipment poses reliability problems, especially during the initial period of system operation. However, in comparison with other components of the transit system, ATC equipment does not cause a disproportionate share of service disruptions. The problems do not seem to stem from automation per se but from the increased complexity of all new transit system equipment,

The general trip dependability, or schedule adherence, of rail rapid transit systems employing manual or automatic train control was examined in the previous issue. It was found that the method of train operation, either manual or automatic, did not have a major influence. The principal cause of schedule irregularity and service disruptions is not how dependably the train is operated, but how serviceable is the transit equipment itself. Thus, schedule adherence ultimately reduces to a question of whether the equipment can render service when needed.

Technically, the ability of equipment to render service when needed is known as availability and embraces two separate concerns:

- (1) Reliability—the ability of the equipment to operate as required at any given time,
- (2) Maintainability—the ability of the equipment to be restored to operating condition after failure.

The two are closely related, but only the matter of reliability will be examined here. Maintainability is taken up as the next issue. To provide some perspective for these issues, however, a brief description of the general nature of reliability, maintainability, and availability (RMA) is in order,

Reliability, maintainability, and availability are linked in a relationship that can be expressed mathematically as:

$$A = \frac{R}{R + M}$$

where A = the proportion of time the equipment is available for service

R = reliability, expressed as the time that the equipment will operate as required or as the mean time between successive failures (MTBF)

M = maintainability, expressed as the mean time to repair (or restore) to serviceable condition (MTTR)

In effect, the entire expression reduces to a statement of the probability that the equipment will be available in working condition, or that the passenger will find the transit system fully operational at any given time,

The general standard in transit systems is for the reliability (MTBF) of major assemblies or sub-systems to be on the order of 1,000 hours or more. Repair time (MTTR) is typically 1 or 2 hours. Combining the separate MTBF and MTTR for all sub-systems yields an expected availability of roughly 98 to 99 percent for the entire system. The issues to be examined here are whether this expectation is, in fact, realized and what part is played by ATC equipment in the overall RMA picture.

Despite the recognition in the transit industry that reliability is perhaps the single most pressing technical problem, this study did not uncover a significant body of operational data on the performance of vehicle and wayside equipment components. Some transit agencies attempt to maintain a systematic data bank of reliability information, with computer analysis and calculation of component reliability rates (MTBF). Others have a less formal system consisting of shop logs, summaries of individual failure reports ("bad orders"), and other such working records. The methods of recording failures differ among transit systems. Some record failures at the component level, others group these failures in higher order assemblies, such as sub-systems or replaceable modules. The definition of what constitutes a failure also varies. Some count reports of failure by train operators; others count only failures confirmed by shop personnel and exclude the so-called "false bad order" or intermittent failure. Still others count only those failures that disable a train or cause it to be removed or withheld from operation.

For those that calculate MTBF, some use a time base that includes all the hours the equipment is actually in operation, counting the time in revenue service as well as the time in yards or on storage tracks when the equipment may be energized but the train not running. Others count only revenue service hours. This difference alone can have significant impact on the calculated failure rate. At BART, for example, it is estimated that yard time is about twice the revenue hours.

As a result, a quantitative analysis of reliability could not be performed in such a way to permit detailed comparison of experience with ATC equipment among transit systems. The following summaries of equipment failure and reliability information for individual systems are therefore not to be compared, except at the most general level and only within the limits noted in the discussion.

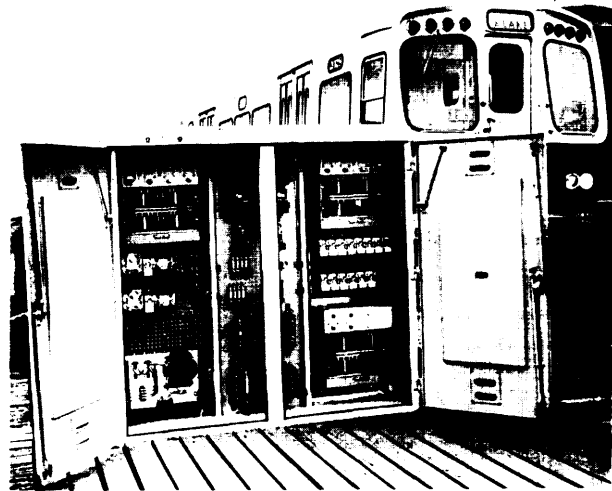
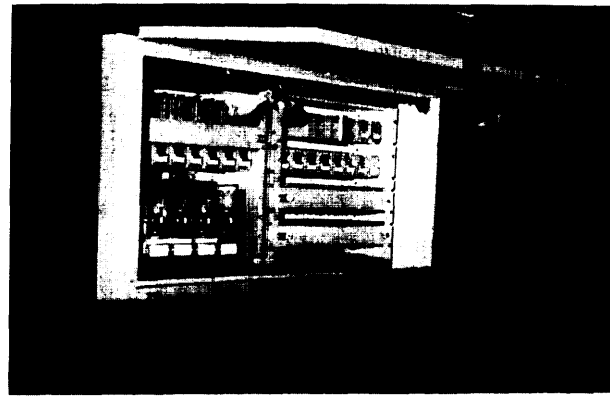

FIGURE 57.--Carborne and Wayside ATC Equipment

PATCO

PATCO has a computer-based reliability and maintenance record system that produces summaries of failure data at 4-week intervals. Table 19 is a sample of car component performance data for a representative 16-week period from mid-July to the end of November 1974. Only certain categories of equipment failure have been selected—ATC equipment and a sample of other major components generally considered reliable. Data on periodic inspection and preventive maintenance have also been included to indicate the proportion of scheduled to unscheduled maintenance events.

It can be seen that ATC equipment failure accounts for about 6 percent of all maintenance events—roughly the same as the propulsion control equipment (cam controller) and air brakes, two conventional items of car equipment that are generally

TABLE 19.—PATCO Car Component Performance, July-October 1974

COMPONENT	NUMBER OF FAILURES					TOTAL	4-WEEK AVERAGE	PER- CENTAGE OF ALL FAILURES
	13 Jul- 9 Aug.	10 Aug.- 6 Sep.	7 Sep.- 4 Oct.	5 Oct. - 1 Nov.				
ATC	66	73	100	45	284	71	5.7	
Air Brake	74	52	101	48	275	69	5.5	
Cam Controller	47	89	84	68	268	72	5.8	
Communication Controller	26	31	30	31	118	30	2.4	
Controller	20	17	42	31	110	28	2.2	
Coupler	60	72	197	95	424	106	8.5	
Master Controller	5	1	7	4	17	4	0.3	
Motor-Generator	34	36	56	42	168	42	3.4	
All Other	1201	698	788	634	3321	830	66.3	
Periodic Maintenance	219	270	449	275	1213	303		

¹High voltage switches.

²Operator's control unit in cab.

regarded as reliable elements. The incidence of coupler failure is about one and one-half times as high as that of ATC equipment. PATCO was experiencing a problem with couplers at that time, necessitating a redesign and replacement of the original equipment. The failure rate for couplers was therefore unrepresentatively high during the sample period. From these data, it can be concluded that ATC equipment at PATCO, accounting for about one failure in eighteen for the all carborne components, is not a reliability problem of disproportionate magnitude.

A separate analysis, performed by Battelle Columbus Laboratory in support of this study, considered only disabling failures⁵⁹ and covered a 1-year period from August 1973 to July 1974. These data, presented in table 20, indicate that ATC failures accounted for about 10 percent of all train removals during the year, but with considerable variance. ATC failures, expressed as a percentage of all disabling failures, ranged from as low as 7 percent to as high as 22 percent. Using these data, Battelle also calculated MTBF for vehicles as a whole and for carborne ATC equipment. Vehicle MTBF was found to be 23.9 hours, and the ATC MTBF was about 227 hours. Since cars were operated an average of 30 hours per week, each car had about 1.2 disabling failures per week.

⁵⁹A disabling failure, as defined by PATCO, is one that would require removal of a train or car from service or prevent its return to service after leaving the line at the end of a scheduled run.

ATC accounted for about one-tenth of the removals, or roughly one removal per car every 8 weeks. Thus, ATC reliability accounted for 6 percent of all failures but about 10 percent of removals from service, a reflection of the criticality of ATC to train system performance. Still, the magnitude of disabling failures due to ATC was not large—representing about one incident per car every 8 weeks or, for the whole fleet of 75 cars, 488 removals due to ATC out of the 4,797 experienced in a year.

BART

Like PATCO, BART has a computer-based recordkeeping system for reliability and maintainability information. However, because of differences in the definition of failure and the equipment categories in which data are tabulated, reliability data for the two systems cannot be directly compared. Table 21 is a summary of reported failures by major equipment categories for the period January 1, 1974, to January 21, 1975. Two major classes of equipment are included, carborne equipment and wayside equipment. The latter class includes a substantial amount of train control equipment required for ATP (interlocking control), ATO, and ATS.

The failure of BART carborne ATC equipment accounts for about 11 percent of all carborne equipment failures, a proportion almost identical to that of PATCO, if it is assumed that all the BART

TABLE 20.—Summary of Disabling Equipment Failures in PATCO, August 1973–July 1974

Four-Week Interval Ending	Total Failures ¹	Disabling Failures ²		ATC Failures ³	
		Number	Percentage of total	Number	Percent of Disabling
8/10/73	755	425	56.3	73	17.2
9/7/73	1161	777	66.9	47	6.1
10/5/73	1339	913	68.2	95	10.4
11/2 /73	1234	835	76.7	84	10.1
11130/73	1197	769	64.2	78	10.1
12/28/73	1180	788	66.8	56	7.1
1/25/74	1193	716	60.0	57	8.0
2/22/74	1399	839	60.0	69	8.2
3/22/74	1298	807	62.2	53	6.6
4/19/74	962	541	56.2	120	22.2
5/17/74	1105	690	62.4	91	13.2
6/14/74	1197	682	57.0	108	15.8
7/12/74	1206	682	56.6	66	9.7
Total	15,226	9,464	62.2	997	10.5
Average	1,171	728	62.2	76.7	10.5

Battelle calculations, based on PATCO data)

¹Does not include preventive maintenance or cleaning.

²Defined by PATCO to be critical failures that would require removal of a train or would prevent its return to service after leaving the line at the end of its scheduled run.

³Does not include communications since PATCO does not consider this disabling.

TABLE 21.—Summary of Equipment Failure in BART, 1974–751

COMPONENT	Number of failures	Average per month	Percent of total failures	Failures per car per month ²
Carborne Equipment:				
ATC	1,295	102	10.9	0.35
Air Conditioning	504	40	4.3	0.14
Auxiliary Electrical	834	66	7.1	0.22
Car Body	1,676	132	14.2	0.45
Communication	500	40	4.3	0.14
Doors	598	47	5.0	0.16
Friction Brake	1,375	109	11.7	0.37
Propulsion	4,158	329	35.3	1.15
Suspension	222	18	1.9	0.06
Truck	614	49	5.3	0.17
TOTAL CARBORNE	11,774	932	—	³ 3.16
Wayside ATC Equipment:				
ATO	339	27	21.3	NA ⁴
ATP ⁵	696	55	43.3	NA
ATS (Central)	41	3	2.4	NA
Power	31	2	1.6	NA
Switch & Lock	198	16	12.6	NA
Yard Control	299	24	18.9	NA
TOTAL WAYSIDE ATC EQUIPMENT	1,604	127	—	—

¹The period covered is from January 1, 1974 to January 21, 1975, 12.65 months.

²Based on an average fleet size of 295 (145 A-cars, 150 B-cars) during the period.

³Does not sum because of rounding in individual calculations.

⁴Not applicable.

⁵Includes multiplex and interlocking control equipment.

failures should be counted as disabling. To this, however, must be added the failures of wayside equipment, which in BART accounts for a sizable share of the train control system. BART wayside ATC equipment, including central supervisory (ATS) equipment, experiences about 127 failures per month, the equivalent of 6 per day.⁶⁰ In comparison with carborne equipment failures, wayside failures tend to have more widespread consequences because all trains operating in the vicinity (or, if a central control failure, all trains in the system) are affected.

Reliability of equipment has been a major problem in the BART system. For example, an analysis of the operating logs for the period May 1974 to January 1975 shows that only slightly over half of the car fleet was available for service at any given time and that availability declined regularly throughout the day and week. The problem was particularly severe with the A-cars, which contain the train control electronics. In an average week during this period, only 71 of the 148 A-cars (48 percent) were in running condition. From Monday to Friday, availability declined by an average of 8 cars, often leaving fewer than 65 A-cars in service by Friday.

The extent to which ATC equipment reliability contributes to the overall pattern of car problems and service disruptions could not be determined conclusively. The BART staff estimated that ATC was initially cited as the reason for about 20 percent of all train removals, but the actual figure may be somewhat lower if "false bad orders" are discounted and only confirmed ATC failures are considered. Even so, ATC is not the single largest cause of train removal. Propulsion motors, car body defects, and brakes each account for a larger share of car system failures than ATC.

CTA

Automatic train control equipment in CTA consists of wayside signals with trip stops on some parts of the system and cab-signal ATP on others. Since the extent of train control automation is lower than in PATCO or BART, it would be expected that the proportion of train removals due to ATC failure would also be lower. This hypothesis

cannot be conclusively affirmed because CTA does not maintain a formal equipment reliability record that would allow MTBF to be calculated directly. However, a partial analysis, performed as part of this study, sheds some light on the situation.

An analysis of carborne equipment reliability on the West-South route for a representative 16-week period in 1974 was performed by CTA personnel at the request of the OTA staff. The results are shown in table 22. Because two different types of cars are operated on this line (180 2000-series cars and 78 2200-series cars) failures for each are tabulated separately. Cab signal equipment, although listed as a single entry, is of two types—one a rather simple and conventional design and the other more complex and technologically advanced.

Cab signals are the largest failure category for equipment on the West-South route, accounting for 44 percent of the sample of cases reported; but there are several factors operating here that may have distorted the results. First, this is only a partial listing of failures. When considered in the context of all equipment failures, cab signal failures would represent a lower proportion. CTA maintenance personnel estimate that cab signal failures account for no more than 20 percent of all "bad orders." Second, it should be noted that the total of 307 cab signal failures listed in table 22 are reported failures. Shop personnel confirmed only about 60 percent of this number—the remainder being either erroneous reports by motormen or intermittent failures that could not be duplicated in shop tests. This illustrates the general problem of confidence in reliability statistics, where the basic data may be questionable because of incorrect initial diagnosis or the inherent difficulty in troubleshooting electronic equipment. Third, the cab signal failures reported here are not all disabling failures. Some are malfunctions of nonessential features, such as burned-out indicator bulbs, that do not affect the performance of the equipment for basic train protection functions. Fourth, the West-South route was in the process of converting to cab signal operation during the time period considered in this sample. The general experience of CTA has been that equipment reliability is particularly troublesome during the initial installation and check-out period. This is true not only of cab signals but any other new and complex type of transit equipment introduced in an established system.

⁶⁰BART operates only on weekdays, or about 20–21 days per month.

TABLE 22.—Car Component Performance on CTA West-South Route, July–October 1974

COMPONENT	Number of Failures					TOTAL	4-WEEK AVERAGE	Failures per car per week
	13 Jul. – 9 Aug.	10 Aug. – 6 Sept.	7 Sept. – 4 Oct.	5 Oct. – 1 Nov.				
Cab Signals								
Reported Defective (Confirmed)	(.)	69 (47)	73 (48)	92 (51)	307 (185)	77 (46)	0.08 (0.04)	
(Unconfirmed)	(34)	(22)	(25)	(41)	(122)	(31)	(0.03)	
Doors								
2000-Series ¹	(13)	(21)	(29)	(29)	(92)	(23)	(0.03)	
2200-Series ¹	(26)	(14)	(15)	(16)	(71)	(18)	(0.06)	
All cars	39	35	44	45	163	41	0.04	
Dynamic Brakes								
2000-Series	(19)	(12)	(19)	(19)	(71)	(18)	(0.03)	
2200-Series	(4)	(5)	(5)	(2)	(16)	(4)	(0.01)	
All cars	23	17	24	21	87	22	0.02	
Friction Brakes								
2000-Series	(7)	(7)	(10)	(19)	(43)	(11)	(0.02)	
2200-Series	(10)	(14)	(25)	(22)	(71)	(18)	(0.06)	
All cars	17	21	35	41	114	29	0.03	
Traction Motors								
2000-Series	(3)	(5)	(8)	(4)	(20)	(5)	(0.01)	
2200-Series	(3)	(2)	(0)	(0)	(5)	(1)	—	
All cars	6	7	8	4	25	6	0.01	

¹Two types of cars are operated: 180 200(-) series cars (purchased 1964) and 78 2200-series cars (purchased 1969–70).

NYCTA

NYCTA has wayside signals and trip stops for ATP and virtually no carborne ATC equipment except on the R-44 and R-46 cars.⁶¹ The experience of NYCTA with equipment reliability is, therefore, a useful baseline from which to estimate the general performance of car components other than ATC.

During 1974, there were 32,515 delays in service in NYCTA, about 90 per day. Of these 16,872 (52 percent) were chargeable to car equipment failure. During the same period, wayside signal failures accounted for only 1,435 delays, or 4.4 percent.

Using NYCTA data, Battelle Columbus Laboratory estimated that the reliability of NYCTA cars was about 842 hours MTBF. However, there was great variability among the different models of

cars. The older equipment, despite having been in service much longer, was five to ten times more reliable than the newest equipment—the R-44 series cars. For example, the R-36 cars (purchased in 1962) had 4,048 hours MTBF; and the R-38 cars (dating from 1965), had 2,126 hours MTBF.⁶² In contrast, MTBF for the new R-44 cars was only 421 hours—or about half that of the fleet as a whole.⁶³ Preliminary indications are that the newest equipment, the R-46 series now being delivered, have even less low reliability.

This experience suggests that some of the reliability problems experienced by new systems such as PATCO and BART result not so much from train control automation as from the general complexity of the newer transit vehicles. All types of

⁶²The R-36, R-38, and R-44 cars were all purchased from the same manufacturer.

⁶³The average age of the NYCTA fleet is 17 years, with almost one-sixth having been in service over 28 years. All of these oldest models had an MTBF greater than that of the R-44 cars.

⁶¹The R-44 and R-46 cars are equipped with cab signals; but since the wayside equipment associated with cab signaling has not yet been installed, the cars are run with the cab signal units cut out.

car equipment have grown more complex over the years. Propulsion motors, suspension systems, door operating mechanisms, air conditioning, and couplers are but a few of the mechanisms that have become more complicated and sophisticated. Thus, ATC equipment may produce reliability problems, not because of automation per se, but because it represents the introduction of one more complex piece of equipment in an already complex vehicle. The general rule of reliability is that as the number of interacting components increases, the overall reliability of the system decreases. The experience of NYCTA, which has no carborne ATC equipment, confirms this point.

ISSUE O-8: MAINTAINABILITY

To what extent does ATC equipment maintainability contribute to the general maintenance problems of transit systems?

ATC equipment is considered by transit managers to be a major maintenance problem, but probably no more so than other types of complex and sophisticated transit equipment. The problem of ATC maintenance is difficult to assess quantitatively because of the scarcity of detailed data and the variety of recordkeeping methods employed by transit systems.

Maintenance of transit system equipment is a never-ending battle. Weather conditions, hard daily use, and the demands of meeting train schedules all tax the ability of equipment to perform as required and increase the pressure to restore equipment to service when failures occur. The promptness with which maintenance is performed and the effectiveness of the repair action play a role almost as important as equipment reliability itself in sustaining the required level of service to transit system patrons. The overall importance of maintenance in the scheme of transit operations is illustrated by the fact that in most systems the maintenance force is equal to or larger than the force required to operate the trains. Maintenance of ATC equipment, because it is vital to the safety and efficiency of train operations, is of special concern.

The influence of ATC equipment maintainability on the general maintenance picture is hard to determine. Most transit systems do not keep

detailed and formal records that would allow the maintenance problems of ATC (or any other specific kind of equipment) to be analyzed and evaluated in precise quantitative terms. Shop logs, workmen's time records, and repair tickets are useful as working documents, but they do not lend themselves to treatment as a data base for calculating maintainability statistics such as mean time to restore (MTTR). The following observations, therefore, are based primarily on interviews with transit system maintenance personnel and constitute largely opinion and anecdotal evidence. This is supplemented with a small amount of data obtained from BART and PATCO, where detailed and quantitative maintenance records are kept.

The general feeling among transit system personnel is that ATC equipment poses especially difficult maintenance problems. Because this view is widely held by those intimately acquainted with the maintenance situation, it must be accepted. However, the data from PATCO, and perhaps BART also, do not entirely bear this out. This is not to deny that maintenance of ATC equipment requires substantial effort but simply to suggest that the size of the effort is not disproportionate in relation to that required for other types of transit system equipment of similar complexity and reliability. An examination of the data from PATCO will help to clarify this point.

Table 23 is a summary of maintenance time for several types of equipment in PATCO during a recent 16-week period. Maintenance time is expressed in terms of mean time to restore or repair (MTTR) and as a percentage of the total maintenance effort. For comparison, the frequency of failure for each type of equipment is also shown, expressed as the percentage of total failures,

In terms of both average repair time (MTTR) and proportion of the maintenance effort, ATC equipment is not significantly different from other types of equipment. MTTR is slightly over 3 hours for ATC, the same as for the master controller and only a few minutes longer than for the cam controller or motor generator. It is also significant that the time required for ATC repairs is in the same proportion to the total maintenance effort as ATC failures are to total equipment failures.

Interviews with maintenance personnel from other transit systems suggest, however, that the PATCO situation may not be typical. The experience in these other systems, notably older

TABLE 23.—Maintenance Time for Selected PATCO Car Components

COMPONENT	Number of Failures or Events	Total Repair Time (hours)	Average Repair Time (MTTR) (hours)	Percent of All Maintenance	Percent of All Failures
ATC	284	881	3.1	5.1	5.7
Air Brake	275	636	2.3	3.7	5.5
Cam Controller	288	803	2.8	4.6	5.8
Communication Controller	118	165	1.4	0.9	2.4
Controller	110	270	2.5	1.6	2.2
Coupler	424	582	1.4	3.3	8.5
Master Controllers	17	53	3.1	0.3	0.3
Motor-Generator	168	449	2.7	2.6	3.4
All Corrective Maintenance	5,005	12,007	2.4	69.0	—
Periodic Maintenance	1,213	5,387	4.4	31.0	—

¹Data are for a 16-week period, July 1–November 1, 1974.

²High voltage switches.

³Operator's control unit in cab.

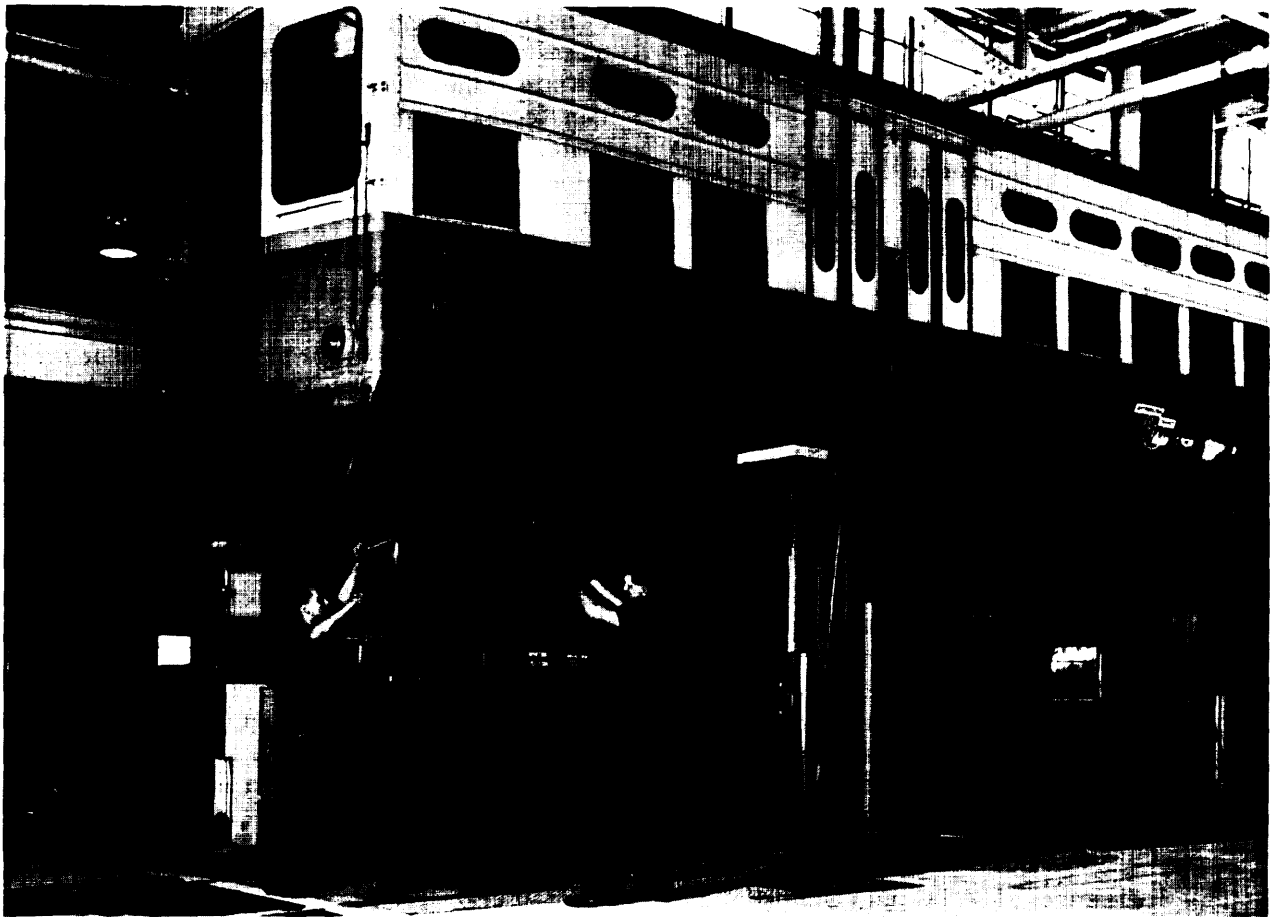

FIGURE 58.—Maintenance of Transit Vehicle Truck

systems converting to more automated forms of train control, indicates that ATC equipment takes longer to repair than other kinds of equipment. This is probably true if the comparison is made to conventional mechanical components. It could not be established how ATC repair time compares to that for other kinds of complex electronic equipment, in part because there is relatively little such equipment in use, except for radios and some elements of the propulsion control system.

Several reasons are cited by maintenance personnel to support this view that ATC equipment is difficult to maintain. Troubleshooting and fault isolation are more difficult procedures. It may take a substantial amount of time to confirm the train operator's report of trouble. Some kinds of failure are intermittent; others are difficult to reproduce under shop conditions. Also, the description of the malfunction reported by the operator may be erroneous or imprecise. Once the fault is diagnosed, the repair process may be time-consuming, both because of the type of work required and because of the need to check out additional secondary problems. A recurring problem in electronic maintenance in general, and ATC in particular, is the difficulty in ascertaining the effectiveness of the repair. This is the so-called repeating failure. In BART, for example, it is estimated that about one-third of the cars account for over two-thirds of the repairs; and a car delivered to the shop for a specific repair may be returned one or more times on successive days for the same reason. This has led some maintenance managers to the conclusion that realistic work planning must be based on the assumption that corrective maintenance for ATC equipment will be from 1.25 to 2 times the equipment failure rate,

It is widely agreed that the maintenance of electronic equipment, of which ATC equipment is a prime example, calls for a different type of maintenance skill than conventional transit system equipment. The human factor aspects of this problem will be treated later in a separate issue, but it should be noted here that the qualifications and experience of the shop force have a sizable influence on the success of ATC maintenance operations. Related problems are the shortage of qualified maintenance technicians and the more extensive training required to bring in new personnel or reassign the existing shop force. These manpower problems are especially keen in established transit systems going through a process of installing a new ATC equip-

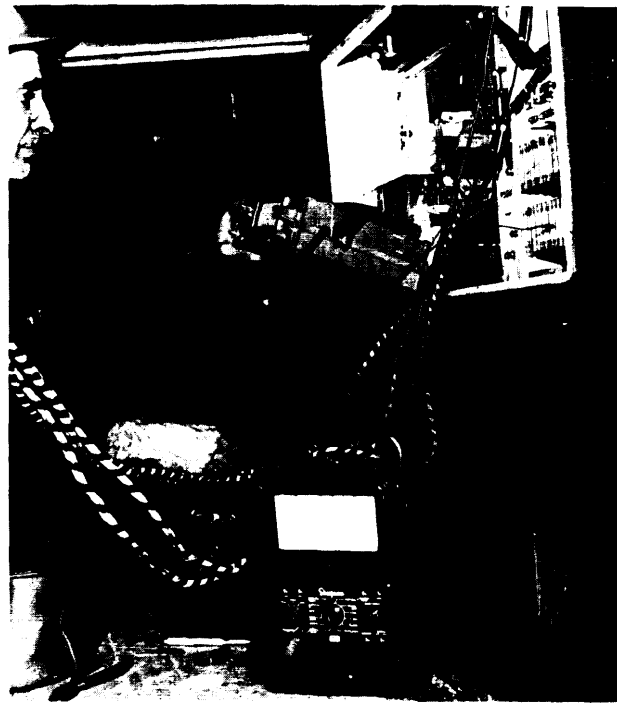

FIGURE 59.-Cab Signal Maintenance

ment or adding new lines. New systems tend to recognize these problems in advance and make provision to solve them in the preparatory period before inaugurating operations. Even so, this anticipatory action is not always successful, and new systems such as BART have had trouble in acquiring and training a suitable shop staff for electronic maintenance.

A related problem is that of facilities and shop equipment. The work space and tools required to maintain electronic equipment are very different from that of the conventional car shop. Most transit maintenance is dirty, heavy work that is largely mechanical. Electronic maintenance calls for a facility more like a laboratory or television repair shop. Special tools and test equipment are needed, and many transit systems have had to build such items themselves because of a lack of a suitable version on the general market. Older systems like CTA and MBTA have also had to build new maintenance facilities or remodel existing ones in response to the special needs arising from introduction of cab signals and related ATC equipment. But here again, the problem is not peculiar to ATC but stems from the more general trend in rail rapid transit to convert to a different form of technology.

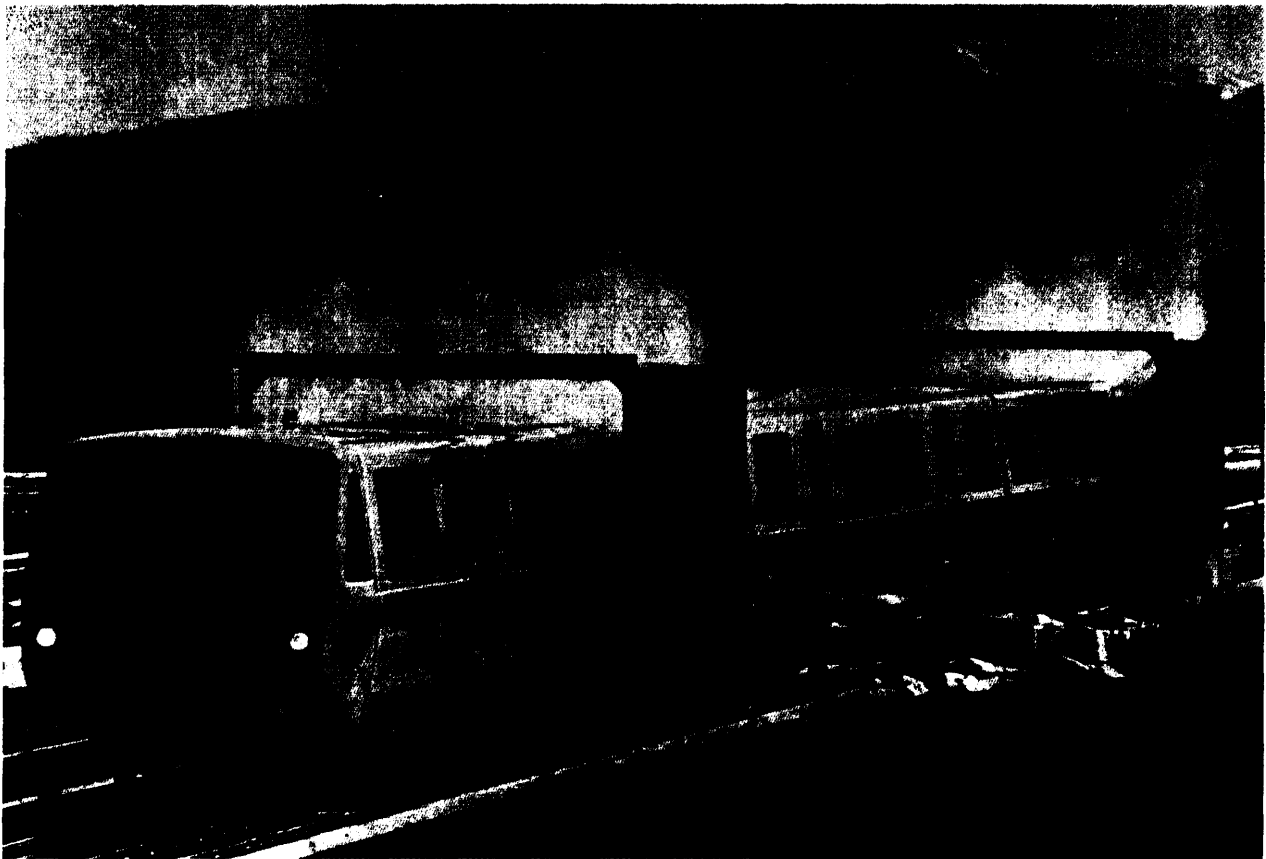

FIGURE 60.—Car Washer

As a final point, it should be noted that the design of ATC equipment and its placement on transit cars may aggravate the problems of maintenance. Access to equipment cases or individual components within them may be difficult; and the time to remove and replace an item may exceed repair time itself. In some instances, the equipment is not designed modularly so that defective elements can be quickly replaced and the car restored to service.

Repair of electronic equipment while it is in place on the vehicle is generally not an efficient maintenance strategy; but in many cases, the strategy of on-vehicle repair has been forced on maintenance personnel by a lack of spare parts. Nearly all transit maintenance and operating personnel interviewed during this study cited availability of spare parts as a major problem. Several factors seem to be at work here. First, there is the generally low reliability of new equipment; components are wearing out or becoming un-

serviceable at a much higher rate than anticipated. Second, there has been some instances of inadequate provisioning of spare parts in the initial procurement order. The lead time for replenishing stocks is often long, which tends to exacerbate the spare parts problem once it is detected. Third, some suppliers do not find it profitable to keep a supply of items that may be peculiar to a single transit system or to only a single procurement order by that system. Transit systems, old and new alike, have found it increasingly difficult to locate alternative sources of supply. The shortage of spare parts is not restricted to ATC equipment. It is a general problem in the transit industry, cited here to indicate all the factors that influence the maintainability of train control equipment,

The car availability problems that have plagued the BART system have received widespread attention in the transit industry and in the public at large. Equipment reliability, and often ATC system reliability, is cited as the major cause. Upon closer

examination, it appears that maintenance may also be an important part of the problem. A recent management audit of BART (Cresap et al., 1975) stated that maintenance was the prime problem to be solved by BART and recommended that approval for a full 20-hour, 7-day operating schedule be withheld until the maintenance backlog is cleared up and continued operation of the full 450-car fleet could be assured, Fig. 61 is a summary of the maintenance situation that existed in BART from May 1974 to January 1975, roughly the period during which the management audit was conducted. These findings are offered not in order to single out the BART system for special criticism but only to illustrate the impact that maintenance can have on car availability and transit system performance, In this regard, the categories of "Backlogged for Corrective Maintenance" and "Awaiting Parts" are particularly noteworthy, Estimates by BART officials indicate that ATC equipment maintenance makes up 10 to 20 percent of the total maintenance burden, a proportion roughly equivalent to the ratio of ATC failures to all equipment failures.

COST

The costs of automatic train control, both the initial capital cost to design and install ATC equipment and the cost to operate a transit system with ATC, raise several important issues,

In the area of capital cost, there is a need to examine the expense of acquiring an ATC system, in absolute terms and relative to the cost of the whole transit system. It is also important to examine the incremental capital costs associated with increasing the level of automation from a simple ATP system to one including ATO and ATS as well,

With regard to operational cost, the general issue is the comparative expenses of transit systems employing different levels of automation. Within this issue are specific questions relating to manpower and labor cost savings that may be derived from automation. There is also the question of energy savings that may be achieved by the more efficient train operation claimed to result from ATO and ATS,

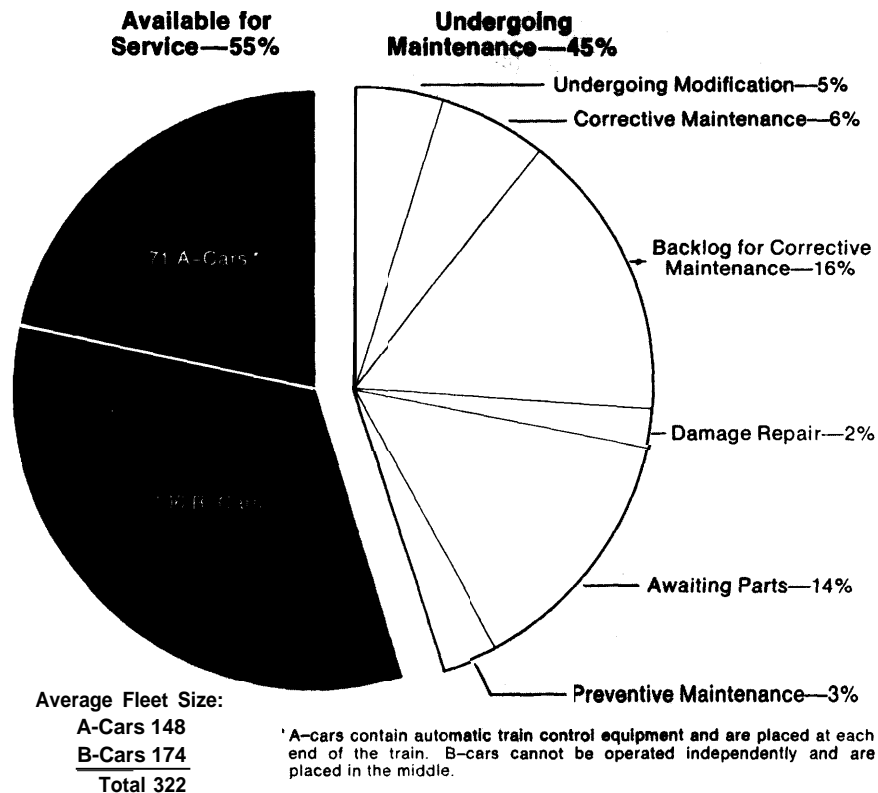

FIGURE 61.—Influence of Maintenance on Car Availability in BART, May 1974–January 1975

Ultimately, the matter of cost reduces the question of whether the greater expense required to acquire an ATC system can be recovered by operational savings over the life of the equipment. This matter is important, not just because of the public funds involved in capital grants and operating subsidies, but also because advocates of automation claim that ATC more than pays for itself in the long run,

ISSUE O-9: CAPITAL COSTS

What are the capital costs of automatic train control ?

ATC equipment costs are roughly 3 to 5 percent of the total capital costs for a rail rapid transit system. Ninety percent or more of the ATC cost is for wayside equipment.

The capital costs of an ATC system are influenced by a number of factors, primarily:

Level of Automation—the number of ATP, ATO, and ATS functions which are automated and the degree of operational sophistication (the number of running speeds, degree of supervisory control, or station stopping accuracy).

System Size and Configuration—miles of track, number of interlocking, number of stations and terminals, the number of trains or vehicles operated, and the nature of the train consist (i. e., A and B cars, married pairs, single-car trains, etc.),

Condition of Installation—installation as part of the original construction of the system or as an add-on to a system already in service. (The latter is generally more difficult and expensive.)

Customized Designs—the degree to which a specific ATC installation differs from other ATC designs in use within the system or elsewhere and the degree of custom engineering required to meet local requirements.⁶⁴

Table 24 is a summary of capital costs on transit systems recently built or now under construction. Because of the factors cited above and the effects of inflation, the costs of these systems cannot be directly compared. However, the data do indicate the general range of costs incurred in recent years by transit agencies building completely new systems with advanced levels of ATC.

⁶⁴One supplier of ATC equipment estimated that special engineering of just the speed regulation and station stopping equipment for a new installation can cost between \$100,000 and \$200,000.

TABLE 24.-Capital Costs in New Transit Systems

	PATCO	BART	WMATA	MARTA	MTA (Baltimore)
INITIAL SERVICE	1969	1972	1976	1979	1981
TOTAL SYSTEM					
Cost (\$ million)	1135	1,586	24,650	² 2,100	3450
Miles	14	71	98	50	¹ 15
Cost/Mi. (\$ million)	9.6	22.3	47.4	42	330
VEHICLES					
Cost (\$ million)	15	143	199	N A ⁴	N A ⁴
Number	75	450	556	338	N A ⁴
Cost/Vehicle (\$)	200,000	318,000	358,000	NA ⁴	N A ⁴
TRAIN CONTROL					
Automation Level ⁶	ATP, ATO	ATP, ATO, ATS	ATP, ATO, ATS	ATP, ATO, ATS	ATP, ATO, ATS
Cost (\$ million)	4.5	⁵ 40.5	³ 100	NA ⁴	² 5

¹Includes capital cost of new construction and equipment renovation, and estimated value of preexisting right-of-way, and structures

²Current estimate, cost by completion date will probably be higher.

³ Estimate for phase I, 15-mile partial system (1970 dollars).

⁴Not available.

⁵Includes additional work; original bid was \$26.2 million.

⁶ATS here means computer-aided Central control.

Since there are so many local and temporal factors at work, and because so few new systems have been built, historical data on procurements in such systems as PATCO, BART, and WMATA and projections for MARTA and MTA do not provide a meaningful picture of the capital cost of ATC. A different perspective is provided by Table 25, which contains estimated capital costs based on interviews with manufacturers and consultants concerning the current prices (1975 dollars) of major ATC system components.

Table 25 separates ATC equipment into two categories: carborne equipment and wayside equipment (including central control and ATS equipment). Within each category, successive levels of automation are identified and priced. The prevailing view in the transit industry today is that cab signals, overspeed protection, route interlocking, a modest supervisory system, and the associated communications equipment represent the minimum ATC system that will be installed. Thus, the first entries in the vehicle and wayside categories of table 25 should be considered a baseline system. Additional features incur additional costs as indicated.

To obtain an estimate of the total cost of a typical ATC installation, consider the example of a hypothetical transit system consisting of 50 miles of

double track (100 single-track miles) and zOO carborne controlled units (400 cars operating as married pairs with one ATC package per pair). The total cost of a baseline ATC installation (ATP only) in such a transit system would be approximately \$59.5 million (\$57.5 million for wayside and \$2 million for carborne equipment).⁶⁵ This would be a system with a level of automation roughly equivalent to the MBTA Red Line or the CTA West-South Line. The addition of ATO (the second entry in the wayside and carborne categories of table 25) would raise the cost to almost \$70 million (\$65 million wayside, \$4.5 million carborne). This would be a system resembling PATCO. The addition of ATS, to build a system with a level of automation similar to BART, would raise the capital cost to \$87 million (\$82.5 million wayside, \$4.5 million carborne). Note that the addition of ATS does not increase the cost of carborne ATC equipment since virtually all the additional equipment needed for ATS is in the central control facility.

While the absolute cost of an ATC system may be large, ranging up to \$100 million or more for a large system with a high level of automation, its

⁶⁵These estimates assume values for carborne and wayside equipment costs in the middle of the ranges given in table 25.

TABLE 25.—Cost Estimates for ATC Equipment

ELEMENT	UNIT OF MEASURE	APPROXIMATE UNIT COST
CARBORNE EQUIPMENT		
Cab signaling and overspeed protection	Controlled Unit ²	\$ 9,000-11,000
Above, plus speed maintaining, precision stopping, performance level adjustment, and train identification	Controlled Unit ²	18,000-25,000
WAYSIDE EQUIPMENT		
Cab signaling, overspeed protection, route interlocking, data transmission, modest supervisory system	Single-Track Mile	500,000-650,000
Above, plus precision stopping, performance level adjustment, and train identification	Single-Track Mile	550,000 -750! 000
Above, plus sophisticated ATS with computerized control	Single-Track Mile	750,000-900,000

¹1975 dollars

²A controlled unit may be more than one vehicle. e.g., a married pair of cars typically has only one set of ATC equipment.

(SOURCE: Battelle from manufacturer and consultant interviews.)

cost relative to the total capital cost of the system is low. A rail rapid transit system typically costs \$30 million to \$45 million per double-track mile to build. Transit vehicles cost in the range of \$200,000 to \$350,000 each, depending upon their size and complexity. On this basis, wayside ATC equipment represents something on the order to 3 to 6 percent of the cost per track mile. Carborne ATC accounts for 5 to 12 percent of vehicle cost.

Returning to the example of the hypothetical system, the total cost would be about \$2 billion.⁶⁶ The ATC system, depending upon the level of automation selected, would run between \$60 million and \$87 million, or 3 to 5 percent of the total capital cost. Note that the cost increment associated

⁶⁶(50 double-track miles X \$35 million per mile) + (400 cars, i.e., 200 married pairs, x \$300,000) = \$1.88 billion + \$0.12 billion = \$2 billion.



Section of BART Transbay Tube



BART Elevated Guideway



WMATA Pentagon Station

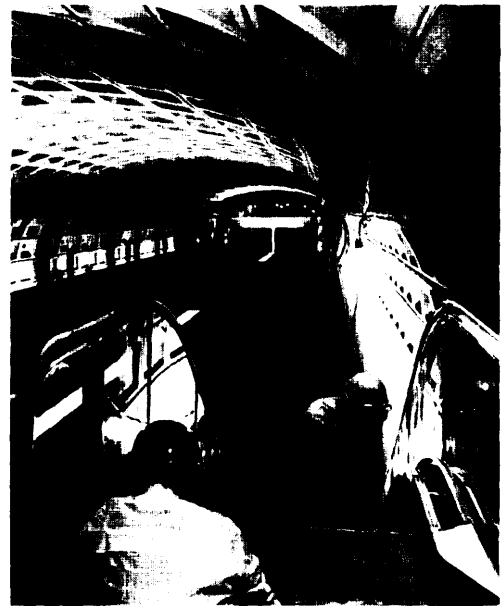

WMATA Judiciary Square Station

FIGURE 62.—Transit System Construction

with selection of an ATC system with a high level of automation instead of a baseline system with ATP alone, would amount to only 2 percent or so of the total capital cost of the transit system. Note also that the bulk of the expense, either for a baseline or a highly automated ATC system, lies in wayside equipment—90 percent or more.

ISSUE 0-10: OPERATIONAL COST

How do the operating costs of systems with automatic train operation compare to those of systems where trains are run manually?

The costs of operating trains are somewhat lower in systems with ATO, but the maintenance costs are higher. In general, ATO reduces the proportion of personnel-related costs in operating a transit system.

One of the purported advantages of automatic train control (particularly automatic train operation) is that it can reduce the operating costs of a transit system. This reduction would be brought about primarily by decreasing the number of personnel needed to operate the system. The question of workforce reduction is thus a pivotal issue that needs to be examined from several aspects. The purpose here is to look at operating cost in general terms to provide a background for the specific discussions of workforce reduction in the two following issues.

Table 26 is an analysis of operating costs for the most recent year in five transit systems. Since these systems vary greatly in size and service level, the data are normalized by expressing cost in terms of dollars per revenue car mile and as percentages of total operating expenses for each system. Costs are allocated to three categories: transportation, maintenance, and administration. The transportation category includes all costs incurred in providing passenger service. Payroll and fringe benefits for train crews, central control personnel, station attendants, and supervisors are the largest components; but the category also includes electric power costs and all other expenses associated with transit operations.⁶⁷ Maintenance includes all personnel-related costs for vehicle, track, signal, and structures maintenance as well as the cost of material and supplies. Administration is made up of all expenses associated with management, support, and administrative services and all general expenses not directly attributable to either transit operations or maintenance.

The five systems are arrayed in an order that represents an increasing level of automation, from left to right, but the principal distinction is between NYCTA, CTA, and MBTA with conductors on the trains and PATCO and BART without. Note, however, that technology is not the only factor determining the size of the train crew, Local labor

⁶⁷Transit police expenses have been excluded since not all systems have an internal police force.

TABLE 26.—Summary of Rail Rapid Transit Operating Costs

	NYCTA (1973/74)	CTA (1974)	MBTA (1974)	PATCO (1974)	BART (1974/75)
OPERATING COST (\$/revenue car mile)					
Transportation	1.05	0.95	2.15	0.72	0.89
Maintenance	0.62	0.44	1.45	0.59	11.33
Administration	0.26	0.15	1.22	0.16	0.30
Total	1.93	1.54	4.82	1.47	12.52
PERCENT OF OPERATING COST					
Transportation	55	62	45	49	36
Maintenance	32	29	30	40	52
Administration	13	9	25	11	12
RATIO OF MAINTENANCE COST TO TRANSPORTATION COST	0.59	0.44	0.68	0.82	1.48
SALARIES, WAGES & BENEFITS AS PERCENT- AGE OF OPERATING COST	82	82	80	64	74

I For stable year operation, BART forecasts a maintenance cost of about \$0.83 per revenue car mile, with transportation and administrative expenses remaining at present levels. If the reduction of maintenance is achieved, the total cost per revenue car mile would be \$2.02 and the maintenance-transportation cost ratio would be 0.93.

agreements and operating philosophy also play strong roles. Thus, any cost differences among these systems are not purely the result of train control automation.

Examination of the revenue costs per car mile reveals a wide variation among the five systems," with no clear-cut pattern. PATCO, a system with ATO and a single train operator, has the lowest overall operating cost;⁶⁸ but BART, which is equally automated in the area of ATO, has costs substantially higher than any system except MBTA.

⁶⁸The PATCO figures are somewhat deflated in the area of transportation and administration. PATCO stations are largely unattended, while all the other systems have station attendants. Many administrative functions normally carried out by a transit agency are, in the case of PATCO, accomplished by its parent organization, the Delaware River Port Authority. If allowance is made for these factors, the transportation-related costs of PATCO might be on the order of 80 to 85 cents per revenue car mile and the administrative costs 20 to 25 cents per revenue car mile.

Nevertheless, it does appear that transportation costs are lowest in the two systems with ATO. It also appears that maintenance costs are somewhat higher than in systems with manually operated trains. In the case of BART, this is probably a reflection of the general maintenance problems that have plagued the system and not a specific effect of ATO.

The reciprocal relationship of maintenance and transportation costs appears most pronounced when they are expressed as percentages of the total operating cost of the respective systems. As the proportion of transportation costs goes down, the maintenance proportion rises; and the sum of the two is a roughly constant 80–90 percent of the whole.⁶⁹ The tendency of the relative cost of maintenance to in-

⁶⁹This generalization does not hold true for MBTA, where the percentage of administrative costs is unusually high and where absolute costs are about double those of any other system,

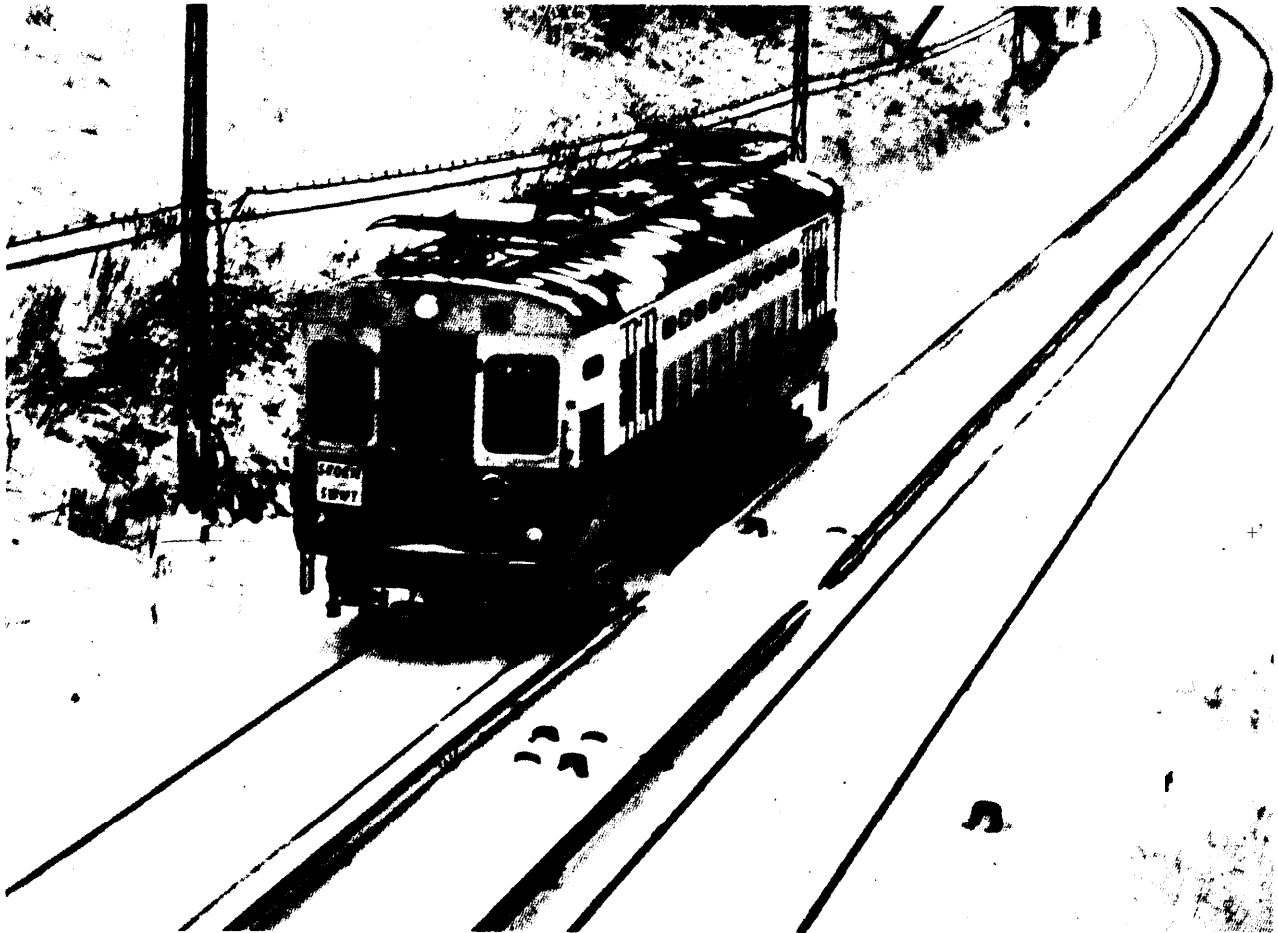

FIGURE 63.—Winter on the Skokie Swift Line

crease as a function of automation also appears when maintenance cost is expressed as a ratio of transportation cost.

Another apparent, and logically expected, effect of automatic train operation is the lower proportion of payroll-related costs in PATCO and BART. Labor accounts for 80 to 82 percent of operating cost in the systems with manually operated trains and two- or three-man crews. In PATCO, labor costs are only about two-thirds of total cost—partly due to one-man operation and partly due to the absence of station attendants. In BART, the percentage is higher, although still lower than NYCTA, CTA, and MBTA. BART officials forecast that the labor component will drop to something like 65 to 70 percent when the debugging period is passed and the maintenance situation becomes more normal.

While some of these observed differences undoubtedly arise from causes not related to automation, it does appear that ATO (insofar as it leads to a reduction of train-crew size) has the effect of lowering labor cost and, perhaps, overall operating expense. This conclusion must remain tentative at this point because the data are limited to such a few cases. However, it deserves further examination in the following issues, which deal more specifically with the manpower effects of ATO,

ISSUE 0-11: WORKFORCE REDUCTION

Does automatic train control lead to a reduction of the workforce?

Automation of train operation functions, permitting reduction to a one-man train crew, leads to small but significant workforce savings. Further automation, but short of total automation, has little effect.

As a concept, automation implies the replacement of human labor with machines. In some cases, automation results simply in lessening the workload for operating personnel without changing the manning level of the system. In other cases, it may be possible to replace a human operator altogether—either by assigning all functions to machines or by consolidating several partially automated functions into a smaller number of operator positions. The potential economic advantages of automation are large. Rapid transit is a labor-inten-

sive system, in which personnel costs (salaries and benefits) typically account for 65 to 85 cents of every dollar of operating expense. Clearly, even a small manpower reduction of 10–15 percent would have enormous leverage and might make the difference between an operating deficit and breaking even,

Historically, rail rapid transit has pursued a course of consolidation by successively reducing the number of conductors in the train crew. In the early days, conductors were assigned to each car or pair of cars to collect fares and operate the doors. As fare collection was transferred to stations and as semiautomatic and power-assisted door mechanisms were introduced, the conductor workforce was reduced to one per train, with even greater relative reductions brought about by running longer trains. In newer systems such as PATCO and BART, the conductor has been eliminated altogether, and the door operation function has been transferred to the train operator (PATCO) or automated entirely (BART). The ultimate step is a fully automated system like AIRTRANS, which operates unmanned vehicles.

Table 27 shows the general effect on the workforce produced by various levels of ATC. Representative transit systems are listed by increasing level of automation. Because these transit systems vary greatly in size and organizational structure, the data have been normalized by expressing workforce as the ratio of operations and maintenance personnel to vehicles. Personnel responsible for administrative, support, planning, developmental engineering, station operation, station maintenance and police activities are excluded in order to confine the comparison to the area most directly affected by ATC.

For MBTA, NYCTA, and CTA, where automation is the least and the train crew is two or three, the employee/vehicle ratio is between 3.1 and 2.4. In PATCO, where ATO has permitted reduction of the train crew to one, the ratio is lower than in MBTA and NYCTA but higher than in CTA. The PATCO ratio might be lower if PATCO were more nearly the same size as the others. There are undoubtedly economies of scale in a large organization that cannot be obtained in a transit property with only 75 vehicles and 203 operations and maintenance employees.

The more advanced level of automation represented by BART does not result in a manpower

TABLE 27.—Effect of Automation on Size of Workforce

SYSTEM I	TRAIN CREW	O&M EMPLOYEES	TRANSIT VEHICLES	EMPLOYEES PER VEHICLE
MBTA	2-3	1,063	354	3.0
NYCTA	2	21,045	6,681	3.1
CTA	2	2,594	1,094	2.4
PATCO	1	203	75	2.7
HART (1974/75)	1	1,000	350	2.9
BART (Stable Year) ¹	1	1,192	450	2.6
AIRTRANS (1974)	0	142	68	2.1
AIRTRANS (Stable Year) ⁴	0	122	68	1.8

¹All data are for the most recently completed operational year.

²Includes only personnel to operate and maintain trains, with immediate supervisors.

³Train crew consists of motorman and one train guard for each pair of cars,

⁴After debugging and transition to full operational status.

reduction, BART at present has an employee/vehicle ratio about equal to MBTA or NYCTA. In projected stable-year operation, the ratio will decline to a level comparable to that of PATCO. The reason for the rather high rate in BART at present is apparently connected to the problem of equipment reliability, which necessitates a large maintenance force. Further examination of this point will be deferred to the next issue, where the composition of the workforce in BART and other systems will be analyzed,

The employee/vehicle ratio for AIRTRANS, a fully automated system with unmanned vehicles, is about the same as PATCO, where there is a one-man train crew, AIRTRANS is, however, a new system still undergoing operational shakedown. The present operating force includes 36 passenger-service employees required to help patrons find their way around the airport. It is anticipated that the need for such employees will decrease once better signing has been installed. It is also expected that the maintenance force will be reduced as debugging and break-in of the equipment is completed and more operating experience is gained. It is anticipated that the total of O&M employees would go down to about 122 in a stable year, producing an employee/vehicle ratio of 1.8, a figure substantially lower than that of any manned system,

From these data it appears that ATO, insofar as it allows consolidation of conductor and motorman functions in a single train operator position, will

produce a small but significant manpower saving.⁷⁰ Automation to levels beyond the minimum required for such consolidation, but short of full automation, does not seem to lead to further manpower savings because of offsetting increases in the required maintenance force,

ISSUE 0-12: WORKFORCE DISTRIBUTION

What effect does automatic train control have on the composition and distribution of the workforce ?

As the degree of automation increases, the number of operation employees goes down, but the number of maintenance employees goes up. The net result is a shift in the balance of the workforce without a substantial decrease in the total O&M force.

⁷⁰Transit system professionals point out that automation is only one factor influencing the size of the train crew. Union agreements and work rules, especially in established transit systems, may play a part in keeping the conductor on the train even though the train could be satisfactorily operated by one person at the existing level of automation. In some circumstances, transit system management officials may also conclude that the conductor position should be retained for reason of passenger safety in emergencies or as a way of offering information and other assistance to patrons on long trains.



CTA Train With Conductor



BART Train Without Conductor

FIGURE 64.—Reduction of Train Crew

In the discussion of the preceding issue, it was concluded that automatic train operation (ATO), insofar as it permits reducing the train crew to one, produces a small decrease in the total O&M workforce. This decrease, however, is not commensurate with the number of conductor positions eliminated. It is therefore necessary to examine the composition and distribution of the workforce at various levels of automation to see what countervailing effects are at work.

Figure 65 shows the relative size of the operations and maintenance forces in five transit systems. To illustrate the effect of full automation (i.e., elimination of all on-board personnel), similar figures are also given for AIRTRANS, even though it is not a true rail rapid transit system. Operations employees are all those necessary to operate trains—dispatchers, trainmasters, stationmasters, towermen, central controllers, and yard motormen as well as the train crew itself. Maintenance personnel include the employees in car shops, and those needed to maintain way, power, and signals. The size of the operations and maintenance forces is expressed as a percentage of all employees for the respective transit systems.⁷¹

While there is considerable variation in the data, there does appear to be a discernible trend. Reading from top to bottom, as train operation generally becomes more automated, the proportion of operations employees declines while the proportion of maintenance employees shows a corresponding increase. It appears that ATO results primarily in a shift of the balance of the O&M workforce but without significantly changing its size in relation to the total workforce. More specifically, as conductors and finally the operator are taken off the train, almost equal numbers of new jobs are created in the car shops and wayside maintenance crews.

A more detailed analysis is presented in table 28, where the workforce in the operations and maintenance departments is expressed in terms of the number of employees per car. The number of operations employees per car generally declines from 1.2–1.4 for systems with manual train operation and a crew of two (NYCTA, CTA, and MBTA) to 0.3 for a fully automated system (AIRTRANS). PATCO and BART, with a train crew of one, fall about midway between. At the same time, the maintenance force increases from 0.8 per car in CTA to 1.8–2.0 for BART and AIRTRANS in the current year.⁷² The same trend shows up even more clearly in the ratio of maintenance to operations employees, where there is a threefold to tenfold difference between manned systems without ATO (NYCTA and CTA) and the unmanned AIRTRANS system, with PATCO and BART falling at roughly proportional intermediate points.

⁷¹Transit police and construction personnel are excluded.

⁷²Estimates of stable year operations for both systems project a decrease in the ratio of maintenance employees per car to 1.5–1.7, a figure comparable to PATCO.

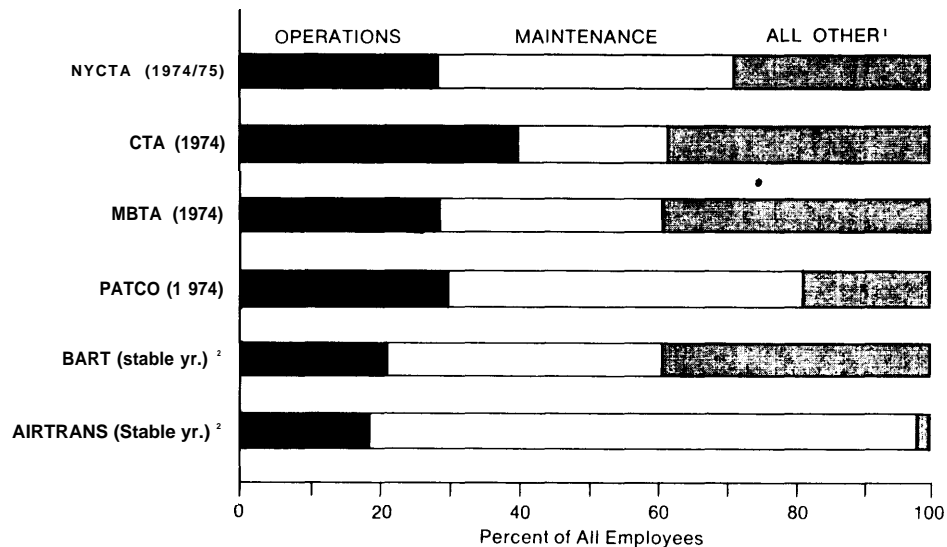

1. Excludes transit police and construction personnel
 2. Estimated staffing when debugging is completed and the system becomes fully operational

FIGURE 65.—Proportion of Operations and Maintenance Employees in Total Workforce

TABLE 28.—Analysis of Operations and Maintenance Workforce

	NYCTA (1974/75)	CTA (1974)	MBTA (1974)	PATCO (1974)	BART		AIRTRANS	
					74/75	S.Y. ¹	74	S.Y. ¹
Total Cars in Fleet	6,681	1,094	354	75	350	450	68	68
O&M Employees	21,045	2,370	1,063	203	1,000	1,192	142	122
Operations Employees	8,350	1,540	482	75	315	415	22	22
Maintenance Employees	12,695	830	581	128	684	777	120	100
O&M Empl./Car	3.1	2.2	3.0	2.7	2.9	2.6	2.1	1.8
Ops. Empl./Car	1.2	1.4	1.4	1.0	0.9	0.9	0.3	0.3
Maint. Empl./Car	1.9	0.8	1.6	1.7	2.0	1.7	1.8	1.5
Maint. Empl./Opr. Empl.	1.5	0.5	1.2	1.7	2.2	1.9	5.5	4.5

¹Estimated stable year operation.

²Traincrew, dispatchers, towermen, central control, and yard motormen.

³Maintenance of vehicles, way, power, and signals.

The differences among these systems are not solely attributable to ATC. A large share of the maintenance force (67–93 percent) is not concerned with ATC equipment but with other carborne and wayside components, which also tend to need more maintenance as the transit system becomes more complex or equipment and structures grow older. Still, the percentage of maintenance employees involved in ATC-related activities shows a general increase proportionate to the level of automation.

In NYCTA, with no carborne ATO equipment and all ATP in the wayside, it is estimated that 10 percent of the maintenance force performs ATC-related work (primarily signal maintenance). The estimated figure for CTA is about 5 percent, about half for wayside equipment and half for cab signals. For MBTA the figure is now 7 percent, but expected to increase as cab signals are installed on other lines. PATCO, with cabs-signaled ATP and ATO, has about 15 percent of the maintenance force dedi-

cated to ATC (9 percent wayside, 6 percent cars). For BART, the ATC position of the maintenance force is now about 31 percent (18 percent for wayside and central ATS equipment, 13 percent for cars)--a distribution that is expected to remain essentially the same when stable-year operation is attained. From these data, it appears that the progression from ATP (either wayside or cab signals) to ATP and ATO results in a doubling of the percentage of the maintenance force assigned to ATC activities. The increase to a system with ATP, ATO, and ATS (if BART is typical) causes the percentage to double again.

If the PATCO and BART cases are assumed to be representative of the manpower shifts that result from automation of the train control system, it is possible to draw some tentative conclusions about cost savings attributable to ATC. For PATCO, the incorporation of ATO made it possible to run the trains with a single operator, resulting in the elimination of about 45 conductor positions. At the same time, about 15 additional shop and wayside

personnel were required to maintain ATC equipment. This is a net of 30 fewer employees. However, the pay rate for personnel skilled in ATC maintenance is generally higher than that for conductors. Assuming a pay differential of 20 percent for ATC maintenance workers, the effective saving in payroll costs reduces to about 25 positions, or roughly 9 percent of the annual payroll. Following a similar line of reasoning, the BART ATC system eliminated the need for about 315 conductors, but added about 200 to the maintenance force, a net of 115 fewer positions.⁷³ Adjusting for maintenance pay differential, this is equivalent to a saving of about 75 positions, or roughly 4 percent of the annual payroll. Since labor costs are about three-quarters of all system operating costs, these calculations suggest that automatic train operation with a crew of one offers the potential to reduce operating costs somewhere between 3 and 6 percent per year.

⁷³The BART estimate assumes stable-year staffing levels.

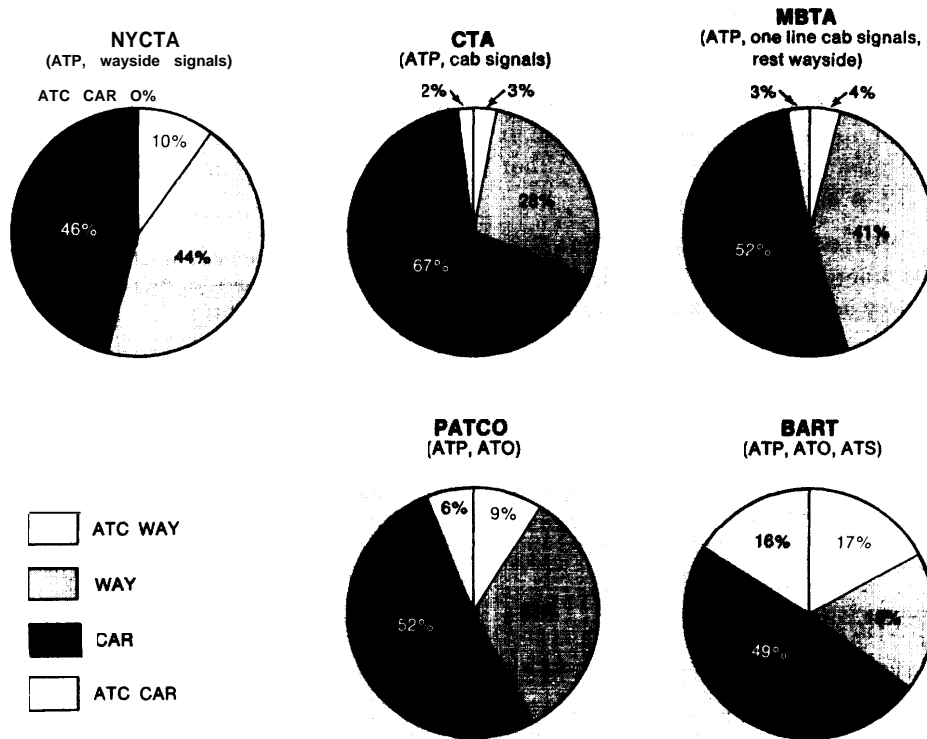

FIGURE 66.—Distribution of Maintenance Force as a Function of Automation

ISSUE 6-19: ENERGY COST

Does ATC result in any energy savings in transit operations?

Electric power consumption rates for systems with and without ATC do not show any differences attributable to the mode of train control. If there are any energy savings due to ATC, they are probably so small as to be overwhelmed by other operational factors such as speed and the power-weight ratio of vehicles.

One of the arguments often advanced for automatic train control is that ATO and ATS can lead to a more efficient mode of train operation and, hence, lower energy consumption. It is asserted that, in an automatic system, trains can be run at more uniform headways and at predetermined speed-distance patterns, which provide lower maximum speeds and more uniform accelerating and braking rates. This yields a lower power consumption per car mile as a direct effect. The more uniform spacing of trains brought about by operating at optimum conditions also has an equalizing effect on the passenger load of trains, and in turn produces more energy savings as a secondary benefit. More uniform headways also shorten layover times at terminals, permitting a reduction in the number of trains operated and still further energy savings. (Irvin and Asmus, 1968)

Theoretically, this argument is sound; but it is difficult to test its practical validity and to assess the magnitude of energy savings that might actually be

achieved in revenue operations with various forms of ATC. Table 29 is a summary of the energy consumption in the five transit systems considered in this study. Energy usage is expressed in terms of kilowatt-hours per revenue car mile and per passenger mile. The latter figure is perhaps the better index for comparing energy consumption among the five systems because it is independent of vehicle seating capacity and load factor.

Note that the power consumption figures are systemwide totals, including traction power and all other uses such as vehicle lighting and air conditioning, station operation (lighting, escalators, etc.), parking lots, and maintenance facilities. A purer form of comparison would be the energy required for traction power alone, but such figures could not be accurately derived from the records of some systems. Thus, there is some distortion of the data due to factors other than train operation, but their influence is probably not large since traction power represents the dominant share of all energy use (typically three-quarters or more) .74

The data in table 29 do not indicate differences among transit systems that appear to be related to ATC. With the exception of CTA, the energy consumption per passenger mile is about the same for all systems, regardless of the level of automation. In short, there is no conclusive evidence that ATC saves energy, at least when energy use is measured at the overall system level.

⁷⁴In BART, for example, traction power amounts to about 75 percent of all power use. In PATCO, traction power is 85 to 90 percent of the total.

TABLE 29.—Rail Rapid Transit Energy Consumption

ENERGY CONSUMPTION	NYCTA (1973/74)	CTA (1974)	MBTA (1974)	PATCO (1974)	BART ² (1974/75)
ANNUAL KILOWATT-HOURS (million)	2055.0	256.2	102.4	39.3	197.9
ANNUAL REVENUE CAR MILES (million)	320.6	46.8	10.3	4.3	21.6
ANNUAL PASSENGER MILES (million)	35480.0	775.2	³ 263.2	95.0	446.4
KWH/REV. CAR MILE	6.4	5.2	9.9	9.2	9.2
KWH/PASSENGER MILE	0.38	0.33	0.39	0.41	0.44

¹Power consumed for all purposes (traction, station operation, shops, etc.).

²Estimate based on operating data for July 1974 to January 1975.

³Estimate based on average trip length of 5 miles.

⁴Estimate based on average trip length of 3.1 miles.

There may indeed be energy savings due to ATC, but they cannot be discerned by the methods employed here. In all probability they are small and masked by several other factors which account for most of the observed differences among the five systems. For example, these transit systems differ greatly in their maximum operating speed and average line speed. The two systems with ATO (PATCO and BART) also happen to run trains at higher speeds. Since power consumption varies directly as a function of speed, the possible energy savings due to ATC in PATCO and BART are probably offset by the increased energy required to run trains at 70–75 mph.

The weight of the vehicle has a profound effect on the amount of traction power required to move trains. There is great variation among transit systems in the weight of vehicles, and this factor alone probably accounts for most of the difference in power consumption. In this regard, it is significant that CTA (with 20- to 24-ton cars) has the lowest level of energy use and PATCO (39-ton cars) has one of the highest.

It should also be noted that several other factors influence power consumption. Among these are the aerodynamic properties of vehicles⁷⁵, route charac-

⁷⁵The amount of aerodynamic resistance to be overcome varies according to whether the train is operating in a tunnel, on elevated structure, at grade, or in a cut.

teristics, the steepness of grades, and station spacing. Any one of these factors is probably sufficient to counterbalance any energy conservation that might be attainable through ATC. Collectively, they confound the picture of energy use in operating transit systems to such a degree that ATC-related benefits, if any, are impossible to isolate.

HUMAN FACTORS

Man, as operator and supervisor, has traditionally played a vital part in rail rapid transit train control systems. The train crew, tower operators, dispatchers, and central supervisory personnel of a conventional, manually operated transit system make up a highly skilled team, whose functions are to assure the safety and efficiency of passenger service. As specific tasks, formerly carried out manually, are assigned to automatic components, the human role is diminished quantitatively—in the sense that there is less work for man to do. At the same time, however, the place of humans in the system acquires even greater importance in some respects. The tasks remaining for man in transit systems with ATP, ATO, and ATS are generally those that are considered either impractical to automate or so vital to system operation that human attention is mandatory. This suggests that, along with the diminishing of workload that comes with automation, there comes a qualitative change in the role of man. While certain vital functions are re-



FIGURE 67.—State-of-the-Art Car

tained by man, he becomes less an operational element of the system and more a monitor, overseer, and back-up for automatic elements, which themselves carry out the direct functions of train control.

Up to this point in the discussion of operational experience with ATC, automation has been treated primarily in terms of machine performance and engineering concerns. To complete the picture, it is now necessary to examine the inverse subjects of the role of man and the effects that automation produces upon the humans who, perforce, remain an integral part of the train control system. There are two major questions here. First, there is the need to examine whether man is used effectively and prudently in systems with various levels of ATC. What use is made of man's performance capabilities? Is adequate attention given to human needs as operator and supervisor? Is man well integrated into the system? The second major concern is the consequences that have resulted from the application of automation in transit systems. Specific matters of interest are changes in working conditions and job qualifications for transit system employees and the secondary effects that ATC may produce for the riding public using the transit system,

ISSUE O-14: THE HUMAN ROLE

Is effective use made of man in systems with ATC?

In some cases, new transit systems with ATC do not make effective use of the human operator to back up or enhance automatic system performance, and human involvement in normally automatic processes tends to degrade performance, primarily in terms of speed, headway, and level of service. In systems now under development, there **seems to be a greater concern for the role of man and for making the ATC system more amenable to human intervention.**

In considering the role of humans in systems with automatic train control, it is necessary to distinguish among the parts played by man in each of the major functional categories: train protection, train operation, train supervision, and communication.

In train protection (ATP), the motormen (and conductors, if there are any) customarily perform

very few functions, except in a back-up or emergency capacity. Nearly all transit systems have either wayside or cab signal equipment that automatically assures train separation and prevents overspeed. The human operator's tasks are track surveillance (for detecting persons and obstacles on the right-of-way or as a back-up to track circuits for detecting other trains) and emergency braking in unusual circumstances that the ATP system is not designed to detect. The operator also acts to restore the system to operation in the event of ATP system failure, performing such tasks as emergency brake release, key-by, or manual route request. Since the operator is backing up a highly reliable system, there are significant problems in maintaining proper vigilance and alertness. There is also considerable risk of human error in cases where the ATP system is not functioning properly or has been deliberately bypassed (as when closing in on a disabled train).



FIGURE 68.—Student Conductors Training on the Job

In the area of train operation (ATO) there is wide variation among transit systems in the tasks assigned to the on-board operator. In NYCTA, CTA, and MBTA (except the Red line) all train operation functions are performed manually. In PATCO, only door operation and train starting are manual in normal circumstances. In BART, all train operation is automatic. The role of the on-board operator in systems with ATO is mainly limited to

monitoring automatic equipment performance, acting as a back-up in the event of malfunction or emergency, and—in some cases—adjusting the performance level of the ATO system (e.g., by modifying speed-acceleration profiles or by ordering the train to run by a station without stopping). The major human performance problems that have been encountered in regard to ATO are the effectiveness (and safety) of manual intervention in normally automated processes and the adequacy of the controls and displays provided to the operator for purposes of monitoring or manual takeover.



FIGURE 69.—Motorman at Work

Train supervision embraces a number of diverse functions, mostly carried out at a remote, centrally located facility. Here, too, there is wide variation among transit systems in the degree of automation. At one extreme virtually all functions except train dispatching are manual operations. At the other extreme, scheduling, dispatching, route selection, traffic regulation, and documentation of events are carried out by automatic devices either wholly or primarily. Because the supervisory facility is the nerve center of the transit system, there can be significant workload problems for supervisory personnel, particularly during rush hours or emergency situations. These problems may be aggravated in systems with ATS if there is a breakdown of automatic equipment or the need for extensive human intervention in response to unusual conditions to which the computers are not programmed to respond. The major difficulties that have been encountered in systems with ATS are the quality and timeliness of information available to central control personnel, the flexibility of automatic system response in abnormal or emergency conditions, and the ability of humans to assume the burden of making and implementing decisions in areas normally assigned to machines.

While there has been some automation of the communication process in the newer transit systems, primarily in the area of data transmission, the major thrust of technological innovation has been to provide train crews and central supervisors

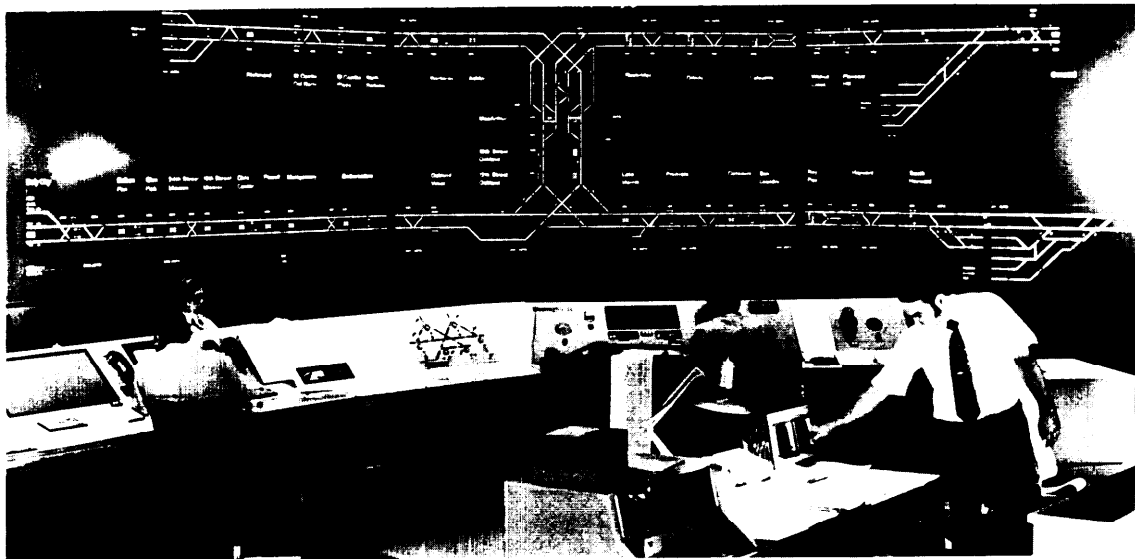

FIGURE 70.—Line Supervisors

with more extensive means of voice communication. The major problems encountered have been how to manage communication networks of increased size and complexity, how to limit unnecessary or excessive exchanges (chatter), and how to implement various modes of selective and general address. There has also been a general concern about the ability of improved communication systems to compensate for the fewer number of on-board personnel in providing information and instructions to passengers in special or emergency situations and in affording passengers a way of

communicating with remotely located transit system employees.

Table 30 is a summary of the allocation of tasks to men and machines in several operating and developmental transit systems. The table also indicates man-machine allocations in AIRTRANS which, although not a true rail rapid transit system, may be considered representative of the extent that present technology can go in achieving a fully automated train control system. The systems have been arrayed in a generally increasing order of automa-

TABLE 30.—Man and Machine Roles in Rail Rapid Transit Systems

KEY: A = Automated M = Manual — = Not provided		Track Surveillance (ATP)	Train Separation (ATP)	Route Interlocking (ATP)	Overspeed Protection (ATP)	Velocity Regulation (ATO)	Station Stopping (ATO)	Door Monitoring and Control (ATO)	Performance Level Modification (ATO/ATS)	Train Dispatching (ATS)	Schedule Monitoring & Adjustment (ATS)
TRANSIT SYSTEM	SITUATION										
NYCTA	Normal	M	A	A	A	M	M	M	M	A	M
	Abnormal ¹	M	A	A	A	M	M	M	M	M	M
	Emergency ²	M	M	AIM	AIM	M	M	M	—	M	M
CTA	Normal	M	A	A	A	M	M	M	M	A	M
	Abnormal	M	A	A	A	M	M	M	M	M	M
	Emergency	M	M	AIM	A/M	M	M	M	—	M	M
MBTA ³	Normal	M	A	A	A	A	M	M	M	A	M
	Abnormal	M	A	A	A	A	M	M	M	M	M
	Emergency	M	M	A/M	AIM	M	M	M	—	M	M
PATCO	Normal	M	A	A	A	A	A	M	M	A	M
	Abnormal	M	A	A	A	M	M	M	M	M	M
	Emergency	M	M	AIM	AIM	M	M	M	—	M	M
MTA ⁴ (Baltimore)	Normal	M	A	A	A	A	A	M	M	A	A
	Abnormal	M	A	A	A	A/M	AIM	M	M	M	M
	Emergency	M	M	A/M	AIM	M	M	M	—	M	M
WMATA ⁴	Normal	M	A	A	A	A	A	A	A	A	A
	Abnormal	M	A	A	A	AIM	AIM	AIM	A	A	A
	Emergency	M	M	AIM	AIM	M	M	M	—	M	M
MARTA ⁴	Normal	M	A	A	A	A	A	A	A	A	A
	Abnormal	M	A	A	A	A	A	M	AIM	A/M	AIM
	Emergency	M	M	AIM	AIM	M	M	M	—	M	M
BART	Normal	M	A	A	A	A	A	A	A	A	A
	Abnormal	M	A	A	A	A	A	AIM	A	A	A
	Emergency	M	M	AIM	A/M	M	M	M	—	M	M
AIRTRANS	Normal	—	A	A	A	A	A	A	A	A	A
	Abnormal	—	A	A	A	A	A	—	A	A	A
	Emergency	M	AIM	AIM	A/M	M	M	M	—	M	M

¹Moderate delays, bad weather, unusually heavy demand

²Major delays, accidents, failure of critical equipment.

³Red Line only.

⁴Under development, not yet operational.

tion to facilitate seeing the overall pattern of replacement of the human operator by automated devices,

It can be seen that the general effect of increased automation is for machines to assume a greater and greater share of operational functions in normal situations and in certain off-normal conditions, but not in emergency conditions. At every level of automation, man remains the primary means of sustaining system operations under extreme conditions and the back-up element in the event of equipment failure. On board the train, the result of automation is diminished importance of operating skills for the train crewman and increased emphasis on the ability to monitor automatic equipment functions. Man's primary job is not running the train but overseeing train operation and intervening when necessary. At central control facilities, automation results in more routine decisionmaking being allocated to machines, which monitor traffic flow, adjust schedules to compensate for irregularities, and alert supervisory personnel when special action outside the bounds of computer programs is required.

The conversion of train control from a manual to an automated process has produced problems on both sides of the man-machine interface. These problems arise not from any inherent inadequacy of automation technology as such; almost any level of automation is a technically viable solution. Instead, the problems stem from within the design of particular systems and from the way in which the man-machine interface is engineered. The following are specific examples of successful and unsuccessful aspects of automated equipment design drawn from the experience of transit systems with operational ATC systems.

Train Protection

ATP equipment has proven to be highly reliable; but, in a way, this reliability has also created problems. Train operators tend to take ATP for granted. ATP equipment operates so well so much of the time that the operator is inclined to neglect his responsibilities as a monitor and back-up and to forget what he must do to safeguard the train when ATP equipment is inoperative or when it has been purposely bypassed. The general experience of transit systems is that accidents tend to occur when train operators revert to visual observation and

rules of the road because the normal automatic methods of train protection are inoperative.⁷⁶

A related problem arising from ATP (and from highly automated forms of train operation) is that of vigilance. At first glance, it would appear that relieving the train operator of most routine and burdensome tasks would produce a near-ideal situation, in which he would be free to concentrate on a few surveillance and monitoring tasks and perform excellently in that role. Unfortunately, the result is almost always the contrary. Given too little to do, one tends to lose vigilance and to exhibit problems of motivation. For a person to remain vigilant, the events to be observed must occur with reasonable frequency. To keep a person motivated, the assigned tasks must be demanding enough to prevent boredom and meaningful enough to engage attention. "Make-work" tasks, or those perceived as such, are not satisfactory. The individual must feel that he has a useful and important role to play. Duties should not appear to be vestigial to machines or compensatory for their inadequacies. (TSC, 1974)

Train Operation

One of the operator's primary duties in systems with ATO is to intervene whenever either equipment performance or operational conditions fall outside prescribed limits. In some cases, however, the act of manual intervention results in a further degradation of system performance. For example, in BART where trains are normally operated automatically, the design of the system effectively precludes the operator from assuming manual control without causing a delay in service. Train speed in a manual mode of operation is limited to so percent of the speed allowable under ATO. Thus, manual takeover inevitably results in a slowing of the train and, as a consequence, following trains also. Furthermore, taking over manual control requires that the train first be brought to a full stop, thus compounding the delay. There is no technological or human impediment to operating transit vehicles manually at high speed or to changing from an automatic to a manual mode while the train is in

⁷⁶The collision of MBTA trains in August 1975 occurred in just such a circumstance. A train operating under line-of-sight rules entered a tunnel and struck a leading train waiting to be keyed by a defective trip stop. A third train, also operating under line-of-sight rules, struck the rear of the second train about 2 minutes later.

motion. The PATCO ATO system permits a man to operate the train at full speed, and the WMATA system will also, because it was recognized during the design process that such was a desirable way for man to augment the performance of an automated system.

The PATCO system also incorporates other features that promote effective cooperation between man and machine in maintaining the desired level of service. One of the train operator's responsibilities is to help complete the trip on time in case the ATO equipment should fail. Because failure of this sort is not expected to occur often, it is necessary to devise a means for the human operator to maintain his manual skills so as to be able to perform at his best when needed. In PATCO this is assured by an operating rule that requires each operator to make one trip per day in the manual running mode. The skill thus maintained also helps in other circumstances, such as when rails are slippery. ATO system performance is not as good as in manual operation in this condition. Thus, a combination of equipment design and procedures permits the system to make effective use of the human operator as a means of enhancing the performance of automated equipment. This lesson is being applied in the design of new systems such as WMATA and MTA.

The display of information to the train operator is an aspect of design that has been somewhat neglected in transit systems. Speed regulation is an important operator duty on manually operated trains, and yet there is no speedometer in the cab to tell the operator his actual speed, except in systems that have cab signals or ATO. Even with cab signals, the human factors of information display are not always given proper attention. For example, the BART operator's console originally contained only an indicator of actual speed. The command speed, with which actual speed is to be compared, was not displayed. A command speed indication was later added, but as a digital readout.⁷⁷ This form of display does not facilitate the operator's speed monitoring task since it requires making comparisons between two digital indicators, each of which may be changing rapidly. There is a considerable body of human factor research that indi-

cates digital displays are difficult to interpret for trend and rate of change, factors which are as important as speed itself in monitoring the relation of command and actual speed. An analog indicator, such as a conventional automobile speedometer, is generally a much more effective and informative display for such purposes.

Train Supervision

Train supervision is an area where, historically, there has been very little automation, except for train dispatching. All operating transit systems, except BART, supervise train movement by largely manual methods. In BART, the central computer handles tasks such as traffic regulation (schedule adjustment) and performance level modification. The train control systems under development in Washington, Atlanta, and Baltimore will incorporate similarly automated forms of train supervision,

ATS poses several design problems relating to human factors. One important concern is what to do when the computer fails. An abrupt change from automatic to manual supervision can cause major disruption of service and may even affect the safety of transit operations. Attention is being given to this problem in the design of the new systems (WMATA, MARTA, and MTA) and in planning for the addition of ATS to NYCTA. One solution is to design ATS equipment so that it does not fail abruptly and absolutely, but gracefully (i.e., in slow stages) and with sufficient coast time for human supervisors to assess the situation and decide on an appropriate course of action. New systems are also providing for intermediate levels of operation between manual and automatic. These modes allow the ATS system to operate under manual inputs or to serve as an information processing aid to human decisionmaking. The ATS system for MARTA is being implemented in two stages — semiautomated first and fully automatic later. After the second stage is implemented, the first will be retained as a back-up mode, a training device, and a means for central control personnel to retain manual skills,

Central supervisory systems, both manual and automated, also exhibit the deficiencies of display design noted earlier in connection with operator's cab equipment. Some systems do not have any form of central display board (model board) to allow supervisors to monitor the progress of trains. Personnel are required to form a mental picture of the

⁷⁷The WMATA operator's console has indicators of command and actual speed, but also in digital form—an example of learning part, but not all, of the lesson to be gained from the experience of others.

situation on the line by monitoring verbal reports from trainmen, towermen, or station dispatchers and by reading penographs or other such nonpictorial indicators. In systems that do have model boards, the supervisor's task is somewhat easier since there is a large diagrammatic representation of the track layout with lighted indicators to show train location. Sometimes, however, the model board does not indicate track occupancy block-by-block but for longer sections of track. If there is a stalled train, for example, the supervisor may know from looking at the board only that it is between one station and another but not precisely where. If a following train is ordered to close up and push the stalled train to a station or siding, the central supervisor cannot follow the progress of this operation by means of the display board. The central control facilities being designed for WMATA and MARTA will incorporate special displays that allow supervisors to "zoom in" on selected sections of track or to call up display modes of differing levels of detail to suit the task in hand.

This brief review of human factors problems associated with existing ATC installations is not intended to be exhaustive nor to single out particular systems for praise or criticism. The purpose is only to indicate the general range of problems encountered and to illustrate the need for more attention to human factors in the design of ATC systems.

Neither the recently built systems with ATC (PATCO and BART) nor those now under development have had a formal human factors program. This is not to suggest that the role of man was not considered by the planners and engineers, but there is no evidence that an explicit and systematic analysis of human factors was made a part of the design process. An exception to this general finding is MARTA, where periodic design reviews are being conducted by a team from DOT Transportation Systems Center. This team includes human factors specialists, and their examination of proposed MARTA designs has led to several suggestions for integrating man more effectively into the system.

Proper attention to the role of the individual in ATC systems can have substantial benefits for transit operations. If automation is approached not as a question of how to replace the operator in the train control system but as how to make best use of this highly valuable human resource, the safety and efficiency of ATC systems can be greatly improved. Man is particularly valuable as an element of a real-

time control system because of his versatility, flexibility of response, and ability to deal with the unexpected or the unusual. To attain these advantages, however, man must be made a partner in the system. His job must not be treated as an afterthought or as the residue of functions that equipment engineers have found technically or economically impractical to automate.

ISSUE 0-15: EFFECTS OF AUTOMATION ON EMPLOYEES AND PASSENGERS

What impacts does train control automation have on transit system employees and on passengers?

For employees, especially maintenance workers, ATC results in higher job qualifications, more extensive training, and more demanding performance requirements. For passengers, the effects are negligible except insofar as ATC influences the quality of service.

There have been no studies of the specific effects of automation in rail rapid transit systems either for employees or passengers, despite the obvious importance of these topics in the overall assessment of the social impacts of new technology. What follows, therefore, is based on anecdotal evidence and interviews with transit system managers. The applicability of these observations to transit systems as a whole is hard to determine. The experience of each operating agency is somewhat unique in that labor conditions, workforce makeup, personnel policies, and operating history vary from site to site. New transit systems, like PATCO and BART, have no previous experience with nonautomated operation against which to judge the effects of ATC. The installation of ATC equipment in older systems, such as MBTA or CTA, is both limited in scope and relatively recent. For these reasons, comparisons among systems or within systems for before-and-after effects cannot be made. The comments offered here are therefore general in nature and confined to those effects most frequently cited by system operators and managers.

Operations Employees

A primary result of the automation of train operation functions is a general shift in the skill re-

quirements for trainmen. The motor skills, coordination, and knowledge of signals and rules needed to operate a train manually are still important qualifications, but they are no longer the sole concerns. The role of ATO system monitoring and back-up places additional requirements on the operator—knowledge of how the system operates, ability to interpret failure indices, skill in diagnostic techniques, and an understanding of how aid automatic system operation without necessarily assuming full manual control. Thus, the repertory of operator performance tends to be larger in systems with ATO, and the modes of response more varied.

The selection criteria for train operators do not appear to differ substantially for systems with or without ATO, and they are about the same for bus operators in those systems that operate both modes of transit.⁷⁸ The general requirements are physical fitness and the common standards of employability (checks of police record, retail credit, and previous employment). Educational background (above a certain minimum level of schooling) and aptitude tests do not figure in the selection process, either for manual or automatic systems. Thus, ATC does not appear to alter the basic level of qualification for initial employment as a train operator.

While employment qualifications are unaffected by automation, there does seem to be a longer training program for operators in systems with ATC. The longer program results not so much from a need for more intensive training as from a need to cover a greater range of subjects. This is probably a direct consequence of the wider repertory of job skills required of operators in systems with ATO.

Since manual train operation is not a regular part of the job, systems with ATO have found it necessary to provide opportunities for practice and to test operators periodically to determine if manual skills have been retained. There is no evidence that train operator performance standards are more exacting at one level of automation than at any other, except insofar as systems with ATO call for a wider variety of job knowledge.

Train supervisory personnel appear to be very little affected by ATS. Selection criteria, training requirements, and job performance for dispatchers

⁷⁸WMATA, which now operates a bus system and is preparing to start rapid transit operations, is seeking to recruit train operators from its bus driver force.

and line supervisors are about the same for all the rapid transit systems surveyed. The BART train control room, because of the use of computers for supervisory functions, has employees versed in computer operation and maintenance—a class of employee not found in other transit systems. For these employees the skill, training, and performance requirements are, of course, unique and, because of their special expertise, somewhat higher than other types of supervisory employees.

Maintenance Employees

The major impact of ATC upon transit system employees is for maintenance workers. Traditionally, the signal maintainer was a person who had good mechanical skills and a basic understanding of the theory and operation of electromechanical devices (especially relays). This worker tended to be a generalist, in the sense that he was capable of dealing with all types of signal system failure and repair. The installation of more advanced forms of ATC and the technological shift to solid-state logic and printed circuit boards has brought about a change in the type of maintenance employee needed and in the organization of the maintenance force. New and more specialized skills are required, and the organization has become more hierarchical and segregated into specialty occupations. Transit vehicle maintenance has come to be more and more like aircraft maintenance.

The electronic nature of ATC equipment has made the diagnosis and repair of malfunctions a more complex and demanding task. Typically, this task is divided among maintenance specialists, with the first-line maintenance worker responsible only for identification of the fault and replacement of the defective module as a whole. Isolation of the fault to the component level may not be the responsibility of the first-line worker. This part of the maintenance task may be assigned to a second level of worker, who may repair or replace the failed component or who may isolate the fault further and pass a particular element along to a third level of maintenance worker specializing in that type of repair.

An additional task assigned to maintenance personnel in systems with ATC is that of configuration control. During the period following the introduction of new equipment or the opening of a new system, equipment modifications are made frequently. Because of the strong interdependency of



Track Gang



Electronic Repairmen

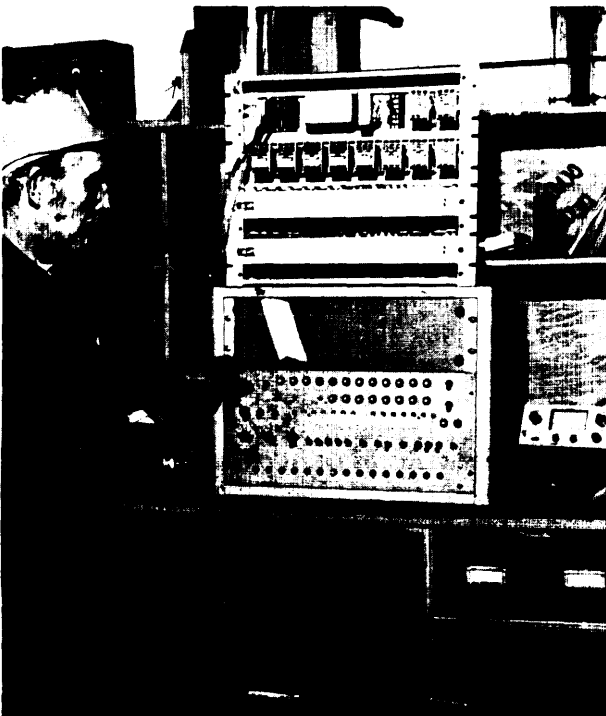

Cab Signal Maintainer

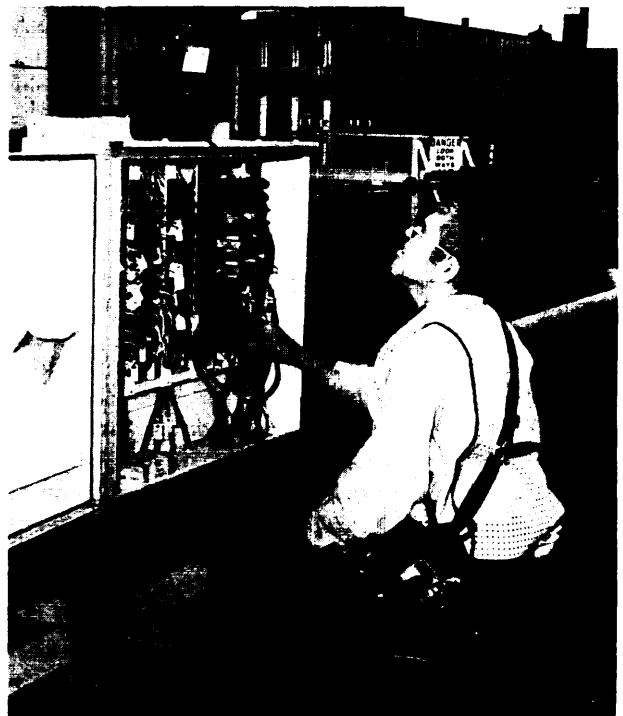

Wayside Equipment Maintainer

FIGURE 71.—Transit System Maintenance Workers

components that characterizes most new and sophisticated transit system equipment (of which ATC equipment is only an example), it is becoming more and more necessary to maintain extensive and accurate records of exactly what equipment is installed on a given car at a given time. The maintainer must spend more time with service bulletins and maintenance documents in order to keep abreast of configuration changes.

In the area of maintenance, new transit systems have some special human factors problems that are not shared by established systems. In an established transit system there is already a maintenance force in being and procedures and techniques for maintaining the equipment are familiar to all. The introduction of a new item, such as cab signals, disrupts the pattern somewhat but only for a small part of the maintenance force since the rest of the equipment is unchanged. In a new transit system, everything is new. The equipment itself may be a new design or, at least, new in its specific application. Workmen and supervisors are likely to be inexperienced in maintaining transit equipment—of all types, not just ATC. Procedures are untested and unrefined by experience. The facilities themselves are usually sized to handle normal workloads rather than the huge influx of failures and repairs that may occur during start-up. Manufacturers' representatives may be working alongside the maintenance staff making equipment modifications or assisting in debugging. The training system for preparing new maintenance workers may not yet be functioning smoothly. These conditions may result in an impairment of worker efficiency, quality control problems, and—if they persist—a lowering of worker morale.

There are also long-term effects on the maintenance force produced by ATC. The size and organization of the workforce, as noted earlier, are different. Generally more workers are needed, with special skills, and with a more elaborate division of responsibilities. The qualifications for employment as an ATC technician are usually higher and more specialized than for other types of transit maintenance workers. The period of training, both in classrooms and on the job, is often longer. The performance requirements on the job may also be more stringent. Existing transit systems that are converting to some form of ATC have had difficulty in finding qualified personnel, and efforts to recruit trainees within the existing transportation or maintenance forces have not always been successful.

Bringing in new personnel from the outside is an alternative, but the training period may be longer since they are unfamiliar with transit equipment—a disadvantage that may be partly offset by the better basic skills typically found in personnel already familiar with electronic maintenance and specifically recruited for that purpose. New transit systems, of course, have little choice but to recruit and train an entirely new maintenance force since there is no existing labor surplus of ATC technicians, either locally or nationally, to draw on.

It should be noted that ATC generally leads to an upgrading of the maintenance force. Since ATC is an addition to all the other types of transit equipment, it increases, not decreases, the number of jobs available. The pay levels for this kind of work tend to be higher than for other types of transit maintenance; and, to the extent that ATC technicians are recruited from within an existing workforce, it offers employees opportunities for advancement.

Passengers

The transit passenger typically has very little interest in the technical details of the system—ATC or otherwise. One transit system manager expressed it thus:

People use a mass transit system to get from a point of origin to a point of destination, and they want to do it quickly, reliably, comfortably and economically. The train is nothing more than a people box. The system designers' job is to create a system which will enable that people box to traverse the transit corridor rapidly and reliably, day after day after day. The passenger doesn't care—has no interest in knowing—whether the train is controlled by a master centralized computer, or localized control—whether it is powered by AC or DC motors or by little squirrels running around cages—whether it operates on standard gauge rails or extra wide rails—whether those rails are supported on timber cross ties or concrete cross ties. The passenger does care about being able to board his train every day at a preestablished time, riding in a clean and comfortable environment, arriving at his destination without being ruffled either physically or emotionally, completing the trip as quickly as is reasonably possible, and accomplishing it all at a fare which he considers to be reasonable. (Johnston, 1974)

The impact of ATC on passenger acceptance of the system would thus appear to be minimal, unless the ATC system is the specific cause of service delays-and publicly identified as such. Some transit system managers expressed the view that public confidence in a highly automated system might be lower than for a conventional system, especially during the start-up period or following some other period of operational difficulty. However, it was also believed that, once the public becomes accustomed to the system and if performance is reasonably reliable, apprehension about automation would subside. It is very difficult to gauge public opinion in this matter for there have been no studies directed to the topic of automation in transit operations. Furthermore, public comment on new systems, such as BART, tends to be in response to specific events and often does not grasp the essential technical issues.

There is a widely held view in the transit industry that a completely automated train control system without an on-board operator is not a viable proposition. Passenger safety in emergency conditions demands the presence of a transit system employee to control the situation, to evacuate the train, and to lead passengers to safety. The AIRTRANS system has experienced problems in

this regard. Passengers in unattended vehicles become apprehensive when the train stops somewhere other than at a station, even though there is no real or apparent emergency. There have been cases of passengers leaving the train and walking on the tracks, causing a shutdown of the system until they can be reboarded or led to a station. It is also believed that passengers derive a sense of security from the presence of an on-board operator, both as a source of aid in emergencies and as a protection against personal attack or crime. Unmanned vehicles are also considered to present operational problems. Without an operator to control car door closure, the passengers may adversely affect headways and capacity because of the variability in dwell time introduced by passenger-actuated doors. Systems with unmanned vehicles (and, to some extent, those with one-man trains) have also found that passengers have difficulty in obtaining information about train routes and schedules. To accommodate passengers, it has been necessary to install more extensive" signing and public announcement devices and, in the case of AIRTRANS, to hire additional station employees to provide passenger information and assistance. The human factors of system design and operation in relation to passengers is a matter that acquires increased importance as the level of train control automation increases and the level of vehicle manning declines,

Chapter 6

THE PLANNING AND DEVELOPMENT PROCESS



INTRODUCTION

The main purpose of a rail rapid transit system is to transport passengers with speed, safety, and dependability. The train control system provides the protection (ATP), operational control (ATO), supervision (ATS), and communications necessary to accomplish this purpose.

The older rapid transit systems, such as CTA, MBTA, and NYCTA, were designed to perform many train control functions manually. Until recently, the major uses of automation have been for train protection functions (ATP) and certain supervisory functions, such as dispatching. The development of new technology within the last decade or so has made it possible to automate other train control functions, and so the older rapid transit systems are now in the process of converting to higher levels of automation, especially in the areas of train operation and supervision.

Rail rapid transit systems built in recent years (PATCO and BART) and those now under construction are tending to make use of more extensive automation and more sophisticated train control than the older existing systems. Various forms of advanced ATC technology seem to figure in the plans of system designers from the very outset. Thus, it appears that the general trend in both existing and future rail rapid transit is toward increased automation. In light of this, the process by which train control systems are conceived, planned, procured, and tested assumes great significance; and it is important to investigate the way in which the ATC design evolves within the context of overall rapid transit system development.

The evolutionary cycle of ATC, like the total transit system of which it is part, has three major phases: planning, development, and testing. These phases are generally sequential but there are numerous interactions and iterative steps. For simplicity of discussion, however, the features and issues of each phase will be treated separately. At the end of this chapter is an examination of the subject of research activities that support the overall planning, development, and testing process.

The evolution of an ATC system can be lengthy, often as long as the evolution of the transit system itself. Table 31 identifies the significant dates for 16 systems—the five existing and three developmental systems considered in detail in this report and eight other systems for general reference. The CTA,

MBTA, CTS (Cleveland), and NYCTA programs involve addition of new ATC equipment or extension of an existing line. For the others, the program spans the conception and development of the entire system. The times listed include the evolution of general train control system concepts and the detailed engineering development.

The major issues associated with planning and development are examined in the order in which they generally occur in the system evolution process.

Planning (Concept Formulation and Preliminary Design)

The concept of the ATC system is usually formulated early in the overall transit system planning process. The major issues are concerned with the origin of the ATC concept, the influences which shape it, the selection of a desired level of automation, and the criteria and techniques used to evaluate the concept and translate it into a preliminary engineering design.

Development (Final Design and Procurement)

The final engineering design and procurement process may cover several years, during which the original concept may undergo substantial change. The most significant issues relate to how the engineering design specifications are written, how contractors are selected, how the development process is supervised and managed, and how emerging differences between concept and implementation are dealt with in the development process.

Testing

Testing is a continual process that begins as soon as specific items of ATC equipment are engineered and, manufactured and ends when the entire system is ready for revenue service. The issues in this area have to do with the types of tests conducted, the timing of the tests in relation to the development cycle, and the methods by which the ATC system is evaluated for serviceability and conformance to specifications.

Research and Development (R&D)

R&D is a supportive activity that runs concurrently with planning, development, and testing. The issues to be examined include the types of R&D being conducted, its application to the design of

TABLE 31.—Significant Dates in the Engineering Planning, Procurement, and Testing of ATC for Various Transit Systems

Activities ^a	Balti - more	BART	CTA (Lake St Line)	CTS (Airport Exten- sion)	Dade Co.	D/FW	MARTA	MBTA (Red Line)	NFTA	NYCTA (System Im- prove- ments)	PAAC	PATCO	RTD	SEA. TAC	Twin Cities Area MTC	WMATA
Planning ^b	1962	1951	1962	Before 1965	1964	1965	1962	Before 1966	1967	(f)	1959	1958	1969	1967	1967	1960
ATC Preliminary Design Started	1967	1953	1962		1969	1969	1966	1966	1973		Before 1963	1963	1970	1967	1969	1962
ATC Preliminary Design Completed	1973	1966	1965		(1975)		1970		1974		1970		1973		1972	1967
ATC Pro- curement Specifica- tions Issued	(1977)	1966		1966	(1978)	1971	(d)				1974	1966		1969		1971
ATC Pro- curement Contract Awarded		1967		1966		1971			(1976)		(1975)	1966		1969		1971
ATC Bebugging Started						1973		1971			(1978)	1968		1972		
ATC First Used In Passenger Service	(1981)	1972	1967	1966	(1984)	1974	(1977)	1971	(1981)		(1978)	1969		1973	(1981)	1976
Initial Plan- ing (Years)	5	2			5	4	4	1	6	(f)	4	5	1	1	2	2
ATC Evolu- tion (Years)	(14)	19	5	3+	(15)	5	(11)	5	(8)	(f)	(14+)	6		5+	(12)	14
Total Time Span (Years)	(19)	21	5	3+	(20)	9	(15)	5+	(14)	(f)	(18)	11		6	(14)	16

^aUnless otherwise noted, the dates listed are for the start of the activity. Dates enclosed in parentheses () are planned dates. All activities are for new systems except as noted.

^bATC planning is generally influenced by a number of system decisions so this date is the start of the overall system planning.

^cPreliminary design is considered to include some conceptual work as well as demonstration projects where applicable.

^dActivity is currently in progress.

^eMost transit systems are constructed in phases. The program duration listed is for a single phase or the first phase of the programs. Because early planning of multiple programs is usually comprehensive the time required for such planning will generally be longer than required for a smaller single-phase effort.

^fAt NYCTA the process of equipment replacement and updating is virtually continuous.

new systems, the use of test tracks, and major R&D needs in the area of ATC technology.

ISSUE D-1: DESIGN CONCEPTS

How do ATC design concepts originate, and by what criteria is the level of automation selected?

For new systems, ATC design concepts emerge from policy and planning decisions about the general transit system concept. Initial selection of the level of automation tends to be influenced more by social, economic, and political considerations than by engineering concerns. In already operating systems, where ATC is installed to upgrade or extend service, engineering concerns—especially evolutionary compatibility with existing equipment—are predominant. For both new and old systems, the experience of others (particularly their mistakes) has an important influence.

Some preliminary notion of the type of train control system desired is usually included in the statement of the basic transit system concept prepared by the policymaking body responsible for planning the system. For all of the transit agencies investigated in this study, the policy and planning authority is a commission or board of directors created by legislative act. The size and composition vary. Some are elected; others are appointed. The members are usually not engineers and seldom have technological backgrounds in the area of transit operation and train control, but there is always either a technical staff or an engineering consultant firm to assist the board in planning activities. Some, particularly transit systems already in operation, have staffs of considerable technical competence. For example, the CTA and NYCTA staffs do all the engineering planning for new developments and oversee procurement and testing. In general, however, the local policy and planning agency augments the technical capability of its staff by hiring consultants who conduct studies to support planning decisions and flesh out the basic design concept. In some cases, the consultant firm may also be responsible for the subsequent engineering development of the system.

The activities of the planning agency are influenced by many factors: State and Federal legislation, regulatory agency rules and decisions, UMTA

policy, economics, public opinion, local social concerns, labor relations, and political interests, to name a few. Technical considerations often play only a small part and may be overridden by these other concerns. Specific examples from among the systems investigated will help to illustrate the nature and diversity of the ways in which ATC design first takes shape.

The PATCO Lindenwold Line was planned and constructed over an n-year period. It is not clear when the basic ATC design concept was formulated; but an engineering consultant report published in 1963, about midway between the time of the initial decision to build the system and the time the line was opened for service, recommended the use of ATP and ATO. The tone of the report makes it plain that the nature of the train control system was still an open question 5 years after the planning process started. The primary justification advanced by the consultant for ATP was safety, and for ATO efficiency of operation.

In contrast, an ATC design concept for BART was established very early in the planning process and took over 20 years to evolve. Original planning studies conducted by engineering consultants to BART in 1953 to 1956 advanced the general concept of completely automatic operation at high speed and short headways. An onboard “attendant” was envisaged, not as an operator but as an aide to passengers, much like an airline stewardess. The idea of building a glamorous “space age” system employing the most advanced technology seems to have been a dominant concern in BART from the very beginning. This approach was clearly manifested in the ATC concept. The justification most often given was that advanced train control technology was necessary for the, high-speed, short-headway operation needed to attract patrons,

CTA, in planning the conversion to cab signaling, appears to have been most strongly influenced by operational and engineering factors. Cab signals were seen by CTA as an improved method of assuring train separation and preventing overspeed, i.e., as a way of enhancing safety. Compatibility with existing signal equipment and other elements of the system was also a factor (as it is in MBTA where cab signal conversion is now being implemented and in NYCTA where it is in the planning stage). Engineering and equipment concerns are also a dominant concern in the planned expansion of PATCO, where the existing ATC system dictates that the new lines have the same operational

characteristics and level of automation in order to be integrated with the present line.

Operational transit systems for airports (such as Sea-Tac and AIRTRANS) feature automatic, crewless train operation. These systems were planned and built in a rather short time span (6 years for Sea-Tac, 9 for AIRTRANS). The concept of unmanned vehicles was inherent in the nature of these systems from the beginning. It was felt by the planning agencies and their consultants that fully automatic operation offered significant savings in labor costs and was the only way to make the system economically viable.

There are sometimes general engineering decisions made during the planning process that may limit the technology that can be employed for ATC equipment. For example, a number of transit planning agencies have decided to employ only equipment already proven in use by other operating transit systems. For WMATA, the schedule set by the policy makers did not permit extensive R&D and engineering studies before selecting a train control concept. Therefore, WMATA engineers decided to specify an ATC system that could be realized with proven, existing hardware.

The formulation of the ATC system concept is also strongly influenced by events in other transit systems. The community of rail rapid transit agencies, consultants, and suppliers is a small fraternity. There is a continual exchange of information among the members and a high degree of mutual awareness of plans, problems, and operation experience. Because the supply of qualified transit consultants and engineers is limited, there also tends to be a steady interchange of personnel among transit properties, consultant firms, and equipment manufacturers. These forms of interaction assure that the experience of others will be reviewed during concept selection and preliminary design,

However, the review of others' experience is often rather narrowly focused. There is a tendency to be swayed more by specific problems and incidents than by overall statistics and the general pattern of operations. "Avoiding others' mistakes" seems to be a more dominant concern than emulating their success. For instance, the problems encountered by BART were in part responsible for the more conservative approach adopted by WMATA and Baltimore MTA. Atlanta's planners also have chosen a train control system less sophisticated

than that originally proposed by their consultants (PBTB, who were responsible for BART), partly as a reaction to the experience in San Francisco. Caution is a prudent course, but the rapid transit industry could also benefit if there were a more comprehensive body of comparative performance data to help make decisions on an analytical, rather than a reactive, basis.

The salient points that emerge from an examination of the initial planning process are that ATC design concepts originate (sometimes early, sometimes late) in policy-level decisions about the general nature of the system. The methodology employed to arrive at concept definition is often informal and influenced strongly by engineering consultant firms engaged to assist in planning the system. Except in the case of modernizing an existing system, technical considerations of train control system design seldom predominate. Route structure, service characteristics, vehicle design, right-of-way acquisition, cost, and local sociopolitical concerns tend to be given greater importance at the early stage of planning. The engineering aspects of train control are most often deferred to a latter stage of planning, when design specifications are to be written. As a result, the embryonic ATC design is usually not defined in detail until other parts of the system have taken shape. The preliminary ATC concept thus tends to develop a life and permanence without being subjected to engineering scrutiny and cost-benefit analysis to determine its appropriateness for, and compatibility with, the rest of the system,

There seems to be a crucial difference between existing and new systems. The former give greater weight to engineering concerns and specific operational needs in defining an ATC concept. New systems tend to take a broader, more informal, and less technical approach. The engineering-oriented approach offers the advantage of assuring a workable ATC system tailored, although perhaps not optimally, to specific local needs. But there is a disadvantage. The scope of the ATC concept in upgrading an existing system tends to be limited and constrained by what already exists. The bolder, "clean sheet of paper" approach employed by many new systems results in a more technologically advanced concept and greater coherence between ATC and the system as a whole, but the practical problems of development and engineering may not always be given sufficient attention,

ISSUED-2: SYSTEM DEVELOPMENT

How is the ATC system concept translated into preliminary and final functional design ?

Most system development work is done by engineering consultants, except for large established rapid transit systems where it is done by the in-house staff. The methodology varies, but there is a trend toward a more systematic and sophisticated approach using simulation, system analysis, system assurance studies, and test tracks.

The first step in the development process for ATC systems is preparation of a preliminary functional design, expressing the basic concept and its underlying policy decisions in engineering terms. The preliminary design defines performance requirements and organizes the ATC system with respect to functional relationships among system components. At this stage, the ATC system is separated into its major subsystems (ATP, ATO, ATS, and communications), and the functions required of each are specified. Further analysis may separate the system into carborne and wayside elements. The preliminary design also defines the interfaces between ATC and other parts of the transit system.

For most of the transit agencies investigated, the technical staff plays some role as engineering planner in preliminary design. However, the extent of staff involvement varies widely. In established operating agencies, such as CTA, CTS, and NYCTA, the engineering staff does almost all of the preliminary design work. In new systems, where the technical staff may be quite small, especially in the early planning phases, engineering consultants are generally and extensively used. Heavy participation by consultants is also characteristic in established systems undergoing a major program of new construction or modernization. While the proportion of staff to consultant participation varies, there appears to be wide agreement among transit system managers that staff involvement should not fall below a certain minimum level, roughly 15 to 20 percent of the design work. In this way, the authority can maintain technical involvement in the preliminary design process and exercise proper control over system evolution.

Several kinds of methodology may be employed in preliminary design. The specific methods differ widely from authority to authority, and it is difficult

to discern any common thread, beyond the general belief that technical studies are needed to gather and analyze information about the performance expected of the system. In the new systems now under development, there seems to be an increasing reliance on the so-called "systems approach"⁷⁹ and the use of techniques such as simulation, ridership analysis, function/task analysis, and cost/benefit studies. Several agencies (BART, CTA, NYCTA, Sea-Tac, and PAAC) have also conducted studies at test tracks on their properties to gather information needed for preliminary design.

The application of system analysis techniques does not appear, however, to extend very deeply into the design of the ATC system itself. There is a tendency, for instance in cost/benefit studies, to treat ATC as a whole, without examining the choices that may exist within the train control system as to degree of automation or alternative methods of achieving a given level of automation. One reason is the general lack of empirical data on the performance of ATC systems, which precludes a precise formulation of potential benefits. A second reason is the overriding nature of the safety factor which strongly influences designers to automate the train protection function, without regard for the cost/benefit relationship of ATP to other functional elements of ATO or ATS. Also, since the entire ATC package typically amounts to only 5 percent or less of the total capital cost of the transit system, there is a belief that cost/benefit analysis should be concentrated in areas where the payoff will be greater.

Thus, the process of developing a preliminary functional design of the ATC system still tends to be more art than science, but there is a trend toward use of more objective, quantitative, and systematic techniques. This is particularly evident at the points

⁷⁹The "systems approach," which derives mainly from aerospace technology, is a collective designation for techniques used to solve complex problems in a methodical, objective, and often quantitative way. The systems approach involves a logical and reiterative analysis of the system into its constituent parts, each repetition leading to a greater degree of specificity. Other characteristics of the system approach include measurability of parameters, constant recognition of subsystem interdependence, and parallel analysis of elements. The heart of the systems approach is the "System Engineering Cycle" which involves four steps: (1) convert system requirements to functional requirements, (2) convert functional requirements to specific detail requirements, (3) conduct analysis to optimize parameters, and (4) convert specific detail requirements into end products, (Grose, 1970)

of interface between ATC and other subsystems, where mutual influence and interdependence can be reduced to quantitative expression and the parameters of performance can be manipulated. Even here, however, ATC system characteristics tend to be treated as dependent variables, i.e., the driving concerns are other system characteristics, to which the ATC system design must be accommodated.

System design is a continual and reiterative process, preliminary functional design merging into final engineering design without any clear line of demarcation. The process culminates in the statement of specific equipment and performance requirements, suitable for incorporation in procurement specifications. Often, final design coincides with the preparation of procurement specifications, and it is difficult to separate the two activities. However, for the purpose of this discussion, final design is considered to include all activities needed to define the detailed technical requirements of the ATC system, up to but not including the actual writing of procurement specifications.

As in preliminary design, the final design is executed either by the technical staff of the transit agency or by engineering consultants. Here, too, the older and established agencies tend to rely more on their own personnel, and new agencies more on consultants. Usually, a single consultant is hired for final design of the complete ATC system—carborne, wayside, and central control elements. This consultant is often, but not always, the same firm that carried out the preliminary functional design of the ATC system. One reason for selecting a single consultant for the entire process is to assure continuity and coherence of the ATC design as it develops. It is also considered advisable to have a single consultant for all parts of the ATC system to ensure integration of the design of vehicle and wayside equipment and their all-important interface.

Many of the factors that shape the preliminary design of the ATC system continue to have significant influence during the final design process. Nontechnical factors still play a strong, but perhaps diminishing, role as the system moves from planning to engineering. The continuing influence of nontechnical factors is not surprising since they are usually built into the design criteria and guidelines that emerge from preliminary design and are applied to the final design. Still, as the system ap-

proaches the hardware stage, it is to be expected that purely engineering considerations should come to the fore. Generally speaking, however, the process of generating detailed engineering requirements from preliminary design criteria is basically an interpretive effort, with the experience and judgment of the designer playing the dominant part. However, there are two more formal design methods that are being used increasingly in new transit systems. They are system safety methodology and quantitative reliability, maintainability, and availability analysis.

Most of the systems now being planned are including a formal system safety study, involving definition of safety criteria, analysis of potential safety problems, and identification of ways to eliminate or minimize hazards. Some designers consider this approach to safety superior to the traditional methods of “fail-safe” design. Others disagree sharply.⁸⁰ It appears, however, that much of the controversy over the “fail-safe” and “system safety” methods is semantic; and it is premature to determine whether the results of the two approaches will differ. The important point is that designers are turning, at least in the area of safety, to more systematic and quantitative methods of analysis,

Until recently, it has not been the practice in the transit industry to specify safety requirements in quantitative form, i.e., as a numerical statement of risk or probability of occurrence. Many believe that the levels of safety which must be achieved are so high that it is difficult, if not impossible, to state meaningful quantitative standards and to devise an acceptable and practical method of verifying that they have been met. This view is not universally held, and the topic is highly controversial. However, it does appear that future ATC specifications will place strong emphasis on formal procedures by which potential safety hazards can be identified, evaluated, and reduced to “acceptable” levels. An effort is being made to put hazard analysis on a quantitative basis, but much of the work is likely to remain qualitative and judgmental. (Again, this view is not shared by all in the transit industry,) Along with the emphasis on quantitative methods, there is also a trend to define safety in a sense that is broader than just train protection and to deal with the safety aspects of the total system.

1111%111 chapter 5, page 86 for a discussion of this topic.

The second formal design method that is coming into wider use in the transit industry is quantitative reliability, maintainability, and availability (RMA) analysis. A discussion of this design technique is postponed to Issue D-4, where it is considered as part of the general question of how these aspects of system performance are written into procurement specifications.

ISSUE D—3: PROCUREMENT SPECIFICATIONS

How are ATC design requirements specified, and is there a “best” way to write such specifications?

There are two basic approaches to writing specifications—the design (equipment-specific) approach and the functional (performance) approach. Each has advantages and disadvantages. The only generalization to be made about the “best” way is that, whichever approach is used, it is of crucial importance to specify equipment performance standards and to define explicitly the means of testing.

The final design of the ATC system is documented in procurement specifications in terms of required performance for ATC functions and/or equipment components. However, the procurement specifications have a much broader scope than just a listing of required ATC system performance. Requirements for documentation, scheduling, installation, management visibility and control, and various types of testing may be specified together with numerous contractual and legal provisions. The procurement specifications include all of the detailed information required for a prospective supplier to prepare a bid.

As a general rule, the organization that does the final design of the ATC system also prepares the technical portions of the procurement specification for that system. At times, another consultant writes the procurement specifications in cooperation with the final designers. In this way some additional expert knowledge is incorporated into the specifications.

The most common method of preparing procurement specifications is by drawing on available specifications for similar equipment, from preliminary proposals submitted by equipment suppliers, or from experience gained through testing or use of

similar equipment. Often, a general incorporation of test and use experience is achieved by requiring the use of “proven technology,” which means that the same or similar equipment must have been used or tested successfully on an operating transit property in the United States.

There are two basic approaches to writing procurement specifications. Requirements can be stated in functional terms (performance specifications) or in equipment-specific terms (design specifications). The two are not mutually exclusive, and in practice something of each approach is used. Thus, implicit in even the most design-oriented specification is the expectation that the equipment should perform in a certain way,

The design type of specification indicates, to a greater or lesser degree, the equipment or system components needed to perform individual functions. In the extreme case, design specifications call for particular items, for which only a narrow range of substitutes, or none at all, are acceptable. Such specifications are often issued by transit agencies that have similar, satisfactory systems in operation and wish to assure compatibility of the new equipment with that already in place. Recent procurements of cab signaling equipment by CTA typify this approach. Somewhat less restrictive is the design specification that calls for a type of equipment with stated characteristics but leaves the supplier some room for choice. The WMATA train control system specification is an example of the modified design-oriented approach, which has some of the features of a functional specification.

Functional (or performance) specifications define what functions are to be accomplished but not the way in which they are to be accomplished. For ATC systems, the BART specification comes closest to the purely functional approach. The Diablo test track was operated for the purpose of determining the feasibility of new ATC concepts (not to select a system). At the end of the testing period a functional specification was written to accommodate any of the concepts successfully demonstrated (and many others). For example, the basic train separation system could have used radar, track circuits, or any other device that met the stated functional requirements,

Table 32 below is a rough classification of the type of specification used by seven transit systems in recent procurements. The development of the six newest systems (Baltimore, Dade County, MARTA,

NFTA, RTD, and Twin Cities) has not yet advanced to the point where ATC system specifications have been written.

TABLE 32.—Type of Specification Used in Recent ATC Procurements

SYSTEM	TYPE OF SPECIFICATION		
	Design	Functional	Combined
AIRTRANS		x	
BART		x	
CTA	x		
NYCTA	x		
PATCO			x
SEA-TAC		x	
WMATA			x

The use of a design specification permits the buyer to exercise a high degree of control over the equipment purchased. At the same time, however, it requires considerable experience and technical competence on the part of the buyer to be sure that what he specifies will perform as intended. There is always the risk that individually procured sub-systems will not prove compatible, with the buyer having no recourse but to go through a process of redesign or retrofit. If a testing procedure has been established in the specification, product evaluation and acceptance is usually easier for the buyer who has followed the design approach. To the extent that design specifications are equipment-specific, they lock the buyer into a given technology and do not allow taking advantage of innovation, economy, or other improvements that the seller might otherwise be able to effect.

One of the major advantages of a functional specification is its independence from particular means of implementation. It gives the supplier great latitude when innovation is desired or when a wide range of hardware is acceptable. This approach is most compatible with a new system being built from the ground up or with an independent part of an existing system. In effect, the functional specifications transfer some of the responsibility for system design from the procuring agency to the equipment supplier.

Functional specifications, because they are less detailed, may be somewhat easier to prepare than design specifications. On the other hand, it is some-

what harder to define the desired end product with precision. The functional specification allows the supplier to be creative, but it can also provide the opportunity for cutting corners. Litigation, as in the case of the BART train control system contract, is always a possibility if differing interpretations are taken or if the method of testing system performance is not well defined. From the buyer's standpoint, one difficulty with functional specifications is that it may not be possible to determine if the product will meet performance requirements until the complete system is assembled,

There is no universal agreement on the superiority of either type of specification. Either can be employed successfully so long as the buyer recognizes the shortcomings of the selected approach and so long as the standards for an acceptable product are clearly and fully defined. The results of the WMATA specifications, which combine a functional and a design approach, will be awaited with great interest to see if they offer a compromise solution to the problem of specifying equipment requirements and characteristics.

It is of crucial importance that both the criteria and methods of testing the equipment be made explicit in the procurement specification. From a practical standpoint, the design type of specification may offer some advantages over the functional specification in terms of the ability to define and measure reliability and maintainability—a problem that lies at the heart of the difficulties encountered by most new systems. Because of its importance, the topic of how RMA requirements are specified is treated as a separate issue immediately following.

ISSUE D--4: SPECIFICATION OF RELIABILITY, MAINTAINABILITY, AND AVAILABILITY

Are the methods of specifying reliability, maintainability, and availability (RMA) adequate to assure that ATC systems will give good service ?

This has been one of the most troublesome areas of ATC system design and development. Transit agencies are becoming increasingly concerned with RMA problems, and an effort is being made to write specifications in more precise and quantitative terms. In their present state, however, RMA specifications still fall short of what the transit industry (both buyers and manufacturers) consider satisfactory.

RMA specifications can be divided into two classes—those that state quantitative requirements and those that do not. Before issuance of the BART specifications, most transit agencies followed a nonquantitative approach to RMA specifications, and some still do. The BART specifications were a pioneering effort to introduce in the transit industry the quantitative methods used in the aerospace industry for specifying RMA. This was a major innovation at the time and, like nearly everything else associated with BART, controversial. However, all the agencies planning new systems are now incorporating some form of quantitative RMA requirements in their specifications.

Historically, reliability and maintainability have been treated only in general terms in procurement specifications by transit agencies. Some form of warranty was called for, but specific requirements as to reliability (mean time between failure, or MTBF) or ease of repair (mean time to restore, or MTTR) were not stated. Certain transit agencies continue to follow this practice for a number of reasons. In some cases, the procurement consists of additional equipment similar or identical to past purchases. Thus, the expected performance of the equipment is understood by buyer and seller to be like that already in use. Another reason has to do with the size and nature of the transit industry. There are only a few buyers and even fewer sellers, all of whom have been in business for many years. Hence, the needs of the former and the capability and reputation of the latter are well known. In such circumstances, it is considered unnecessary to draw up elaborate and detailed statements of RMA requirements. The seller is familiar with the kind of equipment now in use by a transit system, and the transit agency knows that the seller must stand behind the product in order to remain in consideration as a source of supply. A third reason for taking the nonquantitative approach, especially in small transit systems, is that the managing authority may not feel it is cost-effective (or they may not be able to get the funds) to prepare specifications that involve extensive engineering analysis, and perhaps testing.

The quantitative method of specifying RMA has found increasing favor in the transit industry for two basic reasons. First, the type of equipment now being purchased, especially for ATC systems, is much more complex and technologically sophisticated, creating a need for the document that governs the purchase of the equipment to become

increasingly detailed and precise. Second, the number of suppliers has increased and now includes firms without a long and established record in the area of train control equipment manufacture and installation. Starting with BART and continuing with WMATA, MBTA, and a number of new systems being planned, transit agencies are turning to a quantitative approach.⁸¹ Still, a decade after the BART initiative, the specification of RMA requirements remains a developing art,

There are significant differences in how quantitative RMA requirements are written, depending upon whether the procurement document is a design or a functional specification. In a functional specification, the buyer defines generic types of failures, their consequences, and required system performance. The seller is (in theory) free to configure the system in any way seen fit so long as the functional requirements are met and the system performs as expected. In a design specification, the buyer develops a specific equipment configuration, evaluates the consequences of failure of each component (equipment items not functions), and defines the component performance requirements. The seller must then meet the performance requirements on an item-by-item basis. Thus, the seller may well have no responsibility for the performance of the total system, but only for the parts as set forth in the procurement specification. In effect, the functional specification transfers much of the responsibility for detailed system design to the equipment supplier, whereas with a design specification this responsibility is retained by the purchaser.

With regard to RMA, the difference between design and functional specifications centers around the definition of failure. In design specifications the definition is reasonably clear-cut and precise. Failure means that a given component does not respond to a given input or fails to make a particular output within stated tolerances. In a functional specification, failure is defined not in terms of specific equipment performance, but more generally as the inability of the system (or subsystem) to perform certain functions. Some functional specifications (such as those prepared for BART and Sea-Tac) also identify the consequences of failure that are of concern.

⁸¹MARTA, Dade County, Denver RTD, NFTA, PAAC, and Twin Cities are all contemplating the use of quantitative RMA specifications.

A problem of interpretation can thus arise in evaluating equipment procured under a functional specification. Some failures and their consequences are defined; but others are not, even though the same piece of equipment may be involved. What then is a failure? And what particular equipment malfunctions are to be counted in determining the reliability of the purchased equipment? There is a disagreement, and litigation in progress, between BART and the ATC equipment supplier (Westinghouse Electric Corporation) as to the intent of the specification on these very points.

The WMATA train control system procurement specification, written with the BART experience in mind, attempts to deal more clearly with the definition of failure. In the WMATA specification, failure is defined as "any malfunction or fault within an equipment which prevents that equipment from performing its function in accordance with the specification." Thus, it appears that WMATA RMA requirements pertain to all equipment failures without regard to the effect on train operation. However, the specification does not clearly indicate what modes of operation are to be counted and how equipment operating time is to be reckoned in calculating MTBF. In some systems, ATC units are located at each end of the train and actually control only half the time. If a failure occurs in a unit not involved in train operation at the time of malfunction, is this to be counted as failure? And if so, how many hours has it been operating? All the time that the car has been in revenue service, or only that part of the time that the ATC unit has been used to control the train?

Without belaboring the example, it is clear that the transit industry still has not reached a full and universally accepted understanding of how to specify and test equipment reliability. A recent statement by a representative of an equipment manufacturer (King, 1975) highlights the continuing problem.

Success and failure of transit equipment and systems must be defined in relation to their mission. Indeed, the term "mission" itself probably requires redefinition. Many industry specifications in recent years have not agreed on such points as whether a transit vehicle completes its mission at the end of one trip or the end of a full day, or when that day ends, or whether the vehicle must be available during all peak service periods. If the function of transit equipment is

carrying passengers, has a mission failed if an equipment outage occurs during nonrevenue service? These are some of the fundamental questions which must be answered to define traditional reliability in a manner acceptable to transit industry application.

One of the significant problems affecting the ability of the transit industry to draw up meaningful RMA specifications is the lack of a data base describing the performance now being achieved in the industry. Individual manufacturers have some information, as do individual transit systems, but there is no uniform method of reporting and no available industry-wide data base.

This need has been recognized by transit agencies and equipment manufacturers; and, through their industry organization (the American Public Transit Association), an effort is underway to deal with the problem. APTA task group, known as RAM (for Reliability, Availability, and Maintainability), has been assigned the responsibility of developing recommendations for a standardized data collection and reporting procedure. The problem of making these data generally available, free from local transit system bias and manufacturers' proprietary concern, is still unsolved,

ISSUE D-5: ' EQUIPMENT SUPPLIERS

What firms supply ATC equipment? Is there transfer of ATC technology between automated small vehicles and rail rapid transit systems?

Historically, two U.S. firms—GRS and US&S--have supplied most of the ATC equipment to the rapid transit industry. In recent years, several new firms, supplying either special product lines or control equipment for small vehicle systems, have entered the market. The major transfer of ATC technology is from rail rapid transit to small vehicle systems, but not the reverse.

The suppliers of ATC equipment to the rail rapid transit industry fall into two distinct groups: those that provide a broad line of services and equipment and those that have limited lines or specialty products. There are many firms in the latter category, but the former includes four companies, General Railway Signal Company (GRS) and Union Switch and Signal Division of the Westinghouse Air Brake

Company (US&S)⁸² are old, established firms that have a long history in the signals and communication business and have dominated the market. Recently, two new suppliers have entered the competition. Westinghouse Electric Corporation (WELCO) supplied the ATC system for BART, where they were low bidder against GRS and US&S. Transcontrol is furnishing the ATC system for the San Francisco MUNI light rail system and for the Toronto Transit Commission in Canada,

There are many more suppliers of ATC equipment for small, automated-vehicle, fixed-guideway systems. In addition to GRS, US&S, WELCO, and TransControl, the list includes Philco-Ford, TTI (now TTD) and Varo Monocab.

The number of firms supplying small-vehicle ATC systems, and the organizational relationships among them, change from year to year. Some drop out of the market, new ones enter, and others form joint ventures or acquire each other. It is a market where there are many more companies offering systems than have actually received contracts for installations. Further, the resulting contracts are usually rather small. The complete "Satellite Transit System" installation (guideway, vehicles, and controls) at the Seattle-Tacoma airport was about \$7 million, while the AIRTRANS system at the Dallas-Fort Worth airport was about \$31 million. The ATC portions of these systems were about 7 to 12 percent of the total contract prices.⁸³

To date, transfer of technology between conventional rapid transit systems and the new small vehicle systems has been in one direction—from the conventional to the new systems. Reverse transfer, and entry of small vehicle system developers into the conventional rail rapid transit market, has not occurred, perhaps due to the much larger size of the contracts and capital commitments required to compete in the conventional rail rapid transit market, or perhaps due to the failure of AGT suppliers to develop workable systems for rail rapid transit application.

While some foreign-made ATC equipment is utilized in the United States, the market is not really

⁸²Union Switch and Signal is also referred to by the acronym of its parent firm, WABCO.

⁸³In relative terms, this proportion is somewhat greater than the 3 to 5 percent of total contract price that is typical for rail rapid transit systems. The absolute dollar amounts, however, are quite small.

receptive to foreign incursions. There are several reasons. Some procurement specifications exclude foreign suppliers by requiring prior transit service in the United States or by including restrictions on foreign-made components. Also, U.S. transit agencies tend to doubt that foreign suppliers would be able to provide continuous long-term service. Finally, there are some major differences between U.S. and foreign ATC technology and engineering techniques.

ISSUE D-6: CONTRACTOR SELECTION

How are contractors for ATC design and engineering selected?

The lowest technically qualified bidder is usually selected. Competitive bidding and award to the low bidder is required by law in many States.

Usually, two or more suppliers will compete for the opportunity to design, build, and install ATC system hardware and software in response to the technical specifications describing required system characteristics. Ultimately, responsibility for selection of the supplier rests with the directors of the transit authority. Most frequently, the directors rely on their technical staff for evaluation of the proposals and for monitoring the work of the selected contractor. This procedure was followed at CTA, CTS, MBTA, NYCTA, and PATCO. However, at BART, the general engineering consultant (Parsons, Brinckerhoff-Tudor-Bechtel) was delegated authority for some of the contractor selection and management. Interviews with personnel at new systems in the planning or early construction phases (MARTA, RTD, WMATA, Baltimore, NFTA, and the Twin Cities) indicate that these agencies will also utilize consultants to assist in contractor selection and management.

The increasing involvement of consultants in contractor selection and management for new rail rapid and small vehicle systems reflects the increasing complexity of new rail rapid and small vehicle systems. The design and development of such systems is often beyond the capability of the limited staff maintained by most transit agencies. It should be noted, however, that consultants may have somewhat different motivation and may use somewhat different evaluation criteria than the transit authority,

Contractor selection is relatively simple when “off-the-shelf” equipment is to be used and the competition reduces to a matter of price among prospective suppliers, all of proven capability. Often, however, the available equipment does not satisfy all of the specifications and requirements. Contractor selection then involves identifying qualified suppliers, publishing an invitation for bid, evaluating the bids received from the prospective suppliers, and awarding a contract. Table 33 summarizes the contractor selection approaches used by transit authorities in several recent procurements.

Several of the transit authorities require that a prospective ATC system supplier be a manufacturer of equipment proven in use on operating transit systems in the United States. If the ATC system at BART is considered to be proven, this restricts the list of qualified ATC equipment suppliers to just three companies: GRS, US&S, and WELCO. However, technical personnel at some authorities do not accept the BART ATC system as proven. Thus, only GRS and US&S are presently considered qualified by these authorities. The list could be enlarged by including Transcontrol if Canadian installations were accepted.

The opportunity for a new company to become qualified as a supplier of ATC equipment is offered by several authorities, who will permit the company to install and demonstrate ATC equipment at a test track location on the authority’s property. If testing proves that the equipment has desirable performance features together with acceptable safety, quality, reliability, and maintainability, the authority’s technical staff may approve this company’s qualifications to bid for the next ATC equipment procurement. The prospective supplier must bear the expense of the demonstration equipment, installation, maintenance, and testing in this prequalification program.

Prior to 1969, the Dallas/Fort Worth Airport Board conducted an investigation of possible suppliers of an automated system. As a result of this investigation a Varo/LTV/GRS team and Dashaveyor were selected as the two (and only) qualified candidates. These two submitted preliminary engineering reports in October 1969. In 1970, Varo/LTV/GRS and Dashaveyor received technical study grants for demonstration of their systems at the plant. Initial bidding for AIRTRANS took place in March 1971, with Varo/LTV/GRS and Dashaveyor being the

TABLE 33.—Contractor Selection Approaches

Transit System	Bidder Qualification	Evaluation Process	Contract Award
BART	(d)	(b, c)	WELCO
CTA		(b)	GRS, US&S
CTS	(d)	(b)	GRS
D/FW	(e)	(b, c)	GRS
MARTA	(d)	(b, c)	
MBTA	(d)	(b)	GRS, US&S
NYCTS	(a, d)	(b)	GRS, US&S[®]
PATCO	(d)	(b, c)	us&s
SEA-TAC		(b, c)	WELCO
WMATA	(g)	(b)	GRS

- (a) Demonstration at test track.
- (b) Low bid.
- (c) Proposed performance.
- (d) Manufacturer of proven equipment.
- (e) Demonstration at plant was an original requirement.
- At a second bidding there was no such prequalification.
- (f) R-44 and R-46 procurements.
- (g) Preliminary proposals.

only bidders allowed. One bid was rejected as too high, and the other was rejected as not responsive to the specifications. In May 1971, a second bidding took place with four bidders: Bendix/Dashaveyor, VSD-LTV, WABCO Monorail Division, and WELCO. VSD-LTV was selected as the supplier. The subcontract for the train control system was awarded to GRS by VSD-LTV.

The "invitation to bid" requests a cost quotation for supplying the ATC system and services defined in the procurement specifications. The solicitation may also require submission of a technical proposal that describes how the bidder intends to satisfy the requirements of the procurement specifications. In addition to the technical requirements, provisions for documentation, program planning, management visibility and control, quality control, acceptance and systems assurance testing, and the many other factors specified as important to the procurement must be taken into account by the prospective supplier in preparing his bid. Experience shows that it is very difficult to add or increase a requirement once an "invitation for bid" has been published and the prospective suppliers' responses have been received.

As a general rule, competitive bidding is employed by the transit authorities; and, in most cases, competitive bidding is required by State law or local ordinance. Usually, however, the authorities reserve the right to reject all bids and have a new solicitation. This study has disclosed no instances where a sole-source solicitation had been employed.

The established transit agencies select an ATC equipment contractor from previously qualified suppliers on the basis of the lowest price. Other agencies employ a single-step process where technical capability and cost are weighed together. WMATA was unique in that they used a two-step process in which the responsiveness of prospective contractors' proposals to the procurement specifications in a prebid solicitation was used to make a selection of qualified bidders. Subsequent selection of the winning contractor from the two qualified bidders was based solely on cost.

To date, cost estimates and award to the low bidder have been based solely upon the capital costs of system development and construction. Life-cycle costing, which would require cost competition based upon both the capital and operating costs, is an alternative costing method that has not been

used but may find increasing favor as energy and economic conditions cause a shift in values.

ISSUE D-7: CONTRACT MANAGEMENT

How is the performance of the contractor(s) monitored and how is system development controlled?

There are two basic methods. The transit authority may monitor development using in-house engineering staff. Alternately, a general contractor or consultants may monitor progress. Use of in-house staff, when such capability is available, is more likely to ensure that criteria important to the operating agency are applied during evaluations of progress. On the other hand, the necessary expertise may not be available in house, especially in new properties.

Once a contract has been awarded, data on program status and control over program direction available to the transit authority management are limited to that specified by the contract. Therefore, it is important that the contract provide the means for monitoring the contractor's progress and for exerting some directive control over contractor activities.

Management control is achieved in many ways ranging from a resident engineer at the contractor's plant to formal design status reviews, RMA predictions, progress reports, and other such techniques. Traditionally, management control of an ATC system contract has been achieved by assigning signal engineers from the authority's staff the task of monitoring the work of the ATC contractor. These engineers are expected to know the status of the contractor's program at all times throughout the contract, and, in particular, to be aware of any problems and the work being done to solve them. They also direct contractor progress by exercising approval of designs proposed by the contractor,

Maintaining management control has become increasingly difficult as ATC systems have grown more complex. BART, PAAC, and WMATA ATC system procurement specifications included provisions for system assurance programs, periodic design reviews, and other modern management techniques. Several transit authorities expect to hire separate consultants to plan, specify, and monitor the system assurance programs for their ATC pro-

curements. These consultants will report directly to the transit authority technical staff.

One important method for achieving management control is independent review of the ATC manufacturer's design. This review may be conducted by the transit authority engineering staff or by engineering consultants. The manufacturer is required to correct all the deficiencies identified. Besides providing an independent evaluation of the manufacturer's design, this procedure also educates the reviewer on the details of the design. This particularly is important in new systems where the staff may not have lengthy transit experience. A variation of this approach is being used at MARTA. Periodic reviews of the MARTA train control system design are being held under the auspices of UMTA, with the DOT Transportation Systems Center serving as a technical consultant.

Established transit properties such as CTA and NYCTA have traditionally required the manufacturer to continue to correct equipment deficiencies until the equipment performance is acceptable to the chief engineer. Management control by these authorities succeeds, in part, because of the limited market for ATC equipment. If an ATC equipment manufacturer wishes to remain in business, he must necessarily satisfy his customers, and these two are the largest in the country. The major change in methods of management control for the new ATC system procurements is the introduction of requirements for detailed program planning by the contractor. The increased management involvement permits control action to be taken immediately when a deviation from the program plan is noted. This makes it possible for management to avoid potential problems rather than waiting until they occur and require drastic action to correct.

Upon completion of the manufacturing process, the ATC equipment is delivered to the transit authority, installed, and tested. Test procedures are described in the next issue.

ISSUE D-8: TESTING

How are ATC systems tested? What kinds of tests **are** conducted, for what purposes, and when in the development cycle?

There are three categories of ATC system testing, each beginning at a different stage in the system life cycle and satisfying different needs.

Engineering testing occurs early in the development cycle and provides data for detailed system design and modification. Assurance testing is performed to evaluate how well the equipment meets procurement specifications. Acceptance testing is performed when the whole ATC system has been installed and debugged and may be performed on significant subsystems before their 'integration into the total system. Acceptance testing is the final demonstration that the system meets specification. There is room for improvement in several areas—test planning, documentation, and dissemination of results.

Testing serves a number of important functions in the development process. It provides the data necessary to support ATC design. It serves to identify actual or potential problems during manufacture and installation. It is the means to verify that the resulting system meets specified requirements.

There are three basic types of testing: (1) engineering testing, (2) assurance testing, and (3) acceptance testing. Each is initiated at different times in the system life cycle, and each satisfies different needs, but they are not mutually exclusive. They frequently overlap in time, and data obtained in one type of testing may be useful for the purposes of another. Although all three types of tests are initiated prior to opening of the system, they may extend well into the period of revenue service.

The results of testing are of primary interest to the transit agency installing or modifying an ATC system and to its system contractors. The test results may also be of value to other authorities who are planning a similar system. Careful planning of tests, description of test procedures, and documentation of results is essential to maximize the value of testing.

Of particular interest for this report is the adequacy of the testing process in terms of planning, procedures, and documentation of results. Also of interest is responsibility for testing and evaluation of test results. Finally, the degree to which test results for one system are utilized at others planning similar systems deserves exploration.

Engineering Testing

Engineering testing begins early in system development and includes tests of components and

subsystems to verify that they perform as expected. There are also tests undertaken to diagnose the cause of a problem and assist in its solution. This second category of tests is called “debugging.”

Engineering tests are generally performed by the ATC system contractor to support equipment design and manufacture. Results are not always documented and are generally not submitted formally to the transit authority. A representative of the authority may be in residence at the supplier’s plant and may monitor engineering test results. NYCTA, for example, follows this procedure.

Because engineering testing occurs early in system development and there is higher order testing later on, it is probably not necessary to have more formal documentation and wider dissemination of engineering test results than is presently the custom. Furthermore, manufacturers frequently consider the results of these tests to be proprietary.

Assurance Testing

Assurance testing includes inspection and quality control during production and tests to ensure that the equipment meets procurement specifications.

In general, the procurement specifications include provisions for the quality control program. Unfortunately, quality control programs are not always adequate. For example, the BART ATC system procurement specifications provided for such a program, but strong and effective quality control was really not achieved. An effective quality control test program must include not only a good inspection and test program but management procedures to follow up and correct deficiencies.

Besides quality control, tests are conducted to demonstrate that equipment meets specifications for performance, safety, reliability, maintainability, and availability. Such tests are performed on individual components at the factory or as they are installed, then on subsystems, and eventually on the whole ATC system. Failure of the equipment to perform according to specifications leads to diagnostic testing to isolate faults and correct them—another type of debugging. Ideally, these tests would be completed and all deficiencies corrected before revenue operation. However, the length of time required for some kinds of assurance tests (notably reliability) and pressures to begin passenger service often dictate that operations start

before the tests are completed. Some transit authorities recognize this necessity by indicating in the procurement specifications those assurance tests that must be completed before revenue service and those that will be accomplished during revenue operation.

It is important to note that statistically significant tests to demonstrate ATP safety probably cannot be conducted. The required levels of safety are so high that a valid quantitative test for safety would take years or even decades to complete, even if accelerated testing methods were employed. As a result, assurance of ATC safety is accomplished by a combination of analysis and testing. The analytical work is done to identify possible design or engineering defects that could produce an unsafe condition. Testing then concentrates on these areas. While it may not be able to produce statistically significant results, test data of this sort can lend credibility to engineering judgments made about safety.

Acceptance Testing

Acceptance testing is the final set of tests on the completed ATC system to demonstrate that the system meets all procurement specifications. Acceptance testing is specified in detail as part of the ATC system contract and usually consists of an integrated series of tests which take place over months or years. Acceptance testing tends to concentrate first on safety features, then on performance, and finally reliability and maintainability. Formal tests of the personnel subsystem and man-machine integration are seldom, if ever, conducted. Problems in this area are detected and corrected as they arise in the course of other testing or operations. The ATC system is accepted by the procuring agency when it has been demonstrated that specification requirements and contractual acceptance provisions in the contract have been met.

The planning, conduct, and communication of test results are basic to all three categories of testing. The adequacy of documentation of plans, test procedures, and results was reviewed during this study in order to evaluate the testing process. The general conclusion is that documentation of test plans has been less than adequate,

From interviews with representatives of transit systems now being planned, and from examination of procurement specifications, it is apparent that there will be increased emphasis on formal documentation of test plans in the future. For example,

the PAAC ATC system procurement specifications require the contractor to prepare and submit various test plans appropriate to the different categories of testing. As another example, MTA Rapid Transit Development Division (Baltimore) expects to hire a reliability, maintainability, and system safety consultant who will be required to plan a comprehensive and integrated program for the entire transit system, including the various system assurance tests pertinent to RMA and safety. This consultant will work with both the general engineering consultant and the ATC system design subcontractor.

Confidence in test results is determined to a large degree by the detail to which testing procedures are documented. Careful attention to details such as accuracy, precision of measurement, and control of the test environment is important. In some cases, it is difficult to assess the quality of testing that has been conducted in existing transit systems because documentation is lacking or inadequate.

For testing to be of maximum value, the results must be communicated to interested parties. Within a single organization, this may be accomplished informally by oral report or internal memoranda. However, in an integrated test program, more formal reporting procedures are necessary to assure that the test results are properly disseminated. As in test planning and performance, there is room for improvement in the dissemination of results, particularly outside of the transit agency.

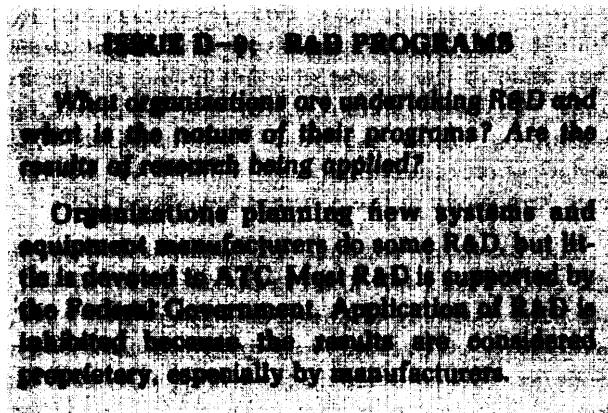

R&D may be defined as discovery of new knowledge and its development for use in practical application. R&D must be distinguished from applications engineering which refers to the solution of specific technical problems. With this distinction

in mind, the following summarizes the organizations which might be expected to perform R&D in ATC and their involvement in such activity.

R&D Programs

Operating transit agencies perform very little ATC R&D. Fiscal realities of the operating environment do not support such activity. Operating agencies do conduct ATC applications engineering.

Agencies planning new rail rapid systems and their subcontractors perform R&D in the course of system development--chiefly design and development of new hardware, test track demonstrations of new concepts, and basic analytical work. Funds may be provided for such purposes by the Federal Government as part of technical study programs and capital grants. Transit agencies sometimes use their own funds to support such work.

The American Public Transit Association (APTA) is the principal rail rapid transit industry association. Some of its committees are active in areas related to ATC, principally safety and reliability. Such work is paper-and-pencil studies and is supported by member organizations. The Transit Development Corporation is an industry-organized R & D corporation. No programs specifically related to ATC have been undertaken,

Some R&D in ATC reliability and small vehicle systems is done by manufacturers. This work is supported primarily by private investment. There has been some private investment in test track demonstration programs. (See Issue D-10, p. 151.) Most industry work in ATC for rail rapid transit is applications engineering.

Educational research organizations, such as the University of Minnesota, Northwestern University, Aerospace Corporation, and Applied Physics Laboratory, have funded contributions to the literature for small-vehicle, fixed-guideway systems. They have not made substantial private contributions to rail rapid transit R&D for ATC.

The Federal Government is the principal source of R&D funds. Major Federal support to assist testing and demonstration of ATC equipment for conventional rail rapid systems was given in the mid-1960's in conjunction with the BART and Transit Expressway test tracks. (See Issue D-10, p. 151.)

Recent Federal programs have generally been associated with support of major vehicle or system

concept development rather than ATC as such. These programs include the State-of-the-Art Car (SOAC), the current Advanced Concept Train (ACT I), the TRANSCO '72 demonstrations, the Standard Light Rail Vehicle, PRT activities at Morgantown, West Virginia, and the now-canceled Dual-Mode Program,

In small vehicle technology, a new project directed toward the development of a high performance PRT (HPPRT) system has major ATC elements. Also, the Applied Physics Laboratory (APL) of Johns Hopkins University has been providing more or less continuous support to UMTA in PRT technology. Most of the APL work has focused on analytical studies of operational and reliability problems associated with PRT systems. APL has also provided general technical support to UMTA, notably as a technical monitor (with MITRE) of the TRANSCO '72 PRT demonstrations.

Recent and current work in system assurance has been closely allied with ATC technology and the question of manned versus unmanned vehicles. An UMTA-funded ongoing program in these areas is being conducted by the Transportation Systems Center (TSC). One product of this work was a report entitled "Safety and Automatic Train Control for Rail Rapid Transit Systems," published in July 1974. It is expected that the results of the TSC investigation of system assurance and the question of manned/unmanned systems will be available in 1976.

Except for the APL work, there has been little support for the development of analytical tools needed to evaluate ATC (and other) problems associated with advanced technology systems. This situation now appears to be changing. A part of the now-canceled Dual-Mode project was to have involved development of the analytical tools necessary to evaluate such general concerns as operational strategies and reliability. Such a requirement is included in the later phases of the recently initiated HPPRT program.

There are indications that a more programmatic approach to ATC technology for small vehicles will be initiated. UMTA is currently developing an Automated Guideway Technology (AGT) program which will deal with many system and subsystem problems on a generic rather than project-specific basis. If there are any significant contributions to rail rapid transit system of these programs, they are likely to fall in the area of the development of

methodology and analytical tools. Equipment requirements for AGT and rail rapid transit are so different that contributions to rail rapid transit hardware technology are unlikely. However, better analytical tools would be an important contribution.

Application of R&D

The application of the results of R&D varies according to the sponsoring organization, Privately supported R&D, such as is done by manufacturers, is generally proprietary and not fully available to the industry. Unfortunately, this is where most of the expertise resides,

The results of federally supported research and that conducted by educational institutions generally finds its way into the literature, Much of this work is more theoretical than practical in outlook. Further, such work is often concerned with automated small-vehicle technology rather than more conventional rapid transit. The increasing involvement of the Federal Government in rail rapid transit may change the situation.

Transit agencies planning new systems or modifying old ones generally exchange information, on a personal basis, with their counterparts at other transit agencies, This helps to compensate for the lack of research literature and the withholding of proprietary data held by manufacturers.

ISSUE D-10: TEST TRACKS

What role do test tracks play in ATC R&D? Who operates and funds test tracks?

Test tracks are not built solely for ATC studies but to serve several objectives, and their value should be judged accordingly. For development of ATC, test tracks are used for R&D, demonstration of conceptual feasibility, and hardware test and evaluation. By permitting scientific and engineering work in the absence of constraints imposed by revenue service, test tracks are vital to advances in transit technology. Some test tracks have short life spans. Others are more or less permanent facilities. They are operated and funded by the transit agencies, manufacturers, and the Federal Government.

As used here, a test track is a facility built expressly for the purpose of engineering and scientific

studies, and not revenue trackage that may be used for test purposes. Thus, the Morgantown project is not a test track. The TRANSPO '72 exhibition, while perhaps better classed as a demonstration, is included because of the post-TRANSPO test program. Test track programs discussed below are categorized by the three types of organizations which operate them: transit agencies, manufacturers, and the Federal Government.

Transit Agencies

BART Diablo Test Track.—The purpose of this track was to demonstrate the conceptual feasibility of alternative subsystems for BART—not, as commonly thought, to select hardware to be procured. The results of the program were used as a basis for writing functional specifications for BART equipment.

The 4 1/2-mile test track was located between Concord and Walnut Creek, California. It was operated in the mid- to late- 1960's, at a total program cost of about \$12 million. The Federal Government supplied about two-thirds of the funds, and BART the remainder. Most suppliers participating in the program are believed to have invested substantial funds of their own.

ATC was 1 of 11 different system elements studied at the track. Because the purpose was concept demonstration using prototype hardware, reliability and maintainability studies were not part of the ATC test program. Four ATC systems were demonstrated, Suppliers were General Electric, General Railway Signal, Westinghouse Air Brake, and Westinghouse Electric.⁸⁴The results of the formal tests were that all four systems met the general requirements for BART ATC, with no one system significantly better.

After final ATC specifications were prepared by BART, the winning contractor, Westinghouse Electric, was selected on the basis of low bid. Because the WELCO system was developed in response to new specifications and designed to be price-competitive, it is not surprising that it differed from any demonstrated. This system was not subsequently tested on the Diablo track before final systemwide installation. Whether such testing would have avoided some of the later ATC problems encountered in BART depends upon the

⁸⁴The Philco Corporation also tested portions of an ATC system later, after the completion of the formal test program.

type of tests which might have been performed and the criticality of the analysis of results, rather than the particular track used.

PAAC Transit Expressway Program Transit Expressway.—This program, conducted by the Port Authority of Allegheny County, ran from June 1963 to November 1971 at South Park, 11 miles from downtown Pittsburgh. The objective was to design and develop a new technology—namely a fully automated system of medium-size, light weight, self-propelled vehicles which could be operated singly or in trains of 10 or more vehicles. The work was done in two phases at a cost of \$7.4 million. Two-thirds of the funds were provided by the Federal Government; and the remainder was provided by Allegheny County, the State of Pennsylvania, and Westinghouse Electric.

As the first fully automated transit system, significant development work was done on ATC. The ATC system underwent major changes between the first and second phases of the program. The final system is comparable to BART, with the exception of the train detection equipment which was specifically designed to detect the rubber-tired vehicles planned for the system.

The importance and value of this program lies in the many innovations demonstrated there and later incorporated into systems now operational elsewhere. The ATC technology has been used by Westinghouse Electric for the Seattle-Tacoma and Tampa airport systems, for BART, and for the Sao Paulo METRO in Brazil. PAAC used the project to develop procurement specifications for TERL, a program recently defeated by the voters.

Manufacturers' Test Tracks

Manufacturers' test tracks have been built primarily for work on automated small-vehicle systems. These tracks are used either to develop new systems, to check equipment prior to delivery, or both. Federal funds may be used, as was the case of the Dashaveyor and Varo test tracks which were used for feasibility studies conducted by these companies for AIRTRANS at the Dallas-Fort Worth airport. Some company test tracks that have been used for ATC development or checkout are:

- Dashaveyor, Pomona, Calif.
- Varo Monocab, Garland, Tex.
- WABCO Monorail Division, Cape May, N.J.

- . TTD, Denver, Colo.
- Bendix, Ann Arbor, Mich.
- Alden, Milford, Mass.

Federal Government

TRANSPO '72.—Four automated small-vehicle systems were demonstrated at TRANSPO '72 and later evaluated in a test program conducted between August and November 1972. Federal funds amounting to about \$7 million were provided for the demonstration and test program. There was also substantial private investment. The exact amount is unknown, but it is thought to be of the same order as the Federal contribution. The systems demonstrated and their manufacturers were:

- . Dashaveyor System—Bendix Corporation
- . ACT System—Ford Motor Company
- Monocab System—Rohr Industries
- . TTI System-Otis

The systems were developed under tight time constraints with limited funds. This led to some compromises in the ATC system design. The post-TRANSPO test program showed that some of the ATC equipment had undesirable control characteristics, including long delay times and speed oscillation. It was concluded that the basic cause of these problems was the prototype nature of the equipment.

Apart from its value as a public demonstration of new technology, the major benefit of the TRANSPO '72 program was the increased capability in small-vehicle technology gained by the four participating manufacturers. Because of basic differences in philosophy and operating characteristics between automated small-vehicle systems and rail rapid transit and because of the less stringent demands placed on a system in an exhibition (in comparison to a revenue operation), the TRANSPO '72 program had limited value in improving ATC systems for general transit industry application.

Pueblo Colorado Test Facility.—DOT's High Speed Ground Transportation Center at Pueblo, Colo., became operational in 1973. Managed by the FRA, the Center can test several types of ground transportation systems. Both advanced systems and rail technology programs are conducted. The former programs include the Tracked Levitated

Research Vehicle (TLRV), the Tracked Air Cushion Research Vehicle (TACRV), and the Linear Induction Motor Research Vehicle (LIMRV). For rail technology programs, the Center includes 20 miles of conventional railroad trackage, used for studying train dynamics under a variety of track and grade configurations, a 9.1-mile oval rail transit track with a third rail for testing electrically powered rolling stock, and a Rail Dynamics Laboratory for simulator testing of full-scale railroad and rail transit vehicles. As a part of the now-canceled Dual-Mode Program, it was planned to build two guideway loops at the site, each 2 miles in circumference.

Probably the most significant rail transit activity at Pueblo was the testing of the State-of-the-Art Car (SOAC) in 1973. There was little ATC related work associated with this R&D activity, and the ATC provisions at Pueblo are all but nonexistent. There are several reasons for this. DOT has been using the facility for other purposes. Limited facilities are available. (For example, there are no provisions for inserting signals into the rails.) The site is very remote from both operating properties and equipment suppliers. Most transit agencies feel it is essential to conduct final ATC development work in the actual operating environment (atmospheric, electrical, etc.) where the equipment will be run. Unless there are specific federally funded programs requiring that the work be conducted at Pueblo, it seems unlikely that significant amounts of ATC research for rail rapid transit will be conducted there.

ISSUE D-11: RESEARCH NEEDS

What are the major needs for research and development in ATC technology?

R&D to obtain new and more advanced ATC technology for rail rapid transit is not required at present. Rather, the need is to seek refinements in existing technology which will result in improved reliability, maintainability, and system performance at reduced cost.

The MITRE Corporation (1971) conducted a survey of rail rapid transit agencies and equipment manufacturers to identify problems that should be addressed in a federally funded research program. Of the 11 top priority areas indicated by this survey, none had any direct relationship to ATC. The results must be accepted with some caution because

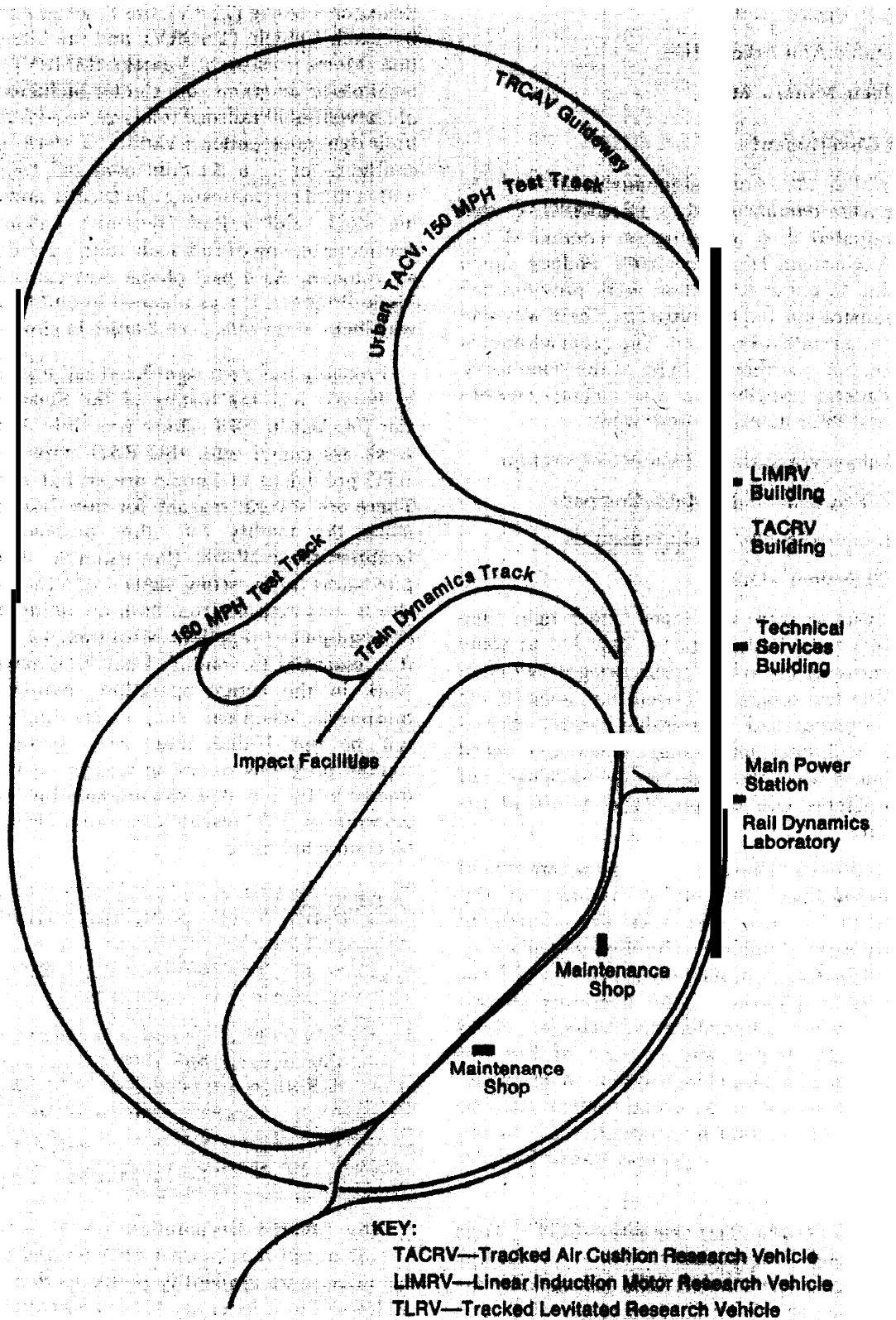

FIGURE 72 DOT Test Track, Pueblo, Colorado

none of the industrial firms surveyed were ATC equipment manufacturers and because the intent of the study was to identify problems for investigation at the DOT Pueblo test site. (As indicated earlier in Issue D-10, p. 151, the Pueblo test facility is not suited for investigation of ATC problems.) Still, the survey does suggest that ATC is not viewed as a major R&D problem by a significant part of the transit industry.

During visits to transit agencies made by Battelle Columbus Laboratories as technical consultants in this assessment, comments and suggestions were solicited on R&D needs in rail rapid transit technology, particularly those associated with ATC. Here again, the results indicate that ATC is clearly not a major concern.

Operating transit agencies felt that the major R&D needs were:

- Improvement of chopper control, multiplexing of train lines,⁸⁵ and a.c. traction motors;
- Documentation of slip-slide tests for use in official and expert testimony in damage and injury suits;
- Clarification of the trade-off values associated with such technical matters as analog vs. digital signals, control signal frequencies and modulation rates, types of station stops, choppers vs. cam controllers, and the use of p-wire;
- Review of the availability and allocation of radio frequencies for both voice and data transmission by transit systems;
- Development of a data base and clearinghouse for reliability and maintainability information for the benefit of transit systems and manufacturers.

Transit systems in the planning and construction stages had a differing set of priorities:

- Investigation of electromagnetic interference problems;
- Improvement in the reliability of ATC systems and related equipment;
- Study of techniques for, and the value of, regenerative braking;
- Establishment of a data bank on the safety,

⁸⁵The underlined items are those directly or indirectly related to ATC.

reliability, and maintainability experience of operating transit systems;

- Maintenance training programs to ensure that new and sophisticated transit equipment (including but not limited to ATC) can be properly cared for;
- Studies of collisions and crash resistance, particularly for small-vehicle systems.

Since one of the main purposes of this technology assessment was to weigh the need for R&D in the area of automatic train control, this topic was given special attention. In addition to review of the literature and collection of opinion within the transit industry through the interviews cited above, the matter of research needs and priorities was made the subject of a separate investigation by the OTA Transportation Program staff and the OTA Urban Mass Transit Advisory Panel. This investigation drew especially on the experience of individual panel members and of various transit system managers, equipment manufacturers, technical consultants, and DOT officials. The findings of this investigation, as they apply to rail rapid transit, are presented below.⁸⁶

At the outset, it should be noted that there is no need for a significant R&D effort to make major advances or innovations in ATC technology for rail rapid transit systems. The basic technology is sufficiently developed for present and near-term future purposes. What is needed now is research and development to refine the existing technology and to improve performance at reduced cost. The major elements of such a program are discussed below. Figure 73 is a matrix, categorizing the importance of these R&D efforts against the estimated relative cost to carry them out.

Reliability and Maintainability

There are several aspects of reliability and maintainability in which further work is needed.

Equipment Reliability and Maintainability

There is a major need to develop more reliable and maintainable equipment. This applies not just to ATC but other types of rail rapid transit equipment.

⁸⁶R&D needs for automated small-vehicle systems are explored in a separate OTA report, Automated Guideway Transit: An Assessment of PRT and Other New Systems, June 1975.

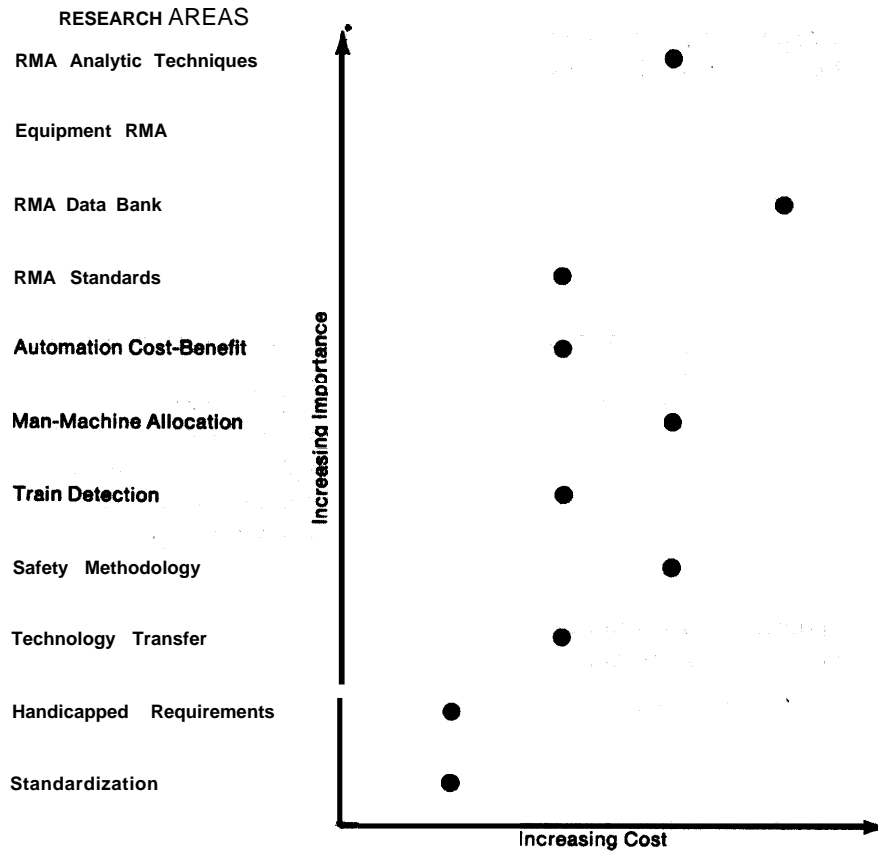

FIGURE 73. ATC Research and Development Priorities and Relative Cost

Techniques for RMA Analysis

Improved and more quantitative methods are needed to evaluate total system performance in terms of reliability, maintainability, and availability. Component performance measures exist. Total system performance measures do not. Total system measures would permit better allocation of reliability requirements among subsystems, better understanding of reliability trade-offs, and better utilization of the maintenance work force.

RMA Standards and Guidelines

An effort is needed to establish realistic equipment standards and to clarify manufacturers' responsibilities in the area of RMA. The standards must be high enough to assure reasonable availability of equipment but not so high as to make the equipment unnecessarily costly.

Reliability and Maintainability Data

A pool of data from testing and operational experience pertaining to equipment reliability and maintainability would be of great value to transit system planners, research groups, and manufacturers. At present, there is no uniform way of recording and reporting such information, and no clearinghouse for collecting and disseminating it within the transit industry.

Safety

The safety levels of the rail rapid transit industry are high and exceed nearly all other forms of public and private transportation. Still, there is a need for research in two aspects of safety.

Train Detection

The much publicized train detection problems of BART (which are probably no more severe than

those experienced in other transit systems) have underscored the need for clarification of the standard for train detection and the need for a uniform method to test the performance of train detection systems.

Safety Methodology

Controversy over system safety versus fail-safe principles abounds in the transit industry. There is also debate over how safety is to be measured and how safe is safe enough. Research is needed to develop an objective and quantified method for evaluating the safety aspects of rail rapid transit system performance.

Man-Machine Relationships

Function Allocation

There is great variability among transit systems in the duties assigned to the human operator. Significant errors were made in the original design of the BART system because of the highly passive role assigned to the train attendant. The man-machine interface needs to be carefully studied to determine the optimum role of the human operator in automated systems and to ensure that provision is made for the operator to interact effectively with the system in abnormal or emergency situations. The role of personnel assigned in a supervisory capacity needs to be similarly examined.

Cost-Benefit of Automation

Research is needed to determine the relative advantages of manual and automated methods of operation with respect to energy savings, variability of trip time, equipment utilization, system capacity, and manpower costs. Such data would be of value not only in the design of new systems but also in the modernization of old ones.

Application of Technology

Even though ATC is a rather mature and well developed technology, there remain some problems of practical application. Three areas are in need of special attention.

Standardization

There are a number of technical and economic benefits to be gained from reducing the diversity of ATC equipment now in use or planned for installation in rail rapid systems. These advantages must be scrutinized and evaluated against the disadvantages of inhibiting innovation and impeding improvement that standardization might bring.

Technology Transfer Within the Industry

There is a general shortage of persons with experience in ATC system design, manufacture, and operation at all levels in the industry. This shortage is most keenly felt by agencies planning and building new systems. Research is needed to devise more effective methods for sharing information, exchange of experienced personnel, and training of new personnel.

Requirements for the Handicapped

Under the stimulus of the Federal Government, there is an increasing concern in the transit industry with the transportation needs of the handicapped. As a part of the investigation of the general social costs and benefits of providing rail rapid transit service for the physically, visually, and auditorily impaired, there is a need to consider the specific influence of ATC. Among the matters of interest are acceleration and deceleration limits and their effects on system capacity and trip time, passenger assistance on trains or in stations with a low level of manning, and the safety of the handicapped and others in emergency situations.

Chapter 7

POLICY AND INSTITUTIONAL FACTORS

INTRODUCTION

Rail rapid transit is a public entity. Transit systems are built with public funds to serve public transportation needs. The public is involved in the conception and planning of the system—both in public referenda to approve the building of the system and in citizen participation programs during the planning process. The planning and operating agencies, themselves, are quasi-public bodies, whose directors are responsible to a State or municipal government or to a local electorate. The operation of the transit system, especially in recent years, may be subsidized with some combination of Federal, State, and local funds. As a consequence, the form and operation of a rail rapid transit system are strongly influenced by public policy and institutional factors,

Three forms of influence can be distinguished: legislative, regulatory, and institutional

Legislative influence is manifested through the content, authority, and impact of laws enacted at the Federal, State, and local levels of government. Generally, such laws serve one of two purposes: regulation or promotion. In the earliest days of public transit, and continuing somewhat after World War II, the intent was primarily regulatory. Laws were enacted to control the private firms that provided public transportation and to ensure that the public interest was protected.

Since the middle of this century, the purpose of legislation pertaining to public transit has shifted to that of promotion and subsidy. This shift was coincident with, and occasioned by, the precipitous decline of the transit industry to the point that it was threatened with extinction. As a result, most of the recent legislation has been aimed at promoting a resurgence of public transportation. These laws authorize the expenditure of public funds (often in large amounts) to design, build, and operate transit systems. These laws also establish and support research programs to advance the state of technology and to broaden its application. While none of this legislation has dealt specifically with automatic train control technology, this aspect of transit system design and operation has benefited from the general increase of financial support for rail rapid transit.

Regulation, although no longer the predominant purpose of legislation, is still a major concern at all levels of government. The oversight and control of

transit systems is an important function of Federal and State agencies, especially in the area of safety. Local governments tend to place more emphasis on the regulation of fares and levels of service. The pattern of regulatory legislation is far from static; and, like promotional legislation, it appears to be extending—especially at the Federal level—more widely and deeply into the area of system operation.

Institutional factors are manifested primarily through actions of the transit industry, labor unions, and—to some extent—the public at large. While not so clearly defined or so easy to isolate as legislation and regulation, these institutional factors also serve to shape the course of transit system development and operation.

The purpose of this chapter is to examine the issues raised by ATC in the area of public policy and institutions. In some cases, these ATC issues are not wholly distinguishable from the general context of rail rapid transit system development and operation. These larger, systemwide topics will not be treated, however, except as background to the particular aspects of ATC or the reciprocal effects that policy and institutions have on train control system technology and its application.⁸⁷

SUMMARY OF EXISTING LEGISLATION

Most of the legislation relating to rail rapid transit is of recent origin, and none contains specific provisions for the promotion and regulation of ATC per se. Nevertheless, this legislation (especially Federal laws) does have an indirect effect upon ATC design and development through the general support provided to rail rapid transit technology. The following is a summary of the Federal laws with sections germane to ATC.

Urban Mass Transportation Act of 1964 (PL 88-365)

In general terms, the Act of 1964 provided three forms of financial support:

⁸⁷For an examination of the more general policy issues pertaining to transit system planning and development, see the OTA report, *An Assessment of Community Planning for Mass Transit*, November 1975 (Report Nos. OTA-T-16 through OTA-T-27).

- Grants or loans to assist State or local agencies in acquisition, construction, or improvement of transit facilities and equipment⁸⁸
- Grants to State or local agencies for planning, engineering, and design studies related to mass transit;
- Grants for research (including new technology) and training.

Funds in all three categories have been used for development and acquisition of ATC systems. Capital grants have been made both for the purpose of upgrading existing ATC equipment (e.g., the recent cab signal installation programs in CTA and MBTA) and for planning and constructing new systems with advanced forms of train control (e.g., WMATA and MARTA). Funds available under the 1964 Act have also been used to support several ATC-related research and development activities, both within DOT and by outside R&D organizations.

The 1964 Act also contains two specific sections that have an influence on decisions related to train control system automation:

- Transit employees adversely affected by any federally assisted project must receive special consideration, including protection of rights and benefits;
- Transit systems must afford accommodation to the special needs of the elderly and handicapped.

Protection of individual workers (not specific jobs) is contained in section 13(c) of the Act. which also requires that clearance for a grant be obtained from the Department of Labor. The Act allows the elimination of jobs, but only as workers presently holding those jobs retire or vacate the positions for other reasons. Thus, economic benefits of workforce reduction through automation of an existing transit system may be deferred for a number of years until retraining, transfer, or attrition can account for the displaced workers. Alternatively, direct compensation can be paid to affected workers, eliminating the jobs earlier but at an earlier cost. As noted previously, however, it appears that few employees are actually put out of

⁸⁸Originally, the 1964 Act provided for two-thirds Federal funding, with one-third State and local matching. In 1973, the Act was amended to increase the Federal share to 80 percent.

work by increased automation of existing systems, New systems do, in fact, have smaller train crews, but this work force reduction is largely offset by the increased need for more and higher skilled workers to maintain the more sophisticated and complex ATC equipment⁸⁹.

The Urban Mass Transportation Act of 1964, and its amendments, directs that consideration be given to the means of providing service to, and assuring the safety of, the elderly and handicapped. This has raised problems that are not yet fully resolved within the transit industry. The chief concerns related to ATC are control of door operation and emergency evacuation of vehicles in automated systems without an onboard operator. There is also uncertainty about how accommodation of the elderly and handicapped will affect the service offered to other passengers in normal operations and their safety in emergencies.

Department of Transportation Act of 1966 (PL 89-670)

This Act created administrative and supervisory bodies of the Federal Government that now have a major influence on transit system development and operation as a whole, and ATC in particular. The Act established both the Urban Mass Transportation Administration (UMTA) and the National Transportation Safety Board (NTSB), UMTA is the principal DOT organization by which grants and Federal assistance to transit development are administered. NTSB is charged, inter alia, with overseeing the safety of transit systems and with accident investigation.⁹⁰

Federal Railroad Safety Act of 1970 (PL 91-458)

This Act placed the safety of rail rapid transit systems within the purview of the Federal Railroad Administration (FRA). To date, however, FRA has not actively pursued this interest, apparently because of preoccupation with problems of intercity and commuter railroads, As discussed below in Issue P-z, there is evidence within recent months of

⁸⁹See Issue O-12, beginning on page 116, for a further treatment of this point.

⁹⁰The NTSB investigation of the BART Fremont accident, entitled "Safety Methodology in Rail Rapid Transit System Development," August 1973, and an earlier report, "Special Study of Rail Rapid Transit Safety," June 1971, raised several important questions about the advantages and disadvantages of ATC.

more active involvement of FRA in rail rapid transit.

National Mass Transportation Assistance Act of 1974 (PL 93-503)

This law is, in effect, a significant amendment and extension of the Urban Mass Transportation Act of 1964. Its major provisions include allocation of additional funds for urban mass transportation programs and—for the first time—makes Federal funds available on a fifty-fifty basis for operating expenses. Under the 1964 Act, Federal support was available only for capital expenditures.

Some of the sections of the 1974 Act specifically relate to ATC are:

- Section 5 (n) The provisions of section 13(c) of the Act of 1964 are made applicable to all assistance under the formula grant program.
- Section 107 The Secretary must investigate unsafe conditions in facilities, equipment, and operations funded under the Act of 1974, which result in serious safety hazards. If unsafe conditions are found, he may withhold assistance until appropriate actions are taken.

It is still somewhat early to assess the general effects of this Act on transit system development or its specific impact on ATC. Opinion on these subjects is mixed within the transit industry and in the Federal Government, and evidence from transit system operation is still too fragmentary to indicate trends.

State, Regional, and Local Legislation

Before 1964, when the Federal Government became involved in capital grants to mass transit, financial support was almost exclusively the concern of State and local governments. Such support, when given, was usually for publicly owned systems. Private transit operators, while subject to various forms of State and local regulation, typically received no support from public funds and were almost wholly dependent upon the fare box for revenues.

As transit ridership declined and operations became less and less profitable, private operators often severely curtailed services. Eventually, many found it impossible to continue. It became necessary for public bodies to assume control in order to

prevent the total loss of these transit systems to the community.

At the State, regional, and local levels, and occasionally by interstate agreement, legislation has been enacted to set up various public or quasi-public agencies for operation of public transit systems. These organizations take a variety of forms. Some are purely operating authorities. Others also have planning responsibilities. Most control all modes of transit in their area of jurisdiction. A few (such as BART and PATCO) operate only a rail rapid transit system.

Many States have formed Departments of Transportation for the purpose of coordinating mass transit activities on a statewide basis. In large part, State DOT efforts are concentrated on obtaining a larger share of Federal funds or increasing the eligibility of local agencies to participate in Federal programs. There has also been considerable support for mass transit at the State level in the form of direct subsidies, special taxing plans, and public assistance programs such as transportation of schoolchildren and the elderly,

It is difficult to generalize about these State and local legislative structures except to indicate that the concern is primarily on the public service aspects of the system as a whole. Technological characteristics, chiefly as they relate to safety, do receive attention in those States which have a public utilities commission established to regulate transit system operation. In some States, however, the transit agency itself is charged with regulating its operation.

ISSUE P—1: IMPACT OF EXISTING LEGISLATION

What effects has recent transportation legislation by the Federal Government had on ATC development and application?

There have been few, if any, effects on ATC specifically. Like other areas of rail rapid transit technology, ATC has received general benefit from increased funding by the Federal Government to support research, development, and application for individual transit systems.

The Urban Mass Transportation Act of 1964 and its amendments has been of enormous help to the rail rapid transit industry for the planning and con-

struction of new systems and for the modernization of equipment and facilities in existing systems. The benefits of this law stem not only from the large amount of money made available by the Federal Government for capital grants but also from the incentives offered to State and local governments to participate in capital acquisition and improvement programs by providing matching funds. During the decade since enactment of the 1964 law, major improvements have been made in the New York, Boston, and Chicago rail rapid transit systems, and work on new systems has been started in Washington, D.C., Atlanta, and Baltimore.

The recently enacted National Mass Transportation Assistance Act of 1974 continues the policy of Federal support for mass transit and, for the first time, extends Federal assistance for operating costs. Under the 1964 Act Federal support was provided only for capital improvements and acquisition (two-thirds Federal funds, one-third matching State and local funds). The 1974 Act authorizes UMTA to provide capital grants (on an 80-20 basis) and operating aid (on a 50-50 basis). Table 34, a summary of the UMTA budget for Fiscal Year 1976, indicates the magnitude and distribution of the Federal Government's assistance program for mass transit.

TABLE 34. UMTA Budget for Fiscal Year 1976

UMTA PROGRAMS	AMOUNT (millions of dollars)
Capital Grants	1,100.0
Operating Aid	500.0
(Carryover)	150.0
Technical Studies	38.7
R&D and Demonstration Grants	53.4
Managerial Training	0.6
University Research	2.0
Administrative Expenses	12.5
Total	1,857.2

There is no evidence that either the 1964 Act or the 1974 Act has had a specific impact on ATC technology or its application in existing and planned transit systems. The provisions of these laws are quite general, and there is no explicit or implied support provided for ATC in particular. While there have been ATC programs undertaken with funds made available under the 1964 Act, and some proposed with funds from the 1974 Act, they represent no more than a part of the general pattern of transit

system improvement and growth fostered by Federal Government assistance,

There is a widely held view in the transit industry that the 1964 Act may have had the effect of encouraging the development and use of automated train control systems. Because the Act provided grants only for capital improvements or acquisition and not for operating assistance, planners may have been induced to concentrate their resources on capital-intensive features such as automatic train control (which would be eligible for Federal assistance) in the hope of thereby reducing later operating costs (for which Federal assistance funds were not available).

The argument is plausible, but it does not seem to be supported by events. First, the amount of money for train control systems provided by the 1964 Act has been relatively small, probably not more than 2 to 5 percent of the total capital assistance program, and it is doubtful that such an amount could have had the imputed effect. Second, the ATC projects that have been undertaken in this period and supported by Federal funding have been justified on grounds other than potential manpower savings through automation. At CTA and MBTA, for example, the justification for cab signal installation was safety of operation not labor saving. It should also be noted that the two most automated systems placed in service during the time the 1964 Act was in force (PATCO in 1969, and BART in 1972) were planned and built without expectation of Federal assistance.⁹¹ Further, the new systems in Atlanta and Baltimore, for which preliminary planning and design took place between 1964 and 1974, employ lower levels of automation than the BART system. If the 1964 Act had had the influence purported by some persons in the transit industry, just the opposite would have been expected, i.e., MARTA and Baltimore MTA would have a degree of train control automation equal to or surpassing that of BART. Thus, it seems unlikely that Federal Government policy, as expressed in the 1964 Act, has tended to foster automation.

Federal Railroad Administration (FRA).—The FRA, which has long had jurisdiction over the safety of interstate and commuter railways, has interpreted the Federal Railroad Safety Act of 1970 to

⁹¹BART did receive some Federal assistance in the latter stages of development and construction, but this was long after the commitment had been made to a highly automated form of train control.

confer upon it (through delegation by the Secretary of Transportation) authority for safety regulation of all transit systems using rail technology. To date, however, FRA has not actually exercised this authority over urban transit systems except to institute a standardized procedure for accident reporting and to announce proposed rulemaking with regard to train protection systems and the safety of door operation.

With regard to train protection, FRA is considering the possibility that cab signals and onboard automatic stopping devices should be required for all rail rapid transit systems. This requirement would apply only to new systems, and some exceptions would be granted to existing systems that have a heavy investment in wayside signals and trip stops. The concern of the FRA with door operation centers on how to prevent accidents in which passengers are caught or struck by doors. Preliminary hearings on door safety have been held and the views of the transit industry have been solicited. FRA has not yet decided the approach to be taken, but their stated intention is to regulate the force and manner of door closure and the safety interlocks between door operation and train motion.⁹²

FRA's sphere of authority is confined to the safety of equipment already in use. They are not able to exert direct control over the design process for new systems. However, the FRA can wield indirect control since they could shut down—or prevent the startup of—any new system not meeting the safety regulations in force for operating systems.

Urban Mass Transportation Administration (UMTA).—At the present time UMTA does not perform a regulatory function, in the commonly accepted sense of the term. However, some form of regulatory authority does appear to be implicit within the general responsibility of UMTA to oversee and administer funding for the development of new systems. Certain of UMTA's requirements for transit system development programs verge on regulation—for example, the requirement that transit districts requesting capital grants for new system conduct studies of transportation system alterna-

⁹²In passing, it should be noted that the FRA's concern with the safety of door closure did not arise from rail rapid transit incidents but from operating experience on commuter railroads regulated by the FRA.

tives and trade-offs. Also, the Safety Division of the UMTA Office of Transit Management has proposed initiation of a comprehensive "system safety" program, which might later be broadened to cover "system assurance." Under a system assurance program, the concerns of safety would be integrated with those of reliability and maintainability. If this is done, the domain of regulation would be expanded to include all aspects that contribute to safe, efficient, and reliable transit system operation. While local transit agencies might not be required to conduct such programs by UMTA regulation, the control of grant funds exercised by UMTA would have considerable mandatory force. In fact, several transit agencies have already instituted system assurance programs in anticipation that it might become a future requirement for obtaining UMTA grants.

UMTA may soon begin investigating transit accidents as a regular activity. Section 107 of the Act of 1974 requires the Secretary of Transportation to investigate serious safety hazards in systems whose construction or operation is financed with Federal Government funds, and UMTA is a logical choice within DOT as the agency to carry this out. However, it is intended that such investigations would be conducted only after a serious accident or incident had occurred and not as a routine before-the-fact activity.

In the past 2 years, UMTA has made use of the DOT Transportation Systems Center (TSC) to carry out in-depth investigations of ATC in two new transit systems—BART and the PAAC skybus. The former was an investigation of a newly opened system which was in the midst of controversy over the safety of the ATC system. The latter was an investigation of the proposed ATC system for a transit system still in the preliminary design stage. Of particular interest there was PAAC's intent to operate rubber-tired vehicles with no onboard personnel. At the present time, TSC is also assisting UMTA in design reviews of the MARTA transit system now being built in Atlanta. Among the areas of concern to the TSC participants are the safety aspects of the ATC system design and the effectiveness of the integration of man and machine functions.

Some members of the transit industry have expressed concern about these TSC activities. They fear that TSC might gradually assume a regulatory

function for rail rapid transit--especially by setting down rules, standards, and guidelines that might become the basis for a de facto form of regulation. UMTA's position is that, while TSC may continue to provide technical assistance, there is no intent to assign any sort of regulatory role to TSC.

National Transportation Safety Board (NTSB).—The Department of Transportation Act of 1966 created the NTSB which, while not precisely a regulatory body, has had influence on transit system safety in general and ATC in particular. The NTSB is empowered to investigate rail rapid transit system accidents (as well as accidents in other types of transportation) and to make recommendations to the Secretary of Transportation concerning procedures and equipment that affect the safety of operation. NTSB has made a number of accident investigations and special studies and has produced several significant recommendations.

One report, entitled "Safety Methodology in Rail Rapid Transit System Development" (August 1973) has engendered strong controversy because it included a recommendation for "abandonment of the fail-safe concept." The NTSB view, which is diametrically opposed to traditional railroad and rapid transit practice, has brought adverse comment from all segments of the transit industry. The report went on to recommend that, as a replacement (or perhaps more correctly a supplement) for fail-safe, the industry adopt "an organized approach to accomplishing rapid transit system safety through the application of current safety management and engineering concepts." Without entering into the merits of the NTSB argument, this report can be cited as a major impetus for the system safety and system assurance programs now being considered by UMTA.

The role of NTSB appears to be expanding. The Transportation Safety Act of 1974 contains provisions which require NTSB to conduct a much broader program of accident investigations than that set forth in the Department of Transportation Act of 1966 that established NTSB. It is estimated that this will involve over 700 additional accident investigations per year in rail transportation alone. While rail rapid transit is not mentioned specifically, NTSB will be expected to investigate all fatal railroad accidents, all accidents involving passenger trains, and all rail transportation accidents resulting in substantial property damage.

ISSUE P-2: REGULATION

What agencies regulate the development and operation of transit systems and how do they function?

There is some regulation (primarily concerned with safety) performed by a combination of Federal and State agencies, but up to now most regulation has been carried out by individual transit authorities acting as self-regulating bodies. Within the Federal Government, regulation is divided among FRA, UMTA, and NTSB.

Regulation of rail rapid transit systems is carried out at three levels of government: Federal, State, and local. In some cases, the transit system operating authority may also be self-regulatory. Until recently the concern of regulatory bodies at all levels has been essentially limited to the area of safety. Since, in the traditional view, safety involves prevention of collisions and derailments, regulatory interest has centered almost exclusively on ATP subsystems and equipment. Now that automation has been extended into train operation and supervision, the scope of regulatory agency concern is broadening to include all aspects of safety and to deal with safety on a system-wide basis. Aside from safety, other aspects of system operation (with possible exception of fare structure and level of service) have received little or no attention from regulatory agencies.

Federal Regulation

Three Federal Government agencies have partial jurisdiction over safety matters. These agencies and their areas of responsibility are described briefly on the following pages.

Under the **1974** Act, NTSB still is not vested with any rule-making authority or power to establish requirements that specific safety-related actions or remedies be effected. As before, the primary role of NTSB will be to investigate and make recommendations to the Secretary of Transportation, who will retain the authority to accept and enforce the recommendations as seen fit.

An important point with regard to NTSB recommendations, which is not always recognized by the

public, is that NTSB does not attempt to evaluate the economic or technical aspects of its recommendations. The sole concern of NTSB is to maximize the safety of a transportation system. The responsibility for evaluating feasibility and cost-benefit is left to the appropriate regulatory agency and the local authorities who must ultimately decide on a course of action.

State Regulation

In many States, regulatory bodies were created in the 1900-10 period to oversee transit operation and protect the public from the monopoly power of private owners. As such, these State agencies were almost exclusively concerned with economic regulation. With the shift of local transit systems to public or quasi-public ownership and operation in the 1940 and 1950 decades, these agencies were left with vestigial responsibilities, and some ceased to exist. Few of these State agencies, then or now, have been active in safety regulation. As a practical matter, then, most local transit authorities are self-regulated in the areas of both economics and safety,

During this study it was found that many transit authorities considered themselves to be essentially self-regulated, but perhaps subject to requirements imposed by such agencies as the State DOT or Public Utilities Commission, the State legislature, or even a regional planning commission of one sort or another. Transit systems serving areas which include the State capital appear to receive substantial attention from the State legislature, although not necessarily in the form of regulation. An example is the State of Georgia Legislature which created the MARTA Technical Overview Committee. This committee is empowered to look into any or all aspects of the MARTA system. Also, the State of Minnesota Legislature has taken an active interest in the activities of the Twin Cities MTC and, in 1973, directed that a special study of PRT alternatives be performed because they were not completely satisfied with the results of previous studies.

In some States, the public utilities commission (PUC) has had an active role in the regulation of rail rapid safety, often with specific interest in the ATC system. Two notable examples are in California and Massachusetts.

In 1967, the California PUC issued specific requirements dealing with ATC. Their coverage was somewhat general but they specifically addressed

the subject of ATC. These requirements, a result of section 29047 of the California Public Utilities Code, state that BART shall be subject to safety regulations of the PUC and that the commission shall inspect BART facilities for safety of operations and shall enforce the provisions of the section.

The Massachusetts PUC has taken an active interest in the ATC system installed on the MBTA's South Shore extension, and has ordered that fully automatic operations be restricted until such time as the PUC is satisfied that no potentially unsafe conditions exist.

Industry Self-Regulation

Regulation of a transit system by an external agency is not an easy matter. It requires establishing an organization, staffed by technically competent and experienced personnel, to write standards, review plans and designs, and conduct tests and inspections. Even if the necessary personnel could be found, it might not be practical at the State or local level to create such an agency. Typically, a State contains only one rail rapid transit system; and to establish a special authority to oversee a single operating agency might be a governmental extravagance.

For this reason, most publicly owned transit agencies are self-regulated, both for safety and economic matters such as fares and level of service. As public or quasi-public bodies, they respond to the influences of the political system by which they are created and to the economic constraints imposed by the use of public funds.

The opinion within the transit industry is that self-regulation is a workable solution. The excellent safety record of rail rapid transit is cited as proof that a self-regulating body can manage its affairs in a responsible manner, with the public interest as a foremost concern. The opponents of self-regulation, while not questioning the integrity and sense of responsibility of the local transit system officials, point out the inherent danger of vesting a single agency with the authority to conduct transit operations and oversee the results. Both sides of the argument have merit, and one of the basic issues in the area of public policy for rail rapid transit is to find a proper balance between external regulation by a State or Federal agency (or some combination thereof) and responsible management by the local operating authority.

ISSUE P-3: ACCEPTANCE TESTING AND QUALIFICATION

What part is played by regulatory bodies in the testing and qualification of ATC systems?

Except for the public utilities commissions in certain States, regulatory agencies are seldom involved in testing and qualifying a system for initial service. Up to now, the Federal Government² has not taken an active role in this area.

Before a transit system is placed in service, each of its major components and finally the system as a whole must be subjected to acceptance and qualification tests. Customarily, this testing is carried out by the engineering staff of the operating authority, often with the assistance of technical consultants and manufacturers' representatives. The State regulatory agency (typically a public utilities commission) may observe some part of the tests and may receive the results for review, but the State agency usually does not take an active role in testing and rarely, if ever, conducts independent tests to verify that the system performs according to standards. Regulatory agencies of the Federal Government (FRA, UMTA, and NTSB) are not involved at all in acceptance and qualification testing, and they do not perceive that they have a legislative or organizational mandate to do so.

Thus, with regard to testing and qualification, local transit authorities tend to follow the pattern of self-regulation. The reasons are primarily those of practical necessity and not explicit Government policy. Automatic train control equipment, like most other components of a modern transit system, is complex and technologically sophisticated. For a local or State agency to conduct tests of this equipment would require a staff of technicians trained in the use of sophisticated instrumentation and experienced in train control system operation. In view of the general shortage of such qualified personnel in the transit industry, State agencies find themselves in a position where they must compete with the transit authority, manufacturers, and consulting firms for the few persons available. Further, State agencies may be at a competitive disadvantage because they cannot offer the salaries, prestige, or opportunities for advancement that are available in an operating transit organization, a manufacturer, or an engineering consultant firm.

Scarcity of technically qualified personnel is not the only reason. The program of testing necessary for a local or State agency to qualify a system for service is virtually the same as the test program normally pursued by the operating authority itself in assuring that the equipment performs according to specification and manufacturers' warranty. Because of this, public agencies have been reluctant to establish separate organizations to engage in efforts that would largely duplicate those of the operating system they are charged with regulating, especially since there may be only one transit system within the entire State. And even if the regulatory agency were willing to do so, it might be difficult to convince the State government and legislature that such would be an effective and necessary use of public funds.

Most State agencies have found that the practical course is to monitor the tests conducted by the local operating agency and to review the findings to assure conformance with established standards, either those of the State agency or those of the transit industry generally. In some instances, the State agency has entered into a cooperative arrangement with the local transit authority, whereby certain tests are conducted by the local authority on behalf of the State or whereby State standards have been adopted by the local agency.

In passing, it should be noted that the primary, and almost sole, concern of State regulatory bodies is the safety of the system, specifically the design features that prevent collisions and derailments. The broader aspects of passenger safety and operational concerns such as reliability and availability are almost never matters of regulatory action,

The history of the transit industry has shown that, because of their size and complexity, new systems are almost never completed by their scheduled opening date. As deadlines are missed, public impatience and political and economic pressure mount. Because acceptance and qualification testing is usually one of the last items on the schedule, the local operating agency is strongly tempted to shorten the test program or to defer a part of it until after the system has opened for service. The State regulatory body, influenced by the same pressures, may find it necessary to acquiesce,

To assure that acceptance and qualification testing is not slighted in these circumstances, some have suggested that the Federal Government (through either UMTA or FRA) should require a

ISSUE P-4: STANDARDIZATION

What effects would standardization have on ATC?

There would be both positive and negative effects. The benefits of a uniform technology lie in the areas of improved system assurance and reduced research and development costs. The major disadvantages are restrictions on innovation and limited freedom of choice in system design.

Few fields of technological endeavor run the full cycle from experimentation to mature development without the introduction of standardization. At some point, the establishment of design and performance standards becomes desirable to check proliferation of design variations, to reduce development costs, to limit technological risk, and to assure that best use is made of existing technology. The real issue is not whether to standardize, but when and to what degree. If standards are imposed too early or too rigidly, innovation and technological improvement may be stifled. If too late, the variety of designs may be so great that the standards become meaningless, and there may be economic hardship for those who own or manufacture equipment that lies outside the prospective standard.

At this time, the matter of standardization of ATC is an open question. Some argue that it would be healthy for the transit industry and the general public whose tax moneys are used to support the development and installation of new ATC systems. Others contend that it would be unwise to standardize now at a time of great experimentation and innovation because many promising avenues of improvement might be cut off. The following is a brief examination of three areas where standardization might be most applicable,

Procurement Specifications

As ATC equipment has become more complex and sophisticated, the specifications governing the design and procurement of this equipment have grown more detailed and explicit with regard to system performance and contractor responsibilities. At the present time, however, each transit agency procuring a new system or upgrading existing installations writes a more or less unique specifica-

certain amount of testing before a new system is put into service. It is argued that only the Federal Government has the authority and the resistance to local pressure required to ensure that the interest of public safety is not compromised by expediency. There is also an economic justification advanced. The Federal Government, having provided as much as 80 percent of the funds for development and construction, has the major interest in the new system and should assure that full value has been received for the investment of public moneys. A third, and purely practical, reason for Federal Government involvement is that only at the national level would it be feasible to assemble and maintain a technical organization capable of carrying out such tests.

There are strong counterarguments. As a matter of policy, it is debatable that the Federal Government should enter into an area where State agencies and local self-regulation have traditionally ruled and where the general adequacy of such regulation has been demonstrated. Further, it may not be correct to view financial support of local transit system development as an investment by the Federal Government. Rather, it may be an instance of revenue sharing without the Federal Government acquiring proprietary interest. On practical grounds, the imposition of Federal-level requirements for testing may add unnecessary delay to the acceptance and qualification process because of the need to submit test plans to a Federal Government agency for approval, to have the test results reviewed, and to obtain additional authorizations to open the system for service. There is also the possibility that, if disputes arise between the local transit authority and the Federal Government agency, the acceptance and qualification process might be even further protracted.

The unresolved issue of responsibility for acceptance and qualification testing is part of the larger question of how and by whom should regulation of transit systems be accomplished. The question is not, of course, confined to the subject of ATC; it applies to all aspects of transit systems development and operation. Still, the matter of acceptance and qualification come most sharply into focus in the area of train control systems because of the vital part played by ATC in passenger safety. There is a clear and present need to assure, by some combination of local, State, and Federal regulation and supervision, that technology is used wisely in the public service.

tion, tailored to local needs and conditioned by their individual experience with ATC,

There would be an advantage for all if there were a uniform set of terms, conditions, and procedures for the transit industry. This might take the form of a model specification, establishing a standard terminology and defining basic methods for verifying compliance. A model of this sort need not be a completely rigid document; there should be room for variation to accommodate local needs and concerns. Further, the specification would not establish uniform performance requirements; these would be left to local decision. But it would standardize the phrasing of these requirements and set forth a universal method for acceptance. and qualification testing.

This approach would offer several advantages. It would assure that a well-thought-out document was available to the planners and directors of new systems for guidance in an area where they might be lacking in experience. It would help assure that the best of past experience and current practice is incorporated in new systems. There would also be advantages for ATC equipment manufacturers since a standard set of requirements and procedures would permit contractors to know exactly what is expected of them and would provide continuity and regularity from one procurement to the next. For the public, standardization might lead to benefits such as reduced engineering and development costs and elimination of some subsequent operational problems.

Against these advantages must be set three major disadvantages. A detailed specification is of questionable value for simple procurements; it might result in overly elaborate and unnecessarily expensive provisions without materially enhancing the quality and performance of the equipment. It may not be possible, at the present state of technology and specification writing, to produce a document with sufficient generality to cover all situations and still exercise meaningful control over the details of design and performance. Finally, there is some question whether the methodology of system assurance is sufficiently well developed and precise to permit its application to ATC systems.

ATC Characteristics

There is a tendency for the planners and developers of ATC systems (and transit systems generally) to design to their unique goals and re-

quirements. In some cases, this is justified; non-standard solutions are needed to meet special local problems and conditions. In other cases, however, it is not clear that the additional benefits of a special-purpose design justify the increased costs. Increased standardization of ATC system equipment offers the promise of substantial economic and operational benefits. On the other hand, there is the risk that standardization could inhibit innovation and technological progress. The major arguments for and against standardization of ATC equipment characteristics are enumerated below.⁹³

The standardization of ATC equipment characteristics could produce several positive effects. It would tend to reduce the variety of designs and the proliferation of special-purpose equipment. It would help assure use of the best of proven technology in new systems. Commonality of equipment would make it easier to obtain and stock spare parts (an important consideration for small transit systems). Standardization could lead to some savings in equipment engineering and acquisition costs, and perhaps substantial reduction of debugging costs (which are higher for new designs than for already proven equipment).

There are some possible negative effects of standardization. There is such a wide range of technology now in use in existing systems that it would be difficult to establish a common core of ATC equipment characteristics. There is no one type of design that is clearly superior to others or that is applicable to the broad range of conditions that exist in transit systems. Freezing design characteristics at this time, when there are some promising innovations just coming on the scene, may minimize the opportunity for technological progress. The decision to select a particular system or systems as standard might work a hardship on those who use or manufacture "nonstandard" equipment and might adversely affect industry competition.

Test Procedures for Train Detection

The basic and proven method of train detection is the electrical track circuit. While the track circuit is highly effective and reliable in most circumstances, there is a long history of difficulty with

⁹³Note that the area of standardization is ATC equipment characteristics, not components or specific designs. Component and subsystem design could be improved and refined (for example, to increase reliability) while still retaining the same fundamental characteristics.

electrical train detection on little used track where rust and film may build up and inhibit rail-to-rail shunting by the train wheels and axle. The experience in BART has brought this problem to the forefront of attention in the transit industry, but it, has existed in the background for years in other transit systems. Many in the transit industry believe that is a need for a redefinition of the performance standards for train detection circuits and for improved testing methods.

Standardization of test criteria and procedures would have the primary advantage of providing a uniform and objective way to verify the performance of train detection circuits and would thereby assure that effective train protection is achieved. This would have also a secondary benefit, in that a potential source of misunderstanding (and litigation) between the buyers and sellers of ATP equipment would be largely eliminated. However, there are some offsetting disadvantages. The problem of train detection is so complex and influenced by so many extraneous variables that it may not be possible to develop a single, universally applicable standard and testing method. Even if such a standard and test could be devised, it might prove to be overly conservative and could lead to excessively complex equipment or unnecessarily redundant mechanisms.

ISSUE P-5: SAFETY ASSURANCE

Is action by the Federal Government ***needed to*** ensure the safety of ATC design and ***operation?***

Federal action may be required to establish safety standards, methods of measurement, and testing procedures. Many in the transit industry believe, ***however***, that ***such could be*** brought about internally by the process ***of self-regulation.***

As noted in the discussion of Issue P-z, Regulation, most transit systems (both operating and planned) are essentially self-regulating in matters of safety. While many members of the transit industry recognize the need for improvement in safety standards and methodology, they believe that the safety record of rail rapid transit demonstrates the effectiveness of self-regulation and that direct action by the Federal Government is not required. They also argue that local self-control, while

perhaps not an ideal method, is preferable to intervention by a Federal agency because the local officials are much closer to the needs and problems and more likely to be responsive to the concerns of the public in the area served. This position is not strictly a "hands-off" policy. Many local transit agency officials feel that the Federal Government could be of substantial help in the matter of safety assurance, but primarily in a supportive and advisory capacity and not in the role of a direct regulator.

There are, of course, counterarguments. The increasing complexity of transit systems (and the ATC equipment that controls train movement) has greatly magnified the difficulty of insuring that all elements are safe and reliable throughout the life of the system. The task of safety assurance may thus have grown beyond the capability of a local operating agency to deal with it systematically and effectively. Perhaps only an organization at the national level could command the resources and have the authority to cope with the problem. Perhaps also, only a national organization could be expected to develop a sufficiently uniform and impartial set of standards to ensure that safety matters are handled equitably and consistently throughout all the transit systems in the country. If a transit system is considered not as a local public utility but as part of the national transportation resources, then Federal regulation can be further justified on the grounds that the Federal Government is the only body capable of overseeing the service of national interests.

If external regulation of rail rapid transit safety is deemed necessary, there are three principal matters that need to be addressed: safety standards, methods of measurement, and testing procedures.

Safety Standards

How are the elements of an ATC system to perform under normal and abnormal conditions? What are the requisite fail-safe characteristics of ATC systems? What level of protection must be provided for passengers, train crew, and equipment in the event of failure or malfunction? And finally, what degree of risk must exist before a system or situation is considered unsafe?

Methods of Measurement

There is a need for common definitions and methods of measurement. It would be of little value to standardize ATC systems and to develop a general ATC system specification without also

defining what characteristics are to be measured and how such measurement is to be accomplished.

Test Procedures

The procedural aspects of testing need to be given attention, Uniform procedures would help assure that testing gives valid results and that no important aspect of system performance is overlooked. Uniform procedures would also help guarantee consistency of treatment and evaluation for all transit systems in the country.

ISSUE P-0: PUBLIC EXPECTATIONS

What is the level of public expectation with regard to the safety, dependability, and cost of ATC systems?

The evidence is sparse, but it seems to indicate that the area of highest public concern is safety. The public also appears to expect a high degree of dependability. The costs of ATC are not differentiated from those of the transit system as a whole.

There is almost no information available on the attitudes of the riding public toward transit systems. Judging from newspaper coverage and individual expressions of public opinion through the news media, the public tends to take a transit system for granted until some specific problem occurs. When it does, public reaction is likely to be negative and narrow in focus, centering around the incident itself and ways to prevent recurrence. Public concern is seldom of long duration and recedes as the normal pattern of transit operations is once more established and memory of the incident is eclipsed by other interests.

Transit system operators believe that the public is primarily concerned about personal safety while riding the trains and about security from robbery and crimes upon their person. Again, however, the level of safety (i.e., the number and frequency of accidents and injuries) is such that public concern about personal risk comes to the fore only when a mishap occurs. The case of BART is a classic example. Before the Fremont accident, there appeared to be an unspoken acceptance of the safety of the ATC system. The public reaction to the accident was prompt and widespread (even outside the San Fran-

cisco area), but it was greatly out of proportion to the degree of actual injury and damage. Since then the public concern over safety seems to have subsided to an insignificant level and revives only momentarily in response to some new safety incident or publicity surrounding the ongoing engineering tests of the BART system. Transit operating officials in other cities such as New York, Chicago, and Boston remarked during the course of this study that the same pattern of public concern for safety is manifested there in response to accidents and mishaps.

Closely allied to safety in the public mind is the matter of security from criminal acts while riding trains or waiting in stations. Public concern does not seem to center on ATC as such, but rather on the amount of protection afforded them by transit system personnel and police and on the availability of assistance when needed. That is, the public does not take a stand against ATC because it would reduce the level of manning of the trains (and perhaps the stations). Rather, the concern is with the measures that may be employed to compensate for the absence of crewmembers.

An interesting demonstration of the public's views took place in Denver, where a system of small unmanned vehicles was proposed. During public hearings, numerous questions were raised about how muggings and assaults could be prevented or discouraged, what form of monitoring would be used, and what actions would be taken after detection of a crime. The suggestion that vehicles could be monitored by central control "listening in" by two-way radio was considered by some as a form of eavesdropping, and therefore unacceptable.

There seems to be a general feeling that transit systems should be safer than the general urban environment. Crime rates in transit systems are generally lower than in the city at large, and yet the fear of criminal acts seems to be higher in subways than on the streets. Paradoxically, efforts by transit authorities to increase the security of patrons is sometimes a two-edged sword. The presence of transit police may be reassuring, but it may also give the impression that the transit system property is so dangerous that extensive policing is necessary. NYCTA is a case in point. This system has a very large transit police force that actively patrols trains and stations, and yet public concern over "crime in the subways" is perennially high.

With regard to the dependability of service, the public does not usually distinguish the role of ATC from that of other elements of the transit system. Either the trains run on time or they don't. If there are delays or habitual disruptions of service, the public is most likely to lay the blame on management in general rather than any particular component of the system. Also, it seems that the public does not regard lack of dependability as so serious a matter as safety. Nevertheless, the public does cast its negative vote. With the instant dependability of the automobile ever present, public dissatisfaction with transit service usually takes the form of patronage diversion from public to private transportation. Transit system managers, on the other hand, regard dependability as virtually coequal to safety as a way of attracting public patronage. It is perhaps for this reason that transit system publicity tends to

stress the speed, convenience, and dependability of mass transit in their advertising to attract riders.

The public attitude toward cost is most diffuse and hard to isolate. If the individual citizen is a member of the fraction of the population that patronizes rail rapid transit, he pays the fare but probably does not think about how the costs are distributed. For the rest of the public the costs of constructing or supporting a transit system (or any specific part such as ATC) is indirect, ill-defined, and probably unnoticed. Where there is public reaction to the cost of a transit system, it usually is in general terms and in connection with a public referendum on the issue of transit system development bonds or taxation. On such occasions, the cost of ATC specifically is submerged in the total cost of the system.

APPENDICES

TRAIN CONTROL SYSTEM FUNCTIONS⁹⁴

Train control is the process by which the movement of rail rapid transit vehicles is regulated and supervised to assure safety and efficient operation of the system. Such control can be effected by manual means, by automatic devices, or by some combination thereof. The description of train control system operation presented below is cast in functional terms that apply equally to manual or automatic forms of control. Because automation is the central issue of this report, the discussion also includes an examination of the relative merits of man and machine components. A discussion of the technology of automatic train control is presented later, in appendix B.

The train control system is comprised of elements that perform four major types of functions:

- Train protection
- Train Operation
- Train Supervision
- Communications

TRAIN PROTECTION

The sole purpose of the train protection system is to assure the safety of vehicle movement by preventing collisions and derailments. Traditionally, the train protection system is functionally separate and distinct from other elements of the train control system; and it is designed so as to protect not only against failure of other system elements but against failure of its own elements as well.

Before taking up specific train protection functions, it is necessary to consider the general concept

of train protection and its role in the overall scheme of system operation.

Figure A-1 is a conceptual representation of train protection functions in a typical rail rapid transit system. The indicated functions might be performed by men, machine, or both; and they might be performed by elements in locations other than those shown in the diagram. Since the purpose of the illustration is simply to indicate functional relationships, these different forms of implementation can be ignored for the moment.

The train supervision system may generate a request for the movement of trains or switches. Some of the requested moves may be unsafe. It is the responsibility of train protection system to insure that only safe moves are carried out. In order to do this, it is necessary to know the status of switches, the location of trains, and the allowable speeds for trains as affected by track limitations and the presence of other trains in the system.

Wayside logic typically performs the route interlocking function by processing information on the desired action, the location of trains, the status of switches, and the allowable speed of trains. Output of this logic consists of safe commands to move switches and safe speed commands issued to trains.

Excluding certain track and train surveillance functions, the primary concern of the onboard train protection system is the restrictive control of the propulsion and braking system. Essentially, train protection enables or inhibits the performance of certain propulsion or braking actions. Train protection determines actual train speed and compares it to the commanded safe speed. If the train is exceeding the commanded speed by a predefine amount, action to override all other less restrictive propulsion and braking functions is initiated. Similarly, the status of critical elements on board the train as well as certain conditions on the track are used to determine what action should be taken regarding the propulsion and braking system.

⁹⁴This appendix is based on material originally prepared by Battelle Columbus Laboratories in support of the OTA study. The editors gratefully acknowledge the contribution of Battelle Columbus Laboratories but accept full responsibility for the version presented here and for any alteration of content that may have been introduced in condensing and editing the material for publication.

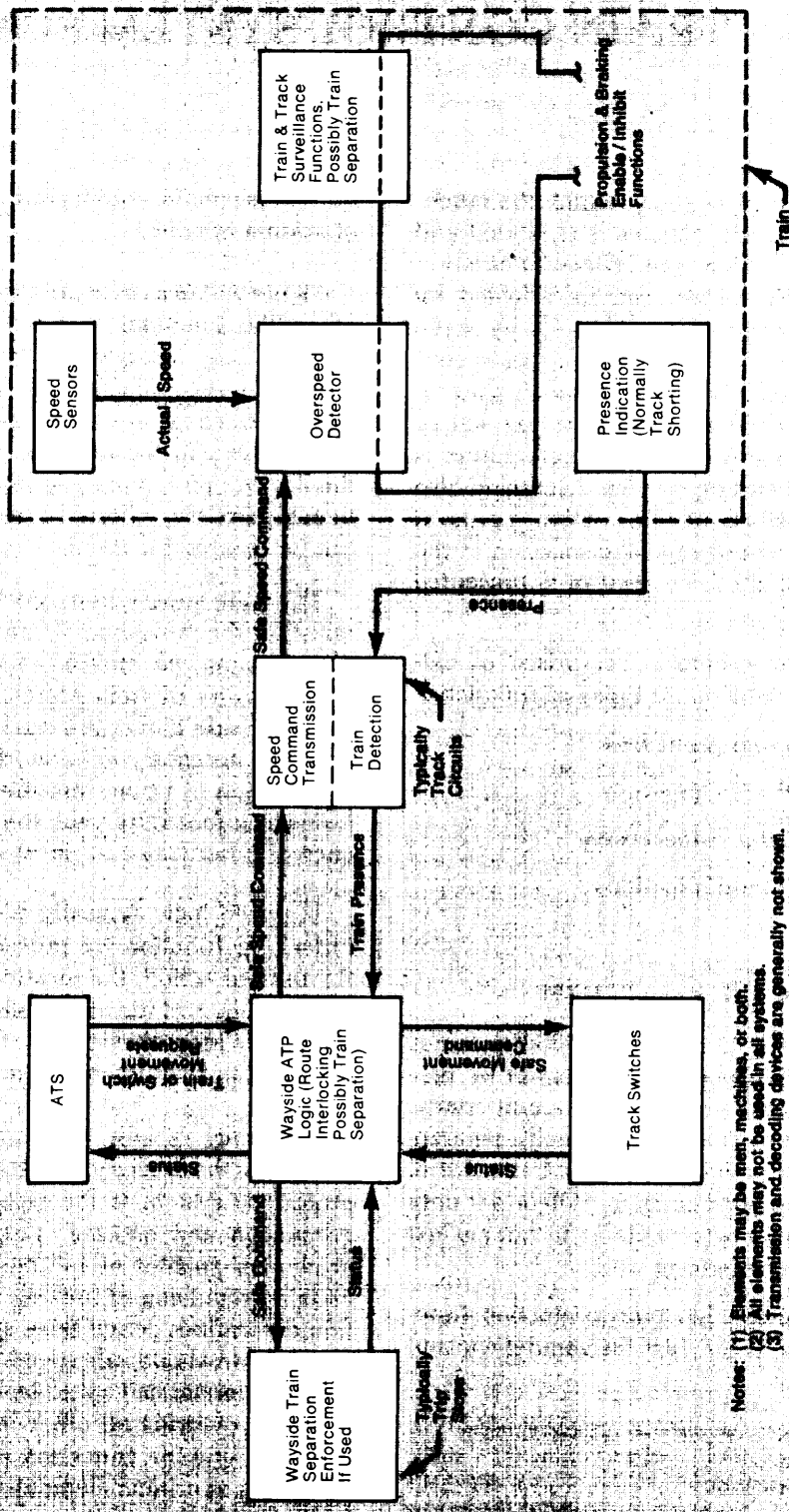

Notes: (1) Elements may be inert, mechanical, or both.
 (2) All elements may not be used in all systems.
 (3) Transmission and decoding devices are generally not shown.

FIGURE A-1.—Conceptual Diagram of an ATP System

Train and Track Surveillance

Train and track surveillance involves monitoring the train, the track, and areas immediately adjacent to the track for safety-related conditions. It can also involve monitoring adjacent tracks and trains operating on them. Passenger security, though clearly a safety-related matter, is not usually considered a part of the train and track surveillance function. Door monitoring and control, another safety-related function, is considered here to be a train operation function.⁹⁵ Train and track surveillance are essentially human roles in all operating rail transit systems today, but the amount of human involvement varies widely.

Train surveillance is concerned with monitoring the status of the train and its passengers. Onboard operators (motormen and conductors) traditionally perform this role. The primary advantage of the human in such a role is his ability to comprehend and interpret many diverse types of inputs. Except at PATCO and on the MBTA Green Line, the operator of a train is typically confined in a space that is physically removed from the passengers. His primary role in train surveillance is monitoring the status of the equipment. Conductors, if present, have more freedom of movement and can sometimes go to the scene of a possible problem to determine its nature and severity.

Passengers may provide some train surveillance functions. In systems where they can communicate with employees, they may report onboard conditions. Two-way communications systems are provided at Sea-Tac and AIRTRANS, where the vehicles are unmanned. It is likely that passengers could become more involved in train surveillance in automated small-vehicle systems.

Onboard operators provide the track surveillance function at all operating rail transit properties. In the closed environment of Sea-Tac, essentially no track surveillance is performed. At AIRTRANS, another special environment, only minimal track surveillance by roving employees is provided.

Under ideal conditions, little, if any, track surveillance would be required. Humans external to the system cause most of the problems requiring track surveillance. Trespassing, vandalism, and suicide attempts are three of the most commonly

cited factors which make some form of track surveillance necessary. Here again, the human is unsurpassed in the ability to identify and deal with a very broad range of track surveillance problems.

While a human can act to prevent some accidents, he cannot prevent all of them, partly because he simply cannot stop the train in time. If one were to assure an instantaneous response and brake application along with a rather high braking rate of 3 mph/s, it can be calculated that the minimum stopping distance from **60** mph for a typical train is **880** feet, and 220 feet at 30 mph. Clearly, there are many situations in which the potential hazard is either not visible at this distance or is created within the stopping distance of the train, (Suicide attempts are the classic example here.)

Damage assessment is a track and train surveillance function which can be performed by humans. When something has happened, a human can assess the damage to track or train and determine if it is safe to proceed.

Train Separation

The function of train separation is to maintain physical separation between following trains so that they are not in danger of colliding with each other. In the simplest manual system, train separation can be provided by the operator who drives the train much as a person drives an automobile. He must know the maximum safe speed with which he can approach curves and other places of limited visibility, and he relies upon seeing the train ahead and taking appropriate action to prevent a rear-end collision.

Figure A-2 illustrates the basic principles involved in automating the train separation function. The dashed line indicates the theoretical speed-distance relationship that a following train could maintain and still be able to come to a stop before reaching the end of the train stopped ahead.

When a block-type detection and speed command system is used, the location of the train within a block is not known accurately. Therefore, the train must be assumed to be in the most hazardous location, i.e., at the rear of the block. In the example shown, the train is almost out of block BC but must be assumed to be at the location shown in dotted lines. The shift of the theoretical speed-distance profile can be seen to be essentially one block long. In general, the shorter the blocks, the closer the attainable spacing between trains.

⁹⁵Some transit engineers consider door control to be a train protection function because of its relationship to safety.

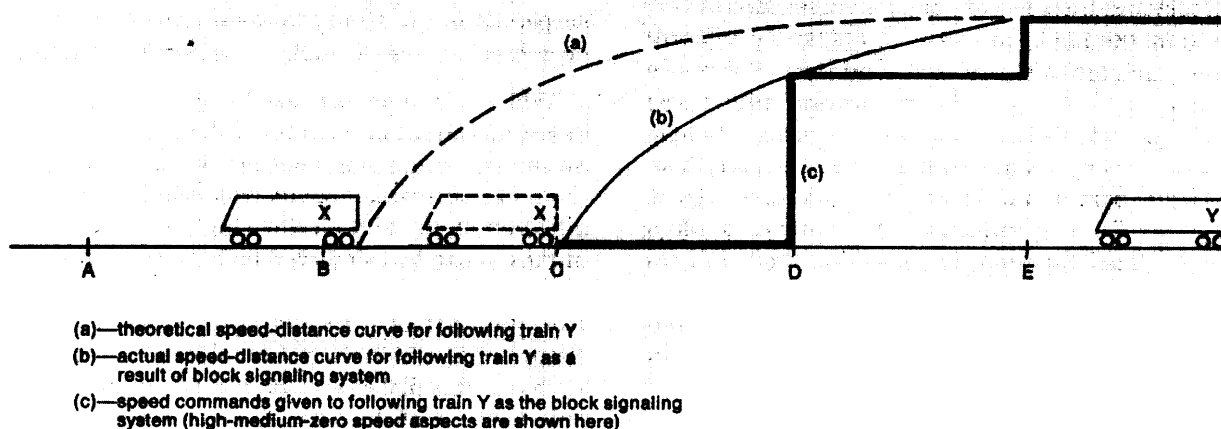

FIGURE A-2.—Train Separation in a Conventional Block Signaling System

Many arrangements of speed commands are possible. For example, if the commands were only stop or go, all signals shown (except perhaps the ones at A and E) would indicate stop. It is frequently desirable for operational reasons to have a train approach closer than the safe stopping distance from full speed. In such a case, an intermediate speed command would be provided, as shown in the block DE. A train traveling in this block would receive an intermediate speed command followed by a zero speed command from point D. One can readily see that the shorter the length of blocks and the greater the number of speed commands, the more closely a train can follow the theoretical speed-distance profile. Obviously, the system for accomplishing this becomes more complex and expensive as block length is shortened.

It should be noted that a number of factors used in the actual design of a system are not shown in this simple illustration. There is some system response time involved before braking is initiated. Grades may reduce the actual effectiveness of the brakes. No safety factors are included. Some systems provide additional blocks between trains. All these tend to further increase the spacing between trains.

The difference between intermittent and continuous speed command transmission can be seen here. Suppose the train is moving and, in a brief increment of time clears block BC. Block CD will im-

mediately indicate the intermediate speed and block DE will go to full speed. If a following train were just a few feet into block DE when the speed command in that block changed, the operator would have no way of knowing it if the speed command were transmitted by a visual signal located at E. He would have no indication of a change in signal status until the signal at D became visible. By contrast, the continuous, or cab, signal would immediately indicate to the operator that he could increase his speed. An additional advantage of cab signals is that a train can move into block DC to stop whereas, with wayside signals and trip stops, the train would stop at D, or even farther back.

All rail transit systems to date have been designed on the assumption that a leading train is either stopped or will stop instantaneously. It can be seen that trains could follow one another much more closely if a less stringent assumption could be made about the stopping of a leading train. This is precisely what is proposed in many short-headway PRT systems where position, velocity, and acceleration of a lead vehicle would all be considered in establishing headways. Some studies of PRT headway have shown, however, that removing the brick-wall concept reduces minimum achievable headway by only a small amount.

So far as is known, there are no rail rapid transit systems planning to abandon the traditional train separation philosophy. The major differences in

train separation practice are associated with the way in which train separation commands are enforced, Intermittent or wayside signaling systems provide train separation by use of trip stops.⁹⁶ Continuous or cab signaling systems enforce train separation using onboard equipment. A safe speed command is transmitted to the train and equipment on board insures that the operator initiates action to slow the train as appropriate.

Humans play a role in train separation under at least some situations. In some locations, operators are permitted to approach trains ahead of them more closely than would be permitted by the signal indication, This is always done under strict procedural controls. It maybe done at highly congested stations or in emergency situations. Practically speaking, the maneuver is identical in nature to driving one bus up behind another bus which has stopped.

Route Interlocking

Route interlocking is the process by which trains are prevented from making conflicting moves, i.e., moves that would be unsafe. Typical conflicting moves are those which would cause a train to collide with another train, to go off the end of the track, or to run through an open draw bridge. Route interlocking involves monitoring the presence and position of the trains in a system and the positions of the track switches. The information from the monitors is processed by logic, usually the front contacts of vital relays, and used to inhibit or permit the movement of the trains. As an example, when a train is dispatched from one location to another and the trip involves passage of the train through one or more track switches or crossovers, the route interlocking allows the train to proceed through the switches and crossovers only when it is safe to do so and prevents other trains from entering the route until the first train has safely passed.

Information on the presence and location of the trains is obtained from the train detection system,

⁹⁶A trip stop is a mechanical device which is located near or between the running rails; it is associated with a wayside signal. When the wayside signal indicates that a train is to stop, the trip stop is positioned so that it will apply the brakes of any train which attempts to pass the wayside signal. When the wayside signal indicates that a train can proceed, the trip stop is mechanically positioned so that it does not affect the brakes of a passing train. Thus, the trip stop enforces a stop command presented by the wayside signal.

as described earlier. Information on the status and the position of the track switches is monitored by the route interlocking. Before a route is alined for a train, it must be determined that the proposed route will not be in conflict with an existing route for another train. If no conflict exists, then the appropriate track switches must be positioned and their positions verified. Then each switch must be immobilized and locked until the passage of the train has been verified. These precautions are necessary to insure that the switch positions are not changed after the route has been alined and to insure that a switch is not moved under a train. Either of these events would be unsafe.

Route interlocking is an essential part of the train protection for all but the most simple transit systems. As system complexity increases, route interlocking assumes greater importance. Early route interlocking functions were often accomplished through the use of complex mechanical devices which prevented establishing potentially hazardous switch positions. Some such equipment is still in use. New installations are all equipped with electrical or electronic logic which, may also permit remote actuation of switches and signals.

Overspeed Protection

Overspeed is the condition where the actual train speed is greater than the intended or commanded speed. Overspeed can be dangerous because the train may derail if it goes too fast around a curve or the train may have a collision because it is going too fast to stop within the available distance. It is the responsibility of other train protection system elements to determine the allowable safe speed and to assure that the commanded speed does not exceed the allowable safe speed.

Basically, overspeed protection has two inputs and one output. The inputs are commanded speed and actual speed. A signal enabling or inhibiting the propulsion and braking system is the output. A comparator, either a man or machine, compares actual speed with commanded speed and determines if propulsion power can be applied or if a brake application is required. The overspeed protection function can be accomplished on board the vehicle or through the use of wayside equipment.

All transit systems that use cab signaling also have automatic overspeed protection. In order to do this, it is essential that the onboard speed measuring and comparing device have a virtually zero prob-

ability of failure in an unsafe mode, Even though single tachometers traditionally have been regarded as “fail-safe,” redundant tachometers are sometimes used. The outputs are compared, and if disagreement exists, a failure is assumed to have occurred and the overspeed protection logic treats this as an overspeed condition. A more frequently used approach, though, is a fail-safe speed measurement system not requiring redundancy that reduces reliability y.

It is not uncommon for a cab signal display to fail without failure of the overspeed protection system. Under such conditions, the operator can run the train safely but may have difficulty in maintaining the desired speed without exceeding the overspeed limit, The audible warning devices that are normally provided permit the operator to run without cab signals without receiving a penalty brake application.

OverSpeed can be detected and controlled from the wayside. Through the use of timing circuits and known lengths of track, it is possible to determine if the average speed of a train over a certain distance is equal to or less than the allowable safe speed, If the measuring distance is short, an essentially continuous overspeed protection can be provided, If the measuring interval is long (say tens or hundreds of feet), only an average measure can be obtained, so the instantaneous value could exceed the intended limit,

TRAIN OPERATION

Train operation consists of three major functions:

Velocity Regulation

Station Stopping

Door Control and Train Starting

In the traditional concept of signaling, train operation is not considered a safety-related aspect of train control. However, there are some safety aspects of train operation. If abrupt starts, stops, and changes are made, passengers may be thrown down and injured. If door control is assumed to mean the monitoring of the status of the train doors, passenger safety is also involved,

There is some disagreement among train control engineers concerning the functional relationships among train operation, train protection, propulsion, and braking systems, Some consider control of jerk,

slip-slide, and flare-out as train operation functions; others consider them to be propulsion and braking functions. Some consider door control a part of train protection (because of its relation to safety); others place door control within the province of train operation. These subjects will be touched upon briefly below.

Velocity Regulation

Overspeed protection is designed to prevent a train from going too fast. Velocity regulation is concerned only with controlling the speed of the train in response to operational needs. Velocity regulation systems are “nonvital,” that is, they are not essential to the safety of the system.

Velocity regulation may be accomplished by a man or machine, When a man acts as the controller, he simply compares the actual speed with desired speed and tries to minimize the difference between the two. The desired speed may be presented in the form of wayside or onboard displays. Actual speed is determined from speedometers on board the vehicle, A human controller uses a handle of some sort to control speed much as an auto driver uses an accelerator pedal. In such a system, the hand on the handle is the interface between the train control and propulsion and braking systems.

A machine controller performs exactly the same functions as a man, but the control signal is provided in the form of an electrical signal to a controller in the propulsion and braking equipment. Most ATO systems to date have provided this signal in a combined digital and analog form. The system designed for WMATA uses a completely digital interface,

For operational reasons, it is sometimes desirable to modify the speed of the train. This is usually called performance level modification, Here, a command (verbal, visual, or electrical) is transmitted to the train telling it to run at a selected fraction of the commanded safe speed. Performance level modification is not a safety-related function.

Performance level modification is normally accomplished on board the vehicle. In manual systems, an operator may receive a verbal or visual instruction to operate the train at reduced speed. In some systems, notably NYCTA, performance level modification is not normally used, Trains are held at stations rather than operated at slower speeds between stations, Both BART and WMATA pro-

vide transmitters in stations and at other critical locations to send performance level requests to the train. Performance level modification is thus accomplished automatically without operator intervention. Baltimore is considering a performance level modification system in which a visual wayside display is provided to an onboard operator who then manually sets the desired performance level for the next segment of the trip.

There is a general trend toward the use of automated velocity regulation. The two newest systems in operation (BART and PATCO) employ automated speed regulation, NYCTA is planning to install it (and other features) over a long period of time with the objective of eliminating the conductor, MBTA has installed velocity regulation on the new portions of the Red Line. CTA, however, opted not to use automated velocity regulation on its new cab signaling installation.

Station Stopping

Station stopping involves bringing the train to rest at a selected location along a station platform under some form of programmed control. It is not technically a safety-related function. Both humans and machines perform the station stopping function.

In manually operated systems, the operator normally uses some reference mark as an indicator of the point where he should initiate braking. This mark may be any wayside object, possibly a marker placed for the specific purpose of braking reference. A skilled human can ordinarily stop a train within an accuracy of a few feet. Variability in train weight, performance characteristics, and track conditions affect the human's ability to stop a train precisely. The required deceleration rate also affects his performance. The higher the average rate, the greater the variability in result.

The degree of sophistication of automated program stop equipment is a function of the accuracy required. PATCO utilizes two "triggers" spaced some distance away from the station as reference points for programmed stopping. The first trigger initiates maximum-rate deceleration. A second trigger, roughly at the end of the platform, causes the ATO package to measure the train's speed and adjust the deceleration rate accordingly. A manually set switch in the train cab is used to define train length so that the braking action will

cause the train to be centered on the platform regardless of its length. Under adverse weather conditions, the operator makes the stop manually, initiating deceleration at a point marked by a yellow pole on the wayside.

Where both station and train doors are used, it is necessary to align the train with the doors within an accuracy of a few inches. Both Sea-Tac and AIRTRANS have such a system. Information on train weight, instantaneous position, speed, and deceleration may be processed by an onboard computer to achieve precision stopping. At BART, a long wayside antenna provides the position signals necessary for the onboard program stop computer. Other needed information is derived and processed on board.

Door Control and Starting

Some engineers do not consider door control and starting to be train protection functions since the opening and closing of doors present no hazards to the train. Clearly, however, the safety of passengers is affected by door operation, so it is common to interlock door functions with train protection, a practice that leads some engineers to regard door control as a part of train protection.

Three basic pieces of information are required for the control of door opening. It is necessary to determine that the train is in a proper location for doors to be opened. If there are doors on both sides of the train, the proper side must be identified at each station. Assurance that the train is stopped and will not move is required. (Clearly some of these requirements must be overridden in emergency situations.)

On starting, four conditions should exist before a train leaves a station. The doors should be closed and locked. No passengers should be caught in the doors. It should be time for the train to depart. The train protection system should indicate that it is safe to move the train.

In manual systems, most of the door control, monitoring, and starting functions are performed by humans. When a conductor is on board, control and monitoring of doors is ordinarily his most important assignment. Lights are usually provided to indicate the status of all doors. (It is worth noting that a 10-car train may have as many as 40 doors, each with two leaves, on each side of the train. Thus, 160 door leaves must be monitored during the movement of

the train through the system.) Because there is no truly foolproof practical door, all U.S. rail rapid transit systems have onboard personnel to act as a back-up to insure that door closure is not initiated when passengers are boarding and leaving and to verify that no one is caught when the doors are closed and locked.

Where trains are unmanned, a more complex form of door control is required. In special environments such as the Sea-Tac and AIRTRANS systems, door systems much like those of elevators have been used. The platforms are enclosed and doors on both train and platform must be closed and locked before the train can move. Doors with pressure-sensitive edges are used to prevent possible entrapment of passengers in a closing door. All door functions are interlocked with the train protection system.

Jerk Limiting

Jerk is defined as the rate of change of acceleration. Control of jerk contributes to a smooth ride and from a rider standpoint, a somewhat safer one. Customarily, jerk limiting is a function of the propulsion not the train control system.

Jerk limiting applied during stopping is sometimes termed "flare-out control." It is identical to the maneuver that a skilled automobile driver performs just as the car is coming to a stop. By easing off on the brake, the transition from deceleration to full stop is smoothed out. Because there are safety implications to releasing the brakes, flare-out control is usually designated to be either a part of the train protection system or to be interlocked with it.

In a manually operated transit system the flare-out function is performed by the operator much as it is performed by an automobile driver. The smoothness with which the function is performed depends to a great extent upon the skill of the operator. In an automatic train control system, the flare-out function can be performed automatically by sensing the speed of the time when the train velocity becomes less than some predetermined amount. It is necessary that this reduction in braking effort be allowed to persist only for a short period of time. Otherwise, the braking system of the train could be disabled. Accordingly, flare-out is controlled by a timer so that the reduction of braking effort can persist only for a few seconds. During normal operation these few seconds are sufficient to bring the train to a complete halt, and the brakes then are re-applied. It

is essential that the design and the implementation of the flare-out system be such that a failure cannot permanently withhold braking action. Figure A-3 is a schematic diagram of a typical automatic flare-out control system.

Slip-Slide

Slip refers to the slipping of wheels during the application of power. Slide is concerned with wheels sliding when brakes are applied. Slip or slide occurs when the tractive effort of the train exceeds the adhesion capability of the wheels and rails. Excessive slip, which occurs during acceleration, can damage the propulsion equipment, wheels, and rails. Slide, which occurs during deceleration, can damage the wheels and rails; a wheel locked during braking can be ground flat on the bottom if it is dragged very far, with possible damage to the crown of the rail as well. In addition, one or more sliding wheels during braking can increase the distance needed to stop a train because the coefficient of friction between a sliding wheel and rail is lower than that between a rolling wheel and rail.

Slip-slide control is traditionally considered part of the propulsion and braking system, but it has important relationships with the train control system. For example, correction of sliding during braking can be obtained only by reducing the braking effort, which has obvious safety implications. Either through the design of the braking system or in conjunction with the train protection system, assurances must be provided that operation (or malfunction) of the slip-slide control does not permanently prevent application of the brakes when a brake application is required.

TRAIN SUPERVISION

In general terms, train operation functions are concerned with the movement of individual trains. Train protection acts as a restraint to prevent accidents for individual trains or between trains. By nature, these two groups of train control functions are tactical and localized, in that they deal with short-range concerns for specific elements or places in the transit system. In contrast, train supervision comprises a group of functions concerned with the overall regulation of traffic and the operation of the transit system as a whole. Thus, train supervision functions are strategic, systemwide, and more long-range.

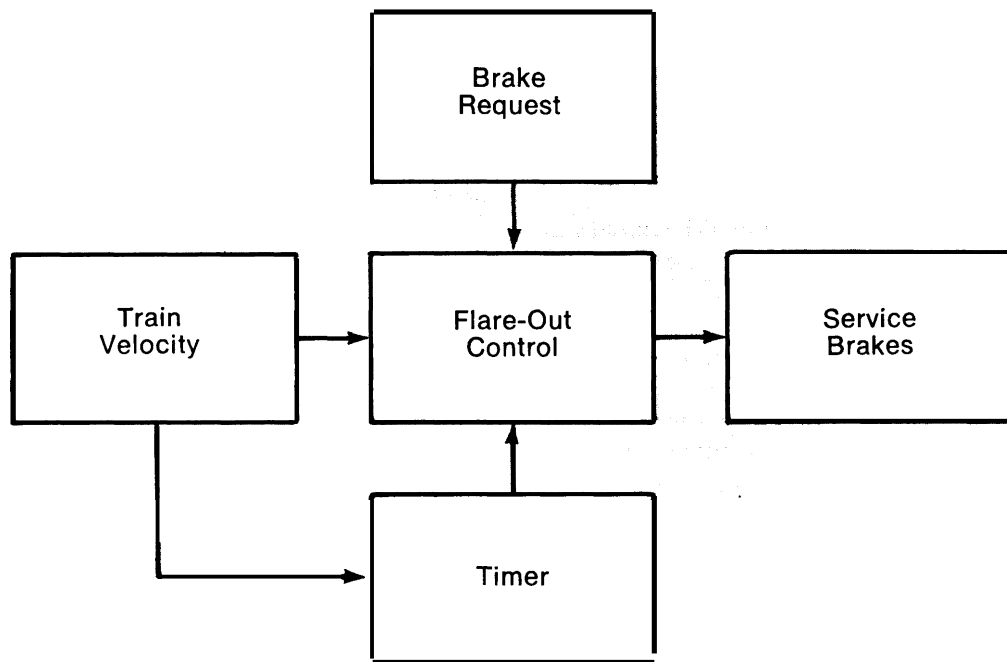

FIGURE A-3.-Conceptual Diagram of Service Brake Flare-Out Control

The functions of train supervision are:

- Schedule Design and Implementation
- Route Assignment and Control
- Dispatching
- Performance Monitoring
- Performance Modification
- Alarms and Malfunction Recording
- Recordkeeping

Schedule Design and Implementation

In most rail rapid transit systems, the functions of schedule design and implementation are not connected on a real-time basis. Train schedules are evolved to meet the transit system's objectives, whether they be minimization of operating cost, maximization of service, utilization of equipment, or whatever. Most train scheduling in such situations is performed manually, with perhaps occasional assistance from a computer,

Train schedules do not change frequently. Once a basic service pattern has been established, it may remain unchanged for months or years. The primary changes may be the addition of special trains to provide extra service to special events. This type of extra service is usually provided in off peak hours and presents no major train control problem. Providing special crews is likely to be the most difficult problem here.

Where major changes of schedule or operational procedure are contemplated, it may be necessary to utilize computer simulations. NYCTA has been using such simulations for about a decade for examining complex scheduling and routing problems. Simulations may also be used in the planning of systems. Where systems are computer controlled, provision may be made to use the computer for simulations of possible operational changes.

Operational implementation of the schedule is generally focused in some central control facility. This facility may be simple or elaborate. Hierarchical control structures may be utilized, The primary

functions of the control center are (1) receipt and display of information on the status of the system, (2) decisionmaking regarding action to be taken, and (3) issuing commands for action. It should be kept in mind that supervisory functions and decisions may affect the safety of passengers, but train supervision cannot override train protection considerations.

Most control centers have functions beyond train control alone. It is common to monitor and control the electric power systems and other critical elements such as pumps and blowers in these facilities. Monitoring of station platforms, fare collection areas, or parking lots may also be carried out by central control facility. Passenger service communications may be provided, as well as some service to the news media or the general public.

Route Assignment and Control

The supervisory system selects, assigns, and controls the routes to be followed by trains. Under normal circumstances, the routes of a conventional transit system are fixed. Major delays must be involved before train rerouting is done. In a linear two-track system, the most ordinary form of rerouting is concerned with operating the system over only one track until a problem on the other track is cleared. Except for the systems which use computers, alternating the direction of traffic flow is accomplished under the control of humans at a control center or tower. BART provides special computer programs which can generate the necessary commands for single-track operation. WMATA plans a similar approach. This approach presumably can lead to more efficient operation, both in terms of increased flow through the system and in the freeing of the controllers to make other decisions during such emergencies.

In a few transit systems, there are opportunities to route conventional trains from one line to another in case of major service disruptions. NYCTA, for example, can reroute trains on some of the main Manhattan lines. Additionally, the four-track (two local, two express) arrangement of portions of the system permits interchange of trains between some tracks on the same route—always at a loss in overall performance.

Dispatching

Train dispatching is concerned with the makeup of train sets and the timing of their departure from

selected points in the system. In conventional rail transit systems, a written schedule is used to indicate the anticipated system needs for the day, both by train size and time of departure. Dispatching usually takes place from terminals or yards.

Most train dispatching in conventional systems is accomplished through the use of preprogrammed dispatch machines at terminals and entry points. These machines simply provide a visual indication that it is time for the train to depart. In a short system such as PATCO, there is normally no further supervisory control of the motion of the train through the system. Operators are provided with a timetable, and verbal communications are used if any problem arises.

Modification of the dispatching routine may be accomplished under computer control in systems such as BART and WMATA. Manual or verbal override is used at all operating transit properties except BART. Modification of dispatching schedules is required to compensate for various delays on the line.

Performance Monitoring

Train performance monitoring is closely allied with train dispatching and route assignment. Essentially, the purpose of this function is to smooth out irregularities in the flow of traffic. Methods of performing this function range from the very simple to the very sophisticated.

Basically, there are two approaches to performance monitoring and control. They may be accomplished on an intermittent or a continuous basis. In all conventional systems in operation and being planned, performance monitoring is done on an intermittent basis. Train running times between stations or terminals are measured and any control actions deemed necessary are taken. There is no continuous monitoring of the performance of the train while it is running. (Verbal communications can ordinarily be used to provide an indication of serious performance problems as soon as they occur.)

If it is desirable to modify the performance (speed, running time, acceleration) of a train, commands for the performance modification are usually transmitted at selected wayside locations (typically stations). Continuous performance modification commands are not provided. Again, verbal com-

munications may be used to transmit a command at any time.

Performance Modification

There are two basic ways of modifying train performance. Trains may be held at specific stations to provide more uniform spacing. Either in conjunction with this or as an alternative, the actual running time of the train speed or acceleration rate can be changed.

In the systems which have the least amount of automation, performance monitoring and control is essentially accomplished by humans. Supervisory and onboard personnel monitor the state of the system. Information on significant perturbations may come in through model board displays or voice communications. Required performance modifications may be indicated by voice transmission or reductions in speed commands.

One step upward in automation is the addition of dispatching lights at certain stations. By use of such lights, trains can be held in these stations to attempt to smooth out the flow of traffic.

At the highest levels of automation are the systems which use computers to adjust performance requirements continually so as to provide schedule adherence and/or uniform flow of trains through the system. Both BART and WMATA have facilities to monitor the performance of all trains in the system and to compare the actual and desired status of the system. Through rather elaborate control procedures, computers then issue commands to modify individual train performance in a way such that the system objectives are met.

Views vary on the value of automating the function of train performance modification. At BART and WMATA not only are the desired performance levels calculated automatically, they are transmitted and implemented automatically as well. Baltimore is considering an evolutionary system which could eventually incorporate a computer. Initial thoughts are that performance level commands would be displayed in stations and onboard operators would set switches to establish performance levels for the ATO equipment. NYCTA, which plans eventual conversion to automatic train operation, does not now contemplate the use of performance level controls as such. It is planned to control train spacing by dispatching at terminals and selected stations as well as by verbal control.

Alarms and Malfunction Recording

Aside from the annunciation of delays in train motion, supervisory systems can be used to indicate other problems in carborne equipment. Fire, low air pressure, lights out, air-conditioner failure, motor failure, and many other things are potential candidates for malfunction alarm. In traditional manned systems, information on the status of onboard equipment is not transmitted to the wayside automatically. Annunciation of malfunctions is provided by displays in the operator's cab. The information may be relayed immediately by voice transmission if the problem is serious. Minor problems may be reported at the end of a run or the end of the day.

In unmanned systems, there is a greater need for annunciation of malfunctions. Both the Sea-Tac and AIRTRANS systems have malfunction annunciation systems with displays in the central control facility. A hierarchy of malfunction conditions is defined, and each group is treated in accordance with the seriousness of the event involved.

It should be noted that the annunciation system for train supervision may be a subset of a larger system which deals with the status of many types of equipment throughout the system. This may include pumps, blowers, electrical power distribution equipment, and so forth.

Recordkeeping

Supervisory equipment or personnel keep records for individual vehicles and the overall transit system. By means of train and car identification equipment, information is provided on the accumulation of car miles and used to schedule maintenance activity. If computational capabilities are a part of the supervisory system, additional functions may be performed. The computer may be used to generate work orders or schedules for routine maintenance. Spare parts ordering may be handled. Manpower utilization and payroll data may be processed. Reliability and maintainability data may be derived. Special management reports also may be generated.

Where malfunction communication equipment is used, it speeds diagnosis of system faults. In general, it appears that in-service diagnosis and repair of individual failures is significantly less important than maintaining operation of the system as a whole. Where practical, attempts are made to con-

tinue to operate trains with failed equipment long enough to get them out of service. If this is not possible, pushing a train or modular replacement of elements is attempted. The use of significant amounts of diagnostic equipment appears more appropriate in maintenance shops than on in-service equipment.

COMMUNICATIONS

Communication functions are implicit in all other types of train control system activity, and various forms of communications (both verbal and data) have been mentioned in connection with the description of train protection, operation, and supervision functions. Table A-1 is a summary of the major types of communication performed by and within the train control system. Each is discussed below, with emphasis on those that have not been treated previously.

Train Protection

Train protection communications are traditionally separate from all others. Special precautions are taken to insure that signals from other circuits or systems do not mix with train protection signals.

It appears that future ATP systems will all rely heavily on electrical or electronic transmission systems. Voice communications are a part of ATP but, in general, play a minor role. Voice communications are largely used to transmit information regarding visual verification of a safety situation or procedural instructions related to emergency operation.

Operational Control and System Status

These two functions are discussed together because system status provides the feedback information for operational control. Essentially, these are the communications involved in the train supervision function. Most routine status information is transmitted by electrical means and displayed visually. In automated systems, much of the status information is processed directly by computers. Visual displays may be provided routinely or on a call-up basis.

Status information includes more than just the motion of vehicles. It also concerns conditions on platforms, availability of trains in yards, track conditions, and any of a hundred other things. Malfunction alarms transmitted from carborne or wayside equipment provide status information on certain equipment. The more highly automated the system, the greater the need for equipment status information, but this does not necessarily mean increased automation of the means for transmitting equipment status information. If additional information is to be communicated, it can also be given over a voice channel by the onboard attendant.

Operational commands may be transmitted by almost any means, ranging from a printed timetable to electronic devices. There is a trend toward use of electrical or electronic devices for signal transmission in the new systems being planned, but there are some specific exceptions. NYCTA, for example, plans to operate a hierarchical supervisory system in which major decisions will be made in a command center and relayed by voice or teletypewriter to dispersed towers for execution, Baltimore is considering visual transmission of performance level

TABLE A-1.—Primary Means of Communicating Information Related to Train Control

Function	Primary Means of Transmission (T) and Display (D)			
	Visual	Voice	Electric Signal	Written
Train Protection	T, D	—	T, D	—
Operational Control	D	T	T, D	—
System Status	D	T	T, D	—
Emergency Communication	—	T	—	—
Passenger Service	—	T	—	—
Maintenance Information	—	T	T	T, D
Business Operations	—	—	T	T, D

adjustments using displays on the wayside in stations. Voice communication with all trains appears to be an essential element in all new systems and in upgrading old ones. Emergency operational commands may thus be relayed by voice communication.

Emergency Communications

Emergency communications are the only type that may involve contact with outside agencies or employees not on trains or reachable by telephone. For this and other reasons, at least one space radio system is provided in all transit systems to allow communication with roving employees.

It is felt by most transit system managers that the ability to communicate with passengers, preferably two-way but at least one-way, is extremely important in controlling emergency situations. Assuring the passenger that his plight is known and help is on the way is believed to have considerable psychological value.

Emergency communications may also involve dealing with police and fire departments as well as other organizations of the civil government. These communications may be handled either by radio or telephone.

The human role in emergency communications is very important for the simple reason that the nature of emergencies is such that unexpected events occur. Because humans respond to a very wide range of situations, it seems unlikely that the emergency communication role of the human can be replaced.

Passenger Service

Train control equipment or personnel act to provide information to the passengers. In most systems, onboard operators or station personnel provide information on station identity and train destination. ATS equipment is used to perform some of these functions in highly automated

systems. At BART, for example, special destination signs indicate the imminent arrival of trains, the approximate location at which the trains will stop, and the destination of the trains. These particular signs are also used to display commercial messages and thereby produce revenue for the system. Both AIRTRANS and Sea-Tac utilize prerecorded messages in the trains to provide information to passengers. AIRTRANS has both TV displays and lighted signs to display route information at the stations.

Maintenance Information

Elements of the train control system maybe used to provide information needed for scheduled or unscheduled maintenance. Train and car identification systems can be used to provide information on accumulated car miles. In highly automated systems, malfunction detectors and annunciators transmit malfunction information either directly to the maintenance facility or through central control to the maintenance facility. Voice communications relating to maintenance problems may be channeled through central control or handled directly.

Communication of maintenance information related to inventory control may also be handled over the ATC communication system, especially if a central computer is used. This maybe accomplished over commercial telephone lines, or special data transmission links. Except for fully automated systems, there does not appear to be a trend toward significant increases in ATC communications for maintenance information transmission.

Business Operations

Basic data available from the train control system may be used in planning business operations regarding workforce allocation, expansion plans, procurement policies, vehicle utilization, and so on. This information is generally presented in the form of tabulated reports which may be computer print-outs or periodic manual summaries of system performance parameters.

AUTOMATIC TRAIN CONTROL TECHNOLOGY⁹⁷

The technology of automatic train control embraces many kinds of equipment and engineering techniques. All aspects of this technology cannot be adequately presented in a brief appendix such as this. Therefore, the discussion is confined to two major elements of train control technology: the track circuit and methods for speed command and control. The technology forms the basis for almost all automation of train protection, train operation, and train supervision functions. Of the two, the track circuit is the more basic. It was the first to be developed, and it underlies the operation of speed command and control systems. It is the fundamental method of train detection and, while there has been experimentation with other methods over the years, none has proven to be as effective and reliable as this electrical technique for determining the presence and location of transit vehicles. From this basic positional information, signal systems are operated, train protection is accomplished, train operation is controlled, and supervisory functions are carried out.

TRACK CIRCUITS

The track circuit is an electrical circuit which includes a length of running rails (or special rails) and permits detection of the presence of a train. A track circuit may also be used to communicate commands, instructions, or indications between the wayside and a train. Track circuits provide information on the location of the trains, and this information is used to command train speeds so that the trains operate safely. For instance, if a train attempts to approach too close to the rear of another train, information on the locations of the two trains, provided by the track circuits, is used to command a

slowdown or stop of the following train before there is danger of a rear-end collision.

The basic d.c. track circuit was invented by Dr. William Robinson and first used in a railway application is 1872. Although the equipment and technology have changed considerably in their detail since that time, the basic principle has remained the same. An electrical signal of some kind is impressed between the two running rails, and the presence of a train is detected by the electrical connection between the two running rails provided by the wheels and axles of the train (wheel-to-rail shunting).⁹⁸

Before proceeding to a discussion of the various types of track circuits, it must first be considered how track circuits are used in the operation of a transit system. A track circuit provides information on whether a train occupies a given length of track (a block). The occupancy information for a particular block and for contiguous upstream of blocks is used to control the operation of all trains within the given area. For instance, when a train is detected in a block, that occupancy information is used to cause a zero-speed command for the block immediately behind the train. Depending upon the block lengths, the line speeds involved, and the number of available speed commands, the second block behind the train may have a command speed between zero and full line speed. The third block behind the train may have a commanded speed greater than or equal to the second block, and so on. In all cases, the blocks behind a train are signaled so that a train entering a block has sufficient braking distance to leave the block at a speed not greater than the commanded speed. In the case of a zero-speed command, the

⁹⁷This appendix is based on material originally prepared by Battelle Columbus Laboratories in support of the OTA study. The editors gratefully acknowledge the contribution of Battelle Columbus Laboratories but accept full responsibility for the version presented here and for any alteration of content that may have been introduced in condensing and editing the material for publication.

⁹⁸In transit systems with rubber-tired vehicles, special rails are mounted beside the guideway and brushes or shoes on the vehicle contact these rails as the vehicle moves along. The special rails replace the running rails of a conventional steel-wheel, steel-rail system, and the brushes or shoes replace the wheels and axles of a train in the operation of the track circuits. This is only a difference in detail; the principle is the same as in conventional track circuits.

train must be able to stop before it comes to the end of the block.

D.C. Track Circuits

In all track circuits an electrical signal of some kind is impressed between the running rails, and the presence of a train is detected by the electrical connection that the wheels and axles of the train make between the two running rails. In d.c. track circuits, the electrical signal is direct current, usually supplied by batteries. The detector for the electrical signal is a relay.

Figure B-1 shows a simple d.c. track circuit. The track circuit consists of a block or length of track which is defined at each end by insulated joints in the running rails. The insulated joints provide electrical insulation between a given track circuit and the abutting tracks which comprise other track circuits. The signal source, in this case a battery, is connected to the rails at one end of the track circuit while the receiver (a relay) is connected to the other end. When no train is present, the track circuit is said to be unoccupied, and the direct current supplied by the battery is transmitted by the running rails to the relay and energizes it or "picks it up." When the relay is energized, the upper set of relay contacts is connected causing the green signal light to be turned on. When a train enters the track circuit its wheels and axles connect the two running rails together, shorting the battery and thereby reducing the current through the relay. This causes the relay to "drop," as shown by the dashed line in the diagram. This action connects the bottom set of relay contacts, turning off the green signal light and

turning on the red light to indicate that the block is occupied by a train. The resistor in series with the battery protects the battery by limiting the current the battery must provide when a train is present,

The terms "pick up" and "drop" refer to the position of the special "fail-safe" relays used for train detection. These relays are constructed from specifications approved by the Association of American Railroads and are designed so that their normally open "front" contacts will be closed only when sufficient electrical energy is being supplied to the coil. One or both of the normally open contact members are made of carbon or carbon impregnated with silver, which cannot be welded. The relays use gravity rather than spring return and are mounted vertically so that the relay armature, to which the contacts are attached, is returned to the dropped position when the current through the coil is reduced below some critical value. The failure rate of these relays for the mode in which the normally open contacts would be closed with no power applied to the relay coil is so low that for all practical purposes it is considered to be zero.

The track circuit shown here has been simplified for the purpose of illustration. In actual practice, the relay would have several sets of contacts connected in combination with the contacts from other relays in nearby track circuits to form logic circuits for the control of the signaling devices (the red and green lights). Even in the simple form shown in Figure B-1, however, it can be seen that the breaking of any conductor or the loss of power in the circuit will cause either a red signal or no signal at all to be displayed. A red or "dark" signal is always to be in-

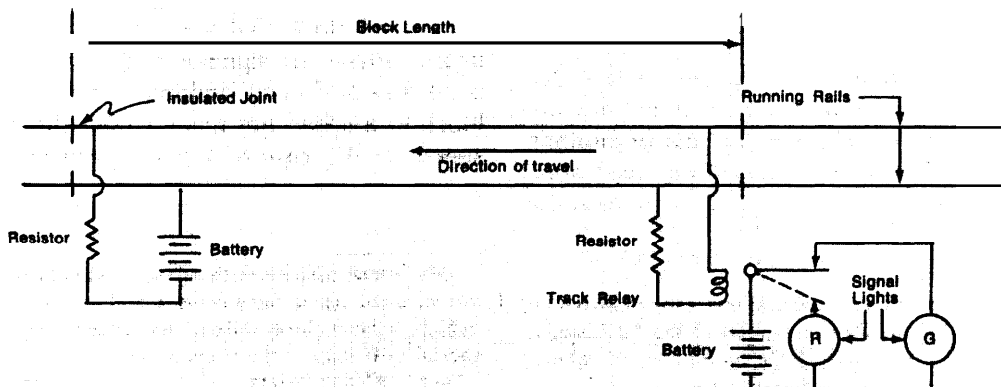

FIGURE B-1.—Simple D.C. Track Circuit

terpreted as a command to stop. If, for instance, the green light burned out or the relay coil open-circuited so that the relay could not be “picked up,” it would be impossible to have a “green” signal. In that case a train would be required to stop when it arrived at that signal. To put it another way, all signaling systems are designed so that a green signal (meaning proceed) is presented only when the track circuits provide positive information that it is safe to do so.

The double-rail d.c. track circuit is susceptible to interference when the running rails are also used as the return for d.c. electric propulsion current. For this reason, d.c. circuits are not used in rail rapid transit.⁹⁹ Single-rail d.c. track circuits could be used, but in fact all modern rail rapid transit systems use some form of a.c. track circuit.

Power-Frequency A.C. Track Circuits

The power-frequency a.c. track circuit is energized by an alternating electrical current with a frequency in the range of 50 to 150 hertz.¹⁰⁰ Except for the type of current and apparatus used, the a.c. track circuit is similar in operation to the d.c. track circuit described above.

⁹⁹The principal modern application of the double-rail d.c. track circuit is in railroads with diesel-powered locomotives.

¹⁰⁰This type of circuit is often called simply an a.c. track circuit.

Figure B-2 shows a simple power-frequency a.c. track circuit. As with the d.c. circuit, the a.c. track circuit consists of a block or length of track which is defined at each end by insulated joints in one or both of the running rails. Figure B-2 shows a double rail circuit with insulating joints in both rails. The a.c. signal source (usually a transformer) is connected to the rails at one end of the track circuit while the receiver (a relay) is connected to the other end. In addition to the signal source and the receiver, the a.c. track circuit contains a pair of impedance bonds at each pair of insulated joints. An impedance bond is a center-tapped inductance which is connected across the rails on both sides of the insulated joints. The center taps of the pair of impedance bonds are connected together as shown. The purpose of the impedance bonds is to provide continuity between the track circuits for the d.c. propulsion power and to distribute the propulsion current between the two running rails. The impedance bonds do this while still maintaining a relatively high impedance at the signaling frequencies between the two rails and between adjacent track circuits.

When no train is present, the alternating current supplied by the transformer at the left side of the diagram in Figure B-2 is transmitted by the running rails to the relay and “picks it up.” The energized relay turns on the green signal light, exactly as in a d.c. track circuit. The wheels and axles of a train en-

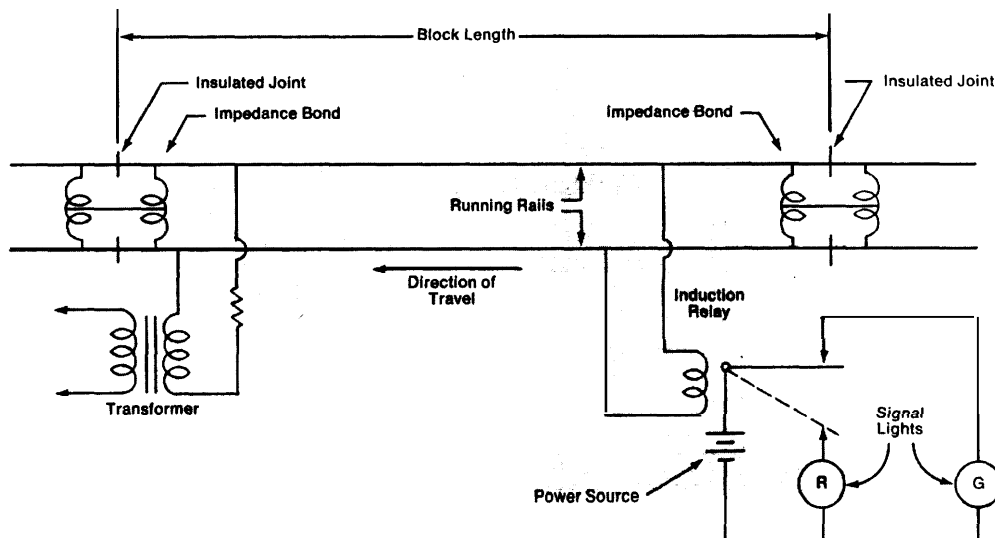

FIGURE B-2.—Simple Power-Frequency A.C. Track Circuit

tering the track circuit connect the two running rails together; and the current through the relay is reduced, causing the relay to “drop.” This connects the bottom set or relay contacts, turning off the green light and turning on the red light to show that the block is occupied. The resistor in series with the transformer (at the left in the diagram) protects the transformer by limiting the current that the transformer must provide when a train is present.

High-Frequency A.C. Track Circuits

Some a.c. track circuits use a current that alternates at a frequency in the range of hundreds or thousands of hertz. Because this frequency range corresponds roughly to the spectrum of audible sound, such circuits are sometimes called audiofrequency track circuits.

High-frequency a.c. track circuits eliminate the need for insulated joints in the running rails. Because insulated joints are expensive to install and to maintain, eliminating them leads to a significant cost reduction. Eliminating insulated joints also allows the track circuit to operate with the continuous welded rails being used in some newer installations.

Figure B-3 shows a simple high-frequency a.c. track circuit. Since no insulated joints are used in the running rails, the ends of the block established by special transformers are connected to the rails.

The transformer winding attached to the rails is usually a single turn of heavy copper bar stock. The transformer core is often a toroid. The other transformer winding is tuned to resonate at the operating frequency by a capacitor. The transmitter is the a.c. signal source and provides electrical energy at the operating frequency in the audiofrequency range. The receiver in this case is not simply a relay, as with the d.c. and power-frequency a.c. track circuits, but an electronic circuit which responds to the electrical signal provided by the transmitter. The receiver may be used to actuate a relay which performs functions like those in the d.c. or power-frequency a.c. track circuits. Thus, when no train is present the high-frequency a.c. potential supplied by the transmitter is connected to the running rails by the transformer and transmitted along the running rails to the other transformer and its associated receiver. When the receiver detects the high-frequency a.c. signal, the relay is energized and the green signal light is turned on. When a train enters the block, the circuit behaves much as it would with the a.c. or power-frequency a.c. track circuits. That is, the train wheels and axles connect the two running rails together, and the current to the receiving transformer and its associated receiver causes the track circuit relay to drop, turning off the green light and turning on the red light.

The circuit illustrated in Figure B-3 is highly simplified. In practice, it is necessary to accommo-

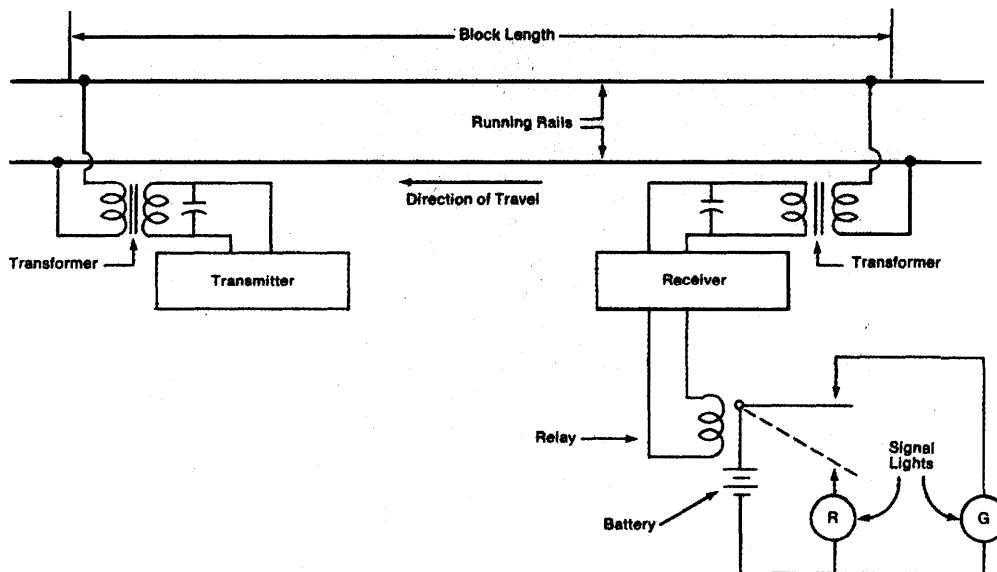

FIGURE B-3.—Simple High-Frequency A.C. Track Circuit

date the adjacent track circuits on either side. Rather than install two separate transformers for each track circuit, a second resonant winding can be included in each transformer or a heavy primary winding can be passed through more than one transformer core. Thus, a single transformer assembly is used at the boundary between adjacent track circuits and serves each. Although part of the same transformer assembly, the resonant windings are effectively isolated from each other because they are tuned to and operate on different frequencies.

Figure B-4 shows another type of high-frequency a.c. track circuit. No insulated joints are used in the running rails. The ends of the block or track circuit are established by shunts which are heavy copper cables or bars attached to the rails. The transmitter is the a.c. signal source and supplies electrical energy to a loop which is placed between the rails as shown. The loop is the primary of a transformer of which the rails and the shunts form the secondary. At the other end of the track circuit, a pickup directs the high-frequency a.c. energy to the receiver, which in turn actuates the track circuit relay. When no train is in the track circuit, the high-frequency a.c. potential supplied by the transmitter is directed into the loop and thence into the running rails to the pickup associated with the track shunt shown at the right portion of the diagram. When the receiver detects the high-frequency a.c. signal, the

relay is energized and the green light is turned on. When a train enters the track circuit, the wheels and axles connect the two running rails together, and the current to the receiver is reduced. The reduced current to the receiver causes the track circuit relay to drop, turning off the green light and turning on the red light, as in other types of track circuits. The relay in a practical circuit would have several sets of contacts which would be connected in combination with the contacts from relays in nearby track circuits to form logic circuits for the control of the signaling devices.

In practice a transmitting loop and a pickup are associated with each track shunt. Adjacent track circuits are operated on different frequencies, and the receivers have frequency selectivity so they only respond to their intended frequencies. This is the type of track circuit used in the BART system.

Check-In/Check-Out Circuits

All of the track circuits described up to this point operate on the closed-circuit principle. Any disruption of the circuit by a train passing along the rails or by power or component failure, "opens" the circuit and causes a red (stop) indication to be displayed by the signal system.

An alternate approach to track circuit design uses "check-in/check-out" logic. Simply stated, this cir-

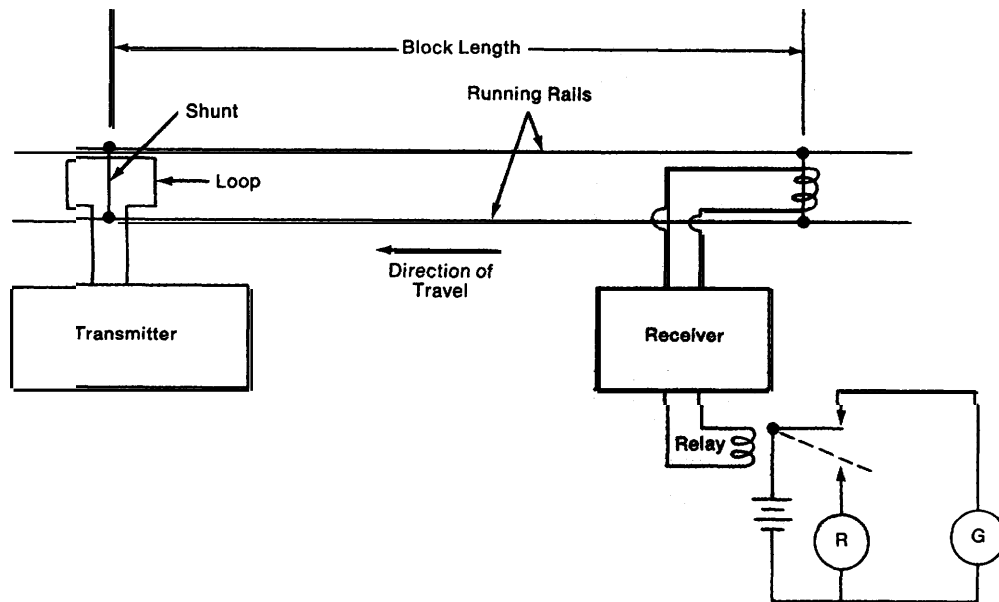

FIGURE B-4.—Alternate High-Frequency A.C. Track Circuit

cuit is based on the principle that once a train is detected or "checked in" to a block, it is assumed to be there until it is "checked out" by being detected in an adjacent block. The presence of a train may be detected only intermittently at the time when it enters a new block. This is in contrast to the conventional track circuits described above in which the presence of a train is detected continuously. In some check-in/check-out systems the first and the last cars of a train are checked in and out of the blocks as the train moves through the system, A transmitter of some kind located on the train can be used with a receiver at a fixed wayside location to indicate that a train has entered the block associated with the wayside receiver, In some cases, two transmitters are used, one at the head end of a train and the other at the rear. When the head-end transmitter enters a new block and is checked in, the block remains in the occupied condition until the rear-end transmitter also indicates that the rear end of the train has entered the new block, At that time, the train is checked out of the block behind.

Check-in/check-out has some operational disadvantages, For instance, consider the effects of a temporary loss of power to the signal system. With conventional track circuits, the loss of signal power will cause all track circuits to indicate occupancy, but when the signal power is restored, the true occupancy situation is again indicated. With a check-in/check-out system, the loss of signal power may destroy the "memory" circuits charged with "remembering" that a train has entered a block. The memory often consists of electrical relays which are energized (or deenergized) to indicate the presence of a train in a block. The loss of electrical power can destroy the information stored in such a memory. (A memory whose information can be lost by a loss of electrical power is termed "volatile.") Thus, when the signal power is restored, the information on track circuits which are occupied may have been lost. In this case the identity and location of each train in the affected portion of the system must be established before the entire transit system can be operated again safely. In a small transit system the identification and location of each train may not be difficult to establish. However, in a large, complex system even a short-term interruption of a portion of the system can create a bottleneck which makes it very difficult to restore the system to full operation. Thus, check-in/check-out systems do not find application as the primary train detection system in rail rapid transit systems.

A special case of a check-in/check-out system is the SOR (sequential occupancy release) system recently installed at BART, which uses the check-in/check-out principle as a logical back-up to the primary train detection system which uses high-frequency a.c. track circuits. The purpose of SOR is to protect against the loss of train detection in the event the primary system fails and to prevent service interruptions due to false occupancy indications,

The SOR system provides a latch such that an occupied track circuit continues to indicate occupancy until it is reset by the detected occupancy of the second downstream track circuit. Thus, with the loss of shunt or failure to detect the presence of a train, the latched-up track circuit still indicates occupancy and prevents a following train from colliding with the rear of the leading train. A series of computers is used in the SOR system, and the logic is such that the computers can recognize false occupancies, i.e., a track circuit which shows occupancy without a prior occupancy of the preceding track circuit is considered by the computer to be falsely occupied,

SPEED COMMAND AND CONTROL

In considering how the speed of transit vehicles is controlled by automatic devices, it is important to understand the principle of closed-loop control before proceeding to a discussion of the means by which speed commands are transmitted and received, A closed-loop control system is one in which some feedback of information on the status of the system (or its response to command inputs) is used to modify the control of the system. As a minimum, feedback verifies that the command was received, Feedback may also be used to modulate subsequent command inputs so as to smooth out irregularities of response, to make increasingly more precise adjustments of the state of the system, or to compensate for external perturbations. Thus, the basic purpose of closed-loop control is to assure continuity of control by confirming that command inputs have been received and that the commanded state of the system has, in fact, been achieved.

The alternative to closed-loop control is open-loop control, where commands are transmitted from the controlling to the controlled element without any feedback or acknowledgment that the command signal has been received and interpreted properly. The traditional wayside signaling of rail rapid

transit is an open-loop system. So, too, is a manually operated train with cab signals, although the automatic overspeed and stop enforcing mechanisms of cab signals represent the beginning of a closed-loop system. Systems with ATO are true closed-loop systems. Feedback is used to monitor the response to propulsion and braking commands and to regulate the performance of the system on a continuous, real-time basis. Thus, a closed-loop system, in contrast to an open-loop system, is characterized by continuous control and self-adjusting commands conditioned by observation of system response.

The technology for controlling the speed of transit vehicles is based on the track circuit. The signals used for train detection can also be used for the transmission of speed commands to wayside signaling devices and to the trains. Two general methods are used for the transmission of such commands. In one method, the track circuit signal is turned on and off at a specific rate, which is interpreted as a speed command. This rate modulation scheme is called a coded track circuit. The second method is called binary message coding. With either method, equipment on the wayside or on the train senses the signals in the rails and decodes the speed command.

Coded Track Circuits

This technique is applicable to either d.c. or a.c. track circuits. The track circuit signal is switched on and off (modulated) at a rate which is related to the speed command. The switching rates are in the range from about 50 to 500 times per minute. In a d.c. track circuit, the direct current applied to the running rails at one end of the track circuit is simply turned on and off at the desired rate. Wayside equipment at the other end of the track circuit receives and decodes the signals. A code-following track relay is used in the track circuit and codes continuously when the circuit is not occupied. The relay is energized when the current is allowed to flow and is deenergized or "drops" when the current stops. The decoding equipment is actuated by the contacts of the code-following relay. When a given code (rate of transmission) is received, a particular relay in the decoding equipment is energized and remains energized as long as that code is being received. The relay, in turn, controls the appropriate wayside signal. When another code is received, another relay is energized as long as that code is being received. When a train enters the track cir-

cuit, the code-following relay is deenergized, and this fact is used to indicate the presence of a train. Typical interruption rates for these circuits are 75, 120, and 180 times per minute.

In a.c. track circuits, either power-frequency or audiofrequency, the a.c. signal is turned on and off at a selected rate. Since the switching rates for the coded signals are so much slower (1-3 per second) than the frequencies of the a.c. signals applied to the track circuit (50-150 per second), many cycles of the a.c. signal occur during the time that the code signal is switched on. The coded track signal can be received by wayside equipment at the far end of the track circuit and used to control wayside signals or it can be received on board a train and used to control the speed of the train. The presence of a train stops the operation of the code-following relay and indicates occupancy of the track circuit. The coded track signals are received on board a train by a pair of coils mounted near the front of the leading car just a few inches above each of the two running rails and in front of the first set of wheels and axle. The magnetic field from the electric current carried in the rails produces a signal in these coils (sometimes called antennas), and this signal is processed or decoded to determine the switching rate and hence the speed command. The decoded speed command is used in an automatic system to control the speed of the train. In a semiautomatic system, the decoded speed command is displayed to the train operator who then regulates train speed manually.

Binary Coded Track Circuits

This technique is sometimes used with audio-frequency a.c. track circuits. It could also be used with power-frequency a.c. circuits, but customarily it is not. Instead of turning the track circuit signal on and off (rate modulation), the frequency of the track signal is changed from one to the other of two discrete frequencies. This technique is particularly adaptable to digital systems in which one frequency corresponds to the transmission of a "1" and the other frequency corresponds to the transmission of a "0." The track circuit receiver responds to both of the signaling frequencies that are used. When a train enters the track circuit, the amplitude of the signals at the track circuit receiver is reduced below some threshold and this information is used as an indication of the presence of the train. On board the train two antennas or coils are mounted near the

front of the lead car close to the running rails and in front of the first set of wheels and axle. As with the coded track circuits, the magnetic field from the electric current carried in the rails produces a signal in these coils, and this signal is decoded to deter-

mine the speed command. In an automatic system, the decoded speed command is used to control the train speed. In a semiautomatic system, the decoded speed code information is displayed to the train operator who controls train speed manually,

DESIGN CHARACTERISTICS OF SELECTED RAIL RAPID TRANSIT SYSTEMS

This appendix is a tabulation of the ATC design characteristics and engineering features of five operating rail rapid transit systems:

- Bay Area Rapid Transit (BART)
- Chicago Transit Authority (CTA)
- Massachusetts Bay Transportation Authority (MBTA)
- New York City Transit Authority (NYCTA)
- Port Authority Transit Corporation (PATCO)

Listed vertically at the left of the tables are the generic functions which must be accomplished to provide train protection, train operation, train supervision, and system communications.¹⁰¹ Arrayed beside these functions are descriptions of the equipment and techniques employed in the five transit systems. The major distinction is between manual and automated techniques, with supplementary material to indicate specific engineering and operational features.

None of the rail rapid transit systems described here is completely manual or completely automatic.

¹⁰¹See appendix A for a definition and description of these functions.

All represent various combinations of manual and automatic train control—the particular mixture being determined by local needs and conditions, the history of engineering development in each locale, and (for the newer systems, at least) the fundamental design philosophy. Generally speaking, NYCTA and CTA are the least automated of the five transit systems, although both have a considerable amount of automation of train protection functions. The Red Line of MBTA represents a higher level of automation, incorporating some automatic train operation features in addition to basic automatic train protection. The other MBTA lines are equivalent to NYCTA or CTA in the extent of automation, PATCO is still more automated, with virtually all train protection and operation functions assigned to machine components. On the other hand, PATCO has almost completely manual means of train supervision. BART is the most highly automated of the five systems. Train protection and operation are fully automatic, but monitored by an onboard operator. Train supervision is also largely automated, with extensive use made of central computers to accomplish functions that are performed by dispatchers and towermen in other transit systems. The order of listing in the table indicates progressive increase in the general level of train control system automation.

TRAIN CONTROL SYSTEM CHARACTERISTICS

TRAIN PROTECTION FUNCTIONS	NYCTA	CTA
Train Detection		
Monitoring of track occupancy	Conventional voltage level track circuits of two types: single rail, power frequency, hardwired double rail, power frequency, hardwired	Conventional voltage level track circuit of three types: single rail, power frequency, hardwired double rail, power frequency, hardwired double rail, audio frequency, hardwired
Train Separation		
Collision prevention, primarily by blocks to ensure safe separation and speed limits to ensure safe stopping distance	Fixed blocks (length: 40-1200 ft.) Relay logic Minimum design headway: 1 1/2 min.	Fixed blocks (length: 300-2000 ft.) Relay logic Minimum design headway: 1 1/2 min.
Movement Commands		
Speed and stopping commands to trains	Wayside signals Three-aspect block signal system (Proposed cab signal system will have 70,50, 35, 25, 15, and 3 mph speed commands and a cab signal cutout. Absence of a positive command is interpreted as 0 mph.)	Mixture of wayside and cab signals Three-aspect block signal system Five cab signal speed commands (70, 35,25, 15,0 mph)
Overspeed Protection		
Comparison of command and actual speed to ensure that civil speed limits are not violated	Wayside signals with timers and trip stops	Mixture of cab signals with automatic overspeed protection and wayside signals with timers and trip stops
Speed Determination		
Sensing and display of actual train speed	Estimated by motorman, no speedometer in cab except on new R 44 and R-46 cars.	Tachometer, with speedometer in cab
Interlocking		
Prevention of conflicting train movement through switches and along routes	Mixture of electro-mechanical and all-relay	Mixture of mechanical, electro - mechanical, electro-pneumatic, and all-relay
Train and Track Surveillance		
Monitoring the right-of-way for obstructions, persons on track, broken rails, etc.	Visual track surveillance (primarily by motorman with some assistance from conductor)	Visual track surveillance (primarily by motorman with some assistance from conductor); cab signal for broken rail protection
Monitoring condition of train systems.	Status of some carborne systems is monitored automatically and displayed by annunciator placards in the cab.	Status of some carborne systems is monitored automatically and displayed by annunciator placards in the cab.

MBTA	PATCO	BART
<p>Conventional voltage level track circuits of three types: single rail, power frequency, h a r d w i r e d double rail, power frequency, hardwired double rail, audio frequency, hardwired</p>	<p>Conventional voltage level track circuits of two types: single rail, power frequency, hardwired (yard only) double rail, power frequency, hardwired (revenue tracks)</p>	<p>Low voltage level track circuits: double rail, audio frequency, multiplex one rail; power frequency track circuits in yards</p>
<p>Fixed blocks (length: 425-2100 ft.) Relay logic Minimum design headway: 1 1/2 min.</p>	<p>Fixed blocks (length: 295-3400 ft.) Relay logic Minimum design headway: 2 min.</p>	<p>Fixed blocks (length 75-1100 ft.) Solid-state logic Minimum design headway: 1 1/2 min. (With sequential Occupancy Release system, headways are restricted to 2 min.)</p>
<p>Mixture of wayside and cab signals Three-aspect block signal system Eight cab signal speed commands (70, 65,50,40,25, 10,0 mph and yard speed)</p>	<p>Cab signals Five speed commands (75, 40,30, 20, 0 mph) to ATO system which controls speed</p>	<p>Cab signals Eight speed commands (80, 70,50, 36, 27, 18,6, 0 mph) to ATO system which controls speed</p>
<p>Mixture of cab signals with automatic overspeed protection and wayside signals with timers and trip stops</p>	<p>Cab signals with automatic overspeed protection</p>	<p>Cab signals with automatic overspeed protection</p>
<p>Estimated by motorman, no speedometer in cab except for Silverbird cars on Red Line</p>	<p>Tachometer, with speedometer in cab</p>	<p>Tachometer, with speedometer in cab</p>
<p>Mixture of electro-mechanical and all-relay</p>	<p>All-relay</p>	<p>All -relay</p>
<p>Visual surveillance (primarily by motorman with some assistance from train guards); cab signal for broken rail protection (Red Line only)</p>	<p>Visual surveillance by train operator cab signal for broken rail protection</p>	<p>Visual surveillance by train operator cab signal for broken rail protection</p>
<p>Status of some carborne systems is monitored automatically and displayed by annunciator placards in the cab.</p>	<p>Status of some carborne systems is monitored automatically and displayed by annunciator placards in the cab.</p>	<p>Status of some carborne systems is monitored automatically and displayed by annunciator lights in the cab.</p>

TRAIN CONTROL SYSTEM CHARACTERISTICS—Continued

TRAIN SUPERVISION FUNCTIONS	NYCTA	CTA
Schedule Design and Implementation		
Planning of service in light of anticipated demand, available equipment, and environmental conditions (includes orders to execute the plan)	Manual	Manual
Train Identification		
Determination of the route and destination of a train	Mixture of manual and automatic (Automatic only on R-44 and R-46 cars, where passive unit on train resonates when excited by wayside equipment)	Mixture of manual (by train operator or towerman) and automatic (passive unit on train resonates when excited by wayside equipment or optical scanning of identity panel on train by wayside equipment)
Train Dispatching		
Control of train departures from terminals (or waypoints) in accordance with schedule	Mixture of manual and automatic (electro-mechanical clock)	Mixture of manual and automatic (electro-mechanical clock)
Route Assignment and Control		
Selection and assignment of routes to be followed by trains, including periodic update reports by trains as to identity, location, and destination	Mixture of manual methods (by central control remotely or by towerman locally) and automatic control based on train identity information or track circuit occupancy	Mixture of manual control by local towerman and automatic control based on train identity information or track circuit occupancy
Performance Monitoring		
Following the progress of trains against the schedule	Visual observation (model boards in towers and central control) Also manual check-off at towers	Visual observation (model boards in towers and pen graph recorders at central control)
Performance Modification		
Adjustment of movement commands or revision of schedule in response to traffic conditions	Verbal instructions to adjust running speed or station stops; remotely controlled starting signals to delay departure from terminals and control points	Verbal instructions to adjust running speed or station stops; remotely controlled starting signals to delay departure from terminals and control points
Alarms and Malfunctions Recording		
Alerting to malfunctions and problems and recording of time, location, and nature	Manually activated electrical alarming and manual recording based on verbal reports	Manual alarming and recording based on verbal reports
Yard Train Control		
Train assembly, routing, and movement with in yards and to and from revenue tracks	Manual train operation and a mixture of manual and automated switching	Manual

MBTA	PATCO	BART
Manual	Manual	Schedule prepared manually and fed into central computer
Mixture of manual and automatic (optical scanning of identity panel on train by wayside equipment)	Automatic (passive unit on train resonates when excited by wayside equipment)	Automatic (active unit on train transmits identity to wayside transceiver for relay to terminals, stations, and central control)
Mixture of manual and automatic (electro-mechanical clock)	Automatic (electro-mechanical clock)	Automatic (computer controlled)
Mixture of manual methods (by central control remotely or by towerman locally) and automatic control based on train identity information or track circuit occupancy.	Mixture of manual control by central control remotely and automatic control based on train identity information or track circuit occupancy	Automatic (trainborne destination information transmitted to wayside equipment which automatically sets route); manual control (by central or local controllers) available as an alternative or back-up mode
Visual observation (model boards in towers and central control)	Visual observation (model board at central control)	Visual observation (model boards at central control and towers) with computer-aided display and alerting
Verbal instructions to adjust running speed or station stops; remotely controlled starting signals to delay departure from terminals and control points	Verbal instructions to adjust running speed or station stops; remotely controlled starting signals to delay departure from terminals and control points	Automatic, station dwell time and train performance mode (speed and/or acceleration) controlled by central computer (can be selected by computer automatically or by manual input)
Manual alarming and recording based on verbal reports	Manual alarming and recording based on verbal reports	Automatic alarming and recording for some events; manual inputs to computer record also possible
Manual	Manual	Manual (special hostling control panel)

TRAIN CONTROL SYSTEM CHARACTERISTICS—Continued

TRAIN OPERATION FUNCTIONS	NYCTA	CTA
Velocity Regulation		
Control of actual speed in relation to command (civil) speed	Manual	Manual
Station Stopping		
Stopping train in alignment with station platform	Manual	Manual
Door Control		
Opening and closing of doors at stations	Manual, by conductor	Manual, by conductor (or operator on single-car trains)
Train Starting		
Departure from station	Manual, by operation of propulsion control	Manual, by operation of propulsion control

COMMUNICATION SYSTEMS	NYCTA	CTA
Train – Central	Radio	Train phone
Train – Station	No direct link, relayed through central control	No direct link, relayed through central control
Train – Wayside	Radio	No direct link, relayed through central control
Central - Station	Telephone; also public address system on platform at some stations and automatic train departure signs at some terminals	Telephone; also public address system on platform at some stations and automatic train departure signs at some terminals
Central – Wayside	Radio and dial telephone	Dial telephone; also public address to certain key towers and terminal supervisors
Station – Wayside	Dial telephone	Dial telephone
Station – Station	Dial telephone	Dial telephone
Wayside - Wayside	Radio and dial telephone	Dial telephone
Outside Emergency Assistance	Walkie-talkie radio net for police, central control and key dispatchers, other assistance summoned through central control	Dial or direct-line telephone

MBTA	PATCO	BART
Automatic on Red Line, with manual operation (at full speed) available as alternative mode. Manual on other lines	Automatic, with manual operation (at, full speed) available as alternative mode.	Automatic, with manual operation (at reduced speed) available as a back-up mode or if track conditions dictate
Manual	Automatic Stop command triggered when train passes fixed wayside point; braking effort to stop in required distance reckoned from wheel revolution	Automatic Continuous stop command generated by wayside equipment; braking effort to stop in required distance reckoned from wayside measuring points.
Manual by train guard (conductor)	Manual by train guard (motorman)	Automatic, with manual override
Manual, by operation of propulsion control	Manual, by depressing start button	Automatic

MBTA	PATCO	BART
Radio No direct link, relayed through central control	Train phone No direct link, relayed through central control	Radio No direct link, relayed through central control
Radio	No direct link, relayed through central control	Radio
Telephone and public address system on station platforms; some startees equipped with walkie-talkie radios	Telephone, public address, closed-circuit TV, and call-for-aid phones at automatic fare collection gates	Telephone and public address system; automatic signs on station platforms indicating train arrival and destination
Radio and dial telephone	Dial telephone, radio in trucks and work trains, walkie-talkie for trackside workers	Radio and dial telephone
Dial telephone	Dial telephone	Dial telephone
Dial telephone	Dial telephone	Dial telephone
Dial telephone	Radio and dial telephone	Radio and dial telephone
Police and fire each on separate radio network; utilities contacted by telephone	PATCO police on system radio network; outside police on separate network or contacted by telephone; fire and utilities contacted by telephone	BART police on system radio network; fire and utilities contacted by phone

GLOSSARY OF TRAIN CONTROL TERMS

The language of rail rapid transit and train control technology contains many specialized terms that may be unfamiliar to the general reader. This glossary has been prepared as an aid to understanding the terminology used in the report. It is also contemplated that the glossary may be useful as a reference for additional reading on the subject of ATC and transit system engineering. For this reason, the list of terms defined here has been expanded to include some background items not needed for the immediate purpose of reading this report.

The principal source of the definitions presented here is the Lexicon of Rail Rapid Transit Safety-Related Terminology, prepared by the Safety Technology Applied to Rapid Transit (START) Committee of the American Public Transit Association, January 1975. The START Lexicon, in turn, draws extensively on earlier work by the Association of American Railroads and the U.S. Department of Transportation. In addition to START, other sources consulted include General Order No. 127 of the Public Utilities Commission of the State of California, August 1967, and several technical specifications prepared by WMATA. In all cases, however, the responsibility for interpretation and for the accuracy and completeness of the definitions offered here rests with the authors of this report.

ACKNOWLEDGING DEVICE—a manual device used by the train operator to forestall automatic brake application on a train equipped with automatic train stop or to silence the sounding of a cab indicator on a train equipped with cab signaling. (See Audible Cab Indicator.)

ASPECT—the visual indication presented to an approaching train by a wayside signal; also, the display presented by a cab signal to an operator in the cab. The aspect is said to be “clear” (proceed at civil speed) or varying degrees of “restrictive.”

False Clear Aspect—the aspect of a signal that conveys an indication less restrictive than intended.

False Restrictive Aspect—the aspect of a signal that conveys an indication more restrictive than intended.

ATTENDANT—a transit employee on board a train in service whose principal duties are to oversee safety, provide security, and assist in emergency situations (as distinct from a train operator, motorman, who is responsible for running the train).

AUDIBLE CAB INDICATOR—an alerting device, on a train equipped with cab signals, designed to sound when the cab signal changes and to continue sounding until acknowledged. (See Acknowledging Device.)

AUDIO-FREQUENCY TRACK CIRCUIT—a track circuit energized by an electrical current alternating in the audio-frequency range (15,000-20,000 Hz); also called “high frequency” or “overlay” track circuit.

AUTOMATIC BLOCK SIGNAL SYSTEM—a series of consecutive blocks governed by block signals, cab signals, or both, actuated by occupancy of the track or by certain conditions affecting the use of a block; such as an open switch or a car standing on a turnout and blocking the main track. (See also Block and Manual Block Signal System.)

AUTOMATIC CAR IDENTIFICATION—a system that automatically provides positive recognition and transmission of individual car numbers as they pass a fixed wayside point.

AUTOMATIC TRAIN CONTROL—the method (and, by extension, the specific system) for automatically controlling train movement, enforcing train safety, and directing train operations. ATC includes four major functions:

Automatic Train Protection (ATP)—assuring safe train movement by a combination of train detection, separation of trains running on the same track or over interlocked routes, overspeed prevention, and route interlocking.

Automatic Train Operation (ATO)--controlling speed, programmed station stopping, door operation, performance level modification, and other functions traditionally assigned to the train operator and conductor.

Automatic Train Supervision (ATS)—monitoring of system status and directing traffic movement to maintain the schedule or minimize the effect of delays.

Communication (CS)—interchanging information (voice, data, or video) between system elements separated by distance.

AVAILABILITY—the portion of time that a system is operating or ready for operation; mathematically, the probability that a system or system element will be operational when required, expressed as the ratio of mean time between failure to the sum of mean time between failure plus mean time to restore. [$A = \text{MTBF}/(\text{MTBF} + \text{MTTR})$] (See also Mean Time Between Failure and Mean Time to Restore.)

BASE PERIOD—the nonrush hour period of weekday transit system service. (See also Peak Period.)

BERTH—the space assigned for a train of specified length when stopped at a station platform or in a terminal zone. (See Terminal Zone.)

BERTHING—the positioning of a train in its assigned berth.

BLENDING—the automatic and simultaneous application of dynamic and friction braking, where the effort of each is continuously proportioned to achieve the required total braking effect.

BLOCK—a length of track of defined limits, the use of which is governed by block signals, cab signals, or both.

Absolute Block—a block into which no train is allowed to enter while it is occupied by another train.

Permissive Block--a block into which a train is allowed to enter even though occupied by another train.

BLOCK SIGNAL-See Signal.

BRAKE ASSURANCE—the function provided by a subsystem within the automatic train operation system that will cause the emergency brakes of a vehicle to be applied when the actual braking

rate of the vehicle is less than the braking rate requested by the automatic train control system.

BRAKING—the process of retarding or stopping train movement by any of various devices:

Dynamic Braking—a system of electrical braking in which the traction motors are used as generators and convert the kinetic energy of the vehicle into electrical energy, which is consumed in resistors and, in so doing, exert a retarding force on the vehicle.

Friction Braking—braking supplied by a mechanical shoe or pad pressing against the wheels or other rotating surface; also called “mechanical braking.”

Regenerative Braking—a form of electrical braking in which the current generated by the traction motor is returned to the traction power supply for use in propelling other trains. (In ordinary dynamic braking the generated power is dissipated in resistors.)

There are two methods of controlling brake application:

Closed-Loop Braking—continuous modulation (by means of feedback) under the direction of the automatic train operation system or the human operator. (See Closed-Loop Principle.)

Open-Loop Braking—braking without modulation through feedback from the ATO system.

BRAKING EMERGENCY—irrevocable unmodulated (open-loop) braking to a stop usually at a higher rate than that obtained with a full service brake application.

BRAKING, FULL SERVICE—a nonemergency brake application that obtains the maximum brake rate consistent with the design of the primary brake system. Full service braking can be released and reapplied.

BRAKING, SERVICE—braking produced by the primary train braking system,

CAB SIGNAL SYSTEM—a signal system whereby block condition and the prevailing civil speed commands are transmitted and displayed directly within the train cab. The cab signal system may

- be operated in conjunction with a system of fixed wayside signals or separately. (See also Signal.)
- CATENARY**—the wire or wires above the track (including the messenger, supports, and insulation) that carry electric energy for the propulsion of trains. (See also Contact Rail.)
- CENTRAL CONTROL**—the place from which train supervision and direction is accomplished for the entire transit system; the train command center.
- CIRCUIT, TRACK**—an arrangement of electrical equipment, including the rails of the track, that forms a continuous electrical path used for the purpose of detecting the presence of trains on the rails; the track circuit may also be used to communicate commands or other information between the wayside and the train.
- Check-In/Check-Out**—a track circuit system that detects the entrance of the front end of a train into a block and the departure of the rear end of a train from a block for the purpose of determining block occupancy.
- Coded Track Circuit**—a track circuit in which the feed energy is varied or interrupted periodically for the purpose of transmitting commands or instructions to the train or operating train detection apparatus.
- Fail-Safe Circuit**—a circuit designed to principles which will cause the actuated device to assume its most restrictive position (or a state generally known to be safe) when any element of the circuit or system fails.
- Vital Circuit**—an electrical circuit that affects the safety of train operation.
- CIVIL SPEED**—See Speed Limit.
- CLOSED-CIRCUIT PRINCIPLE**—the principle of circuit design employing a circuit that is normally energized and, on being deenergized or interrupted, causes the controlled function to assume its most restrictive condition.
- CLOSED-LOOP” PRINCIPLE**—the principle of control system design in which the response of a system (feedback) is continuously compared with the controlling signal to generate an error signal.
- CLOSING IN**—running a following train toward a leading train that is either stopped or running slower than the following train. (See also Closing up.)
- CLOSING UP**—running a following train to a position that will allow it to couple with a stopped leading train.
- COAST**—the moving condition of a car or train where the propulsion is inactive and, usually, a certain minimum braking is applied. (See also Freewheeling.)
- CONDUCTOR**—an attendant whose main function is to operate train doors.
- CONSIST (noun)**—the number, type, and specific identity of cars that compose a train.
- CONTACT RAIL**—a rail, mounted on insulators alongside the running rails, that provides electric energy for the propulsion of trains. (Also known as “Third Rail.”)
- CROSSOVER**—two turnouts, arranged to form a continuous passage between two parallel tracks.
- DEADMAN CONTROL**—a safety device that requires continuous pressure or activity to remain activated; used to detect the inattention or disability of a train operator.
- DEPARTURE TEST**—an operational test made in a yard or on a transfer track before permitting the unit to enter revenue service.
- DISPATCH**—to start a train into revenue service from a terminal zone, transfer track, or designated intermediate point.
- DISPATCHER**—a person at central control whose function is to dispatch trains, monitor train operation, and to intervene in the event of schedule disruption or when any change in service or routing is required. (Also called “Line Supervisor” or “Central Supervisor.”)
- DOWNSTREAM**—for a given direction of travel, locations that will be reached after passing a given point (equivalent to the AAR term “in advance of”).
- DWELL (or DWELL TIME)**—the elapsed time from the instant a train stops moving in a station until the instant it resumes moving.
- ENTRANCE—EXIT ROUTE CONTROL**—a system of interlocking control that automatically aligns switches and clears signals to form a train route in response to manual inputs designating

- the entrance and exit points of the desired route. (Also called "N-X.")
- FACING MOVEMENT**—the movement of a train over points of a switch which face in the direction in which the train is moving. (See also *Trailing Movement*.)
- FAIL-SAFE**--a characteristic of a system which ensures that a fault or malfunction of any element affecting safety will cause the system to revert to a state that is known to be safe; alternatively, a system characteristic which ensures that any fault or malfunction will not result in an unsafe condition.
- FALSE OCCUPANCY**--an indication of track occupancy when no train is present.
- FREEWHEELING**-a mode of operation in which the train is allowed to roll freely without tractive or braking effort being applied. (See also *Coast*.)
- FREQUENCY SHIFT KEYED (FSK)**--a technique used with high-frequency a.c. track circuits, in which the frequency of the track signal is varied between two or more discrete states to convey information (used as an alternative to rate modulation where the track circuit is turned on and off as an information code).
- FROG**-a track structure, used at the intersection of two running rails, to provide support for wheels and passageway for their flanges, thus permitting wheels on either rail to cross the other. A frog may either be fixed or have movable points like a switch.
- GATE**—the limit of an interlocked route where entry to that route is governed by a signaling device.¹⁰²
- Fixed Gate--the limit of an interlocked route beyond which automatic operation of trains is never permitted.
- HEADWAY**—the time separation between two trains traveling in the same direction on the same track, measured from the instant the head end of the leading train passes a given reference point until the head end of the train immediately following passes the same reference point.
- HOSTLER**-an employee assigned to operate cars or trains manually within the yard or maintenance area.
- Hz (HERTZ)**—the unit of frequency equal to 1 cycle per second.
- IMPEDANCE BOND**-a device of low resistance and relatively high reactance, used to provide a continuous path for the return of propulsion current around insulated joints and to confine alternating current signaling energy within a track circuit.
- INDUCTIVELY COUPLED IMPEDANCE BOND**--an impedance bond in which transmitter energy and receivers are inductively coupled into a track circuit,
- INSULATED JOINT**-a joint placed between abutting rail ends to insulate them from each other electrically.
- INTERLOCKING**--an arrangement of signals and control apparatus so interconnected that functions must succeed each other in a predetermined sequence, thus permitting train movements along routes only if safe conditions exist.
- Automatic Interlocking-an interlocking controlled by logic circuits so that movements succeed each other in proper sequence without need for manual activation or control.
- Manual Interlocking—an interlocking operated manually from an interlocking machine, so interconnected (either mechanically or electrically) that movements succeed each other in proper sequence.
- Relay Interlocking-an interlocking in which locking is accomplished electrically by interconnection of relay circuits.
- INTERLOCKING LIMITS**—the length of track between the most remote opposing home signals of an interlocking.
- INTERLOCKING MACHINE**-an assemblage of manually operated levers or like devices for controlling the switches, signals, and other apparatus of an interlocking. (Also called "Switch Machine,")
- INTERLOCKING ROUTE**-a route between two opposing interlocking signals.
- JERK**—the rate of change of acceleration (the second derivative of velocity), expressed in units of miles per hour per second per second (mphsps, mph/see/see, or mph/sec²).
- JUNCTION**-a location where train routes converge or diverge.

¹⁰²These terms are peculiar to the BART system.

KEY-BY—the act of lowering a trip stop in order to pass a signal displaying a stop indication; so called because of the use at one time of a key by the train operator to actuate the mechanism for lowering the trip stop. Key-by today operates automatically without a key,

LOCKING—establishing an electrical or mechanical condition for a switch, interlocked route, speed limit, or automatic function such that its state cannot be altered except by a prescribed and inviolate sequence of actions.

Approach Locking—electric locking effective while a train is approaching within a specified distance a signal displaying an aspect to proceed and which prevents, until after the expiration of a predetermined time interval after such signal has been caused to display its most restrictive aspect, the movement of any interlocked or electrically locked switch, movable point frog or derail in the route governed by the signal and which prevents an aspect to proceed from being displayed for any conflicting route.

Electric Locking—an electrical circuit arrangement by means of which levers of an interlocking machine, switches, or other signal apparatus is secured against operation under prescribed conditions.

Indication Locking—electric locking which prevents actions that would result in an unsafe condition for a train movement if a signal, switch, or other operative unit fails to make a movement corresponding to that of its control.

Occupancy Detector Locking—electric locking which prevents the movement of a track switch while the track circuit or circuits surrounding that switch are occupied by a train.

Route Locking—electric locking, effective when a train passes a signal displaying an aspect for it to proceed, that prevents the movement of any switch in the route governed by the signal and prevents the clearing of a signal for any conflicting route.

Time Locking—electric locking that prevents the operation of any switch in the route (or

for any conflicting route) until expiration of a predetermined time interval after a signal is restored to its most restrictive indication.

Traffic Locking—electric locking which prevents the actuation of devices for changing the direction of traffic on a section of track while that section is occupied or while a signal displays an aspect for a movement to proceed into that section,

Sectional Release Locking—a route locking so arranged that, as a train clears a section of the route, the locking affecting that section is released. (Also called “Trailing Release Locking.”)

MAINTAINABILITY—the property of a system that allows it to be repaired and restored to operating condition after a component malfunction or failure; maintainability is often expressed as mean time to restore (or repair).

MANUAL BLOCK SIGNAL SYSTEM—a block signal system operated manually, usually based on information transmitted by telephone or telegraph.

MARRIED PAIR—two semipermanently coupled cars that share certain essential components and are usually operated as a unit.

MASTER CONTROLLER—a carborne device that generates control signals to the propulsion and braking systems,

MEAN TIME BETWEEN FAILURES (MTBF)—the average time that a system or component will operate without failure or malfunction; mathematically, $MTBF = (\text{operating time}) / (\text{number of failures})$. MTBF is the measure of reliability.

MEAN TIME TO RESTORE (MTTR)—the average time required to restore a system or component to operation after a failure; this time is measured from the time troubleshooting and repair work is begun until the system or component is again operable; mathematically, $MTTR = (\text{cumulative corrective maintenance time}) / (\text{number of failures})$. MTTR is the measure of maintainability,

MODEL BOARD—a reproduction of the track assemblage (not necessarily to scale) equipped with lights and other indicators, used for the pur-

pose of train supervision and traffic control (Also called "Train Board").

MOTORMAN-See Operator.

MTBF-See Mean Time Between Failures.

MTTR-See Mean Time to Restore.

NORMAL DIRECTION—the prescribed direction of train traffic as specified by the rules; usually, the direction in which all regularly scheduled revenue service operations are conducted.

N-X-See Entrance-Exit Route Control.

OPERATOR—the transit employee on board the train having direct and immediate control over the movement of the train. (Also called "Motor-man.")

OPPOSING TRAIN—a train moving in the direction opposite to another train on the same track.

OVERSPEED CONTROL—that onboard portion of the carborne ATC system that enforces speed limits in a fail-safe manner.

PABX—a designation used in the national telephone system to denote a privately owned telephone system that operates by the use of dialing, such as that used in some transit systems for communication between stations or wayside locations and central control.

PEAK PERIOD—the period during a weekday when system demand is highest; usually 7:30-9:30 a.m. and 4:30-6:30 p.m. (Also called "Rush Hour.") (See also Base Period)

POINT-See Switch Point.

PROPERTY—literally, the right-of-way, track, structures, stations, and facilities owned or operated by a transit agency; but used generally as a synonym for the operating agency itself. (See also Territory.)

RAIL RAPID TRANSIT—a mode of transportation operating in a city or metropolitan area and high-speed speed passenger cars run singly or in trains on fixed guideways in separate rights-of-way from which all other vehicular and foot traffic is excluded. Tracks may be located in underground tunnels, on elevated structures, in open cut, or at surface level. There are very few, if any, grade crossings; and rail traffic has the right-of-way at such intersections. Cars are driven electrically with power drawn from an

overhead electric line by means of pantograph or from an electrified third rail. Rail rapid transit may use steel wheels on steel rails or pneumatic tires on wooden, steel, or concrete guideway.

RELAY—a device operated by variation in the condition of one electric circuit and used to effect the operation of other devices in the same or another circuit; commonly, an electromagnetic device to achieve this function.

Track Relay—a relay receiving all or part of its operating energy through conductors having the track rails as an essential part.

Vital Relay—a relay, meeting certain stringent specifications, designed so that the probability of its failing to return to the prescribed state after being deenergized is so low as to be considered, for all practical purposes, nonexistent.

RELIABILITY—the probability that a system or component thereof will perform its specified function without failure and within prescribed limits; reliability is often expressed as a mean failure rate (MTBF).

REVENUE SERVICE—transportation of fare-paying passengers on main line routes.

REVERSE DIRECTION—train movement opposite to the normal direction. (See Normal Direction.)

REVERSE RUNNING—operation of a train in the reverse direction.

ROUTE—a succession of contiguous blocks between two controlled gates or interlocked signals.

Conflicting Routes—two or more routes (opposing, converging, or intersecting) over which movements cannot be made simultaneously without possibility of collision.

Normal Route—a prescribed route, a route in the normal direction of train travel.

Reverse Route—a route opposite to the normal route.

ROUTE REQUEST—registration at an interlocking of a desired interlocked route.

RUNTHROUGH—intentionally passing a station platform without making a scheduled stop.

SEMAPHORE-a wayside signal device by which indications are given by the position of a movable arm in daylight hours and by the color of a light in darkness.

SHUNT-a conductor joining two points in an electrical circuit so as to form a parallel or alternate path through which a portion of the current may pass.

SHUNTING SENSITIVITY-the maximum impedance that, when placed at the most adverse shunting location, will cause the track circuit to indicate the presence of a train.

SIDING—a track auxiliary to the main track, used for meeting, passing, or storing trains.

SIGNAL-a means of communicating direction or warning.

Block Signal-a fixed signal at the entrance of a block governing trains entering and using that block,

Cab Signal--a signal in the train operator's cab that governs the movement of that train by conveying the automatic block aspects and the prevailing speed command.

Clear Signal--a signal displaying the aspect indicating to proceed.

Home Signal-a fixed signal at the entrance of a route or block governing trains entering and using that route or block.

Opposing Signals-wayside signals governing train movements in opposite directions over the same stretch of track.

Time Signal-a signal that controls train speed by requiring that a certain time elapse between entering and leaving a block.

Wayside Signal-a signal of fixed location along the track right-of-way.

SIGNAL ASPECT-See Aspect.

SLIDE (WHEEL)—the condition, during braking or deceleration, where the surface speed of the wheel is less than train speed,

SLIP (WHEEL)—the condition, during acceleration, where the surface speed of the wheel is greater than train speed. (Also called "Spin.")

SLIP-SLIDE SYSTEM-an onboard system for automatically detecting and correcting slip and slide by making compensating adjustments of propulsion and braking to maintain optimum traction (wheel-rail adhesion),

SPEED

Civil Speed (Limit)—the maximum speed allowed in a specified section of track as determined by physical limitations of the track structure, train design, and passenger comfort.

Safety Speed (Limit)—the maximum speed at which a train can safely negotiate a given section of track under the conditions prevailing at the time of passage. (Safety speed may be less than or equal to civil speed.)

Schedule Speed-the speed at which a train must operate to comply with the timetable; mathematically, the distance from terminal to terminal divided by the time scheduled for the trip (including station stops),

SPEED PROFILE-a plot of speed against distance traveled.

SPEED REGULATOR-an onboard subsystem, usually part of the automatic train operation (ATO) system, that controls acceleration and braking to cause the train to reach and maintain a desired speed within a given tolerance,

SPIN-See Slip.

STOP

Emergency Stop-stopping of a train by an application of the emergency brake, which—after initiation-cannot be released until the train has stopped.

Full Service Stop-a train stop achieved by a brake application, other than emergency, that develops the maximum brake rate.

Penalty Stop--irrevocable open-loop braking initiated by an onboard automatic system or by a wayside trip stop as a result of a block violation or uncorrected overspeed.

Programed Stop-a train stop produced by closed-loop braking such that the train is stopped at a designated point according to a predetermined speed-distance profile.

- Stop Signal--a signal indication requiring a train to stop and stay stopped and permitting no exceptions such as running at reduced speed, movement within restricting limits, or similar alternatives.
- Train Protection Stop-a train stop initiated by the automatic train protection (ATP) system.
- SWITCH—a device that moves rails (switch points) laterally to permit a train to transfer from one track to another. (See also Frog,)
- Facing Point Switch-a track switch with points facing toward approaching traffic.
- Trailing Point Switch-a track switch with points facing away from approaching traffic.
- SWITCH POINT-a movable tapered track rail, with the point designed to fit against the stock rail.
- TERMINAL ZONE-a length of track, within which the prescribed running direction can be reversed while it is occupied by a train,
- TERRITORY—that portion of a route or route network characterized by a particular mode of operation or type of equipment, e.g., cab signal territory, multiple track territory,
- THIRD RAIL-See Contact Rail.
- TRACK
- Double Track—two parallel tracks, usually with each reserved for running in one direction only.
- Main Track-a track extending through yards and between stations, upon which trains are operated in revenue service or the use of which is governed by signals.
- Reversible Track--a section of track on which the prescribed direction of running can be reversed if it is unoccupied and the opposing home signals are at stop.
- Single Track--a main track on which trains are operated in both directions.
- Transfer Track-a track in a yard area where transfer between main track and yard modes of operation takes place.
- TRACK CIRCUIT—(See Circuit, Track,)
- TRAFFIC REGULATION--a train supervisory function making use of changes in dwell time, performance level, acceleration rates, or other train performance characteristics to maintain intended traffic patterns and system stability,
- TRAIN-a consist of one or more cars combined into an operating unit, (See also Consist.)
- TRAIN BOARD—(See Model Board.)
- TRAIN DETECTION EQUIPMENT—the track circuits and associated apparatus used to detect the presence of trains in blocks,
- TRAIN IDENTIFICATION-a method of designating trains by means of such information as train number, destination, or length; may be accomplished automatically for functions such as routing or dispatching.
- TRAIN ORDERS—instructions used to govern the movement of trains manually, usually written and hand-delivered,
- TRANSFER ZONE-a zone where changeover from manual to automatic operation, or vice versa, may be made. (See also Transfer Track, under Track.)
- TRIP STOP-a mechanical arm, located on the wayside, that can initiate a penalty brake application on a train that passes it by engaging a brake-triggering device (trip cock) on the train. Trip stops may be fixed, i.e., permanently positioned in the tripping position; or they may be raised and lowered in response to signal indications,
- TURNBACK POINT-a point along the track, not at a terminal, where a train may reverse direction if allowed by the train control system, (See also Terminal Zone,)
- TURNOUT-an arrangement of switch points and frog with closure rails that permits trains to be diverted from one track to another,
- UPSTREAM—track locations that, for a given reference point and direction of travel, lie behind the train and have been passed by it.
- YARD-a network of tracks for making up trains and storing cars.

CHRONOLOGY OF TRAIN CONTROL DEVELOPMENT

The history of train control technology in rail rapid transit is interwoven with railroad engineering. Most of the train control techniques applied in rail rapid transit have their origin in railroading, from which they are either borrowed directly or adapted to the special circumstances of the urban setting. For this reason, many train control engineers consider ATC in rail rapid transit simply an extension of the field of railroad signaling. However, there are some distinct differences, both in the technology and its application. The similarities and differences are evident in the chronology of train control development presented here.

The development of signaling and train control technology may be separated into two periods, with 1920 as the dividing point. Before 1920 the major areas of technological advance were interlocking control and block signaling (manual and automatic). After 1920, the demand for moving heavier traffic at higher speeds and with increased safety led to major developments such as centralized traffic control, continuous cab signaling, coded track circuits, and automatic train control. Generally, innovative signaling and train control technology for rail rapid transit was derived from railroads and lagged behind railroad application by about 10 years. There were some notable exceptions; the development of automatic junction operation and automatic train dispatching was pioneered in rail rapid transit. Very recently, since roughly 1960, there has been some experimentation with techniques and equipment solely for rail rapid transit and small people-mover systems.

The major source of this material is *American Railway Signaling Principles and Practices, Chapter I—History and Development of Railway Signaling*, published by the Association of American Railroads, Signal Section, 1954. Supplementary information, particularly on rail rapid transit technology in recent years, was assembled from various sources, including manufacturer's brochures, local transit agency reports, and technical journals.

- 1832 The first fixed signal system in America was installed on the New Castle & Frenchtown RR. The signals were ball-shaped objects mounted on masts at 3-mile intervals. The signals were raised and lowered by a signalman to indicate permissible speed—low meaning stop and stay and high meaning proceed at full speed. The latter indication gave rise to the expression “highballing.”
- 1843 The first mechanical interlocking was installed at Bricklayer's Arms Junction in England. It was a simple machine operated by a signalman who worked the switches with his hands and the signals with his feet.
- 1851 Morse code electric telegraph was first used in train operation for sending train orders on the New York & Erie RR.
- 1853 The Philadelphia & Reading RR installed signal towers for giving information to approaching trains on the occupancy of the track in advance.
- 1853 Open-circuit manual block signaling was first used in England.
- 1860 Gate signals were initiated in America. A stop indication was displayed by placing a red banner or disc on top of the gate during the day. A red light was displayed at night.
- 1863 Closed-circuit (fail-safe) manual block signaling, using the space interval method of operation, was first employed in America on the United New Jersey Canal & RR Co. between Kensington, Pa. (Philadelphia), and Trenton, N.J.
- 1866 The first automatic electric block system was installed on the New Haven System at Meriden, Conn. Hall enclosed disc signals, open circuit, were operated by track instruments.

- 1868 The Pennsylvania RR used a type of train order signal which was under the control of the train dispatcher who could set it in the stop-danger position at any remote station by means of a selective device operated over the regular Morse telegraph circuit.
- 1870 The first interlocking machine in America was installed at Top-of-the-Hill, a junction at Trenton, N. J., on the Camden and Amboy Division of the Pennsylvania RR.
- 1871 A system of automatic block signals, comparable with presently used equipment, was installed on the New York & Harlem RR and the Eastern RR.
- 1872 The first installation of closed d.c. track circuit, invented by Dr. William Robinson, was made at Kinzua, Pa., on the Philadelphia & Erie RR.
- 1873 The Robinson closed-circuit track block for switch protection was first put into use on the Philadelphia & Erie RR.
- 1876 The first power interlocking of the Burn pneumatic type was put in use on the Pennsylvania RR at Mantua "Y," West Philadelphia, Pa.
- 1876 The Boston & Lowell and the Boston & Providence RRs introduced the Robinson electromechanical signal for **automatic** blocking, controlled by direct current track circuits.
- 1880 The first automatic train stop was placed in trial service on the Middle Division of the Pennsylvania RR. A glass tube in the train air line located on the locomotive near the rails was designed to be broken by a "track trip" set in operating position when the signals were in the stop position.
- 1881 The first interlocking of the hydraulic type was installed by the Union Switch & Signal Co. at Wellington, Ohio, for a crossing of the Wheeling & Lake Erie Ry. with the Cleveland, Cincinnati, Chicago & St. Louis Ry.
- 1885 The "Dutch Clock" device for establishing time intervals (headways) between trains was in use on the New York, New Haven & Hartford RR and the New York Central & Hudson River RR. When operated automatically by a treadle device on the rail, the passing train released a pointer which started to move around a dial divided into three segments each representing 5 minutes. The pointer movement was controlled by an escapement so that it moved across the dial in a period of 15 minutes. Headway for the train ahead was thus indicated up to 15 minutes.
- 1885 The first electric detector locking for interlocked track switches was installed by the Pennsylvania RR at the Pittsburgh, Pa., terminal by using depression trips to ground the indication circuit.
- 1889 The first electric interlocking employing dynamic indication, invented by John D. Taylor, was installed at East Norwood, Ohio, at the crossing of the Baltimore & Ohio Southwestern RR and the Cincinnati and Northern RR.
- 1893 The first low-voltage, direct-current, motor-operated automatic semaphore block signals were installed on the Central RR of New Jersey in Black Dan's Cut, east of Phillipsburg, N.J. They were two-position lower-quadrant signals with the motor and driving chain outside the mast.
- 1900 The first three-block indication was installed on the Pennsylvania RR between Altoona and Cresson, Pa. The signals were two-position, lower-quadrant, home and distant automatic semaphores,
- 1900 In Acton Town, England, an illuminated track diagram was first used in connection with resignaling on the District Ry. due to electrification, It dispensed with separate track indicators and brought together all track occupancy information on the plan of tracks and signals, thereby facilitating the work of the signalman handling traffic.
- 1901 The Taylor Signal Co. put in service the first electric interlocking embodying the "dynamic indication" principle, at Eau

- Claire, Wis., on the Chicago, St. Paul, Minneapolis & Omaha Ry.
- 1901 The Boston Elevated installed special polarized d.c. track relays. This was the first attempt to operate track circuits on a railroad where propulsion power was supplied by electricity and the rails were used as the medium for current return.
- 1901 The Boston Elevated made the first permanent installation of an automatic train stop system, which consisted of mechanical wayside trips engaging brake control apparatus on the moving car.
- 1903 The North Shore RR of California made the first installation of a.c. track circuits for automatic block signals.
- 1906 The first signal system with a.c. track circuits on a road using a.c. propulsion power was installed on the New York, New Haven & Hartford RR, The track circuits were the two-rail type, 60 Hz, with impedance bonds. Propulsion current was 25 Hz.
- 1907 The first automatic interlocking for the protection of a railroad crossing was installed at Chester, Va., at a crossing of the Tidewater & Western Ry. with the Virginia Railway, Power & Light Co.
- 1909 The Erie RR installed automatic signaling for train operation by signal indication on a two-track division, 139.7 miles in length, which directed trains to: (1) stop and hold main track, (2) take siding, (3) proceed on main track regardless of superior trains.
- 1911 The absolute permissive block system (APB), developed by the General Railway Signal Co., was first installed on the Toronto, Hamilton & Buffalo RR between Kinnear and Vinemount, Ontario, Canada, using direct-current semaphore signals.
- 1912 Train movements on the Chesapeake & Ohio Ry. were directed for the first time by signal indication without written train orders.
- 1912 Cab signals were first used on an electric railway, the Indianapolis & Cincinnati Traction Co.
- 1914 The cam controller for control of power application to d.c. propulsion motors was first used in the Chicago Rapid Transit co.
- 1915 The American Railway Association adopted rules which permitted train operation on single track by controlled manual block signal indications, superseding timetable and train orders.
- 1919 The Buffalo, Rochester & Pittsburgh Ry. made the first trial installation of the General Railway Signal Co. intermittent inductive train stop system. This system used magnetic induction to transfer signals from wayside controls to train equipment.
- 1920 The first installation of automatic speed control in the US. was that of the Regan Safety Device Co. intermittent electrical contact ramp-type train control system on the Chicago, Rock Island & Pacific RR between Blue Island and Joliet, Ill.
- 1923 The Pennsylvania RR placed in service, experimentally, the first installation anywhere of the continuous inductive cab signal and train control system covering 43.5 miles of single track and 3.4 miles of two-track, between Lewistown and Sunbury, Pa. It was the first instance where vacuum tubes were used for purposes other than in communication circuits. This installation also was the first time that cab signals were used in lieu of wayside signals for operating trains by signal indication.
- 1925 The first permanent installation of cab signals without wayside automatic block signals was made on the Atchison, Topeka & Santa Fe Ry., between Chillicothe, Ill., and Ft. Madison, Iowa. The equipment was a Union Switch & Signal Co. three-speed continuous inductive-type train control device.
- 1926 The Illinois Central RR was the first to equip an operating division with automatic train stop and two-indication

- continuous cab signals without wayside automatic block signals,
- 1927 The first General Railway Signal Co. centralized traffic control system was installed on the New York Central RR between Stanley and Berwick, Ohio. The first dual-control electric switch machines, which provided for either hand or electric operation, were introduced on this installation,
- 1930 The first use of the all-relay interlocking principle, as a substitute for indication parts and magnets at the levers of a large interlocking machine equipped with mechanical locking, was at Cleveland Union Terminal, Ohio,
- 1931 The New York Central RR installed a system of four-block indication signals on a line equipped with automatic block signals in heavy suburban traffic territory.
- 1932 The Philadelphia subways installed a modified type of the three-wire circuit code scheme of centralized traffic control.
- 1933 The Pennsylvania RR was granted permission by the ICC to convert all its locomotives equipped with the coded continuous train stop system to the coded continuous cab signal system with whistle and acknowledger. This was done with the understanding that the Pennsylvania RR would voluntarily extend cab signal territory to include most of its main line trackage.
- 1934 The first installation of coded track circuits on steam-operated territory was made between Lewistown and Mt. Union, Pa., on 20 miles of four-track main line on the Pennsylvania RR. The average length of track circuit was 5,201 feet. Energy was coded storage battery for three and four-indication wayside signals, with coded 100 Hz a.c. superimposed for continuous cab signals,
- 1937 The first installation of a relay-type interlocking with push-button automatic selection of routes and positioning of switches and signals, General Railway Signal Co. Type "N-X" (entrance-exit), was made at Girard Junction, Ohio, on the New York Central RR.
- 1939 A four-indication, four-speed coded, continuous train control system was installed on suburban cars of the Key System, Southern Pacific and Sacramento Northern Railroads operating over the San Francisco-Oakland Bay Bridge, California. The system was designed to handle 10-car multiple-unit trains operating on a 1-minute headway. The installation included an N-X interlocking system with a train describer and automatic operation of a single switch.
- 1939 The first application of coded detector track circuits in interlocking was made by the Norfolk & Western Ry.
- 1940 The first installation of coded track circuits for continuous cab signaling without wayside automatic signals in steam territory, developed by the Union Switch & Signal Co., was made between Conpit and Kiskiminetas Junctions, Pa., on the Pennsylvania RR,
- 1940 The Pennsylvania RR installed a centralized traffic control system between Harmony and Effingham, Ill., using the Union Switch & Signal Co. two-wire, 35-station time code type for the first time on a multiple-connected line circuit in which the line wires were continuous throughout the territory, and which provided for the coordination of the code circuit and communication circuits over the same line wires. This was the first installation of a centralized traffic control system to employ a two-wire code line circuit in which all the field locations were connected in multiple across the line wires,
- 1940 The first installation of reversible coded track circuits in single-track territory with centralized traffic control was made between Machias and Hubbard, N.Y., on the Pennsylvania RR.
- 1940 The first installation of absolute permissive block (APB) signaling with three and four indications with coded track

- circuits was made on the Norfolk & Western Ry., between Petersburg and Evergreen, Va.
- 1943 The first installation of coded track circuits using polar reverse codes with three-indication signaling for either-direction operation was made on the St. Louis Southwestern Ry.
- 1944 The first installation of normally deenergized coded track circuits for centralized traffic control on single track was placed in service between Laredo and Polo, Me., on the Chicago, Milwaukee, St. Paul & Pacific RR.
- 1946 The Pennsylvania RR demonstrated the feasibility of centralized traffic control operation over commercial communication circuits, including beamed radio. The test was made over approximately 1,130 miles of Western Union carrier telegraph circuit including about 90 miles of beamed radio. This was the first time beamed radio was used for this purpose.
- 1948 The first use of automatic train dispatching in rail rapid transit was by the Philadelphia Rapid Transit Co. (now SEPTA). The device employed a perforated opaque tape driven by a clock mechanism. A beam of light scanning the tape triggered a photoelectric cell that automatically activated starting lights at terminals.
- 1949 The Chicago Transit Authority initiated experiments in the use of radar for train detection and separation assurance.
- 1951 The Pennsylvania RR installed a three-speed continuous inductive train control system in which the limits were 20 miles per hour with no code, 30 miles per hour with 75 code, 45 miles per hour with 120 code, and no speed limit with 180 code.
- 1951 CTA began the use of automatic train dispatching with remote override capability from central locations. The system, which employs a mechanical clock, pen graph recorders of train movement, and line supervision, is still in operation.
- 1951 A portable radio, called "Dick Tracy," was first used by yard switchmen on the Southern Ry. in connection with coupling cars in the classification yard and transferring them to the departure yard.
- 1952 The Erie RR placed in service at Waterboro, N. Y., in connection with the establishment of a remotely controlled interlocking, a system of automatic train identification. This system automatically identifies the direction and the number of a train as it clears a manual block on a branch line.
- 1953 The first installation of cab signaling using transistors in place of vacuum tubes was placed in service on the New York, New Haven & Hartford RR by the General Railway Signal Co.
- 1953 The first installation using transistors instead of vacuum tubes in safety-type (vital circuit) carrier equipment was made on the Pennsylvania RR. The equipment was developed by the Union Switch & Signal Division of Westinghouse Air Brake Co.
- 1955 A crewless remote-controlled passenger train was demonstrated on the New York, New Haven & Hartford RR.
- 1959 The inductive train phone was first used in rail rapid transit by the Chicago Transit Authority.
- 1961 A completely automatic subway train was placed in service on the shuttle run between Times Square and Grand Central Station in New York. A motorman was on board for emergencies, but he was not involved in normal operation of the train and often spent his time reading the newspaper.
- 1962 A crewless freight train operating system was tested on the Canadian National RR.
- 1964 Automatic train operation (ATO) equipment, intended for use in the BART system, was operationally tested at Thorndale on the Chicago Transit Authority North-South route.

- 1966 Four automatic train control systems for BART were demonstrated at the Diablo test track--one using the moving block concept, two using coded track circuits, and the other using a "trackwire" communications link and wayside control equipment.
- 1966 Fully automated vehicle operation and innovative methods of train control were demonstrated for the Transit Expressway (Skybus) system at South Park, Pa., by the Port Authority of Allegheny County (Pittsburgh).
- 1967 Audio-frequency track circuits in a rail rapid transit application were first placed in regular service by the Chicago Transit Authority.
- 1969 Revenue service was begun on the PATCO Lindenwold Line. After a manually initiated start, train operation is completely automatic until the doors are opened at the next station.
- 1971 An automatic people-mover system was placed in operation at the Tampa Airport. This system incorporates some of the ATC elements originally demonstrated at South Park,
- 1972 Four automatic people-mover systems were demonstrated at TRANSPO '72, Washington, D. C., under the auspices of the U.S. Department of Transportation.
- 1972 Revenue service was initiated on the Fremont-MacArthur portion of the BART system. Train operation, including start, berthing, and door operation, is entirely automatic but under the supervision of an onboard operator,
- 1973 The Satellite Transit System, featuring automatic crewless vehicle operation, was placed in service for passengers at the Seattle-Tacoma (Sea-Tac) Airport.
- 1974 The AIRTRANS system at Dallas/Ft. Worth Airport opened for service. Operating on 17 interconnected routes, AIRTRANS has automatic crewless trains to carry passengers, baggage, freight, and refuse within the airport complex.
- 1974 Demonstration of the Morgantown (W, Va.) PRT system was conducted. Small vehicles, operating on a fixed guideway, circulate under automatic control and without onboard operators,

PERSONS AND ORGANIZATIONS VISITED

During the course of this study, visits were made to each operating transit agency and to other organizations with an interest in the design and operation of rail rapid transit systems. The following is a list of the persons interviewed and their organizational affiliation. Individual recognition of their contributions to the study is not possible, except in a few cases where their observations are cited directly in the report. The OTA staff and the Urban Mass Transit Advisory Panel are grateful for the cooperation of these people and for the generous gift of their time and interest. Persons interviewed by the OTA staff are listed on the left. Those interviewed by the technical consultants, Battelle Columbus Laboratories, are listed on the right.

OPERATING TRANSIT AGENCIES

Boston—Massachusetts Bay Transportation Authority (MBTA)

Jason B. Baker Supt., Equipment Engineering	Larry Bulongie Signals and Communications
Francis X. Capelle Deputy Supt., Signals and Communications	James A. Burns General Supt., Equipment Maintenance
Joseph P. Dyer General Supt., Power and Signals	Raymond M. Caddigan Supt. of Rail Lines
William Malone Safety Department	Francis X. Capelle Deputy Supt., Signals and Communications
David Marcham Transportation Department	Frank Crowley Deputy Supt., Maintenance
	Col. Warren J. Higgins Director of Operations
	Larry Maddalena Electrical Supervisor

Chicago-Chicago Transit Authority (CTA)

Joseph Bensen Librarian	Kendrick Bisset Supervisor, Signal Design .
James Blaa Manager of Transportation	Paul Cleaver Supt., Signals and Communications
Thomas Boyle Director of Safety	Arthur Sandberg Manager, Engineering
Albert Brandt Signal Maintainer, Lake-Harlem Shops	James Stewart Manager, Equipment Engineering
Daphne Christensen Science Advisor to the Chairman of the Board	Ralph Tracy Director of Transportation Services

Paul C. Cleaver
Supt., Signals and Communications

Adel El Dib
Management Systems

Judy Genneson
Librarian

Edward Henry
Public Safety

Harold Hirsch
Manager of Operations Planning

Paul Kole
General Manager, Finance

George Krambles
General Manager, Operations

Herbert Lowenstein
District Supervisor (North)

Katherine Moriarty
Supervisor, Collection Agents

Evan C. Olmstead
Manager of Maintenance

A. R. Sandberg
Manager of Engineering

Theodore Szewc
Supervisor, Signals Maintenance

Ralph Tracy
Director of Transportation Services

Joanne Vlecidis
Development Planning

Thomas Wolgemuth
Director, Plant Maintenance

Chicago—Illinois Department of Transportation

B. G. Cunningham
Former Assistant Secretary of
Transportation (Illinois DOT)

Cleveland—Cleveland Transit System (CTS)

Elmer Corlett
Director of Personnel

Bernard Hamper
Employment Supervisor

Leonard Kraynik
Chief Research Analyst

Michael McKenna
Supt., Power and Plant

Philip Rockwood
Manager of Maintenance

Myron Silsby
Supt. of Rapid Transit

Bernard Wilchek
Supervisor of Management Development,
Training and Safety

Dear Williamson
Manager of Operations

Donald Yuratovac
Research Specialist, Research and Planning

New York—New York City Transit Authority (NYCTA)

Charles Kalkhof
Assistant General Superintendent,
Maintenance of Way

William O'Neill
Asst. Supervisor of Signals

Louis Alessi
Assistant Supervisor,
Car Maintenance

Frank T. Berry
Executive Officer, Operations
and Maintenance

Joseph Calderone

Irwin Cohen

Frank De Maria
Supt. of Rapid Transit

Seymour Dornfeld
Division Engineer, Signals and
Communications

Donald Gill
Chief Industrial Engineer

Charles Kalkhof
Assistant General Superintendent,
Maintenance of Way

Harold J. McLaughlin
Assistant General Supt., Rapid
Transit Transportation

Dennis Newman
Deputy Subdivision Engineer,
Maintenance of Way

Jack Rogg
Supt. of Engineering and Production
Control

Daniel T. Scannell
Senior Executive Officer, Operations
Management

Bart Sheehan
Railroad Signal Specialist,
Maintenance of Way

Ludwig Stanitsch
Senior Transit Management Analyst

Thomas Sullivan
Supt., Rapid Transit

Philadelphia, Camden—Port Authority Transit Corporation (PATCO)

David L. Andrus, Jr.
Supervisor of Traffic and Planning

Howard C. Conings
Safety and Insurance Supervisor

Robert B. Johnston
General Manager

Robert S. Korach
Assistant General Manager and Supt. of
Operations

John A. Lane
Administrative Assistant to the General
Manager

John J. McBride
Captain of PATCO Police

Herbert McCreary
Statistician

J. William Vigrass
Supt. of Equipment

James F. Elder
Supt. of Operations

Joe Fiori
General Foreman, Signals and Communications

Robert B. Johnston
General Manager

Robert S. Korach
Assistant General Manager and
Supt. of Operations

J. William Vigrass
Supt. of Equipment

D. R. Wolfe
Supt. of Way and Power

Clay Yost
Equipment Engineer

PATCO Consultants

Gibbs & Hill
Jack R. Shepard
Chief Systems Engineer (Ret.)

San Francisco—Bay Area Rapid Transit (BART)

Malcolm Barrett
General Counsel

Ward D. Belding, Jr.
Senior Economic Analyst

Ray Carroll
Director of Maintenance

Krishna Hari
Train Control Systems Engineer

George Anas
William Briner
Supt. of Line Operations

Ray Carroll
Director of Maintenance

Marvin Denowitz
Manager of Quality Control

Krishna Hari
Train Control Systems Engineer

Fred Harmon
Transportation Division

William F. Hein
Director of Planning

Mary-Lou Mulhern
Librarian

Eugene P. Nunes
Safety Supervisor

Philip O. Ormsbee
Assistant to General Manager

William M. Reedy
Former Member, BART Board

William J. Rhine
Director of Engineers

Ronald E. Rypinski
Supervisor of Maintenance Planning

George M. Silliman
Former Member, BART Board

BART Consultants

Hewlett-Packard
David Cochran
Leonard Cutler

Lawrence Berkeley Laboratory
Don M. Evans
D. Theodore Scalise

Roy W. Harris, TRW
Manager, BART Safety Availability Project

Clarence Lovell
Member, Special Panel, Public Utilities
and Corporations Committee, California
Senate

Bernard M. Oliver
Member, Special Panel, Public Utilities
and Corporations Committee, California
Senate

William Wattenburg
Independent Consultant

San Francisco—State of California

Alfred E. Alquist
Chairman, Public Utilities and
Corporations Committee,
California Senate

William F. Hein
Director of Planning

Mary-Lou Mulhern
Librarian

William J. Rhine
Director of Engineering

R. Somerton
Training Supervisor

BART Consultants

Parsons-Brinckerhoff-Tudor-Bechtel
Walter Quintin of the Bechtel Corp.
TRW

Hal Buchanan
Roy Harris, Project Manager
Everett Welker

James Cooney
Office of the Legislative Analyst

Wayne Keithley
Office of the Legislative Analyst

James R. Mills
Member, Public Utilities and
Corporations Committee,
California Senate

A. Alan Post
Legislative Analyst

San Francisco—California Public Utilities Commission

James K. Gibson
Director, Transportation Division

Leo L. Lee
Senior Electrical Engineer

William L. Oliver
Transportation Division

Herman W. Privette
Senior Transportation Supervisor

Theodore E. Rogers
Chief, Railroad Operations and
Safety Branch

In addition to contacts with the preceding people and organizations who are involved in operating transit agencies, OTA technical consultants from Battelle Columbus Laboratories interviewed the following persons.

AGENCIES IN PLANNING OR CONSTRUCTION ACTIVITY

Atlanta—Metropolitan Atlanta Rapid Transit Authority (MARTA)

Al Locke, System Safety Engineer
John J. Tucker, Equipment Design Manager
Ernest Young, Equipment Design Engineer

Consultants

Parsons-Brinckerhoff-Tudor-Bechtel
Dale H. Fencken, Supervising Engineer, ATC

Baltimore—Mass Transit Administration (Maryland)

Walter J. Addison, Administrator
Carl Buhlman, Manager, Equipment and Equipment Systems
Frank W. Hearne, Director, Rapid Transit Development Division
Bernard Walker, Senior Electrical Engineer

Consultants

Daniel, Mann, Johnson, and Mendenhall/Kaiser Engineers
P. Morris Burgess, Chief Systems Engineer
David Hammond, Project Manager
Lewis Sanders, Senior Systems Engineer

Buffalo—Niagara Frontier Transportation Authority (NFTA)

Kenneth Knight, Manager of Metro Construction
Eugene Lepp, Manager of Systems

Denver—Regional Transit District (RTD)

Dr. J. Edward Anderson, Advisor
George Billman, Manager, Technology Assessment
Aubrey J. Butts, System Design
Carlos DeMoraes, Assistant Executive Director, Development
R. J. Farrell, Command and Control Specialist
Ralph Jackson, Director of Planning
Paul Newcomb, Director, System Design
John Simpson, Executive Director
A. J. Weaver, Subsystem Requirements
W. Wild

Consultants

Systems Management Contractor (TRW Systems et al.)
E. Bagerstos, Reliability/Safety
R. K. Boyd, Assistant Program Manager, Controls
A. F. Ems, Reliability/Safety
Robert Johnson/Simulation
Herman Wells, Controls

Miami—Metropolitan Dade County Transit Authority

E. Randolph Preston, Asst. Coordinator for Transportation Development

Consultants

Kaiser Engineers
James Allis
Ralph Mason
Eugene Stann, Project Manager

Minneapolis-St. Paul—Twin Cities Area Metropolitan Transit Commission

Camille Andre, Executive Director
John Jamieson, Director of Transit Development
Douglas Kelm, Chairman, Metropolitan Transit Commission
William Marshall, Systems Engineer
Robert Pearson, Project Manager, Fixed-Guideway Systems

Consultants

De Leuw Cather
Frank Smith, Small Vehicle Study

Others

Dr. J. Edward Anderson, University of Minnesota
J. Kiedrowski, Staff Member, Minnesota Senate Metropolitan Urban
Affairs Committee

Pittsburgh—Port Authority of Allegheny County (PAAC)

John Mauro, Executive Director
James Maloney, Acting Manager, Early Action Program
Robert Sedlock, Systems Technology

Consultants

Kaiser Engineers
Thomas R. Gibson, Systems Engineering
Zoltan Stacho, Project Manager

Washington, D.C.—Washington Metropolitan Area Transit Authority (WMATA)

C. David Allen, Systems Maintenance Engineer
Howard W. Lyon
David Q. Gaul, Assistant Director, Office of Equipment Design
Warren Quenstedt, Deputy General Manager
William Randolph
Ralph Sheldon, Train Control Engineer

Consultants

Gibbs and Hill
Joseph Smith, Senior Transportation Engineer
Jack Shepard, Chief Systems Engineer (Retired)

AUTOMATED AIRPORT SYSTEMS

Dallas-Fort Worth Airport—Dallas-Fort Worth Regional Airport Board (AIRTRANS)

Dennis Elliott, Manager of Engineering
Dalton Leftwich, Operations Supervisor, AIRTRANS
David Ochsner, Manager, AIRTRANS
David Slaboda, Maintenance Supervisor, AIRTRANS

Supplier

LTV
Richard Condrey, Manager, Ground Transportation
Austin Corbin, Project Manager
John Loutrel, Operations Research

Seattle-Tacoma International Airport—Port of Seattle (Sea-Tac)

Arthur Krause, Airport Maintenance Superintendent
Eugene Sagar, Operations Manager, Port of Seattle
Don Shay, Director of Aviation, Port of Seattle

Consultants

The Richardson Associates
Harry Linden, Assistant Administrative Director

Supplier

Westinghouse Electric Company
Joseph Borkowski, Maintenance Manager

SUPPLIERS

General Railway Signal Corp. (GRS), Rochester, N.Y.

Dr. John Freehafer, Manager of Advanced Engineering
Arthur Gebhardt, Vice President, Marketing
Mark Sluis, Vice President, Engineering

Westinghouse Air Brake Company (WABCO), Union Switch and Signal Division,
Swissvale, Pa.

Homer Hathaway, Senior Systems Consultant

Westinghouse Electric Company (WELCO) Transportation Division, Pittsburgh, Pa.

Philip Gillespie, Manager of Market Development

James H. King, Reliability Engineer

Dr. Robert Perry, Manager, Train Controls and Vehicle System Engineering

INSTITUTIONS

Amalgamated Transit Union, Washington, D.C.

Walter Bierwagen, Member, General Executive Board and Director of
Public Affairs

Earle Putnam, General Counsel

American Public Transit Association (APTA), Washington, D.C.

Robert Coultas, Deputy Executive Director

Jack Hargett, Legislative Liaison

B. R. Stokes, Executive Director

FEDERAL AGENCIES

Transportation Systems Center (TSC), Cambridge, Mass.

Robert Casey, Systems Analyst

Harry Hill, Man-Systems Technology

Robert Pawlak, Project Manager, ATC Program

Chan Watt, Systems Safety/Reliability/Maintainability

Urban Mass Transportation Administration (UMTA), Washington, D.C.

Steven Barsony, Acting Director, Morgantown Division, Office of R&D

Edward J. Boyle, Manager, Safety Division, Office of Transit Management

Ray Brunson, Systems Development Branch, Office of R&D

Vincent DeMarco, Systems Development Branch, Office of R&D

Duncan MacKinnon, Chief, Advanced Development Branch, Office of R&D

Paul Spencer, Staff Engineer, Rail Branch, Office of R&D

Federal Railroad Administration (FRA), Washington, D.C.

C. M. Bishop, Chief, Signals Branch, Standards and Procedures Division

Rolf Mowatt-Laarsen, Chief, Standards and Procedures Division, Bureau of Safety

William Paxton, Chief, Maintenance of Way Branch, Standards and Procedures Division

National Transportation Safety Board (NTSB), Washington, D.C.

J. Emerson Harris

Robert Jewell

Thomas Styles, Chief, Railroad Safety Division

BIOGRAPHIES OF URBAN MASS TRANSIT ADVISORY PANEL

George Krambles, Chairman
General Operations Manager
Chicago Transit Authority (CTA)
Chicago, Ill.

Mr. Krambles is responsible for the transportation, maintenance, and operations planning departments which together include more than 11,000 of CTA's 12,500 employees. Prior to assuming the position of General Operations Manager, he served as operating manager in charge of the transportation and shops and equipment departments from 1972 to 1973. He was superintendent of research and planning related to service and marketing from 1965 to 1972, and superintendent of operations for the transportation department from 1961 to 1965. In addition, he was named manager in 1964 for the 2-year Skokie Swift mass transportation demonstration grant project.

Mr. Krambles is a graduate of the University of Illinois and a registered professional engineer in Illinois. After a brief period with the Indiana Railroad, he joined the Chicago Rapid Transit Company, serving in the mechanical and electrical departments. His work during this period included maintenance and construction design as well as power system operation.

Walter J. Bierwagen
Vice President and Director of Public Affairs
Amalgamated Transit Union
AFL-CIO

Mr. Bierwagen has spent most of his professional life in a leadership role in organized labor. From 1951 to 1964, Mr. Bierwagen was president and business agent of the Washington local of the Amalgamated Transit Union representing Washington transit employees. In this role he was the primary officer who directed collective bargaining and legislative programs of interest to his union. Subsequently he became vice president of the international union, engaging in legislative representation before Congress on behalf of the members of the Amalgamated Transit Union, and conducting collective bargaining negotiations on behalf of many ATU local unions in the Eastern section of the United States. In addition he has been involved in State activities for the labor movement by serving as vice president of the Maryland State Federation, AFL-CIO, as well as a principal officer of the Washington Central Labor Council. His interests have gone beyond the labor movement, including active leadership in Group Health Association, and the development of transit health, welfare, and pension funds on the local level. As mentioned above, Mr. Bierwagen's principal activity has been in the legislative arena. In that role, he played an important part in the development of the Urban Mass Transportation Act of 1964 and its amendments, especially the requirements to protect employees, and in the development of similar legislation at the State level.

Robert A. Burco
Deputy Director
Oregon Department of Transportation
Salem, Oreg.

Mr. Burco has been active in the field of urban transportation policy research since 1967, performing studies for local and State governments and the Federal Government. Most recently he has headed his own consulting firm specializing in transportation and environment policy. Previously he was employed in a research capacity at the Stanford Research Institute and at Bell Telephone Laboratories. Mr. Burco received a B.S. and M.S. from Stanford University and a second master's degree from the University of California at Berkeley.

He has been involved professionally in the activities of the Transportation Research Board and has lectured widely on the subject of transportation. His clients have included a number of public interest groups, the California State Legislature, Office of the Mayor of Los Angeles, and the California Department of Transportation. He is familiar with transportation policy in Europe, Canada, and Japan, having worked on international assignments with the Organization for Economic Cooperation and Development in Paris. In September 1975, he joined the administration of Governor Straub as Deputy Director of the Oregon Department of Transportation.

Jeanne J. Fox
Associate Director, Research
Joint Center for Political Studies

Mrs. Fox has conducted research on transportation as a public policy issue since 1971. Prior to her present position, she was a consultant at Mark Battle Associates, and before that she was employed at the United States Information Agency.

She is a graduate of the University of Minnesota.

Mrs. Fox was the principal author of *Urban Transportation: Minority Mobility in the 70's (DC-RDG-12)*, prepared for UMTA, Civil Rights Division. She was one of two principal investigators and co authors for UMTA research which resulted in the following three reports:

Transportation for the Elderly and the Handicapped (DOT-UT-533), Marketing Techniques and the Mass Transit System (DOT-UT-533), Marketing Techniques and the Mass Transit System—A Handbook (DOT-UT-533).

She also wrote the "Public Transit in the Spotlight," *Focus*, 1974.

Lawrence A. Goldmuntz
President, Economics & Science Planning, Inc.
Washington, D.C.

Dr. Goldmuntz is a consultant and the present Visiting Professor of Engineering and Public Policy at Carnegie-Mellon University in Pittsburgh, Pa. Prior to his present positions, he worked in the Office of the Assistant Secretary of Transportation for Research and Technology and chaired the Metroliner Steering Committee, charged by the Secretary of Transportation to supervise the completion of the Northeast corridor Washington-New York high speed rail project. He also served as Executive Secretary of the Air Traffic Control Advisory Committee at DOT, as Assistant Director for Civilian Technology in the Office of Science and Technology of the Executive Office of the President, and as chairman of a committee for the Office of Science and Technology which reviewed the Cumulative Regulatory Effects on the Cost of Automotive Transportation (RECAT). Previously in private industry, he served as President of TRG Inc., a research and development organization involved in air traffic control and other electronic systems.

Dr. Goldmuntz is a graduate of Yale University where he received his B.E.E. (1947) and M.E.E. (1948) degrees and a Ph.D. (1950) in Applied Science.

Dorn C. McGrath, Jr.
Chairman, Department of Urban and Regional Planning
The George Washington University
Washington, D.C.

Professor McGrath has served as an advisor or consultant to a variety of agencies concerned with transportation and urban growth policy, including the House Committee on Public Works, the House Committee on Banking and Currency, the U.S. Commission on Population Growth and the American Future, the U.S. Aviation Advisory Commission, the Port of Oakland, and the North Central Texas Council of Governments. He is a member of the Environmental Studies Board of the National "Academy of Sciences and Chairman of the Environmental Advisory Board for the Chief of Army Engineers.

Professor McGrath is a graduate of Dartmouth College where he received his B.A. degree. He received his M.A. in City Planning from Harvard University.

He is a principal author of the National Academy of Sciences report, Jamaica Bay and Kennedy Airport, published in 1970, and has written numerous articles on transportation and related community development planning.

Bernard Oliver
Vice-President of Research and Member of the Board of Directors
Hewlett-Packard Company
Palo Alto, Calif.

Dr. Oliver previously worked on the development of automatic tracking radar, television transmission, information theory and efficient coding systems, as a member of the technical staff of the Bell Telephone Laboratory (New York) from 1940 to 1952. He joined Hewlett-Packard in 1952 as director of research and was appointed Vice-President of Research and Development in 1957. Presently, he is also a lecturer in electrical engineering at Stanford University and a member of the Science and Technology Advisory Committee to the California State Assembly. He recently served on a State senate panel investigating the safety aspects of the BART system.

Dr. Oliver is a 1935 graduate of Stanford University where he received his A.B. and M.S. degrees in electrical engineering. In 1940 he received his Ph.D. degree in electrical engineering from Cal Tech.

He is the author of numerous technical articles and holds over 50 U.S. patents in the field of electronics. He is a Fellow of the IRE and has served as vice president and later president of the IEEE.

Simon Reich
Supervising Engineer-Signals
Gibbs & Hill, Inc.
New York, New York

Mr. Reich took his present position in the Signals department, after serving in the Transportation and Systems departments of Gibbs & Hill. He has an extensive background in automatic train control (ATC). He has worked on the design of signaling and control systems and the technical coordination of the WMATA rail rapid transit system, including the ATC and communication functions. Prior to association with Gibbs & Hill, he was involved in the design of train control demonstration systems for the BART Concord test track, the CTA Lake Street Line, the CTS Airport Extension, and the MBTA South Shore Project-all while working for the General. Railway Signal Company. Other activities of Mr. Reich at GRS include the engineering for automatic train operation systems and train control research and development for rapid transit lines and railroads. These included projects on automatic train operation for the NYCTA 42d Street Shuttle, and a cab signaling system for the Netherlands State Railway, This work involved design of train-borne equipment and instrumentation to measure train performance.

Mr. Reich is a 1959 graduate of the Polytechnic Institute of Brooklyn where he also received a B.S. in Physics.

Frederick P. Salvucci
Secretary, Executive Office of Transportation and Construction
Commonwealth of Massachusetts
Boston, Mass.

Secretary Salvucci has been occupied, both professionally and personally, with the problems of urban planning and transportation in the Boston area since his formal training at the Massachusetts Institute of Technology. Prior to his appointment as Secretary, Mr. Salvucci held transportation and management jobs with the Boston municipal government and worked as a transportation planner for the Boston Redevelopment Authority,

Mr. Salvucci helped to organize and found Urban Planning Aid, an advocacy planning group established to provide technical and planning assistance to low-income and other community groups. He has also been active in the Greater Boston Committee on the Transportation Crisis, a public transportation advocacy group, the Massachusetts Air Pollution and Noise Abatement Committee, an organization concerned with promoting a shift from air to rail travel, and the East Boston Neighborhood Council,

Mr. Salvucci's formal training at M.I.T. concluded in 1962 with an M.S. in civil engineering. He was named Fulbright Scholar in the 1964-65 academic year.

Thomas Chapman Sutherland, Jr.
Assistant Dean, School of Architecture and Urban Planning
Princeton University
Princeton, N.J.

Dean Sutherland, prior to his present position, was Assistant Director, Office of Research and Project Administration at Princeton and before that, Assistant to the Chairman of Princeton's Department of Astrophysical Sciences. He has served as former Chairman of the South New Jersey Group of the Sierra Club, a Trustee of the Stony Brook-Millstone Watersheds Association, Vice Chairman of the Princeton Conservation Commission, and recently a member of the New Jersey Solid Waste Advisory Council. Dean Sutherland is presently Chairman of the University Environmental Advisory Committee and a member of the Gateway Citizens Committee.

He is a graduate of the United States Naval Academy. While in the Navy, he served in the submarine service and, as a staff member of the Navy's Office of Special Projects, worked on the development of the Polaris missile.

Dean Sutherland has authored numerous articles on conservation, ornithology, astronomy, and railroads. He is co author of the book, *The Way to Go: The Coming Revival of U.S. Rail Passenger Service* (Simon & Schuster), published in 1974. He is presently on the Board of Directors of the National Association of Railroad Passengers (NARP).

Stewart F. Taylor
Vice President & Director Mass Transportation
Sanders & Thomas, Inc.
Pottstown, Pa.

Mr. Taylor has been a consultant on transportation projects for public agencies at the Federal, State, and local level and for private corporations. Before becoming a consultant, he served with the former Pennsylvania Railroad in various staff and management positions. He was also Chairman of the 1975 National Conference on Light Rail Transit, jointly sponsored by the Urban Mass Transportation Administration, the National Research Council, the American Public Transit Association, and the University of Pennsylvania.

Mr. Taylor is a graduate of Yale University and Harvard Law School. He has authored numerous articles and papers on transportation. The most recent is entitled, "Urban Transportation—Another Alternative," published by the Heritage Foundation of Washington, D.C. His work has appeared, on several occasions, in the United States Congressional Record.

Appendix H

REFERENCES

- American Transit Association, "Vandalism and Passenger Security," September 1973.
- Association of American Railroads, Signal Section, American Railway Signaling Principles and Practices, Chapter 1: History and Development of Railway Signaling, Chicago, Ill., 1954.
- Air Transport World, "Facts and Figures," Vol. 12, No. 1, January 1975.
- Battelle Columbus Laboratories, Safety in Urban Mass Transportation, Report No. UMTA RI-06-0005-75-1, prepared for Urban Mass Transportation Administration, Washington, D. C., April **1975**,
- Department of Transportation, Transportation Systems Center, Safety and Automatic Train Control for Rail Rapid Transit Systems, Report No. DOT-TSC-OST-74-4, prepared for the Office of the Secretary, Washington, D. C., July **1974**,
- Grose, V. L., "Constraints on Application of Systems Methodology to Socio-Economic Needs," presented to First Western Space Congress, Santa Maria, Calif., October **1970**.
- Highway Research Board, Task Force on Urban Mass Transportation Safety Standards, Safety in Urban Mass Transportation: the State of the Art, for the National Research Council, Washington, D. C., September 1973.
- Institute for Rapid Transit, Moving People Safely: Safety Guidelines for Urban Rapid Transit Systems, Washington, D. C., January 1974 (2d ed.).
- King, J. H., "Making Transit Reliability a Reality," Westinghouse Transway News, October 1975.
- MITRE Corp., Research Requirements of the Rapid *Rail* Industry, Report No. UMTA-TRD-90-71, prepared for Urban Mass Transportation Administration, Washington, D. C., June 1971. (PB 204 438)
- National Transportation Safety Board, Special Study of Rail Rapid Transit Safety, Report No. NTSB-RSS-71-1, Washington, D. C., June 1971.
- National Transportation Safety Board, Safety Methodology in Rail Rapid Transit System Development t, Report No. NTSB-RSS-73-1, Washington, D. C., August 1973.
- Reistrup, P., President of the National Railroad Passenger Corporation (Amtrak), Statement before the Subcommittee on Transportation of the Committee on Appropriations, United States Senate, April 7, 1975.
- Transit Development Corporation, Safety Priorities in Rail Rapid Transit, Report No. UMTA-DC-06-0091-75-1, prepared for Urban Mass Transportation Administration, Washington, D.C., March 1975 (2 Vols.),
- United States Congress, Urban Mass Transportation Act of **1964**, P.L. 88-365, 78 Stat. 302. (49 U.S.C. 1601).
- United States Congress, Department of Transportation Act (October **15, 1966**), P.L. 89-670, 80 Stat. 931 (49 U.S.C. 1653).
- United States Congress, Federal Railroad Safety Act of 1970, P.L. 91-458, 84 Stat. 791 (45 U.S.C. 421).
- United States Congress, National Mass Transportation Assistance Act of 1974, P.L. 93-503, Stat. 1565 (49 U.S.C. 1601).

CONGRESSIONAL LETTERS OF REQUEST

UNITED STATES SENATE,
COMMITTEE ON APPROPRIATIONS,
Washington, D. C., February 25, 1974.

Hon. EDWARD M. KENNEDY,
Chairman, Technology Assessment Board,
House Annex, Washington, D.C.

DEAR MR. CHAIRMAN: On behalf of Senator Robert C. Byrd, Chairman of the Transportation Subcommittee, and Senator Clifford P. Case, the Subcommittee's Ranking Minority Member, I am transmitting the attached technology assessment request to you.

With kindest personal regards, I am
Sincerely,

JOHN L. McCLELLAN, Chairman.

Enclosure.

UNITED STATES SENATE,
Washington, D. C., February 6, 1974.

Hon. JOHN L. McCLELLAN,
Chairman, Senate Appropriations **Committee**, **New Senate** Office Building,
Washington, D.C.

DEAR MR. CHAIRMAN: We would like to enlist your support for a prompt and thorough study of automation in federally supported urban rail transit projects.

This matter of increasing concern to our Subcommittee arises because several large cities, including Baltimore and Atlanta, are planning automated train systems and are or will be seeking substantial federal funding within the next two years.

At the same time, serious questions have arisen as to whether and to what degree Automated Train Control (ATC) should be used in rail transit.

The recent experience with San Francisco's new rail system, known as BART, has helped focus attention on this problem.

Original plans for BART called for a fully automated system requiring no on-board train operator. This has not worked out because of a series of malfunctions in the ATC system. Costly patch-up work, with substantial federal help, is underway, but complete automation of BART now appears out of the question.

In light of the BART experience we should be alert to see to it that the same expensive mistakes are not made in other federally supported urban rail transit projects involving Automated Train Control.

At present, there is no means of assuring that the mistakes made in the BART project will not be repeated.

A draft study just completed by the Department of Transportation's Transportation Systems Center states that train control "typically receives little priority and emphasis" even though—as the study emphasizes—this choice of system greatly affects revenue, safety, including, we add, the serious matter of crime prevention, and operation and maintenance costs. The DOT study did not purport to deal with cost and cost savings in detail, but it did state that there seemed to be an "intuitive conclusion that an automated system should be more economical than a man-operated system in achieving or surpassing a given level of service or safety."

The Congress and this Committee should not accept an "intuitive" judgment on matters of such cost and complexity.

There are at least two questions that require particular study: (1) to what extent should urban rail transit systems be automated? and (2) how should these projects be planned and executed?

The appropriate body to carry out such an independent, in-depth study for this Committee is Congress' Office of Technology Assessment. Under the provisions of the "Technology Assessment Act of 1972" (P.L. 92-482, Sec. 3(d), (1)), we ask that you transmit to the Chairman of the Technology Assessment Board our request for a study that would:

1. Assess the state of automated train control technology and its application to existing and planned rail transit systems.—What major research is underway and what is its objective? What train control systems are being considered for transit projects now in the planning stage? What are the characteristics of these systems and how are they similar to or different than those of BART and other highly automated systems in use?

2. Assess the testing methods by which the workability of automated train projects is determined.—To what extent are prototypes built and tested? What has been the lesson of BART and other recent projects concerning the necessity for system testing during development? What provisions have been made for the testing of train control systems now being planned?

3. Assess the process by which new rail transit systems or extensions of existing systems are planned and executed; evaluate the adequacy and professionalism of cost, safety, including crime prevention, and other analyses used.—What criteria are used, particularly in determining degree of automation? To what extent are economic tradeoffs (i.e., cost of partially manual vs. fully automated system) explicitly considered? How and to what extent is public oversight maintained throughout the project? What federal requirements, if any, apply to these federally assisted projects?

Your assistance in transmitting this request will be appreciated,

Sincerely,

ROBERT C. BYRD,

Chairman, Transportation Appropriations Subcommittee.

CLIFFORD P. CASE,

Ranking Minority Member,
Transportation Appropriations Subcommittee.