

Industrial Energy Use

June 1983

NTIS order #PB83-240606

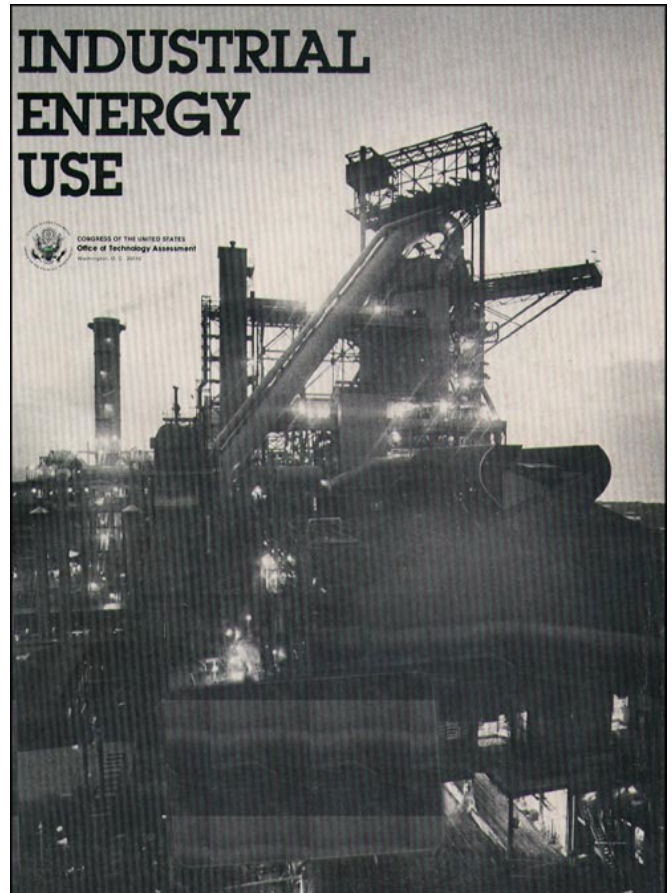

Recommended Citation:

Industry / Energy Use (Washington, D. C.: U.S. Congress, Office of Technology Assessment, OTA-E-198, June 1983).

Library of Congress Catalog Card Number 83-600547

For sale by the Superintendent of Documents,
U.S. Government Printing Office, Washington, D.C. 20402

Foreword

This report responds to a request by the Senate Committee on Finance and the House Committee on Energy and Commerce for an analysis of the prospects for energy efficiency in the U.S. industrial sector, the technologies available to improve industrial energy efficiency, and the effect of various legislative policies on stimulating increased efficiency. This report complements several recent OTA reports on energy efficiency: *Residential Energy Conservation*, *Energy Efficiency of Buildings in Cities*, and *Industrial and Commercial Cogeneration*.

OTA examined energy use in the industrial sector in general and in the largest energy-using industries—pulp and paper, petroleum refining, chemicals, and steel—in detail. The report identifies the major technical opportunities available to each industry to improve energy efficiency, the barriers to implementation of such technologies, and the factors that guide corporate decisions about energy efficiency-improving investments. The policy options chosen for assessment were the effects of: 1) the accelerated cost recovery system of the 1981 Economic Recovery Tax Act, 2) investment tax credits for energy-conserving capital expenditures, 3) a tax on petroleum and natural gas, and 4) increased capital availability through lower interest rates.

In the course of this assessment, OTA drew on the experience of many organizations and individuals. In particular, we appreciate the generous assistance of our distinguished advisory panel and workshop participants, as well as the efforts of the project's consultants and contractors. We would also like to acknowledge the help of the numerous reviewers who gave their time to ensure the accuracy and comprehensiveness of this report. To all of the above goes the gratitude of OTA, and the personal thanks of the project staff.



JOHN H. GIBBONS
Director

Industrial Energy Use Advisory Panel

Herbert Fufeld, *Chairman*
New York University

E. Milton Bevington
Servidyne, Inc.

Gordon Geiger*
Inland Steel Co.

Rudolph Penner
American Enterprise Institute

Harold Bogart
Independent Consultant

J. M. Leathers
Dow Chemical Co.

R. B. Pool
Kaiser Aluminum & Chemicals Corp.

Carleton Burt
Equitable Life Assurance of the U.S.

Harvey Morris
Harvey Morris Associates

Rosalie Wolf
International Paper Co.

William Chandler
Environmental Policy Institute

John Myers
Southern Illinois University

William Cunningham
AFL-CIO

Henry Page, Jr.
Sun Refining & Marketing Co.

•Now at North Star Steel

Workshop on the Pulp and Paper Industry

William Adams
Accuray Corp.

George Hatsopoulos
Thermo Electron Corp.

Alfred Nissan
Westvaco (retired)

Edmond Perreault
Champion International Co.

Howard Harding
Thermo Electron Corp.

Richard Ludwig
Hammermill Paper Co.

George Boyd III
Kidder Peabody & Co.

Ronald Slinn
American Paper Institute

Workshop on the Petroleum Refining Industry

Van Boyette
*National Petroleum Refining
Association*

R. L. Jones
American Petroleum Institute

A. L. Modiano
American Petroleum Institute

Sherwood Breaux
Cities Service Co.

David Michael
Mobil Oil Corp.

David Story
Gulf Research & Development Co.

Workshop on the Chemicals Industry

A. C. Benjamin
E. I. du Pont de Nemours & Co., Inc.

Byron Brown, Jr.
E. I. du Pont de Nemours & Co., Inc.

Daniel Steinmeyer
Monsanto Co.

James Borden
E. I. du Pont de Nemours & Co., Inc.

L. M. Magner
E. I. du Pont de Nemours & Co., Inc.

Robert Yates
Uniroyal Chemical

Workshop on the Steel Industry

Donald Barnett*
American Iron and Steel Institute

James Hamilton
U.S. Steel Corp.

Gary Myers
Armco Steel

Frederick Corban
Inland Steel Co.

Gerald Houck
American Iron and Steel Institute

Louis Schorsch* *
American Iron and Steel Institute

Robert Crandall
Brookings Institution

Jack Kiefer
Cameron Iron Works, Inc.

Joseph Wyman
Shearson/American Express

George Ferris
Independent Consultant

Joseph Kotelchuck
United Steelworkers of America

James Gay
North Star Steel

Roy Leidner
Bethlehem Steel

*Now at World Bank.

* *Now at Congressional Budget Office.

OTA Industrial Energy Use Project Staff

Lionel S. Johns, *Assistant Director, OTA
Energy, Materials, and International Security Division*

Richard E. Rowberg, *Energy and Materials Program Manager*

James F. Ryan, *Project Director*

Eric Bazques Alan Crane Allan Hoffman*
Joanne Seder Thomas Sheahan** Richard Thoreson

Administrative Staff

Virginia Chick Lillian Quigg Edna Saunders

Other Contributors

Bernard Gelb, Congressional Research Service: general industrial sector analysis
Robert Howell, Independent consultant: petroleum refining industry
Harvey Morris, Harvey Morris & Associates: generic technologies and pulp and paper industry
George St. Pierre, Ohio State University: steel industry
Kathryn White, Independent consultant: editor

Contractors and Consultants

Roy F. Weston, Inc., Philadelphia, Pa.
The Pace Co. Consultants & Engineers, Inc., Houston, Tex.
Energy and Environmental Analysis, Arlington, Va.
Technology & Economics, Cambridge, Mass.
Steven Carhart Associates, Washington, D.C.
Barry Richmond, Dartmouth College, Hanover, N. H.
Christian Kampmann, Dartmouth College, Hanover, N. H.
Marc Ross, University of Michigan, Ann Arbor, Mich.
Energy Productivity Center, Mellon Institute, Arlington, Va.

OTA Publishing Staff

John C. Holmes, *Publishing Officer*

John Bergling Kathie S. Boss Debra M. Datcher
Joe Henson Linda Leahy Donna Young

* Now at the National Academy of Sciences, Washington, D.C

* * Now at Stanford Research Institute, Washington, D.C.

Contents

| <i>Chapter</i> | <i>Page</i> |
|----------------------------------------------------------------------------|-------------|
| Overview | ix |
| 1, Summary and Findings. | 3 |
| 2.The Industrial Sector: Growth, Trends, and Investment Behavior | 21 |
| 3. Industrial Energy: Uses, Technologies, and Policies | 37 |
| 4.The Pulp and Paper Industry | 65 |
| 5.The Petroleum Refining Industry. | 85 |
| 6.The Chemicals Industry | 115 |
| 7.The Steel Industry. | 139 |
| Appendix A: The Industrial Sector Technology Use Model | 165 |

Overview

For many years to come, energy need not be a constraint to economic growth in the United States. OTA projects that in the next two decades investments in new processes, changes in product mix, and technological innovation can lead to improved industrial productivity and energy efficiency. As a result, the rate of industrial production can grow three times faster than the rate of energy use needed for that production.

Because the investments needed to improve energy efficiency are long term, a reduction in energy use growth rates resulting from investments begun now will continue through the 1980's and 1990's. Furthermore, this improvement will continue beyond 2000 as the proportion of new, energy-efficient capital stock increases. Improvements in energy efficiency for the next several years will be largely a result of housekeeping measures and investments that began during the 1970's.

In 1981, the industrial sector used 23 Quads* of direct fuel, electricity,** and fossil fuel feedstock, of which petroleum and natural gas constituted 73 percent. Four industries—paper, petroleum refining, chemicals, and steel—accounted for almost half of all industrial energy used. Over the past decade, soaring energy prices have led to significant changes in the absolute amount and mix of energy used in industry. Energy used per unit of product in the industrial sector decreased by almost 20 percent. This improvement was accomplished by housekeeping measures, equipment retrofits, and new process technologies that produce existing products and new product lines.

In addition to reducing the energy use growth rate, industry will continue its shift away from premium fuel use. For the next two decades, industrial coal use—particularly in boilers and in some large, direct heat units—will increase substantially because coal is cheaper than oil and natural gas. Moreover, the demand for purchased electricity will probably grow faster than the total industrial energy demand if the price difference between natural gas and electricity continues to decrease.

While industry has made significant strides in reducing energy use, **opportunities for further gains in energy efficiency from technical innovation are substantial.** Because capital stock has not turned over as quickly in recent years as it did in the 1960's, there is a large backlog of retrofit improvements to be made. Furthermore, high capital costs and the limited capital pool have kept many new process technologies from penetrating product markets. **OTA projects that new processes or process technologies would save more energy than would retrofits and housekeeping measures, and would reduce overall costs by improving productivity and product quality. However, such process shifts will entail large capital outlays, which in turn, will require general economic growth over many years.** Without economic growth, there will not be enough product demand or capital to support these productivity improvements.

A product mix shift away from energy-intensive products will also continue to contribute to the decline in energy use growth rates. Product mix shift will occur within specific industries (e.g., a shift from basic chemical production to agricultural/specialty chemical manufacture) as well as from one industry to another (e.g., a shift away from steel to aluminum and plastics in auto manufacture). These shifts are driven by

*A Quad equals 1 quadrillion (10^{15}) Btu.

**This is final demand, so that electricity is accounted for at 3,412 Btu/kWh

changing demand patterns and international competition, as well as by increasing energy prices.

OTA found that corporations have a strategic planning process that evaluates and ranks investments according to a variety of factors: product demand, competition, cost of capital, cost of labor, energy and materials, and Government policy. In analyzing energy-related investment behavior, **OTA found no case in which a company accorded energy projects independent status.** Although energy costs are high in each of the four industries examined by OTA, costs of labor, materials, and capital financing are also high. **Thus, energy-related projects are only part of a general strategy to improve profitability and enhance a corporation's competitive position.**

Most firms regard energy efficiency as one more item in which to invest and not as a series of projects that are different from other potential investments. This view differs significantly from the view of firms that produce energy or energy-generating equipment where the **entire investment** is focused on increasing energy production. This difference has important policy implications because incentives aimed at reducing energy demand growth must compete with other strategic factors and are therefore diluted. Energy incentives directed at increasing energy supply suffer no such competition.

Of the four most energy-intensive industries, chemicals and paper will show the largest growth in production over the next two decades and will also show a substantial increase in energy efficiency. In the paper industry, energy use has risen slightly since 1972, but the industry is now more energy self-sufficient. In 1981 the paper industry generated half of all its energy needs through the use of wood residues as fuel. By 2000 self-generation of energy could result in the paper industry meeting over 60 percent of its needs internally. The limitation on the percentage of self-sufficiency is the value of the product foregone by using feedstock (wood) as fuel. Also, the paper industry's use of oil will decline as residual oil is displaced in boilers by coal and biomass fuels, OTA projects that over the next two decades, energy use per ton of paper will decline, owing to specific process changes in papermaking steps, such as oxygen-based bleaching, computerized process controls, and new methods of making paper.

The petroleum refining industry will show a decline in overall product output but will continue to improve its energy efficiency, although only slightly. Energy efficiency gains from retrofit and housekeeping measures will be merely offset by a shift to heavier, high-sulfur, crude oil feedstocks and by increased use of energy in refining because of market requirements for high-octane, unleaded motor fuels. Of the four industries, this is the only one in which product or process shifts are not projected to lead to less energy use. Nonetheless, overall efficiency can be expected to improve as a result of a number of anticipated technological changes in refinery operations, such as the extensive use of vapor recompression and waste heat boilers in the distillation and cracking processes and the use of computerized process controllers to optimize plant operations.

In the chemicals industry, energy efficiency improvements will result from a combination of retrofits to existing processes and technical innovation in new processes and products. For example, vapor recompression, process controls, and heat recuperators and exchangers will be added to existing processes to improve thermal efficiencies. In addition, there is a trend toward increased use of electricity and away from premium fossil fuels, especially natural gas. OTA projects that by 2000, coal use will account for almost one-third of the fuel used in the chemicals industry. An important source of energy efficiency improvement in the chemicals industry is a shift in product mix. Because of higher profit margins and less foreign competition, the in-

dustry will increase production of less energy-intensive, higher value chemicals, such as pharmaceuticals and pesticides, relative to more energy-intensive chemicals such as ethylene and ammonia.

As the steel industry retools to meet foreign competition, there will be a large reduction in energy intensity. The major source of this decline will be investments in new processes—i.e., 1) the replacement of ingot casting by continuous casting, and 2) the substitution of electric arc furnace or mini mills for the blast furnace/basic oxygen furnace combination. With continuous casting, significant energy will be saved by not having to reheat cooled metal ingots before shaping. Electric arc minimills will save energy by substituting scrap metal feedstocks for iron ore, thus reducing coke demand. This trend will also result in the substitution of steam coal for metallurgical coal since the former will most often be used to generate electricity,

Over the years, Congress has passed a number of measures that affect the industrial use of energy. In general, the goals of these measures have been to reduce oil imports, encourage domestic production of fossil fuels, and reduce energy demand through efficiency improvements. **OTA found that legislation directed specifically at improving energy efficiency in industry has little influence on investment decisions.** At the highest levels of corporate financial decision making, there is an awareness of Government tax and industrial policies. However, OTA found that technical decisions and energy project evaluation tend to be separate from and subservient to corporate financial decisions. Moreover, the decision to invest depends not only on an individual project's return on investment, but also on such corporatwide parameters as debt-equity ratio, debt service load and bond rating, and, most importantly, the aforementioned strategic considerations of corporate decision making. **Because energy must compete with other factors of production when investment choices are made, policy incentives directed at energy demand alone will be just one of a number of considerations in making these choices.** Unless such incentives are substantial, they are unlikely to alter a decision that would have been made in the absence of such incentives.

To assess the effects of a range of incentives on energy use in industry, OTA selected a set of policy initiatives directed at energy specifically or at corporate investment in general. The latter include the accelerated cost recovery **system (ACRS) provisions of the Economic Recovery Tax Act of 1981 (ERTA)** and increased capital availability for investment, while the former include broadened and expanded tax credits for energy investments and the imposition of energy taxes on premium fuels. These policies are compared to a reference case consisting of current economic conditions and the tax code as amended by ERTA.

The effect of the ACRS on increasing energy efficiency depends on the ability of the ACRS to increase investment. **OTA found that the ACRS is a positive stimulus to investment when the industry is profitable and growing.** Under these conditions, total investment and energy efficiency improvements would be accelerated by the ACRS. **As long as conditions of high interest rates, low-to-moderate demand growth, and the like exist, however, the ACRS will do little to increase energy efficiency.**

Energy investment tax credits at a 10-percent level have little direct influence on capital allocation decisions in large American firms, and thus have little or no influence on energy conservation. These tax credits appear to be too small to exert any change in the return on investment of a company when the only factor they affect is energy. **However, energy investment tax credits directed at energy production, such as cogeneration by third parties, would be effective.** In this case, the entire investment would be covered by the tax credit, and energy would be the principal product being produced by the investment. Regarding investments in technologies that improve

the energy efficiency of industrial process technologies, however, OTA could find no case where decisions to undertake a project depended on gaining a 10-percent energy investment tax credit.

Taxes at a rate of \$1 per million Btu on premium fuels—natural gas and petroleum—would change the fuel mix and cause energy efficiency to improve, although not by more than a few percent. Because of the already large cost differential between premium fuels and coal, the increase in costs as a result of the tax would not significantly change the economic incentive to switch to coal. The effect of the tax would be more significant for electricity, but there the availability of industrial production technologies that use electricity instead of petroleum or natural gas would be the limiting factor. Consequently, imposition of the tax would cause only a slight increase in conversion to coal and electricity from natural gas and petroleum. Investments in energy efficiency through retrofits and new process technology would still primarily be limited by capital availability and growth in product demand.

The fuel tax would have different consequences for each of the energy-intensive industries investigated. OTA found that a premium fuels tax would accelerate energy self-sufficiency and decrease natural gas consumption in the paper industry. The petroleum refining industry might be affected by a premium fuels tax in two ways: 1) some energy-related projects would be given a higher priority, and 2) earnings would decline because of a general decrease in product demand. In the chemicals industry, the domestic impact of a premium fuels tax is potentially detrimental. The greatest impact would likely be on the ability of the industry to export products as well as to make the domestic market more vulnerable to imports. Finally, a premium fuels tax would be least detrimental to the steel industry because only a small percentage of the industry's energy is derived from petroleum sources.

The best way to improve energy efficiency is to promote general corporate investment by reducing the cost of capital. Corporations that believe energy prices will continue to rise have a strong impetus to use capital for more energy-efficient equipment. Low interest rates affect energy efficiency to the extent that lower rates may allow a company's cash flow to go further, its debt service to be less burdensome, or its ability to take on more debt to increase. Lowering interest rates would increase capital availability and therefore allow more projects to be undertaken. Improvement in capital availability would magnify the effect of the ACRS because the ability to make use of the latter depends on the investment climate. **At the same time, however, it should be recognized that growth in product demand is essential if investment is to take place, even with lower interest rates.**



Chapter 1

Summary and Findings

Photo credit: Sun Oil Co.

Contents

| | |
|----------------------------------------------------------|----|
| U.S. Industrial Energy Use.....** .. , **.....) | 5 |
| Energy Conservation | 8 |
| Investment Considerations | 9 |
| Case-Study Industries | 13 |
| Policy Options | 18 |
| Effects of Policy Options on the Industrial Sector | |

TABLES

| | |
|-----------------------------------------------------------------------|-------------|
| <i>Table No.</i> | <i>Page</i> |
| 1. Categories of Energy-Related Capital Investment.....* , * | 7 |
| 2. Average Industrial Fuel Prices Assumed in OTA Modeling..... | 7 |
| 3. Relative Energy/Output Growth Patterns for Years 1980-2000 ..,*..* | 7 |

FIGURES

| | |
|-------------------------------------------------------------------|-------------|
| <i>Figure No.</i> | <i>Page</i> |
| 1. Industrial Energy Demand, 1950-2000 | 5 |
| 2. Energy Intensity Projections, 1970-2000 | 10 |
| 3. Industrial Sector Energy Intensity Projection, 1972-2000 | 13 |
| 4. Industrial Sector Projections | 14 |

Chapter 1

Summary and Findings

Virtually every function of industry uses energy. Efficient use of this energy is affected by, among other things, available technology, capital investment, and the cost of energy. Since 1973, the cost of premium fuels such as petroleum distillates and natural gas has increased over a factor of three in real terms. In response, the industrial sector has taken numerous steps to reduce its energy use per unit of output. However, many opportunities still exist to use energy even more efficiently. OTA examined those opportunities to determine why they were not being exploited and to see if legislative policies could encourage faster improvements.

The OTA study focused on the four industries that use the most energy: paper, petroleum refining, chemicals, and steel. These industries were examined in detail for three reasons. First, it was assumed that if conservation and the more efficient use of energy had any role to play in U.S. manufacturing, it would be most apparent in these four industries. In 1981, these industries used nearly 10 quadrillion Btu (Quads) of final energy* (about 43 percent of all energy used by the industrial sector). Thus, these industries are likely to be the leaders in increasing energy efficiency.

Second, to the extent public policies have an effect on energy use, that effect should be greatest and most apparent where energy use is greatest. Such policies could result from a desire to reduce oil imports, to forestall depletion of domestic supplies of energy resources, and, perhaps most importantly, to improve the Nation's overall economic health.

Finally, by examining the operations and decisions of these industries and their constituent

firms, it should be possible to evaluate progress in energy conservation and the impacts of legislation as they would most likely occur. Each of these four industries explicitly considers energy in management activities and investment planning because energy use accounts for a significant share of each industry's production costs.

OTA examined the technical options available to each industry and the factors that guide investment decisions about energy efficiency improvements. A principal part of the analysis was a series of case studies of both large and small companies in each of the four industries. In addition, a series of engineering consultants knowledgeable about industry and its operations were asked to make independent appraisals of each industry and case-study firm. At workshops, industry representatives, consultants, OTA staff, and others integrated the results.

For the report, OTA identified the technical and economic potential for energy conservation and also for switching from high-cost and insecure premium fuels to lower cost domestic fuels in each industry. Both changes were seen to improve energy efficiency because they decrease the cost of energy per dollar of production. As a necessary part of its analysis, OTA examined the manner in which capital budgeting decisions about energy efficiency-improving projects were made. **OTA** also examined and identified the barriers that prevent efficient use of energy and assessed the likely effects on each industry of a selected list of Government policy initiatives on energy use and capital funding. The policies included the accelerated depreciation provisions of the 1981 Economic Recovery Tax Act, broadened and expanded tax credits for energy investments, imposition of energy taxes on premium fuels or equivalent price increases, and increased capital available for investment.

● This number values electricity at 3,412 Btu/kWh. It is final demand

U.S. INDUSTRIAL ENERGY USE

In 1981, U.S. industry used over 23 Quads* of energy-bearing materials, mostly as fuel, but also, in some cases, as feedstock. ** Manufacturing accounted for about 75 percent of that total; mining accounted for another 12 percent; and agriculture and construction, another 6 percent. The four manufacturing industries studied in depth by OTA accounted for about 57 percent of the total energy used in manufacturing, including 74 percent of the oil and 60 percent of the natural gas.

Between 1972 and 1981, American industrial energy use declined by over 2 Quads, and energy efficiency improved by almost 18 percent per unit of production. Even more noteworthy than the drop in absolute energy consumption was the decline in the rate of energy use compared to the rate from the previous decade. If growth rates of that decade had continued, industrial energy use would have reached nearly 40 Quads by 1981.

While this decline might initially be considered purely a gain in energy efficiency, analysis carried out by the Department of Energy (DOE) suggests that it is the result of a more complex process in which a changing product slate and a general decline in the growth of manufacturing output over the 1970's combined with energy efficiency to reduce overall energy use.

Industrial energy efficiency gains between 1972 and 1981 are notable in that they have occurred at the same time the rate of economic expansion declined. Given that capital has been severely restrained because of high interest rates and depressed sales, management has been less able to purchase new fuel-efficient capital stock than it could have if the economy were expanding at 1960-72 rates.

Domestic energy prices have greatly increased (in real dollars) over the past decade, leading to significant changes, both in the absolute amount

*Quadrillion Btu. This is final demand, for which electricity use is computed at 3,412 Btu/kWh. It includes petroleum products, natural gas, coal, and nonpurchased fuels such as biomass. Including conversion losses in producing the electricity, industry can be said to have used over 29 Quads of primary energy.

**Feedstocks are raw materials, natural or manmade, used in production,

of energy and in the mix of energy used in industry. Prices for distillate petroleum products have more than tripled over the past 12 years, while the cost of natural gas has risen by nearly four times. The overall average price of energy has increased from \$1.86 to \$3.69 (in 1972 dollars) per million Btu.

The change in the amount and mix of energy used by the industrial sector is shown in figure 1. Use of petroleum products increased from a 1951 level of under 5 Quads to a 1979 high of 10.3 Quads. It has since declined to almost 1970 levels. The use of coal has declined from a 1951 level of over 6 Quads to a 1981 level of 3.2 Quads. Natural gas use is down by over 1.0 Quad since 1971, while electricity use has increased by 1 Quad.

In the pulp and paper industry, total energy use has risen slightly since 1972. However, the industry is more energy self-sufficient, and energy use from purchased fuels has declined. The integrated mills that convert trees to pulp and then to paper are almost 25 percent more efficient now compared to 1972. Mills that convert purchased pulp to paper are almost 20 percent more efficient. Much of this energy efficiency has shown up in decreased use of residual fuel oil* (down 40 percent since 1972). Overall, the paper industry has exceeded its voluntary goal of 20-percent improvement by almost 5 percentage points.

The petroleum refining industry has decreased its overall energy use per unit of output by 20.8 percent, primarily by reductions in natural gas use (down 37 percent since 1972) and distillate and residual fuel oil use (down 62 percent and 31 percent, respectively). Based on 1972 production levels, the industry exceeded its voluntary goal of a 20-percent energy savings.

In the chemicals industry, energy use per unit of output has decreased by 24.2 percent since 1972 through decreased use of natural gas (down 24 percent) and residual fuel oil (down 42 per-

* Residual fuel oil is the heavy hydrocarbon material remaining after crude 011 is distilled; distillate fuel oil is the lightweight hydrocarbon material derived from crude 011 via distillation.

Figure I.—Industrial Energy Demand, 1950-2000

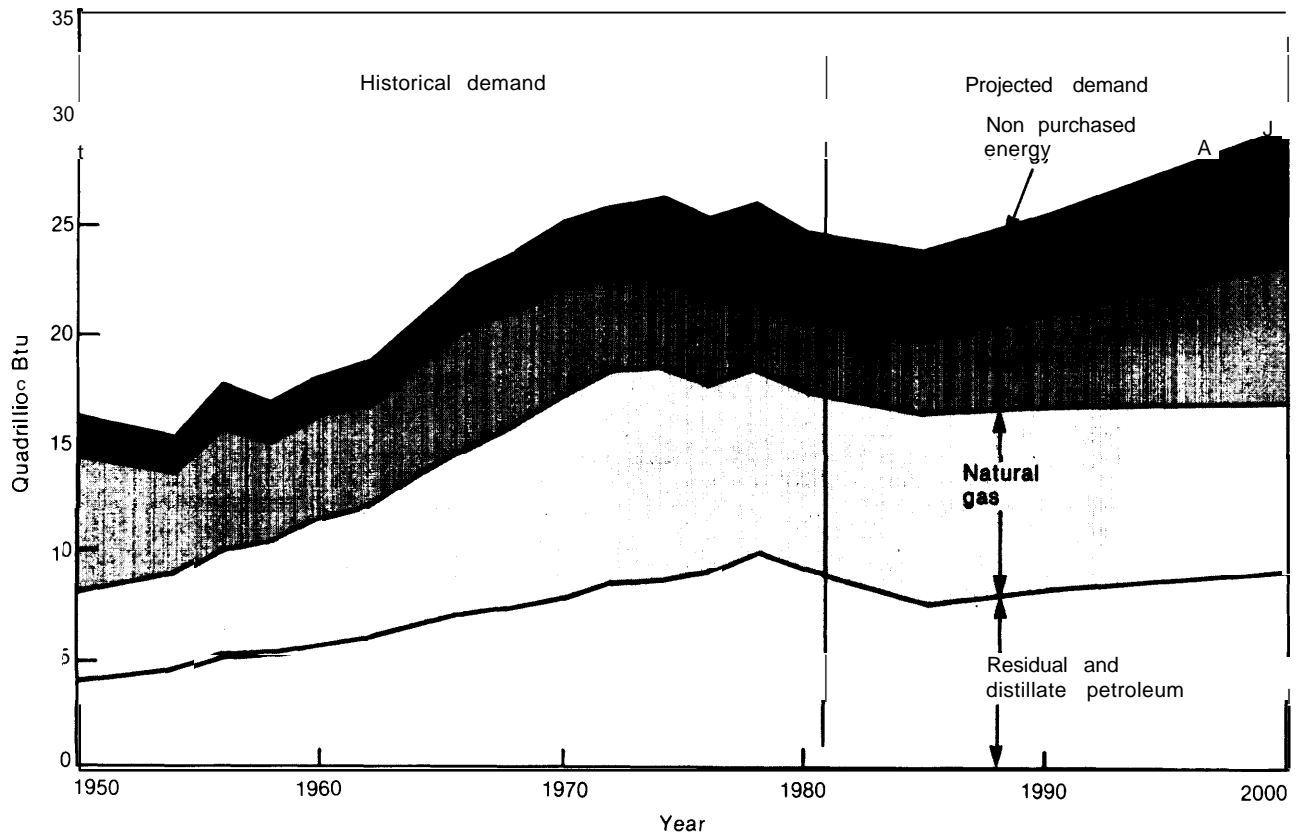

SOURCE: Energy Information Administration and Office of Technology Assessment.

cent). Compared to 1972 production levels, the industry exceeded its 1980 industry improvement goal by more than 10 percentage points.

The steel industry has decreased its use of energy per unit of output by 17 percent, mostly

through decreased use of bituminous coal (down 35 percent) and metallurgical coke (down 36 percent).

ENERGY CONSERVATION

Energy efficiency improvements can be classified into four categories: 1) improved housekeeping; 2) equipment retrofit; **3)** shifts to new process technologies (usually as a result of capacity expansion) to make existing products; and 4) shifts to new, less energy-intensive, product lines (see table 1). By and large, investments in (1) and (2) involve relatively small commitments of capital, whereas more is required of **(3)** and (4). OTA finds that housekeeping procedures, by

and large, have been or are being done. Managers in energy-intensive American corporations seem keenly aware of the cost of energy and therefore of the need to minimize its use. Housekeeping is one way to accomplish this task rapidly and inexpensively. Retrofits to existing equipment, however, are not as common. Given the existing economic environment—with high interest rates, depressed capacity utilization, and, in some cases, declining sales—retrofit additions

Table 1.—Categories of Energy-Related Capital Investment

| Definition | cost | Payback period | Example |
|----------------------------------------------------------------------------------------|------------------------|-------------------------|---------------------------------------------------------------------------------------------------------------------------------------------------------------------------|
| Housekeeping | | | |
| Substitution of labor and management effects for energy | Very low | Very short | Setting up routine procedures to check, clean, or replace steam traps; manually adjusting and optimizing boiler controls, monitoring building for air leaks, and the like |
| Equipment retrofit | | | |
| Addition of new parts; substitution of existing parts on functioning capital equipment | Usually moderate | Months to several years | Installation of computerized boiler control for maintenance of optimum burner efficiency; installation on process stream lines of additional heat exchanger surface |
| Process shift | | | |
| Building of new facilities to manufacture existing products with new processes | Often quite high | Many years | Building new minimill for production of steel from scrap metal; manufacture of linear low-density polyethylene at low pressure using new catalytic system |
| Product switching | | | |
| Undertaking the production of a new series of products | Moderate to quite high | One to many years | Switching from production of bulk commodity chemicals to that of biotechnology chemicals |

SOURCE: Office of Technology Assessment

are often perceived as strategically unjustified. OTA has found that most retrofits have very short payback periods; i.e., the projects pay for themselves through decreased energy costs in less than 2 years.

Investment in new equipment is very likely to be the most effective means of increasing energy efficiency. As of 1975, 57 percent of all capital equipment in manufacturing was 25 or more years old. Much of this equipment was built wherever space permitted at existing industrial sites and with little regard for minimizing energy losses. In new plants, final products can usually be made with less energy. However, investments in new processes and process equipment, especially in the 1981-82 economic environment, have been rare, a situation that also existed throughout the late 1970's in some industries. Capital costs are now very high, and in the present investment climate, risks seem great. Many consider it better management to delay investments rather than risk damaging the economic health of their companies.

Another trend, the shift to less energy-intensive products, will also contribute to increasing energy efficiency per economic output. This phenomenon accounted for about 10 percent of the total reduction in industrial energy in 1981 relative to a continuation of the 1950-73 trend. Product mix shifts will occur within specific industries and will also result from one industry growing while another declines. Product shifts can also result from the introduction of new or improved products that provide a given service but require less energy to manufacture than do the products they replace. Product shifts are driven by changing demand patterns, international competition, and increasing production costs (including energy costs).

To assess technical and economic opportunities for improving energy efficiency, OTA projected industrial energy demand based on assumptions about future energy prices, product demand, interest rates, and the use of a range of technologies available for increasing energy efficiency. Table 2 presents the energy price assumptions. Table 3 presents a summary of energy growth rate pro-

Table 2.—Average Industrial Fuel Prices Assumed in OTA Modeling^a (1980 dollars per million Btu)

| | 1980 | 1985 | 1990 | 2000 |
|------------------------------------------|------|------|------|------|
| Gas | 3.0 | 5.0 | 6.3 | 9.0 |
| Residual oil | 5.0 | 5.0 | 6.2 | 9.0 |
| Distillate oil | 6.7 | 6.6 | 7.7 | 10.5 |
| Coal | | 2.1 | 2.2 | 2.3 |
| Electricity (at 3,412 Btu/kWh) | 12.6 | 13.8 | 13.7 | 13.8 |
| Steam | 5.5 | 5.9 | 6.3 | 7.4 |

Assumptions
 Gas —Price follows Natural Gas Policy Act (Public Law 95-621) deregulation scenario
 Residual oil —Follows Energy Information Administration's (EIA) projected refinery acquisition crude oil price (steady at \$32 through 1987, then up to \$58 by 2000)
 Distillate oil —Commanding a high premium over crude oil because of growth in demand
 Coal —Follows EIA forecast of low growth in mine and transportation prices
 Electricity —Follows oil and gas prices in 1960's, then shifts to those of coal
 Steam —Price affected by boiler/cogenerator mix and natural gas/coal fuel demand

^aOTA's modeling effort actually uses a range of fuel prices that reflects the quality of fuel and the different energy prices in various geographical regions of the United States

SOURCE: Office of Technology Assessment

jections and their relationship to overall production in the entire industrial sector and in the case-study industries.

Two major conclusions may be drawn from the data in table 3. First, from the standpoint of the entire industrial sector, including mining and manufacturing, available technology and expected energy price changes* will allow industrial output to grow at a much faster rate than that of energy use. **OTA projects that for the next two decades industrial energy use can grow at a rate of not more than 1 percent per year, with a 2.7**

*Although OTA has not modeled fuel price sensitivity in detail, higher price increases are expected to cause even greater efficiency gains, and a lower energy growth rate.

percent per year average growth rate in the gross national product (GNP). This compares to an energy use growth rate of 3.1 percent per year from 1950 to 1973 relative to a GNP growth rate of **3.8** percent per year. Moreover, the output growth projected here will occur with virtually no increase in the use of the two premium fossil fuels—natural gas and oil—because coal and electricity (generated from coal or nuclear fuels) can provide the energy needed for growth. Dependence on premium fuels will still be high and industry will remain sensitive to oil and gas prices. Figure 1 shows the projected changes in energy used by industry.

Second, in three of the four major industries closely examined by OTA, **the two major alternatives for improving energy efficiency, product and process shifts, will bring about greater improvement than will retrofit and housekeeping measures.** However, product and process shifts are by far the most expensive investments and depend on a strong product market to make them economically attractive. These large investments, however, do more than save energy; they increase overall productivity by reducing the costs of all factor inputs and by improving product quality. Indeed, the latter are the primary goals of such investments, and without productivity improvements, energy efficiency gains will be considerably less.

An important point to note is that these investments are long term, for the most part; i.e., their major effects will not show up until the 1990's. Furthermore, these efficiency improvements will continue past the year 2000 as new

Table 3.—Relative Energy/Output Growth Patterns for Years 1980-2000 (percent per year)

| | Paper | Petroleum | Chemicals | Steel | Total sector |
|--------------------------------------------------------------------|-------|-----------|-----------|-------|--------------|
| Product output growth rate ^a | 2.9 | -0.3 | 4.0 | 1.2 | 2.7 |
| Change in energy growth from: | | | | | |
| Product/process shifts | -1.0 | +0.5 | -1.7 | -2.0 | -1.7 |
| Improved efficiency from existing processes and machines | -0.7 | -1.2 | -0.6 | -0.4 | |
| Results in: | | | | | |
| Energy demand growth | 1.2 | -0.7 | 1.7 | -1.7 | 1.0 |

^aIn this projection, the industrial sector includes the activities of mining, construction, and agriculture as well as manufacturing. Growth in industrial output was projected by the Mellon Institute, using the macroeconomic models of Data Resources, Inc., and Dale Jorgenson Associates, Inc. In terms of these two models of the U.S. economy, a 2.7-percent growth in industrial output is consistent with a similar rate of growth for the gross national product. For further discussion of macroeconomic assumptions and analyses see *Final Report: Industrial Energy Productivity Project*, Energy Productivity Center, Mellon Institute, September 1982, pp. 11-24.

SOURCE: Office of Technology Assessment.

processes and process technologies become a larger share of total production and as production of less energy-intensive products becomes a larger portion of overall industrial output. **For the 1980's, increases in efficiency will be largely the result of retrofit and housekeeping measures and investments in new equipment made during the 1970's.**

Investment Considerations

In setting overall priorities among different product lines and production facilities, firms place energy efficiency in the context of a larger strategic planning process. * In all cases analyzed, industry was found to make investment decisions that affect energy efficiency on the basis of a strategic planning process that considers not only energy costs, but also a number of other factors. The most important of those factors are:

1. **Perception of product demand:** In particular, energy conservation projects in product lines that are declining are not considered good investments, even at very high rates of return. On the other hand, energy conservation projects in product lines whose markets are expanding will be undertaken at even moderate rates of return.
2. **Perception of competition:** Competition can arise either from a technological basis, such as the challenge of electronic mail to the paper industry, or from foreign competitors within the same industry, because of lower labor costs, lower capital costs, and so forth.
3. **The cost of capital:** Corporation managers invest their money in projects related to one of the four investment categories or in some type of revenue earning account. Funding required beyond that available within a company comes primarily from borrowing. Given the economic circumstances of 1980 and 1981, one of the major barriers to investment in energy conservation projects is the very high cost of capital. Also, because banks, insurance companies, and other fi-

nancial institutions are reluctant to commit funds to organizations with large debt loads, many firms find themselves with capital funds constrained by debt-related factors. As a result, companies are forced to limit their investment in new projects, and many high-return, energy efficiency-improvement investments are foregone.

4. **The cost of materials and labor:** A project may be energy efficient yet still economically undesirable if it requires more expenditure of labor or uses more material than is presently used. For instance, it is possible for integrated paper manufacturers (i.e., those who produce both pulp and paper, rather than purchase pulp to make paper) to become even more energy self-sufficient by burning more of their wood feedstock. However, this practice would result in less pulp available for other uses. At current energy prices, this trade of material for energy would be unacceptable.
5. **Government policy,** or lack of certainty about Government policy. Government policy can address investment in general or be targeted specifically to energy. Of major importance are those policies that affect the entire economy, since investment can be particularly constrained during periods of depressed economic activity.

When all capital projects being considered by a corporation are examined, the investment menu can be divided into mandatory and discretionary categories. OTA has found that mandatory projects are by far the most numerous. Discretionary capital funds are those that remain after mandatory investments have been made. Mandatory projects such as pollution control equipment and projects needed to support a capital expansion are generally not affected by energy costs and the five factors just listed above.

Discretionary capital investments, however, are subjected to the corporation's strategic planning process, which is guided by the six (including energy costs) factors. In some companies, the decision to invest in discretionary projects comes only after a very formal process. In other firms examined by **OTA**, the process seems less formalized, but still subject to the perceptions of

*There are, of course, many small investment opportunities, some energy-related, which may not be subjected to exhaustive strategic analysis. Funds for such projects are usually allocated by a supervisor or plant manager from a small discretionary pool of funds in the annual budget.

managers about growth potential of a product; market and technological competition; and use of capital, labor, and materials.

Energy efficiency investments fall within the discretionary category. All firms regard **energy efficiency as one more item in which they could invest, not as a series of projects that are different from other potential investments.** In no case has OTA found companies that accord energy projects independent status. Rather, energy-related projects are part of the general strategy governed by the factors listed earlier. These projects must contribute to the corporate goal of increased profitability and must enhance a corporation's competitive position.

While ideas for energy conservation can arise from anywhere, even outside a company, the approval process can often be complex and the project analysis, exhaustive. OTA found that technical decisions tend to be separate, and subservient to, corporate financial decisions. Plant engineers are usually not participants in detailed financial assessments.

In general, individual project financing is not considered when a large list of projects is being evaluated for their technical merits, despite the fact that when returns (i.e., energy savings) are high and a project is highly leveraged (i.e., much of the money used to buy the equipment is borrowed), the individual returns for each dollar invested can be very high. Large corporations consider borrowing funds only at the highest decisionmaking levels and when **all** projects have been evaluated. At that time, the decision to borrow is guided by the strategic considerations listed earlier and depends not only on the returns of an individual project, but on such corporate-wide parameters as debt-equity ratio, debt-service load, and bond rating. **Because project economics and corporate finance are treated separately by corporations, a Government policy which is designed to promote energy efficiency by influencing only project economics, but fails to affect corporate finance, will be ineffective.**

Case= Study Industries

Investment decisionmaking by the case-study industries illustrates the importance of the several investment factors and indicates the technology choices being made.

Pulp and Paper

In the U.S. pulp and paper industry, investment strategy is affected by the relative freedom from import competition (no other nation except Canada has a comparable resource base of marketable timber) and by the industry's close association with the wood building products industry. The absence of import competition and the presence of significant export prospects have been major factors in keeping profits and investments high. The paper industry's special relationship with the wood building materials industry is competitive in that they share the same resource base; it is also cooperative, in that firms tend to be engaged in both industries in order to spread risks and to pool capital investments in timberland and in wood harvesting and handling technology. Pulp and paper firms perform little research and development; instead, they rely on that of equipment suppliers.

Energy conservation improvements in the pulp and paper industry have come about through improved housekeeping measures and increased capability to recover energy from waste. In the latter case, the industry moved from supplying 41 percent of its energy needs from self-generated sources in 1972 to 50 percent by 1981.

OTA projects that the energy intensity of paper production—i.e., the energy required to produce a ton of product—will decline by nearly 18 percent by 2000 (fig. 2A) because of specific process changes anticipated for each of the papermaking steps and from changes that should occur in overall energy production and use in the paper industry. In particular, major economic opportunities exist for cogeneration. Also, pulping energy demand will likely decline, owing to the increased use of continuous digest-

Figure 2.—Energy Intensity Projections, 1970-2000

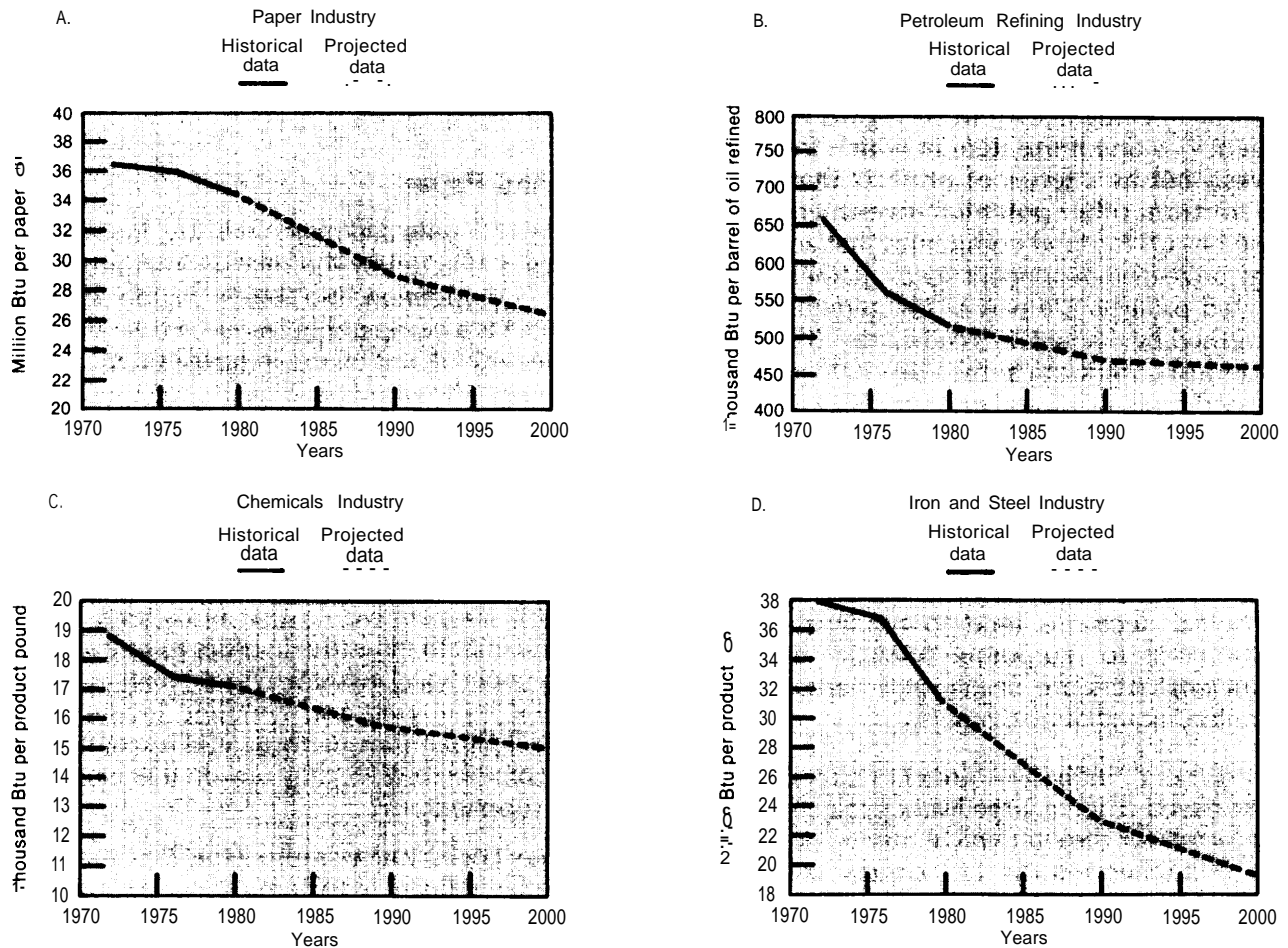

SOURCE Office of Technology Assessment

ers (as opposed to batch processing). In addition, projected secondary fiber pulping—i.e., recycling of wastepaper such as newsprint—will contribute to the decline. Energy savings can also be expected in the bleaching process by displacing energy-intensive chemical bleaching with oxygen-based bleaching, assuming technological risks of equipment failure and plant downtime can be minimized. In the papermaking process, energy can be used more efficiently if computerized process control and new technology can be employed. Also, if natural gas prices continue to go up, this industry can be expected to

substitute electricity for gas in its paper drying processes.

Overall, the pulp and paper industry mirrors aggregate industrial trends, except that its oil use will decline rapidly as number 6 residual oil is displaced in boilers by coal and biomass fuels. This industry is unique in its long history with biomass fuel (primarily wood) because of its dependence on biomass feedstocks. The biomass fuel alternative will look more attractive in the future as fossil fuel prices rise. Over the next 20 years total energy per ton of paper shipments

should decline by over 25 percent, while purchased energy should drop by 42 percent. The difference reflects an anticipated increase in the industry's use of biomass fuels.

Petroleum Refining

The domestic petroleum refining industry is dominated by vertically integrated firms that produce crude oil here and abroad and sell petroleum products to final consumers. Since petroleum production has been and should continue to be profitable, investment in domestic refining will be limited by available funds only in the sense that refining activities must compete with exploration and drilling.

The domestic refining industry is getting smaller because of the reduction in demand caused by the rising prices of petroleum-based fuels relative to prices of all other fuels and other goods and services in general. This situation has led to the substitution of other products for petroleum products and hence has reduced the demand for refinery outputs. In 1981, the refinery utilization rate was only 65 percent of capacity. At the same time, the refinery product slate was shifting away from regular, leaded gasolines to unleaded, higher octane products and to a steadily declining fraction of residual fuel oil. Also, there was a shift in crude oil away from the more easily refined light, low-sulfur crude oils toward heavier, high-sulfur crude oils.

The OTA projection presented in table 3 shows energy use in petroleum refining operations to decline 0.7 percent per year. This reduction is primarily the result of retrofit and housekeeping measures. The shift to heavier, high-sulfur crude oil feedstocks, combined with the market requirements of high octane, unleaded motor fuels, necessitates a growth in energy use of 0.5 percent per year to accommodate these product and process shifts.

Of the four industries studied by OTA, petroleum refining is the only industry in which product or process shifts are not projected to lead to less energy use. Nonetheless, overall energy efficiency, as reflected in the decline of energy intensity in refinery operations, can be expected to improve, as shown in figure 2B. The average

energy intensity is projected to decline by nearly 10 percent from 1980 to 2000. This reduction will be the result of a number of anticipated technological changes in refinery operations, primarily in distillation and cracking.

In distillation, energy can be conserved through improved efficiency in distillation heaters, extensive use of vapor recompression and waste heat boilers to maximize the recovery of heat content from waste streams, and the use of computerized process controllers to optimize plant operations. New process technologies should be available to convert undistilled residual oil (called residuum) to middle distillate products suitable for further refining and, at the same time, produce steam for plant process use. Thus, while use of fossil fuel for heaters is expected to grow slightly as the economy expands, demand for steam from boilers will decrease. Overall electricity use will grow because of the use of vapor recompression. In the cracking processes, increased efficiency from the use of vapor recompression and process control will be partially offset by the increased need for energy to perform hydrocracking operations on the heavier, more sulfur-laden, crude oil feedstocks.

Regarding shifts in refinery fuel, the projection of existing trends indicates that there will be a substitution of coal for gas in fuel boilers and as a source of hydrogen in reforming. But the extent of both changes will depend primarily on the price of natural gas. Gas price also affects substitution of gas for oil. If natural gas prices increase sufficiently, oil could be substituted for gas in direct heating.

Chemicals

The chemicals industry is the most dynamic of the four industries examined by OTA. It makes the most diverse set of products. The greatest portion of its energy use occurs in the production of commodity chemicals such as ethylene, polyethylene, benzene, and the like. The proportion of energy use is less in intermediate and final consumption chemicals, such as pharmaceuticals and agricultural pesticides.

The chemicals industry uses the largest amount of energy-bearing materials of the four industries

examined by OTA. Its use of both total energy and premium fuels—i. e., oil and natural gas—is larger as well. **The energy intensity of the chemicals industry over the next two decades is projected to decrease by about 9 percent** (fig. 2c), resulting from a combination of retrofit equipment and technical innovation in new processes; e.g., vapor recompression, process controls, and heat recuperators and exchangers that will all be used to improve thermal efficiencies. In addition, there is a distinct trend in this industry toward increased use of electricity and coal and away from premium fuels. For instance, as processes for producing ammonia and methanol from coal come onstream in the next two decades, less natural gas will be required and more coal will be used. The OTA projection indicates natural gas use will go from 45 percent of the total energy used in the chemicals industry in 1980 to 19 percent in 2000, while coal will increase its share from 6 to 29 percent.

For chemicals, probably the most important source of improvement in energy intensiveness is shifting the product mix. This shift—from energy-intensive commodity chemicals to higher value pharmaceuticals, pesticides, and other consumer products—is occurring for two reasons. First, profit margins on commodity chemicals are low, while margins are higher for lower volume, higher valued products. Demand for the latter is growing much faster, so that these less energy-intensive products are attracting the bulk of investment in the United States. Investments in processes for manufacturing chemicals such as ammonia and ethylene are low because large supplies have recently come on the international market from OPEC and other energy-rich nations that view the production of commodity chemicals as the best way to increase revenues and to expand industrial employment.

Steel

Among the four key energy-using industries, steel now suffers the most from declining domestic sales. In addition, older, large-scale, integrated firms also suffer from competition from domestic

minimills that can produce steel at much lower costs. Investment strategies vary a great deal between the older, integrated firms and the newer minimills. The former have been forced into triage, sacrificing older mills to husband resources for their most efficient and highest profit operations. Even for the latter, many energy-related projects cannot be undertaken because of limited funds or because of abnormally low use of existing capacity. At minimills, capital availability does not now appear to constrain investment in energy efficiency or for any other objective as long as target hurdle rates* for returns on investment are achieved.

OTA projects that energy use by the steel industry could decline at a rate of 2 percent per year, while output would grow at an annual rate of about 1 percent. The major source of this energy efficiency improvement will be process change—in particular, the replacement of ingot casting by continuous casting and the substitution of the electric arc furnace production (using scrap metal feedstocks) for the blast furnace/basic oxygen furnace combination (using iron ore feedstocks). The latter change will also result in the substitution (in the form of electricity) of steam coal for metallurgical coal.

OTA projects a decline in energy intensity of about 39 percent from 1980 to 2000 (fig. 2D). This decrease will result from the decline of the integrated production of steel and from the continued improvement in the amount of steel produced by electric arc facilities and continuous casting. Growth in mini mill steel production will result in a decline in hot metal production from open hearth or basic oxygen furnace operations and a decline in coke production and coke use. With continuous casting, there will be significantly more energy saved than with batch operations.

*An investment hurdle rate is defined as the minimum return a project must have to be acceptable to a firm.

POLICY OPTIONS

To assess the effects of a range of incentives on energy use in industry, OTA selected a set of policy initiatives directed at energy or corporate investment. These options include the following:

- Option 1: Removal of the accelerated cost recovery system (ACRS) provisions of the 1981 Economic Recovery Tax Act.
- Option 2: Addition of a 10-percent corporate income tax credit for investments in energy efficiency-improving equipment.
- Option 3: Imposition of a premium fuels tax of \$1.00 per million Btu on petroleum fuels and natural gas.
- Option 4: Lowered interest rates as a surrogate for capital availability.

In addition, OTA attempted to determine how these policies would most affect the operation of a corporation. While the analyses can be used to project absolute energy use in each policy option case, their primary benefit is to allow a comparison of each legislative option to the reference case.

REFERENCE CASE

The Current Economic and Legislative Environment, Including the 1981 Economic Recovery Tax Act

projections of total industrial energy demand and fuel mix for the reference case have been shown previously in figure 1. These projections were based on the energy price assumptions shown in table 2 and on the economic growth rates shown in table 3. In figure 3, OTA projects industrial sector energy intensity between now and 2000. Given the reference case, with its assumption of the current legislative environment, including ACRS depreciation, purchased energy use per dollar of industrial output should decline from a 1980 level of over 50,000 Btu per dollar to under 35,000 Btu per dollar by the end of the 1990's.

Two points should be made about the projections presented. **First, improvements in energy efficiency are due primarily to investments in new processes and process equipment.** These investments and the demand for energy, how-

Figure 3.—Industrial Sector Energy Intensity Projection, 1972-2000

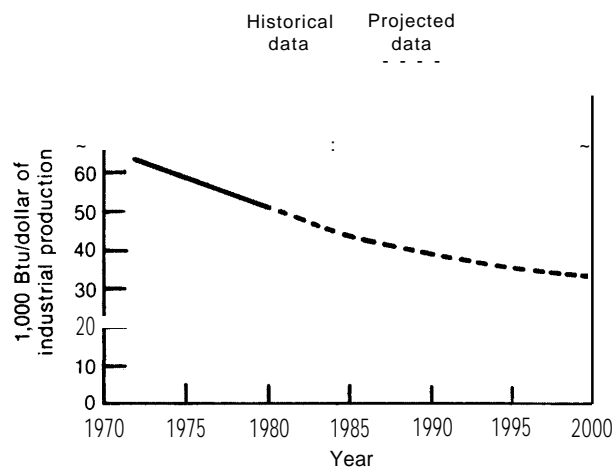

SOURCE: Office of Technology Assessment

ever, depend greatly on future profitability and, therefore, on economic growth.

Second, projections of the four major sources of industrial energy indicate that natural gas and oil use will remain more or less steady, electricity use will grow at about the same rate as total product growth, and coal use will grow at twice the rate of electricity. The projected, relatively rapid growth of coal results from the expectation that virtually all new large industrial boilers will be coal-fired. However, depending on the price of natural gas and on whether it will compete on the margin with residual oil or coal, the future paths of oil and gas could be reversed. The less expensive that gas is, relative to oil, the more likely it will be that existing oil heating will be converted to gas heating. Finally, electricity use will keep pace with final product demand. Efficiency improvements in electric motors will be offset by increased use of electric drying. Depending on the price of purchased electricity and the environmental restrictions on industrial cogeneration, a large share of this growing demand for electricity may be supplied by onsite generation.

Figure 4 presents a comparison of energy use in 1990 and 2000 under the reference case and under each policy option. It also presents a chart showing energy saved in 1990 and 2000 (corn -

Figure 4.—Industrial Sector Projections

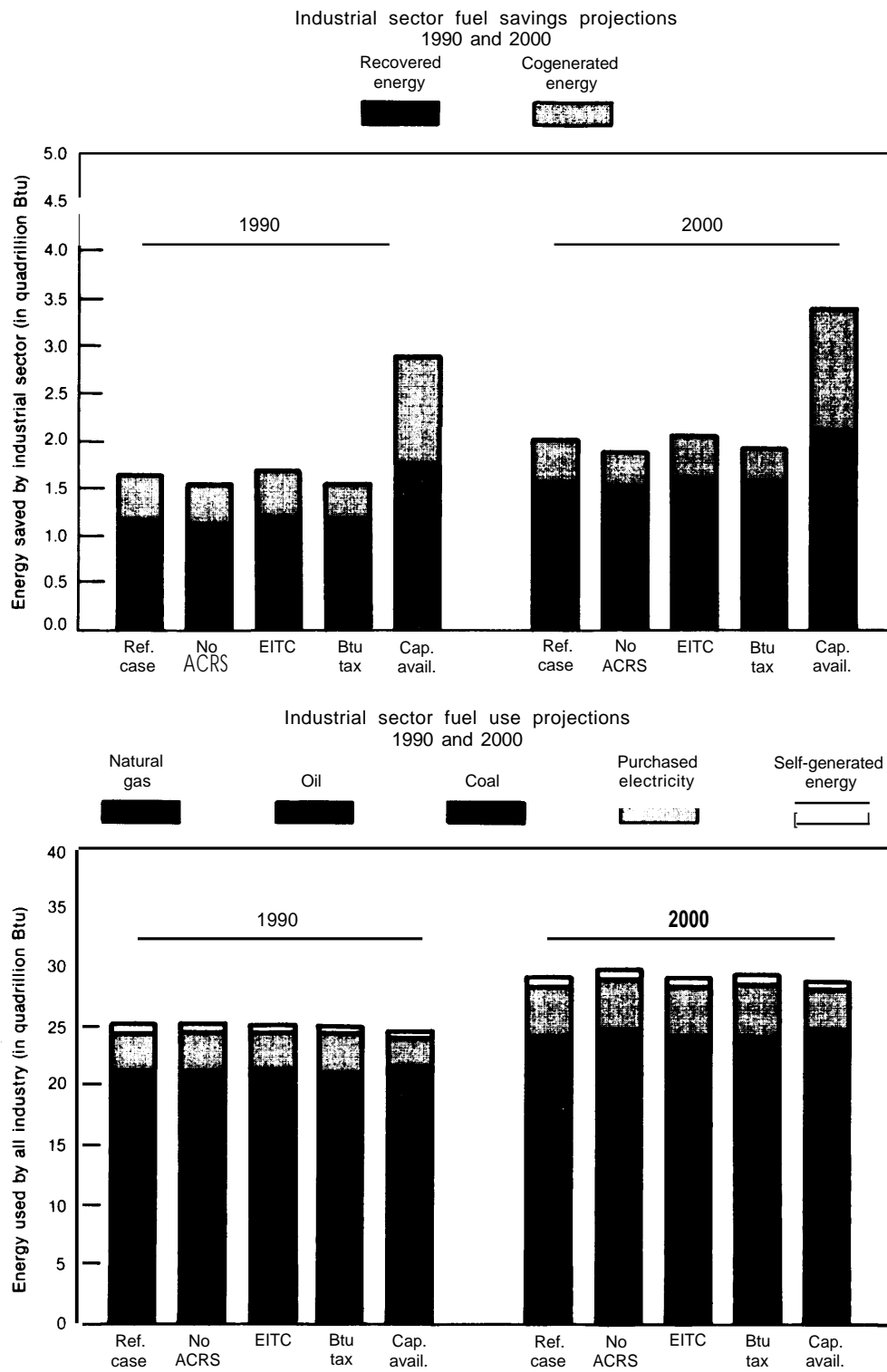

SOURCE: Office of Technology Assessment

pared to a 1976 base) under the reference case and under each policy option. Following figure 4 is a discussion of each policy option, its impact, and the energy projected to be used if it were effected.

OPTION 1

Removal of Accelerated Depreciation

The ACRS can be a stimulus for investment, provided industry is profitable. Under these circumstances, the ACRS would likely accelerate investment and, as a result, there would be a corresponding acceleration of energy efficiency improvements as old equipment is replaced. Consequently, removal of the ACRS would slow the rate of improvement in energy efficiency, but only if economic conditions improve so that substantial and sustained investment were relatively unconstrained. **Currently, however, factors such as high interest rates, high debt/equity ratios, and low to moderate product demand, are the factors limiting investment decisions. Under these conditions, the absence or presence of the ACRS will have little effect on industrial energy efficiency.**

Under a condition of restrained product growth, the most significant shifts in energy use arising from the removal of the ACRS would involve cogeneration and capital-intensive conservation technologies. OTA projects that market penetration of these two categories of equipment would be restricted if depreciation periods reverted to pre-ACRS schedules. A decrease in cogeneration would cause a decline in the self-generation of electricity and in waste heat energy recovery. Additional requirements for boiler-generated steam, to make up for the loss of steam for cogeneration, would cause an increase in coal use above that used in the reference case in each of the four industries.

Finally, both the ACRS and the energy investment tax credits, discussed next, create situations where third-party financing for tax shelter purposes can be attractive to individual investors who wish to shelter personal income. Such situations can create opportunities for investments that can lead to increased energy efficiency, particularly cogeneration. However, uncertainty

about the Internal Revenue Service's approval for these arrangements has prevented many of them from occurring.

OPTION 2

Targeted Energy Investment Tax Credits

Energy investment tax credits (EITCs) at a 10-percent level have little direct influence on capital allocation decisions in large American firms, and thus have little influence on energy conservation. These credits appear to be too small to exert any change on the returns on investment of most projects or on the cash flow of a company. A firm has an overall objective of increasing productivity, and therefore profitability, when it makes an investment in energy-using equipment. Energy is just one of many factors determining productivity of a given process, and a targeted incentive, such as the EITC, is diluted to the degree energy efficiency must compete with other factors of production for investment priorities.

In particular, the shift of 2 to 4 percentage points in a typical 20-to 30-percent return on investment on a project brought about by a 10-percent EITC is usually not enough to cause a firm to reorder the priorities of its capital allocation plan. In some industries, OTA found that case-study firms claimed only 1 percent of the dollar amount for EITCs compared to that claimed for the general investment tax credit, an indication of the dilution that exists when targeting just one of several factors of production compared to targeting the entire investment. In this connection, **tax credits applied to cogeneration are more effective, particularly to third parties whose only objective is the production of cogeneration equipment.** Under these conditions, such credits can make the difference between going ahead with the investment or not.

A further barrier to the EITC is the decisionmaking structure of the firm. In some case-study firms, OTA found that the technical staff who decide on the engineering merits of a particular project often have no authority or responsibility for the financing considerations of the project. Such arrangements as third-party leasing and leveraged capital purchases are the responsibility of the

financial offices. Therefore, the management staff that has the final decision on whether or not to undertake energy-related projects may not be the staff that is aware of all the technical opportunities that exist in an industrial facility. OTA's survey of firms in the energy-intensive industries indicates that economic calculations for individual projects are carried out on the basis of 100-percent equity financing, the rationale being that this is the only way projects can be accurately compared. Only when considering the finances of the entire corporation, such as its debt load and debt-to-equity ratio, is leveraging (i.e., borrowing) considered.

In the steel industry, there is support for tax credits, but only from the standpoint of cash flow. That is, industry representatives agree that tax credits do little to move energy projects ahead of other possible investments; instead, they provide additional money from the energy projects that are taken on (and would have been taken on anyway), that can be used in general corporate operations. OTA projects that even if extending the EITC caused a slight increase in waste energy recovery in the iron and steel industry, the impact on the entire industry in terms of overall increased energy efficiency would be negligible.

The response of the chemicals industry to EITCs ranges from active support in one case, to neutral indifference in most cases, and corporate antipathy in a few others. Some chemical firms suggest that modest EITCs serve as indicators to the manufacturing sector of the value the Government places on energy efficiency improvements. However, it appears that a 10-percent EITC is less effective than are existing and anticipated energy prices in heightening corporate managers' awareness about energy conservation. As with steel, the impact of the modest 10-percent EITC on the overall energy use in the chemicals industry is projected to be negligible. For petroleum refining, the principal effect is projected to be a small increase in cogeneration, reflecting the higher leverage these credits have on energy production projects.

OTA has been unable to find any projects throughout all the case-study firms where a deci-

sion to undertake a project hinged on gaining a 10-percent tax credit. overall, the impact of a 10-percent EITC on the total industrial sector is judged to be minimal. For the EITC to be effective, it would have to be substantially increased, probably to above 40 percent.

OPTION 3

Tax on Premium Fuels

Taxes at a rate of \$1 per million Btu on natural gas and petroleum fuels—equivalent to about a 25-percent tax, or to \$6 per barrel of crude oil—would change the fuel use mix in industry and would cause energy efficiency to improve slightly. In the case of coal, a premium fuels tax would only add to an already large price differential, and therefore the economic incentive to switch to coal would not be significantly increased. For electricity, the tax would be more important in terms of relative prices, but the limited existence of new technologies that efficiently use electricity to replace petroleum or natural gas will constrain conversion to electricity for several years.

Efficiency improvements that result from the premium fuels tax would be a few percent greater than those of the reference case. There are two major reasons for this small increase. First, the overall total cost of energy, despite a 25-percent increase in the price of premium fuels, will be considerably less than 25 percent, since gas and oil account for about 60 percent of total industrial fuel use. The net price increase will not greatly accelerate the incentive industry already has to invest in new process technology. Second, a tax just on premium fuels would provide an incentive to switch fuels, which would not necessarily increase overall energy efficiency.

The tax would have different consequences for each of the industries investigated. Within the pulp and paper industry, a premium fuels tax would accelerate the industry toward more energy self-sufficiency through use of biomass, and would increase their use of coal. A number of firms are considering replacing their oil-based, steam-generating facilities with fuel-flexible or coal-based ones. Such a tax would accelerate this

change. A premium fuels tax is projected by OTA to decrease natural gas consumption in the pulp and paper industry by 5 to 10 percent. Much of this decrease would result from a cutback in cogeneration, with the result that the amount of electricity purchased from utilities would increase.

Since coal is the dominant fuel in the steel industry, a premium fuels tax would have a small impact. In 1987, the steel industry derived only 4 percent of its energy from petroleum sources, and less than 25 percent from natural gas.

The petroleum refining industry might be affected by a premium fuel tax in two ways. First, the tax would cause some reordering of energy-related projects to positions ahead of other capital projects. In particular, coal use for refinery operations would increase, while use of natural gas and cogeneration would likely decrease. Second, the fuel tax would undoubtedly decrease the industry's earnings through a general decrease in demand for its products.

The domestic impact of a premium fuels tax on the chemicals industry is less foreseeable. The largest effect of a premium fuels tax on the chemicals industry would likely be the negative impact on the ability of the chemicals industries to export products because of the resultant: 1) higher prices on U.S.-produced goods in overseas markets; and 2) the increased cost advantage for foreign firms to sell their products, both in the United States and throughout the world. OTA projects the direct impact of a premium fuels tax would be an increase in the use of coal and a decrease in the use of natural gas. As with the other industries, cogeneration, using natural gas, would also decrease relative to the reference case. Finally, the tax would probably cause a slight reordering in project priorities.

OPTION 4

Lowered Interest Rates as a Surrogate for Capital Availability

Corporations have a strong motivation to invest in new production equipment to maintain or improve their market share. If these corporations also perceive energy prices to be high and

believe they will go higher, they have considerable incentive to make sure those investments increase energy efficiency. Therefore, low interest rates affect energy efficiency to the extent that lower rates may allow a company's cash flow to go further, its debt service to be less burdensome, and its ability to take on more debt to increase. In all cases, low interest rates increase the effective availability of capital and therefore allow more projects to be undertaken. Even with an attractive interest rate, however, investment will be restrained unless there is a perception of profitability and increased capacity utilization.

In this connection, if interest rates were to fall considerably, automobile sales, house sales, and the like would improve; capacity utilization rates would rise; and corporate capital funding would expand. However, even under these circumstances, especially for firms in the four energy-intensive industries examined by OTA, some companies cannot borrow funds because they have already reached the debt ceiling imposed by their desired bond rating. In these cases, the size of corporate debt load, not the interest rate, is the problem.

OTA finds that the availability of low-cost capital would result in the most significant shifts in total sector energy use from that of the reference case. In this situation capital-intensive technologies, such as cogeneration and heat recovery devices, would be significantly more attractive and would find greater use. Coal use would be greater because of increased penetration in both process and boiler applications. An apparent anomaly would occur in natural gas use, where the consumption figure for 2000 would actually be 3 percent higher than that in the reference case. This increase would be entirely attributable to the projected increased use of natural gas in cogeneration. The impact of increased penetration of conservation technologies and of greater numbers of energy-efficient processes in the low-capital-cost case would be a decrease in total energy use that would equal a full percentage-point drop in 1990 and half a percentage-point drop in 2000.

In the pulp and paper industry, OTA projects a shift to more self-generated energy, with natural

gas and oil use down, but cogeneration increasing relative to the reference case. A low-interest cost of capital should bring about a 5- to 10-percent decrease in energy intensity.

The chemicals industry is somewhat unique in that OTA projects for it a slight increase in energy used per unit of chemical output if the cost of

capital were lowered. Low capital costs would permit a large cogeneration effort, which would increase natural gas use in this industry. However, electricity demand from utilities would decrease, and the sum of energy used by the utility and the chemicals industry would be lower.

EFFECTS OF POLICY OPTIONS ON THE INDUSTRIAL SECTOR

For the entire industrial sector, under the conditions of the reference case, energy intensity is projected to fall from its current level of approximately 51,000 Btu per dollar of industrial output to a low of 33,000 Btu per dollar of output by 2000. The curve in figure 3 illustrates this as well as the long-term nature of the investments made by industry that would result in increased energy efficiency. The rate of decline in energy intensity will be less during the 1990's than in the 1980's. This decline should continue well past 2000 as the fraction of capital stock replaced by new processes and process equipment continues to grow. **During this period, the use of coal should increase from 5 percent of the total energy consumed to almost 18 percent as coal becomes a major fuel for process heat and steam boilers. In addition, the amount of purchased electricity should nearly double.** This effect should be balanced by decreases in the use of natural gas, while use of petroleum-based fuels should remain about the same.

OTA has found that investments in new technology are driven principally by judgments about future profitability. This, in turn, is affected by increased product demand, productivity, and a change in product mix. Where product demand is expected to grow, as in the pulp and paper and the chemicals industries, investment in expansion will be large and, consequently, energy efficiency improvements will be extensive. Where large changes in production technology are necessary to avoid a substantial loss of market, as in the steel industry, expansion of the industry will not occur, but investment in new technologies will still be large. The technologies in which steel will in-

vest—primarily continuous casting and electric arc minimills—will also provide enormous increases in energy efficiency. Finally, where product demand is declining but a product mix shift will occur, as in the petroleum industry, investment will be needed to account for different product slates. In the case of petroleum, the changing characteristics of the crude oil feed stock and shifts away from heavy fuel oil and gasoline are the major factors. Again, efficiencies will result, although to a lesser extent than with other industries because investment will be less.

The policy options investigated by OTA do not affect perceptions of profitability nearly as much as do product mix shifts. The policy options are primarily aimed at accelerating investment, once a decision has been made, or targeting certain aspects of that investment, in this case, energy. They are most effective for those capital-intensive items that are primarily concerned with energy, such as cogeneration. Even here, however, the attention to product demand and mix is so dominant that none of the options, with the exception of lower capital cost, changes the decision pattern of manufacturing by a great amount. **Given a healthy economy and reasonable access to capital, however, industry will make investments over the next few decades that will increase productivity and profitability and will have a positive effect on energy efficiency. This improvement can take place without additional Federal incentives.** The key is stable economic growth, without which even much larger incentives than OTA has considered will not be of much value.

Chapter 2
The Industrial Sector: Growth, Trends,
and Investment Behavior



Photo credit: American Petroleum Institute and Exxon Corp.

Contents

| | <i>Page</i> |
|---------------------------------------------------|-------------|
| The Industrial Sector | 21 |
| Size and Growth of the Industrial Sector | 21 |
| Industrial Productivity | 22 |
| Industrial Investment Decisionmaking | 24 |
| Uses of Capital*** | 24 |
| Strategic Planning | 26 |
| Factors That Influence Investment Decisions | 27 |
| Levels of Decisionmaking | 30 |
| Elements of a Strategic Plan | 31 |

TABLES

| <i>Table No.</i> | <i>Page</i> |
|-------------------------------------------------------------------------------------------------------------------------------------|-------------|
| d. Major Manufacturing Industry Groups as Listed in the Standard Industrial Classification Manual | 21 |
| 5, Sensitivity Analysis of Internal Rate of Return(IRR) Under Different Scenarios for Computer Process Control System 4 | 34 |

FIGURES

| <i>Figure No.</i> | <i>Page</i> |
|------------------------------------------|-------------|
| 5. Output in the Industrial Sector | 22 |
| 6. Distribution of Employment | 23 |

Chapter 2

The Industrial Sector: Growth, Trends, and Investment Behavior

THE INDUSTRIAL SECTOR

As defined by the Department of Energy (DOE), the industrial sector is essentially the goods-producing part of the economy. It is largely concerned with obtaining raw materials—through extraction or through animal and plant husbandry—and with the mechanical and chemical transformation of these materials and their derivatives. The industrial sector contains agriculture (including forestry and fisheries), mining (including oil and gas extraction), construction, and manufacturing. Manufacturing is the largest of the four in dollar value of output and energy use.

These four components of the industrial sector correspond to the first four of eleven divisions in the Standard Industrial Classification (SIC) system. The SIC system defines industries and groups of industries in accordance with the composition and structure of the economy. It covers all economic activity. The Federal Government and many other organizations use the SIC framework for collecting statistical data; many businesses use it to classify customers and suppliers. Table 4 lists the SIC major manufacturing industry groups.

Size and Growth of the Industrial Sector

The industrial sector accounts for nearly one-third of the gross national product (GNP). As revealed in figure 5, output (discounted for inflation) by the industrial sector has grown at a respectable rate since the end of World War II. Real industrial gross product increased 167 percent, or an average of 3 percent per year, between 1947 and 1980 (latest data available).

The industrial sector's proportion of overall U.S. economic activity has been decreasing, however, owing to two factors. First, service-type activities have grown more rapidly than goods-producing activities, a situation typical of highly industrialized economies. Gross product originat-

Table 4.—Major Manufacturing Industry Groups as Listed in the Standard Industrial Classification Manual (1972 edition)

| SIC code | Major group |
|---------------------------|--------------------------------------------------------------|
| 20 | Food and kindred products |
| 21 | Tobacco manufactures |
| 22 | Textile mill products |
| 23 | Apparel and other textile products ^a |
| 24 | Lumber and wood products |
| 25 | Furniture and fixtures |
| 26 ^a | Paper and allied products |
| 27 | Printing, publishing, and allied industries |
| 28 ^b | Chemicals and allied products |
| 29 ^a | Petroleum refining |
| 30 | Rubber and miscellaneous plastics products |
| 31 | Leather and leather products |
| 32 | Stone, clay, glass, and concrete products |
| 33 ^a | Primary metal industries |
| 34 | Fabricated metal products |
| 35 | Machinery, except electrical |
| 36 | Electrical and electronic machinery, equipment, and supplies |
| 37 | Transportation equipment |
| 38 | Instruments and related products ^b |
| 39 | Miscellaneous manufacturing industries |

^aIndustries groups examined in detail by OTA study

^bShortened title.

SOURCE: *Standard Industrial Classification Manual, 1977* (Washington, D C Office of Management and Budget, 1977).

ing* in nonindustrial divisions increased 243 percent between 1947 and 1980, or 3.8 percent per year on average, compared with 3 percent on average for the industrial sector. In 1980, gross product originating in the industrial sector represented 31.6 percent of the real GNP, a drop from 37.2 percent in 1947.

Second, among goods-producing activities, there has been a historical shift toward higher degrees of fabrication and more technologically advanced products. For example, gross product originating in the nonelectrical machinery, elec-

*Gross product originating in a division or industry is that part of the GNP attributable to the output of establishments in that division or industry. It is the sum of the factor costs of production (wages, salaries, profits, net interest, and so forth) and nonfactor costs, such as depreciation and indirect business taxes.

**Figure 5.—Output in the Industrial Sector
(billions of 1972 dollars)**

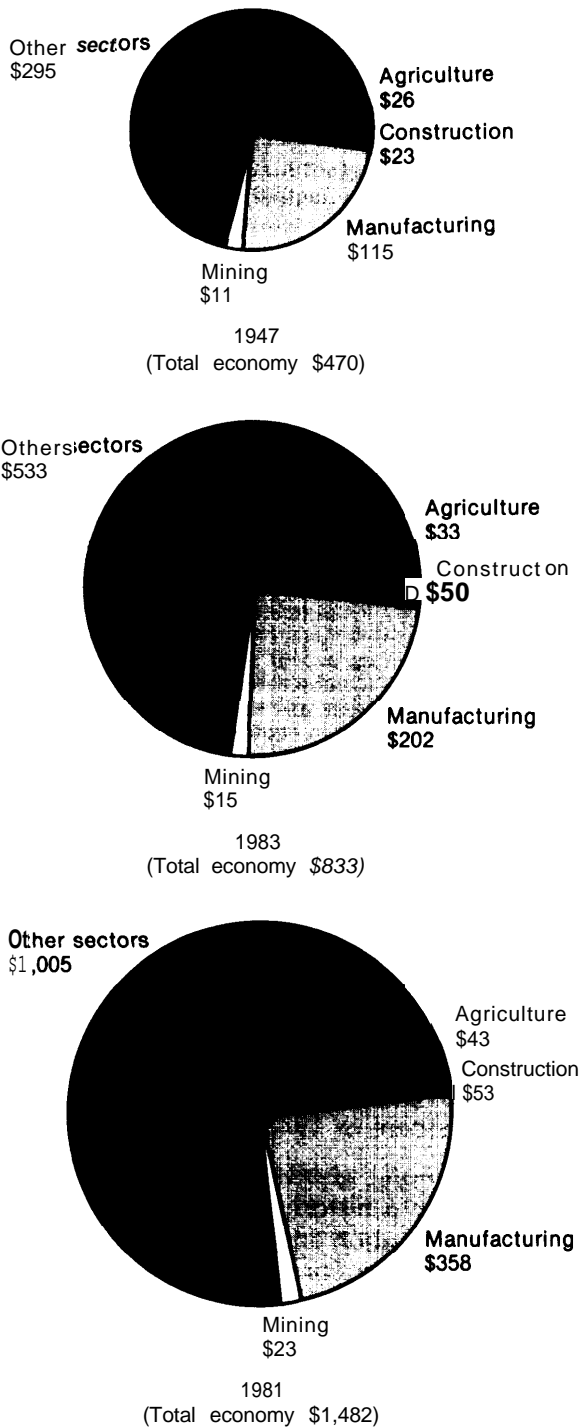

SOURCE: U.S. Department of Commerce, Bureau of Economic Analyses

tric and electronic equipment, and instrument and related products industry groups, combined, accounted for more than 6 percent of the GNP in 1981, compared to about 3.5 percent in the mid-1950's. In contrast, the combined share of the GNP accounted for by the primary metals and fabricated metal products industry groups fell from over 4.5 percent to less than 3 percent for the same period. *

Both the faster output growth of nonindustrial divisions and the shift to higher degrees of fabrication and more technologically advanced products have an important bearing on the level of energy use in relation to output in the industrial sector.

The industrial sector employs about 30 million people, or about 30 percent of the total employment in the U.S. economy (see fig. 6). This percentage is slightly higher (31 percent) when employment is figured according to the full-time equivalent of workers rather than by the number of full- and part-time workers. There are relatively more part-time workers in the nonindustrial divisions, particularly in trade and services. (Unpaid family workers, mostly in farming, are not included in this analysis.) Employment in the industrial sector has increased about 15 percent since 1947, while employment in the rest of the economy has more than doubled. Despite relatively low nominal wages in agriculture, employee wages in the industrial sector as a whole are about 1s percent higher than those in the economy as a whole.

Industrial Productivity

Industrial labor productivity, as measured by the amount of output produced per hour of labor used, has dramatically increased since World War II. Production per person-hour in manufacturing (which accounts for three-fourths of industrial sector output) grew at an average rate of 2.6 percent per year between 1947 and 1981, in

*Data on gross product originating by detailed industry group may contain considerable errors and are not published by the estimating agency—the Bureau of Economic Analysis (BEA) of the Department of Commerce. BEA strongly recommends that the figures be used with caution.

Figure 6.—Distribution of Employment in the Industrial Sector

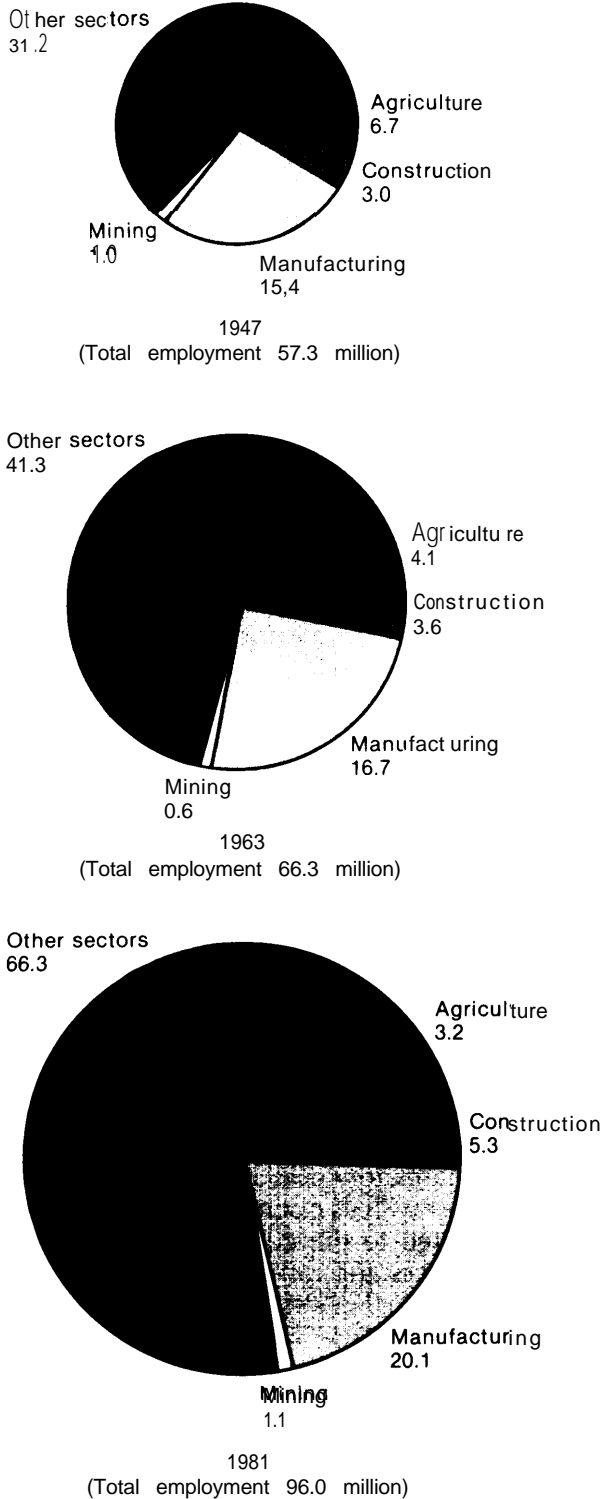

comparison, labor productivity in the private non-farm economy as a whole increased 2.1 percent per year on average during the same period. This contrast reflects the more rapid gains in labor productivity in goods production than in the production of services. Part of the substantial rise in labor productivity in the industrial sector has come about through the use of more energy. Yet, at the same time, the other factors contributing to higher labor productivity—improvements and/or increases in technology, physical capital, and the skills and education of the labor force—have also combined to actually decrease the amount of energy used per unit of output.

SOURCE U S Department of Commerce, Bureau of Economic Analysts

INDUSTRIAL INVESTMENT DECISIONMAKING

The significance of industrial energy demand in overall U.S. energy use has focused considerable attention on means of encouraging more rapid improvements in industrial energy productivity. A business decision to invest in new plant and equipment or in retrofits of old equipment for the purpose of cutting energy use (and thereby reducing costs) is made, however, in the context of many other competing criteria. An understanding of this decision making process is an important goal of this study.

The fiduciary duties and responsibilities of management are well known. In a modern society these responsibilities can be said to range from protecting shareholders' interests to assuring employee welfare and safeguarding the environment. These fiduciary obligations play a major role in the company's decision making process, ensuring that investments are prudent and that they protect the company's assets.

A well-managed company that wishes to expand its operations has many avenues open to it for raising capital and does not have to rely entirely on the current profits generated. These avenues range from selling company stock, to issuing interest-bearing paper—i. e., debentures, to borrowing the required amount of money and paying interest to a lending institution.

Management responsibilities in these areas are directed at ensuring that debts arising from borrowing or the issuance of stock do not overdilute or undermine the asset value of the company. It is this fiduciary responsibility, with its inherent emphasis on prudent management, that gives rise to financial planning and investment policies that are incorporated into a strategic plan. Decisions regarding all investments, including those related to energy, are made within this area of strategic planning.

Uses of Capital

Corporate funds can be used to pay the debt and debt service on existing loans; to pay dividends to stockholders, for such payments often serve to keep up the price of the stock so more

stock can be issued; and to pay for the working capital—i. e., everything from the company's inventory to the cost of raw materials. For many companies, working capital is the largest dollar expenditure but is allocated only after the first three items have been satisfied.

Once a company knows the size of its capital pool, it must decide how to allocate it. Certain projects are considered mandatory—e.g., pollution control equipment, equipment required for health and safety, and projects agreed to in collective bargaining. Also, some capital projects, especially those in the capacity expansion category, obligate a company to spend in certain ways to support a major project. Once a decision has been made to build a new pulpmill or a new blast furnace, completing a number of projects related to that decision becomes mandatory. Such things as purchasing additional transportation equipment for the new product would be in this category.

plants in the primary manufacturing industries are often very large. To take advantage of critical economies of scale, major expansion of industrial capacity in these plants involves large blocks of financial resources and delayed returns on investment during lengthy construction periods. To justify such investments, project lifetimes must be predictably long term. Such long-term forecasts are exceedingly difficult to make, especially during periods of economic instability. Consequently, at present, primary manufacturers requiring long-term investment commitments involve greater apparent risks than do industries that offer shorter term investment opportunities.

After all mandatory allocations are made, a company is left with its discretionary capital pool that is subjected to the corporation's strategic planning process for ranking investments. In some corporations, investment decision making is a very formal process. The company invests in only its most productive product lines and plants. In other firms, decisionmaking seems less formalized, but still subject to the perceptions of managers on growth potential of a product, market and technological competition, and use of

capital, labor, and materials. In no case has OTA identified companies that accord energy projects special status. All firms regard energy efficiency as one more item in which they could invest and not as a series of projects that differ from other potential investments. The economic incentive to save energy because of its high cost is counterbalanced by high capital and labor costs and increasingly costly raw materials.

To be effective in the marketplace, management must have a strategic plan. The approval process in developing the plan and its projects tends to be complex and the project analysis, exhaustive. Technical decisions tend to be separate from and subservient to financial decisions. The corporate engineering staff performs detailed technical analysis, estimating such factors as construction costs, potential energy, labor or material savings, and project lifetime. A return on investment is then calculated. In multi plant firms, proposals for capital projects are then submitted to the plant manager, who may approve certain areas and not others. This package is then sent on to the corporate staff for consideration with proposals from other plants. This capital fund request summary would be reviewed by senior corporate management, and only at this time would funding source, tax credits, and the like be discussed.

As shown previously in table 1 energy efficiency improvements are generally classified into four categories: housekeeping, equipment retrofit, new plant construction or capacity replacement, and product shift.

Housekeeping

Housekeeping refers to the substitution of labor and management inputs for energy. It includes: 1) closer monitoring of process streams and greater coordination of products in process in order to minimize delays and reject rates, 2) more frequent equipment repairs to increase average energy efficiencies, and 3) improved job skill training and motivation to minimize human errors. Because many of these alternatives are not expensive and involve a very large return for little effort, they are often the first actions taken by a company. The consensus of energy managers

and corporate investment analysts in the four industries studied by OTA is that most firms have done their housekeeping—that those things that can be readily adjusted, insulated, turned down, or turned off, have been.

Equipment Retrofit

Most existing equipment was installed when energy costs were expected to be much lower than they are today. Replacement with new equipment would offer the greatest improvement in energy efficiency and the greatest reduction in fuel costs (via fuel switching). However, since replacement is most expensive and a great deal of capital in place may not have been amortized, replacement would be tantamount to accepting large, lump-sum losses. The alternative is to retrofit existing equipment—e. g., by adding pipe insulation, combustion controls, more efficient motors, and heat exchangers to heaters and boilers in order to achieve their maximum design efficiencies; by adding computer controls to process streams in order to minimize deviations from optimum temperatures and pressures; and by adding or replacing a multitude of other process components whenever such installations do not significantly increase downtime.

Most important energy-saving retrofit alternatives involve well-proven technology. Several firms contacted used a lower hurdle rate for energy conservation projects because they were considered to be of low technical risk. On the other hand, while there are a multitude of retrofit project alternatives at any major industrial facility, the actual energy savings for a particular project may be severely constrained, or the investment outlays may be excessively large, because of the existing plant configuration.

New Plant Construction or Capacity Replacement

The most costly investment strategy (at least in initial capital outlay) is to build entirely new facilities that embody the latest energy-efficient technology or any technology that lowers cost and improves product quality. This alternative is frequently the most attractive to growing industries. However, in the four subject industries, this

choice is less attractive because a new plant must replace an old plant, with all the attendant losses of jobs, established ways of doing things, and even capital writeoffs if the old plant has not been fully depreciated. Curiously, new construction is attractive in the steel industry, which is experiencing the greatest overall decline in total domestic output. It occurs there at the initiative of relatively new minimill firms that reprocess scrap metal. These new firms are growing at the expense of older, established steelmaker.

Product Shift

Product shifts are unique to a given corporation and quite idiosyncratic. Whether the managers of a company choose to invest in maintaining their existing capital stock, add new capacity, or invest in entirely new product lines depends on how those managers view their industry. Parts of an industry may be more susceptible to com-

petition than others, or have higher costs or lower returns compared to other product lines in which a firm could choose to invest.

Of all the factors that enter into a firm's decision to invest, those that influence the two categories of new capacity or product switching are the most difficult about which to generalize. The managers of one firm may decide to stay with a product line or with an industry, while another group of managers may decide to expand to another product line or industry. Once a firm makes this type of evaluation, it locks itself into a particular kind of capital spending pattern. For instance, a paper firm that decides to build a new pulpmill commits itself to 3 to 5 years of capital expenditures before a single dollar in increased sales or increased net profits attributable to that investment is realized. This situation dramatically affects the size of the capital pool available for other projects.

STRATEGIC PLANNING

There are as many strategic plans as there are corporations because each corporation has its own procedures for strategic planning. For the purpose of this report, simple generalizations are given to illustrate commonalities.

Strategic plans tend to have a framework of 5 to 10 years, but are revised annually. Often, the chief executive officer devotes most of his attention to strategic planning. Such plans invariably identify the markets and the products that are most important to the company and direct management's attention to strengthening the most promising of these.

In a simplified strategic plan, business sectors are ranked, and often individual factories within a corporation are ranked. Most of management's interest, and most of the money for new investment, goes into highly ranked factories in highly ranked business sectors. A facility ranked low on both scales has little hope of acquiring new investment capital.

Strategic plans are based primarily on the assumption that a firm is operating in a normal business environment and is not prone to drastic

fluctuations in commodity and raw material prices, labor, interest rates, or other precipitous changes that cannot be anticipated. Therefore, in order for the strategic plan to work, the environment must be relatively stable. Although managements go to great pains to attempt to forecast disturbances in a worldwide environment, where factors ranging from political unrest to large changes in government policies take place, sometimes firms are surprised by unforeseen events and strategic plans break down. For example, overnight, the U.S. car industry became extremely vulnerable to the Japanese small-car import, a situation almost entirely due to events that took place in Iran in 1979 and to the subsequent 300- to 400-percent increase in world oil prices. The American car industry obviously could not have planned in the mid-1970's for the revolution in Iran.

Similarly, the whole infrastructure of the housing industry, from the basic forest products industry to the savings and loan bank mechanisms that finance it, has matured and grown on the basis of relatively low interest rates. The dramatic rise in interest rates in the late 1970's caused vast

dislocations to the market that could not possibly have been foreseen by the strategic planner of a forest products company planting trees 20 years ago, or by a mortgage broker planning his loan strategies in the 1960's.

Factors That Influence Investment Decisions

Fiduciary responsibilities strongly influence management thinking. The first and possibly the most overriding factor when dealing with investments is management confidence. In this context, the word "confidence" does not describe management's own view of its abilities, but describes instead management's perspective of all the relevant factors that make up and influence its enterprise.

Management must be confident, for example, that its investments are going to bear fruit. It is more likely to invest when it is confident that the market for its company's products is growing, or that the company can capture a larger share of the market, or that the general economic climate is improving. This confidence has a major impact on how management views the risks associated with an investment. As the confidence factor grows, the impact of a risk factor is minimized.

Furthermore, management must demonstrate to the financial marketplace that the company is financially sound and that its investment strategies and policies are well thought out. [It is not uncommon for the chief executive officer and/or his designated appointees to expend time and effort explaining these plans and strategies, not only to their immediate bankers, but also to Wall Street analysts, brokerage houses, and others in order to assure the decision makers in capital markets that money raised and investments made are prudently managed.]

The four industries examined for this report identified five factors that affect their strategic decisionmaking: product demand, competition, cost of capital and size of capital pool, cost of materials and labor, and general economic environment and Government policy.

Product Demand

Demand for primary industrial commodities depends on the general level of economic activity—i.e., the GNP. When the economy is growing steadily and existing capacity is fully operating, profits that depend critically on capacity factors are generally high, investment capital is generated internally, and new energy technologies can be adopted as soon as they become profitable. On the other hand, when the economy is stagnant or depressed, low-capacity utilization leads to low profits and curtailed investment. So even if energy-related profits have calculated a return on investment well in excess of normal corporate hurdle rates, they may not be implemented.

The generally accepted opinion seems to be that market opportunities for U.S. suppliers of basic industrial commodities are below average. Despite many uncertainties, analysis suggests that the advanced industrial economy is gradually saturating markets for durable manufactures and construction and moving into higher and softer areas of technology, such as semiconductor-based computation and communication. For example, in the steel and petroleum refining industries, more production capacity is now in place than is required for the next 5 years. In 1982, the steel industry used less than half its capacity. As long as the economy is sluggish from high interest rates, unemployment, and inflation, the steel industry will not use much of that excess production capability. In addition, with the recent U.S. recession, fewer durable goods, such as refrigerators and washing machines, are being sold, and some goods that are sold tend to be made of less steel.

The overcapacity (almost 30 percent) of petroleum refining in the United States, is due in part to the high market price of the fuels produced—which has in turn led to fuel conservation, the use of more fuel-efficient autos, and the switch from fuel oil to natural gas in residential heating. In both the steel and petroleum refining industries, then, it is clear that major new capacity expansions will not be undertaken. The existing capacity, although not as efficient as it could be,

will provide sufficient steel, petroleum, and associated products to meet anticipated growth.

In the paper industry, demand is forecasted to grow at 2.5 percent per year, given a GNP growth rate of about the same percentage. This anticipated growth is sufficient to encourage managers to plan for new capacity, although it would not be the only factor they would consider.

The chemicals industry expects product demand growth that exceeds that of paper and a continued ability to export products outside the United States. Because the chemicals industry has more product flexibility than do the other industries discussed so far, it can be expected to add new capacity on the basis of anticipated market growth, although, again, this would not be the only factor considered.

Competition

Perception of competition also exerts an influence on investment decisions. There are two types of competition: a technological one within an industry and market competition, both local and foreign. Although it is beyond the scope of this report to examine the competitive quality of products made by the four subject industries, the report does identify within each of the industry-specific chapters, new technologies in which these industries will most likely invest in the next two decades to help maintain or improve their competitive positions.

Two of the subject industries face severe market competition from foreign companies. The steel industry has initiated suits with the International Trade Commission, alleging that foreign producers make steel that is subsidized by their respective state governments. The "subsidized" steel is then sold in the United States at prices lower than that of domestic steel. The U.S. producers feel that an unfair advantage is accorded East Asian and Western European manufacturers by their governments in order to sell steel in the U.S. market. The reasons for the alleged subsidization seem clear: the desire for high employment and the need to develop or maintain a heavy industrial base by each country. Such subsidization

raises major questions about U.S. dependence on foreign sources for basic industrial materials.

In the chemicals industry, the United States faces external competition, but of a different type. Chemical manufacturers in the United States already have a large share of the overseas chemicals market. Foreign producers claim that the United States subsidizes chemicals production by artificially keeping feedstock (specifically, natural gas) prices low through controlled prices. As natural gas prices are decontrolled in the United States, the \$12 billion balance-of-payments surplus generated by the chemicals industry in 1981 will be reduced as foreign producers take away foreign markets formerly dominated by the United States.

The paper industry does not appear to face imminent foreign market competition, except perhaps from Canada. Petroleum refining should also be free of competition. In both cases, transportation costs should limit intrusion by foreign producers.

In general, exports of primary industrial commodities are unlikely to sustain U.S. industry growth because developing nations typically emphasize relatively low-technology industries first, making such commodities highly competitive in international trade.

Cost of Capital and Size of Capital Pool

Money to be used for capital expenditures can arise from several different sources. The major sources are debt, equity, and retained earnings. Corporation managers view their money as a resource that could be invested in any of the four project categories (e.g., equipment retrofits) or in some type of revenue-earning account. Any returns from capital investment, in theory, must exceed the interest return of possible bank deposits. The more funds a corporation must borrow from commercial sources to finance its capital projects, the more profitable a project must be.

Corporations derive their funds for capital from a number of internal and external sources. Internal sources include: retained earnings or money

remaining after the costs of production are paid, the delay in paying corporate taxes, and the claiming of tax credits. External sources include borrowing money and paying interest, or equity, and selling ownership (stock) in the company.

Many firms try to maintain a specific debt-equity ratio in order to avail themselves of particular financial sources. If a firm is already at or near its desired debt-equity limit (usually about 35 percent), borrowing ability can be severely constrained. The only way to alleviate this problem would be to issue more stock. However, if the company cannot purchase the stock at an adequate price, because of poor returns, the size of the company capital pool cannot be expanded.

In the steel industry, with its low capital return and its need to finance from debt sources, high interest costs of capital restrict the ability to invest in energy saving or any other kinds of projects. The other three industries also find themselves constrained by the cost of capital, but for them it is but one of the capital allocation decision factors.

Interest rates also impact these industries in other ways. When interest rates are high, consumer sales are restricted; then, consumer goods that use products from the chemicals, steel, and wood products industries do not sell rapidly. Thus, firms may not invest in many technologies that would save energy, either because they do not expect sales volumes large enough to return a profit on the new outlays or because they simply cannot raise the money, no matter how profitable an investment might be. High interest rates also give firms that have traditionally produced primary commodities at least a strong positive incentive to diversify. Diversification can occur by vertical integration downstream into more finished products that generally offer larger profit margins. Also, a firm might engage in an entirely different industry by acquiring another company.

Cost of Materials and Labor

Individual firms in particular industries compete with one another to purchase raw materials and energy at the lowest levels of cost possible, a goal that affects both day-to-day operations and strategic planning. Management can compete by in-

vesting in projects that minimize the cost of production by minimizing labor or by substituting one material for another (or using it more efficiently). Process controls and automation can offer a company significant cost savings through improved quality control—i.e., more efficient use of material—and labor savings. Such changes place more demand on corporation managers to use their employees more productively and often require employee retraining.

From a raw materials standpoint, apart from the price of the raw materials, large and mature companies in the industries discussed also see security of supply as a major problem that could affect both their fiduciary responsibilities and their competitiveness in the marketplace. If, for example, during the time of a fuel embargo, a company has to tell its customers that it cannot supply them because its plants are shut down from lack of energy, it might very well lose those customers forever to a company that can supply them. Therefore, it is not unusual for firms to couple these two factors, price and security of supply, into one strategic decision. For instance, a steel company may choose to own iron ore and coal resources or a paper products company may choose to own forests and timberland.

General Economic Environment and Government Policy

Obviously, management is concerned not only with the immediate environment within its own company and industry, but also within the general economic environment. In the large, multinational firms, this concern has both national and international ramifications. The factors that affect economic outlook are therefore very important to management and vitally affect investment decisions, including the obvious criteria—i.e., interest rates, inflation rates, GNP, and the like.

In the larger corporations, such factors could include international trade agreements, Euro-dollar and Japanese interest rates, and international labor rates. It must also be considered that the international competitor could, in fact, be government owned and subsidized in terms of interest rates, research and developing backing, subsidized pricing of the product, and so forth.

Such backing may be carried out in the “national interest” to the extent that the fiduciary responsibility to operate the company at a profit is greatly diminished.

Government regulations or taxes that unnaturally tip the balance of the marketplace are considered extremely detrimental by industry. For example, if a Btu tax were applied to oil, the non-integrated papermill would be at a severe disadvantage with an integrated papermill because the integrated papermill can use wood waste, black liquor, and other materials to meet its fuel requirements. These resources are unavailable to the nonintegrated mill.

Conversely, pollution legislation that applies equally to all companies can be viewed by industry as a pass-through that does not alter the company's competitive position. However, in today's marketplace, pollution legislation that is applied in the United States, but not equally applied in other industrialized countries, could be considered detrimental to U.S. manufacturers because it upsets the competition balance of the worldwide marketplace.

Finally, the perception of Government policy affects strategic planning. Changing policies, indefinite policies, and policies whose provisions take a long time to effect can play havoc with an industry's strategic planning. For instance, one problem with energy investment tax credits is that it often takes 6 months to 1 year to determine if a project will qualify for the credit. The suggestion heard time and again in case study visits and workshops was to avoid changing policy. With respect to natural gas deregulation, managers said that, by far, the best policy for the Government to pursue was to fix a definite date for deregulation (as has been done) and then to allow sufficient time for the corporation to react to the anticipated price increase.

Levels of Decisionmaking

The responsibility for assessing and minimizing risks falls on all levels throughout the corporation. In most major corporations, those responsibilities are clearly defined. Examples of the provinces of risk decision making are given below. However, it must be emphasized that each in-

dividual corporation would have its own criteria and decision making levels that may be different from those given.

Senior Management

Ensuring the security of energy, material, and labor supplies in a strategic plan is a pivotal aspect of risk reduction for senior management. For example, often the site of a new plant is chosen because of the perception that it will ensure a secure labor or materials supply. In addition, efforts invested in better employee/management relations make a major contribution to risk minimization by avoiding potential strikes in which losses of both profits and wages would be high.

Upper/Middle Management

Upper and middle management play an extremely detailed and comprehensive role in risk management. At this level proposed investments that are compatible with the corporation's strategic plan are reviewed and selected for approval before the commitment of funds is made.

Innovations in new energy-saving processes face a series of hurdles pertaining to risk. One of the greatest of these is skepticism about whether they will actually work as well as they are supposed to. Most companies are reluctant to be the first to try out a new idea. * The manager who accepts an unproven innovation and commits his production line to it reaches for a possible incremental gain on the upside, but may face a total shutdown on the downside. The manager of another mill, who waits to see how his competitor fares, suffers none of the costs of debugging a new idea and generally loses less than a year in catching up if the new idea works. In fast-moving fields like genetics, pharmaceuticals, and computers, a year can be devastating; but in paper, steel, or energy-intensive chemicals, it makes little difference.

*This reluctance on the part of business leaders was recognized by the Energy Research and Development Administration (predecessor to DOE) in 1976. Subsequently, the Office of Industrial Programs within DOE focused its industrial energy conservation program on full-scale demonstrations of new technologies.

Plant Management

The day-to-day operations of risk management and risk planning that affect plant production are usually dealt with by plant management at the corporate and plant engineering levels. In a multiproduct, multi plant company, individual managers know their performance is graded, among other criteria, on the quantity and quality of products produced. An innovation installed on one machine, even when parallel machines are functioning properly, increases a manager's perceived risk. Vendors of process equipment compete not only on price, but also with guarantees of minimum installation time and debugging periods. Furthermore, certain key components (e.g., the recovery boiler in a papermill) have no backup unit, so that something as simple as retrofitting a new combustion sensor could be seen as carrying enormous risk because it jeopardizes the entire unit.

Even in negotiating a new contract with a supplier, the risk of delivery failures and the penalties for such failures are of great concern. To cushion against such risks, some companies hold inventories of raw materials many times the size of inventories of finished products held in the warehouse. The magnitude of possible losses owing to downtime (labor, idle capital, and so forth) warrants this precaution.

Industry managers are also sensitized to regulatory pitfalls that may accompany new technology. A new process or a variation of an old process may come under new Occupational Safety and Health Administration rules, and a new combustion method or new byproduct may require an Environmental Impact Statement. In the recent history of major industries, regulatory requirements have delayed the implementation of certain innovations and cut into profits.

A new technology can best penetrate an industry, therefore, if it has established a record of simple, safe, and rapid installation and startup. Also if the manager can establish checkpoints at which to decide whether to continue with the project, the project stands a better chance of being accepted quickly. The history of process control equipment is an example of this. The steps toward computer control were first to install

stand-alone gauges (in the 1950's), then to add simple analog control systems requiring constant surveillance (in the 1960's), and finally, in the 1970's and 1980's, to introduce fully computerized production lines, including robotics, to replace or augment manual labor.

Elements of a Strategic Plan

The strategic plan that gives rise to investment must, of necessity, incorporate sophisticated methodologies and techniques to analyze risks and attempt to minimize them. Some of these techniques follow.

Time Concepts Within the Strategic Plan

Time considerations not only apply to risk perception, they also play a major role in every facet of the business. Making payroll, paying critical suppliers, repairing critical items of a plant are short-term considerations that fall under the fiduciary responsibility of management. A company must be able to generate the cash to meet its obligations. Obviously, in times when interest rates are high, borrowing money for these purposes can be a critical strain on a company's resources, particularly if sales and profit margins are being eroded. Thus, under some circumstances, even if an excellent long-term investment opportunity arises, it must defer to the short-term obligation. Many energy conservation opportunities are either deferred or not even considered, for just this reason.

A short-term consideration at another level would be the delaying of investments intended to increase future market shares through the modernization and/or expansion of capacity. This decision can have a critical effect on energy efficiency, for the introduction of new technologies associated with modernization and/or increasing capacity invariably lead to increased energy efficiency.

An example of an intermediate-term consideration would be the investment in dual-fired boiler capabilities to protect against and minimize the risks associated with fuel supply interruptions and resultant plant closures. This type of investment would not have a calculable return, for the plant

may never be closed. It is, instead, insurance undertaken purely to meet fiduciary responsibility and reduce risk. Of course, if an interruption does take place, the investment becomes very worthwhile indeed.

Finally, an example of a long-term consideration would be a forest products company buying woodlands or planting trees, or a steel company purchasing iron ore mines and ore-bearing rights. Again, there is a fiduciary responsibility associated with this type of investment, together with the minimization of risk that comes from protecting raw material supplies into the future. However, such long-term investments would take second place to short-term considerations associated with cash flow.

Investment Levels Within the Strategic Plan

Investments can be considered as falling into two broad levels of priorities. In the first level are short-term demands that enable the company to meet its fiduciary responsibilities on a day-to-day basis, for example, meeting payroll. Although these investments can be categorized as “mandatory,” decisions associated with them are still very much part of the strategic plan and involve discrete management judgments. For example, a decision to reduce a skilled labor force or accept a small market share by shedding marginal operations in order to protect cash flow in the short term could seriously jeopardize the company’s growth in the future if its market position improved. The company may not be able to recapture easily the skilled labor force or the market share it lost.

The second level of investments, categorized as “discretionary,” are made after mandatory investments. They are chosen from a list of alternatives and are subjected to various criteria of evaluation, from technical scrutiny to rigorous financial analysis. Investments in energy conservation fall into this category when they are part of the overall strategic plan, most often under the discretionary investments associated with cost cutting.

The importance of cost cutting within a plan depends on the overall economic climate and health of the company. In general, cost cutting

that does not involve capital outlay is always welcome. Energy conservation that often falls in the subcategory of cost cutting is housekeeping.

Cost cutting is usually a very low, if not the lowest, level of priority within the overall plan, particularly when capital outlays are involved. Therefore, Government tax policies—e.g., directed energy investment tax credits that attempt to influence the outcome of industrial investment analysis—only come into play at the lowest level of corporate strategy. The major decisions associated with an investment are based on other aspects which, from management’s point of view, are infinitely more important.

Financial Analysis

All corporations have extremely sophisticated methods for carrying out financial analyses, using certain accepted financial and accounting practices. Each corporation has its own criteria that reflect its basic management style and philosophy. Once a decision to proceed on an investment has been made, a detailed investment analysis, including returns on investment, discounted cash flow, and tax and depreciation implications is undertaken. Although these implications were considered in the formative stages of planning, their specific importance was not quantified in detail until the decision to proceed was made. However, and most important, these implications are not expected to make any material difference to the decision. For example, an energy tax credit on a very small percentage of a multimillion dollar investment would have negligible impact on the decision to undertake the project. A change in depreciation rates that alters cash flow would play a larger role, but again would be unlikely to reverse the decision. However, a large increase in interest rates or a perceived downturn in the market could abort the project immediately.

Any capital investment requires money to be spent at the front and before any revenue stream can be generated from the investment. Because these investments generate returns over long periods of time, methodologies have been developed to calculate accurately the returns on investment, from a project’s conception to the end of its useful life. These methodologies consider

inflation rates, depreciation rates, cost of money, and so forth, and produce calculations that attempt to predict cash flow and the returns on investment over the lifetime of the project.

Methodologies of varying complexity are often used within a corporation when evaluating investments. These methodologies calculate such parameters as simple payback period, net present value, internal rate of return, equivalent rate of return, and profitability index. In choosing which parameter to calculate, corporations reflect both the management style and accounting practices that are compatible with the operation of their business. Each parameter is described briefly below.

SIMPLE PAYBACK PERIOD

The simplest estimate of profitability is obtained by taking the initial capital cost and dividing it by the positive cash flow in the first full year of operation. For typical projects, this gives a number between 1 and 10, which is called the "simple payback period." For example, a \$1.2 million investment which returns \$400,000 per year "pays back" the original investment in 3 years.

NET PRESENT VALUE

When the sophistication of the analysis is increased, two steps are taken. First, the impact of depreciation and taxes are included because after-tax dollars are important factors in determining corporate cash flow. Second, future streams of income are discounted to recognize the greater value of a present over a future dollar.

The effect of the resultant net present value calculation is to produce a number that reflects the dollar value of the specific project to a company, compared to the value of the money used to undertake that same project if that money were invested.

INTERNAL RATE OF RETURN

For most projects where the cash flow is negative at first and positive later, there exists a discount or interest rate such that net present value is zero—e.g., such that the initial capital outlays exactly balance the later profits. The interest rate at that point, called the "internal rate of return"

(IRR), can be looked on as the interest rate at which money is returned to the company for the dollars invested in the capital project.

PROFITABILITY INDEX

One indication of the profitability of a project is made by comparing the capital outlay of money to a project and the revenue stream of money from a project, discounted back to the present. The ratio of the two dollar values is the profitability index.

Comparison of Methods

These sophisticated analysis techniques and the wide variety of capital formation opportunities open to industry are designed both to assess accurately the profitability of the investments and to facilitate their financing. By varying the different parameters, some of the risk involved can be assessed, that is, various interest rates or inflation rates could be examined in order to ascertain the potential vulnerability of the investments to changes in external factors.

The choice of methods used to calculate the value of a capital investment reflects the management style of and within a corporation. It is not unusual for the energy engineering department to assess a project in simple payback terms while the finance department takes the engineering calculations and applies the more sophisticated techniques used by the corporation.

For the purposes of this study, OTA has selected the IRR method for most of its calculations. IRR has the advantage that it lets each project stand alone, unencumbered by the choice of corporate discount rate within any firm. The industry-specific and general investment opportunities discussed in later chapters are evaluated quantitatively using the IRR. The impact of the legislative options on investment decisions concerning specific projects can be seen quite well using the IRR.

The financial assessment is not the final assessment undertaken, however, particularly where major projects are concerned. Sensitivity analysis, which takes into account all other factors—from R&D to final market potential—can also have major impacts on the success of investments,

Sensitivity Analysis and Its Effects

A number of hypothetical investments were carried out by OTA and shown to industrial managers at case study firms in each of the four industries. Upon seeing the results, they cautioned OTA not to take return on investment calculations too seriously. The fact that an initial 10-percent tax credit changed the after-tax IRR by 6 percentage points was not considered persuasive enough to induce investment in a project.

In order to understand this position more fully, further calculations were carried out, incorporating parameters that could be considered uncontrollable by a corporation. This simple sensitivity analysis was applied to a process control system project using five simple variations, including:

1. negotiating a small change in the vendor's contract,
2. incurring unexpected repair costs equivalent to 10 percent of the investment,
3. experiencing a recession during the lifetime of the project,
4. achieving a performance rate of only 90 percent of what was expected, and
5. having prices held down by competition, as shown in table 5.

The results of these analyses, compared to the effect of a 10-percent energy investment tax cred-

Table 5.—Sensitivity Analysis of Internal Rate of Return (IRR) Under Different Scenarios^a for Computer Process Control System

| Condition | After-tax IRR |
|------------------------------------------------|---------------|
| 1. Base Case | 16.4 |
| 2. Vendor escalates service contract | 15.3 |
| 3. Unexpected repair cost in year 4 | 14.8 |
| 4. Recession in midlife of project | 13.1 |
| 5. Profits only 90% of expectations | 12.3 |
| 6. Prices held down by competition | 10.4 |
| 7. Addition of a 10% EITC | 21.5 |

Invariant conditions:

Project: Installation of Computer Process Control System
 Project lifetime = 7 years
 Inflation rate = 6 percent
 10 percent investment tax credit
 ACRS depreciation schedule

SOURCE Office of Technology Assessment

it (EITC), indicate that external factors such as those listed above can have as dramatic an effect on the potential profit derived from a capital project as that of a 10-percent EITC. OTA calculations show that a mild recession can cause a capital project IRR to shift 3 percentage points—i. e., to fall from 16.4 to 13.1 percent. On the other hand, a 10-percent EITC would cause the IRR to shift upward by only 5 points; for example, from 16.4 to **21.5** percent, which may in part explain why aversion of risk and anticipated energy prices drive project decisionmaking more than do tax credits and other Government policies.

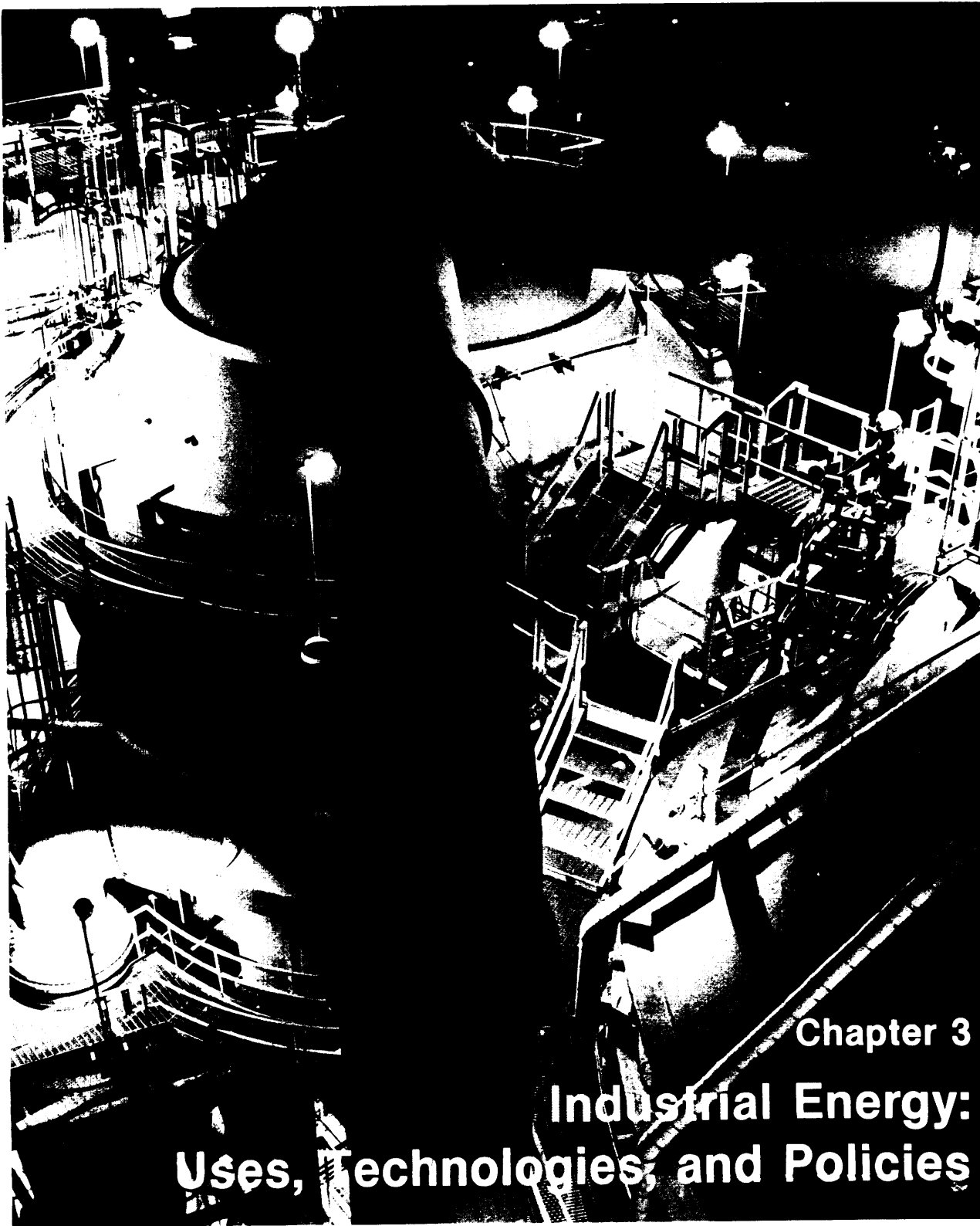

Chapter 3
Industrial Energy:
Uses, Technologies, and Policies

Photo credit: PPG Industries

Contents

| | <i>Page</i> |
|---------------------------------------------------------------|-------------|
| Industrial Energy..... | 37 |
| Sources of Industrial Energy..... | 37 |
| Energy Costs..... | 37 |
| Characteristics of Industrial Energy Use..... | 39 |
| Determinants of Industrial Energy Use..... | 40 |
| Qualitative Characteristics of Energy Use..... | 41 |
| Quantitative Energy Use Characteristics..... | 43 |
| Variability of Energy Intensiveness..... | 45 |
| End-Use Profile..... | 45 |
| Trends in Energy Use Per Unit of Output..... | 46 |
| Industrial Energy-Related Technologies and Processes..... | 48 |
| Housekeeping..... | 48 |
| Retrofitting..... | 48 |
| Computer Control Systems..... | 48 |
| Waste Heat Recovery..... | 49 |
| Electric Motors..... | 50 |
| Fuel Switching..... | 50 |
| Policies That Affect Industrial Energy Use..... | 53 |
| Existing U.S. Industry Energy-Related Legislation..... | 53 |
| The Industrial Energy Conservation Program..... | 58 |
| Foreign Industrial Energy Use and Policy..... | 58 |
| National Programs To Spur Industrial Energy Conservation..... | 60 |
| Implications for the United States..... | 61 |

TABLES

| <i>Table No.</i> | <i>Page</i> |
|--------------------------------------------------------------------------------------------------------------------------------|-------------|
| 6. U.S. Industrial Energy Use by Source..... | 38 |
| 7. Industrial Energy Use by Division..... | 44 |
| 8. Distribution of Purchased Energy for Heat and Power of Output by Selected industry Group in U.S. Manufacturing 1979..... | 45 |
| 9. Estimated Distribution of U.S. Industrial Energy Use, by Energy Service, 1978 ..46 | 46 |
| 10. Industrial Energy and Oil Use by Representative IEA Countries 1973 and 1979,.. | 59 |
| 11. Comparative Energy Efficiencies-of Industrial Processes unrepresentative IEA 'countries.....***.....***..... | 59 |
| 12. Changes in industrial Energy Consumption in IEA Countries between 1973 and 1978..... | 60 |
| 13. Projected Trends of industrial Energy and Oil Use in Selected IEA Countries Through 1990..... | 60 |

FIGURES

| <i>Figure No.</i> | <i>Page</i> |
|-----------------------------------------------------------------------------------|-------------|
| 7. Industrial Energy Demand, 1950-81.....*...***.....** * *** **** | 38 |
| 8. Industrial Energy Prices, 1970-81..... | 39 |
| 9. Overall Age Distribution of Equipment in the Manufacturing Industry, 1975..... | 41 |
| 10. Energy Trends in Industry, 1972-81..... | 44 |

Industrial Energy: Uses, Technologies, and Policies

INDUSTRIAL ENERGY

Energy does not flow through the industrial sector in simple or direct ways. Some energy or energy-bearing materials are recycled and reused. Substantial portions of energy used are derived from unusual sources. Some materials are processed in ways that yield both energy and feedstock value. Finally, some energy materials are not used at all for energy purposes. Thus, conceptual and data collection problems arise in defining and measuring the energy used by the industrial sector.¹

Sources of Industrial Energy

In the industrial sector, petroleum is the dominant energy source for motor-driven mechanical equipment of agriculture and construction. Natural gas is the dominant energy source in mining because of its availability in the relatively remote operations of the oil and gas extraction industry. Natural gas is used in manufacturing because it burns cleanly and provides easy flame control. It has also been used as a feedstock and as fuel for the special needs of a number of processes, such as glass manufacture and some ceramic production processes.

The use of petroleum and coal as raw materials accounts for about half of the manufacturing use of each of these fuels. * Most of the remaining half of petroleum use in manufacturing is for direct heat or for steam generation. This is also true for coal, but coal is used more for steam generation because there are relatively few goods produced using direct heat that can tolerate the impurities emitted by burning coal. For some energy uses,

particularly for large boilers (for water heating or steam production), coal, oil, and gas are easily interchangeable in a technical, if not economical, sense. Many facilities, in fact, have dual or even triple fuel capabilities—with oil and natural gas the most likely combination.

As with other energy use variables, the diversity of use of various energy sources is more striking at lower levels of aggregation. Table 6, which shows energy use by source for the divisions, also has data for three selected industries in the manufacturing and mining divisions. Papermills, with a wide distribution of purchased energy source use, contrast with steel, which is heavily dependent on coal and coke, and the chemicals industry, which uses large quantities of natural gas and electricity. Overall industrial energy use from 1950 to 1980 is shown in figure 7.

Energy Costs

Although the use of energy in industry is a major contributor to the character of modern economies, the share of energy in the total cost of producing goods is relatively small. In manufacturing, for example, purchased energy (fuels and electricity) accounted for only 7.5 percent of gross product in 1979, even after the steep energy price increases of the 1970's. Given the variability of energy intensiveness across industries, the relative share of energy in total production costs is much higher in the more energy-intensive industries. Thus, the cost of purchased energy equaled 23 percent of the cement industry's value of shipments in 1979, 14 percent of the paperboard industry's value of shipments, and 25 to 30 percent of those for steel mills.

The degree of the energy price increases of the 1970's should not be understated. Prior to the early 1970's, manufacturers' energy costs rose moderately in nominal terms and actually fell relative to inflation. Between 1970 and 1979, however, the average real cost of fuels and electricity purchased by manufacturers increased from

¹Substantial parts of the discussion concerning the definition, measurement, and determinants of industrial energy use are based on material in the following: John G. Myers, et al., *Energy Consumption in Manufacturing* (Cambridge, Mass.: Ballinger Publishing Co., 1974); John G. Myers and Leonard Nakamura, *Saving Energy in Manufacturing: The Post-Embargo Period* (Cambridge, Mass.: Ballinger Publishing Co., 1978), and Bernard A. Gelb and Jeffrey Pliskin, *Energy Use in Mining: Patterns and Prospects* (Cambridge, Mass.: Ballinger Publishing Co., 1979).

*Metallurgical coal that is converted to coke is counted as a raw material.

Table 6.—U.S. Industrial Energy Use by Source (quadrillion Btu)

| Energy source | Entire industrial sector, 1981 | Sector divisions, 1979 ^a | | | | Selected industries, 1979 ^b | | |
|----------------------------------------------|--------------------------------|-------------------------------------|--------|--------------|---------------|----------------------------------------|----------------|--------------------|
| | | Agriculture | Mining | Construction | Manufacturing | Papermills | Steel industry | Chemicals industry |
| Coal and coke | 3.12 | (c) | 0.10 | (c) | 3.69 | 0.18 | 1.91 | 0.31 |
| Natural gas | 8.12 | 0.17 | 1.70 | (c) | 6.67 | 0.41 | 0.64 | 1.37 |
| Petroleum | 8.12 | 1.32 | 0.62 | 1.58 | 6.68 | 0.41 | 0.21 | 0.76 |
| Purchased electricity at 3,412 Btu/kWh | 2.85 | 0.13 | 0.26 | 0.02 | 2.50 | 0.15 | 0.17 | 1.00 |
| Total | 22.21 | 1.62 | 2.68 | 1.60 | 19.54 | 1.15 | 2.93 | 3.44 |

NOTE: Recent revisions of petroleum and natural gas use data by DOE have been substantial, and make it difficult to reconcile DOE figures with figures published by the Bureau of the Census for manufacturing and mining.

^aEstimated.
^bpurchased energy only.
^cNone, or less than 5 trillion Btu.

SOURCE: Energy Information Administration, U.S. Department of Energy, *Monthly Energy Review*, March 1982; *End Use Energy consumption Data Base: Series 1, Tables*, June 1978; Economics, Statistics, and Cooperative Service, U.S. Department of Agriculture, *Energy and U.S. Agriculture: 1974 and 1978*, April 1980; Bureau of the Census, U.S. Department of Commerce, *1979 Annual Survey of Manufactures and 1977 census of Mineral Industries*; American Iron and Steel Institute, *Annual Statistical Report for 1960*; Chemical Manufacturing Association, "1980 Report to the Office of Industrial Programs, Department of Energy."

Figure 7.—industrial Energy Use, 1950-81

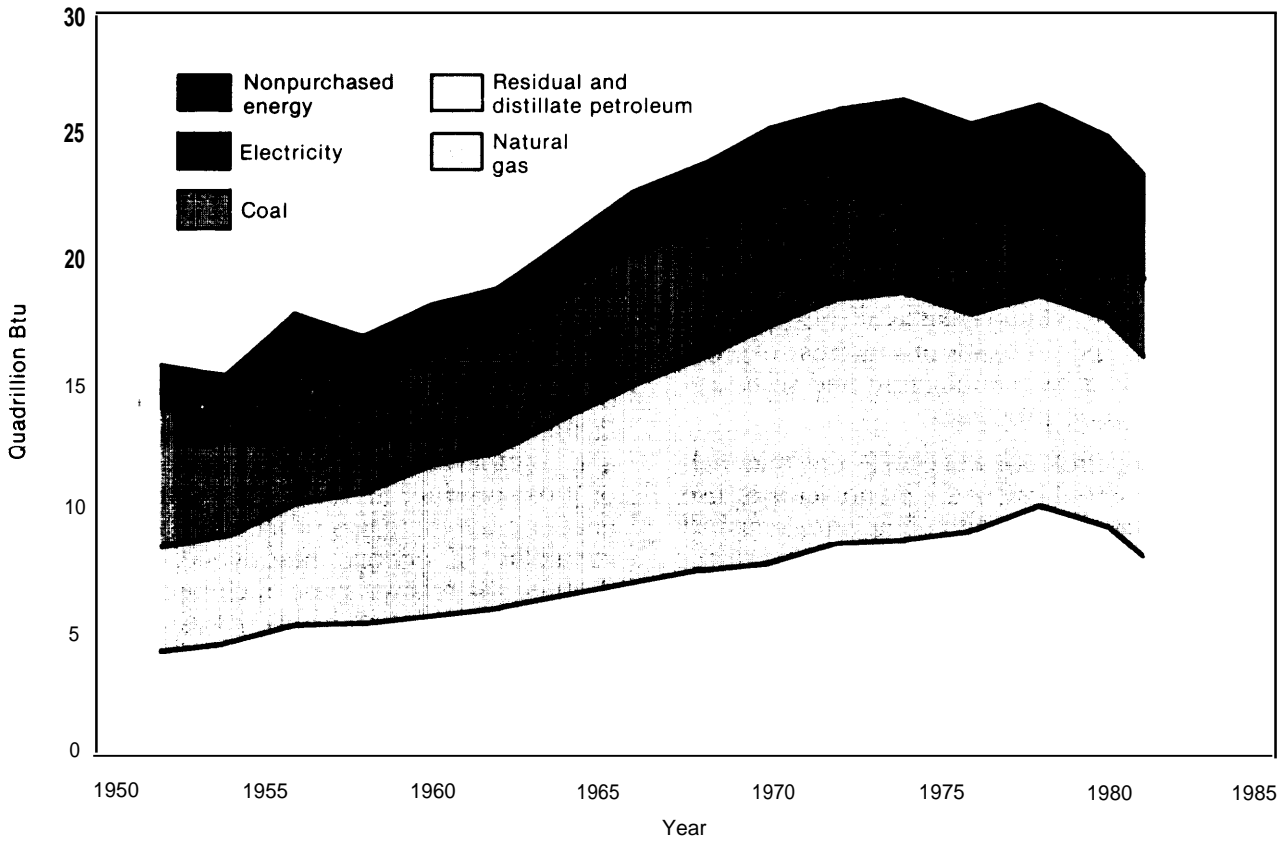

SOURCE: Energy Information Administration

\$2.34 to \$4.44 per million Btu (see fig. 8). The cost per million Btu of distillate oil jumped from \$1.76 to \$5.31, and that for natural gas increased from \$0.63 to \$1.76. Despite this dramatic increase in energy prices, the mix of energy sources

used by manufacturers continued its pre-1971 trend toward more expensive energy sources (oil and electricity) and away from coal, at least until 1979.

Figure 8.—Industrial Energy Prices, 1970-81

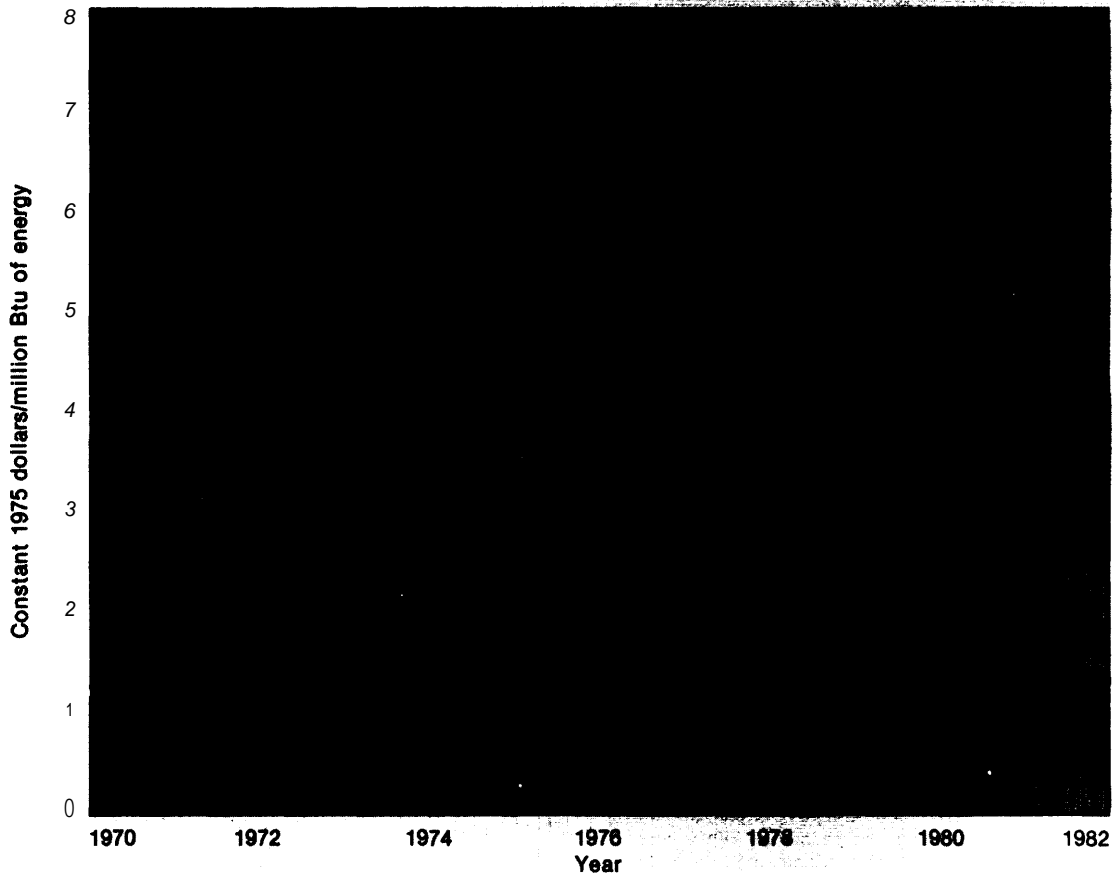

SOURCE: Energy Information Administration.

CHARACTERISTICS OF INDUSTRIAL ENERGY USE

The manner of accounting for energy use in this report is defined as the attribution to industry (or its divisions) of the energy that is applied or converted to nonenergy products. This is the so-called disappearance approach. As a consequence of the way in which energy use and re-

lated data are collected, what is actually measured and reported is the quantity of fuels and electricity purchased by the industrial sector that does not leave the sector as fuel or electricity. This approach has the disadvantage of excluding from energy use the process byproducts and

waste materials that are consumed for their heat value. * It also excludes utility generation and transmission losses.

If defined to exclude utility generation and transmission losses, industrial energy use directly reflects changes in technology, product mix, and other developments in a sector or industry. On the other hand, distortions result from this method if the sector or industry generates part of its electricity internally and the proportion of internally generated electricity changes over time. For example, a decrease in the proportion of electricity that is self-generated will "shift" the heat losses from industry to the electric utility sector, causing an apparent decline in Btu consumed per unit of output, even if industrial energy efficiency has been unchanged.**

The analytic focus of this chapter is on final rather than primary energy use. Mainly for this reason, energy use by the industrial sector has been defined to equal the direct heat content of fuels and purchased electricity used plus the heat equivalent of the energy materials used for non-energy (feedstock) purposes.*** Energy materials

*An approach that avoids the above disadvantage is to measure the energy content of all materials and electricity taken in by the sector or industry and to subtract from it the energy contained in all products shipped. Since this entails the enormous task of determining the energy content of each of the millions of commodity input and output flows, this method has not been used herein.

* *The choice between the measures of heat value of purchased electricity is particularly important for the industrial sector because the proportion of electricity used that is self-generated can be significant for the sector as a whole and appreciable for some industries. For instance, more than 46 percent of the electric power used by paper and paperboard mills (excluding building paper) in 1979 was self-generated. However, for industry as a whole, the self-generated electricity share has decreased markedly. While such self-generated electric power accounted for 21 percent of electricity used in manufacturing establishments in 1958, it was only 9 percent in 1979. Appropriateness of measurement method hinges on purpose of analysis, the particular industry group under examination, and the level of disaggregation. Correct analytical treatment of electrical generation heat losses will become more critical if there is rapid growth of cogeneration. This is true whether the electric power is used by the industrial plant or is sold to a utility.

* * *Use of the narrower definition of the energy content of purchased electricity has another analytical advantage for the present purpose. While the overall measure of energy in purchased electricity is helpful in indicating the total impact of a sector or industry on the total demand for energy in the economy, it is not a good indicator of the effects on energy use brought about by changes within the sector or industry. This is because changes in the amount of heat used by external electric utilities to generate each unit of electricity are incorporated into the energy use totals of the sector or industry. Average thermal efficiency of electric utilities improved by nearly one-third between 1947 and 1967, fell a little from 1967 to 1971, and has since risen slightly, but irregularly.

used for feedstock represent as much a demand for energy resources as do energy materials used for heat or power. The energy value of purchased electricity is calculated to be its theoretically contained energy—3,412 Btu/kilowatt-hour (kWh)—rather than the total amount of energy used in generating and delivering the electricity, which is more than three times that number of Btu/kWh.

Self-generation, it should be noted, is a broad term denoting the generation of electricity by an industrial plant whose primary activity is not the production of electric power. Such self-generation may or may not constitute part of a **cogeneration** operation, in which the energy in the steam used for electricity generation is also used to meet (entirely or partially) one or more other energy needs. Cogeneration can mean the complete use of all the energy within the plant, or the sale of some of the energy or one of the energy forms to an electric utility or an energy end user.

Determinants of Industrial Energy Use

The total amount of energy used in industry at any one time depends on the level and composition of demand for the products of industry, the relative price of energy, the quantities of capital equipment available for use, the level of technology, Government regulations, and the cost of equipment for improving energy efficiency. Changes in any of these variables will influence the amount of energy used.

Analyzing the determinants individually (i.e., holding the others constant) the following observations have been made:

- **Product demand:** In the short run, total energy use generally increases when demand rises and more goods are produced. Since the production of every kind of industrial commodity requires some energy, only a shift in the composition of demand (product mix) to less energy-intensive commodities can prevent energy use from increasing when output increases. Such product mix changes can result from changes in the economy. For example, there is evidence that in recent years the sharp increase in the price of energy has reduced the demand for energy-intensive products and slowed the

growth of energy-intensive manufacturing industries.

- **Relative price of energy:** In production, those processes that use less energy for making a commodity become more economical and attractive when the relative price of energy increases. Another way to reduce energy losses is by instituting more careful housekeeping.
- **Use of capital equipment:** Energy use over the long term can be affected by an increase in the amount of capital equipment. For example, a change from a labor-intensive process to one that is highly mechanical can increase energy consumption. However, capital can be substituted for energy, such as when a furnace or steam pipe is insulated.
- **Level of technology:** An improvement in technology results in a decrease in the amount of one or more inputs needed to produce the same amount of output (holding other factors constant). While energy frequently is one of the inputs reduced, sometimes its use will rise as a result of a technological change. For instance, a new process may economize on labor, yet consume more energy.
- **Government regulations:** Energy use can be affected by Government regulations, particularly those aimed at protecting the environment or worker safety and health. In most cases, additional procedures are required, such as processing of wastes and instituting work area security measures, that entail the use of energy.
- **Cost of equipment for improving energy efficiency:** The cost of equipment for improving energy efficiency can have a direct impact on energy use within an industry. A piece of equipment may return many dollars in savings via decreased energy costs; but if the initial investment is very expensive, the corporation may not have the funds to undertake such a project.

Qualitative Characteristics of Energy Use

Capital Intensiveness

Energy use in any sector is related to the available stock of capital equipment in use. While

energy intensiveness is not solely a function of capital intensiveness, the connection is strong. When data on capital equipment per person employed are compared with figures on energy use per unit of output, divisions and industry groups that have high ratios of capital to labor appear to be those with high energy intensity. z

In "capital-dominated" industries, increases in overall productivity (which normally means reduced energy intensity) are most likely to come from additions of new equipment or processes.³ However, because the initial cost of capital equipment is high and the average useful life of capital ranges from 5 to as many as 50 years, replacement of equipment is slow (see fig. 9). This fact limits the rate at which new equipment with dif-

²John W. Kendrick and Elliot S. Grossman, *Productivity in the United States, Trends and Cycles* (Baltimore: The Johns Hopkins University Press, 1980).

³Bela Gold, *Productivity, Technology, and Capital* (Lexington, Mass.: D.C. Heath & Co., 1979), pp.98-100.

Figure 9.—Overall Age Distribution of Equipment in the Manufacturing Industry, 1975

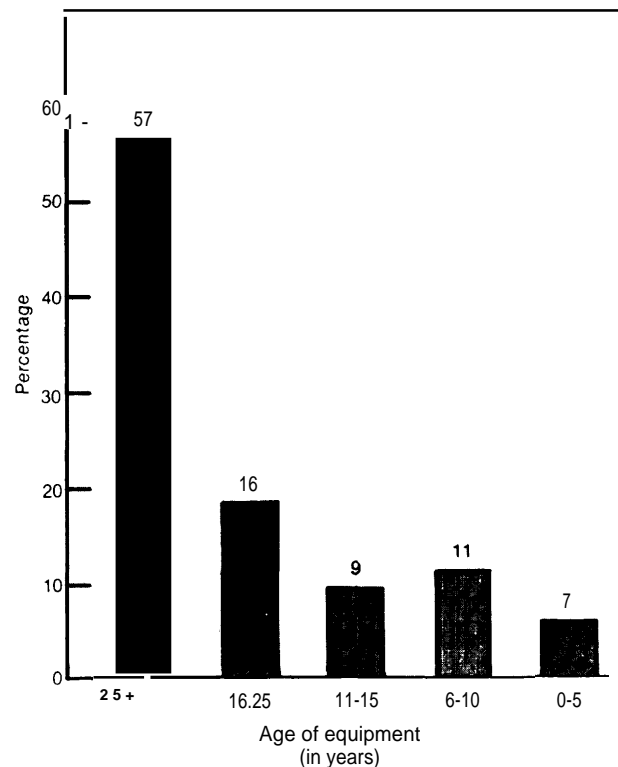

SOURCE: John Govoni and Cyr Livonis, "Age of Manufacturing Plants," *Joint Statistical Meetings*, San Diego, Calif., August 1978.

ferent energy-use characteristics can be adopted by industry.

In some cases, improved raw materials result in improved productivity in capital-dominated industries. A notable example is the steel industry, where the use of pelletized iron ore (produced in the mining division) has decreased coke and heat energy requirements.

Process-Specific Technologies

The processes employed in the output of industrial products are many and diverse. Each of the many industrial substances handled and transformed requires a process suitable to the location of the industrial activity and the commodity's physical state, chemical composition, and final use. For example, some furnaces in the steel industry are used to melt materials to permit further processing, whereas furnaces in brick manufacture are used to harden the product. Because technological change in one process often has little or no applicability to other processes, the rate at which changes in industrial energy use can occur is limited.

Raw Material Use

In its role as the goods-producing part of the economy, the industrial sector uses large quantities of energy materials primarily, if not exclusively, as feedstocks for products that are not intended for energy purposes. This situation is unique among the major energy-using sectors. The energy materials used as feedstocks by the industrial sector in 1979 had a heat value of nearly 6 Quads, roughly one-fourth of the total industrial energy use.

The use of energy materials for feedstocks is concentrated in manufacturing and construction. Most of such feedstock materials are petroleum products and natural gas. Petroleum-based feedstocks are used mainly in the petrochemical industry—e.g., for industrial organic chemicals and in construction asphalt. Natural gas is a major feedstock for ammonia and fertilizer manufacture.

Most of the substantial amount of coal purchased by the steel industry is classified as a

feedstock by the Bureau of the Census because it is processed to produce coke and other byproducts. Coke is essential to the chemical change that occurs when iron ore is changed to molten iron, and it is a source of the necessary heat. In 1981, metallurgical coal with a heat value of approximately 1.4 Quads was converted into coke.

Use of Captive Energy

A significant proportion of energy used for heat or power by the industrial sector is derived from waste materials or byproducts generated by industrial processes. Examples are exothermic heat generated in chemical reactions, the production of coke oven and blast furnace gases in the steel industry, and the combustion of waste wood in the paper industry.

The energy content of the used "captive" energy may or may not be counted in Department of Energy (DOE) or Census Bureau compilations, depending on the type of energy source. For example, where the energy source is a petroleum product, its full heat value has already been counted by DOE, but not by the Census Bureau in its quinquennial *Census of Manufactures* or the *Annual Survey of Manufactures* reports. If the source is not a conventional industrial energy source (e.g., wood wastes in a papermill), the heat value of the used captive energy is counted by neither DOE nor the Census Bureau. In the first case, the demand for energy sources is known, but there is no information on the part that went for heat or power rather than for incorporation into a product. In the second case, there is no reflection in overall energy use data of this portion of energy use in the economy, even though its existence has an effect on the amount of "conventional" energy consumed. In both cases, some information is missing that would assist analysts in learning about the manner, efficiency, and extent of both conventional and unconventional energy use.

Shifts in Energy Use Between Sectors

Changes in the relative prices of goods and services over time affect the location of energy use in the economy. Such changes can result even if there has been no change in the composi-

tion of demand. Awareness of energy displacement is important to avoid incorrect conclusions about energy conservation in an industry, division, or sector. Many such shifts have occurred. For example, a shift to the mixing of concrete by suppliers, as opposed to builders, has resulted in a shift in energy use from the construction to manufacturing (the ready-mix concrete industry). Rapid growth in fertilizer and pesticide use by agriculture has increased farmers' output relative to energy input, but has added substantially to total energy use in manufacturing. Finally, the expansion of the frozen food industry in manufacturing has decreased the amount of energy used for food preparation in the residential sector. Awareness of such shifts is crucial to proper interpretation of industrial energy use figures.

Capital Effects and Capacity Utilization

Energy use per unit of output is generally high when the level of production is low. One reason for this is simply the need, at reduced levels of output, to reheat furnaces, ovens, or boilers that have been allowed to cool during exceptionally slack periods. The steel industry provides an especially good example of this effect. During the recession years of 1970 and 1975, energy use per ton of raw steel produced rose 6 and 10 percent respectively.

An exception to this effect is found in industries where plants can be partially or completely shut down if there is a decline in demand and when it is feasible to shut down the least efficient facilities. Such a situation requires a homogeneous product and a comparatively small number of firms in the industry. A

Quantitative Energy Use Characteristics

Overall Sector Consumption

Energy directly used by the industrial sector for heat, power, and feedstocks accounts for almost one-third of the total energy used in the United States. In 1981, the heat value of such direct

⁴This discussion of cyclical effects is based on material in J. G. Myers, et al., *Energy Consumption in Manufacturing* (Cambridge, Mass.: Ballinger Publishing Co., 1974); and J. G. Myers and L. Nakamura, *Saving Energy in Manufacturing* (Cambridge, Mass.: Ballinger Publishing Co., 1978).

energy use totaled 25 Quads, or 30 percent of the economywide aggregate of 73.8 Quads.

In contrast to the other broad, energy-using sectors, direct energy use by industry has decreased from 40 percent of the U.S. total in 1947, to 30 percent in 1981. This decline was due partly to the decline in the share of the gross national product (GNP) accounted for by the sector.

As shown in figure 10, extrapolating historical trends prior to 1972 would lead to an estimate of 40 Quads of energy use for 1981. However, actual energy use in 1981 was only slightly higher (29 Quads) than in 1972. DOE analysis indicates that a slower growing economy accounted for 4.4 Quads of this difference: the economy went from an annual GNP growth rate of 4.0 percent in 1972 to 2.6 percent in 1981. In addition, the United States now uses a slate of industrial products different from that used in 1972. For example, consumers drive more fuel-efficient automobiles, made of less steel and less petroleum-based plastics. Moreover, U.S. production is now greater in areas such as computers and biotechnology and less in steel production and petroleum refining. This market-induced phenomenon is due, in part, to perceived or anticipated rising energy prices and also to expanding markets in these new areas.

In addition, there is a historical trend toward even more energy-efficient production facilities. Even when energy costs were stable or declining, industrial managers had significant reason to make efforts to conserve energy. Moreover, as manufacturing technology continues to evolve, it becomes more energy efficient. Between 1972 and 1981, the 2.3 Quads of energy saved because of new technology would have been saved even if prices had not increased since 1972,

Finally, 1.1 Quads of energy were saved because of efficiency improvements made specifically to existing equipment to counteract the quadrupling of energy prices since 1972.

Energy Use by Divisions

Energy use by the industrial sector is not proportional to the relative sizes of the divisions in dollar value of output. Just as the divisions are

Figure 10.—Energy Trends in Industry, 1972-81

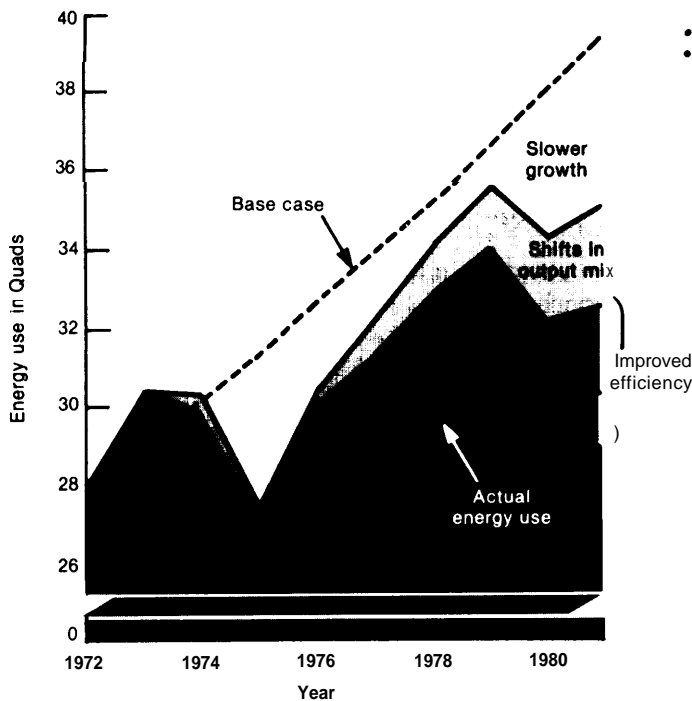

- Energy use in 1981 was down 10.4 Quads from the base case.
- These energy savings (26%) result from several factors:
 - Slower growth (4.4 Quads) —Industrial output slowed from 4.4% per year to 2.6% per year after 1972;
 - Shifts in output mix(2.6 Quads) —depressed output among large, energy-using industries (steel, cement, chemicals, aluminum, paper) is offset by increased growth in lighter manufacturing (textiles, fabrication of aircraft and machinery parts, computers, and food processing);
 - /reproved energy efficiency(3.4 Quads)—new technologies and better energy management. Part is due to the historical trends (2.3 Quads) in improving energy efficiency associated with capacity expansion and capital stock turnover; the remainder is due to accelerated gains(1.1 Quad) in improved efficiency associated with higher energy prices.

SOURCE: R. Marlay, Off Ice of Planning and Analysis, U.S. Department of Energy. Analysis based on data from the Board of Governors of the Federal Reserve System, the U.S. Department of Commerce, the Energy Information Administration, and on "Industrial Energy Productivity, 1954 -1980," Massachusetts Institute of Technology, Cambridge, Mass.

diverse, so are the activities and products within each division. The bulk of industry's energy use takes place in manufacturing—the largest division in output. Direct energy use in manufacturing totaled an estimated 19.5 Quads in 1979, or 75 percent of the total for the industrial sector (see table 7). Gross product originating in manufacturing was 76 percent of industrial sector gross product (in 1972 dollars) that same year.

Almost half of the rest of the energy used by industry is accounted for by mining, but mining's share of the sector total is disproportionate to its output. Estimated energy use in mining was 2.7 Quads in 1979, while gross product originating in mining accounted for only 4 percent of the industrial sector's total. Agriculture and construction each used about 1.6 Quads in 1979, or 6 percent each, of total industrial energy use. These divisions' respective shares of sector gross product originating were 8 and 12 percent. The different proportions between energy use and out-

Table 7.—Industrial Energy Use by Division (in quadrillion Btu)

| Division | 1954 | 1967 | 1972 | 1979 |
|------------------------|-------|-------|-------|-------|
| Agriculture. | 0.90 | 1.40 | 1.61 | 1.63 |
| Mining | 1.27 | 1.78 | 1.99 | 2.68 |
| Construction | 0.82 | 1.24 | 1.60 | 1.60 |
| Manufacturing. | 11.78 | 17.62 | 19.76 | 19.54 |
| Total | 14.77 | 22.04 | 24.96 | 25.45 |

NOTES: The energy value of purchased electricity is defined hereto be the theoretically contained energy of the delivered electricity—that is 3,412 Btu/kWh.

The data shown are estimates and include energy substances used as raw materials. Recent revisions by DOE of energy consumption data have been substantial and make it difficult to reconcile DOE figures on energy use with figures published by the Bureau of the Census for manufacturing.

SOURCES: Bernard A. Gelb and Jeffrey Pliskin, *Energy Use in Mining: Patterns and Prospects*, Cambridge, Mass., 1979; John G. Myers, *Industrial Energy Demand, 1976-2000*, draft report prepared for the General Accounting Office, July 31, 1979; Economics, Statistics, and Cooperative Service, U.S. Department of Agriculture, *Energy and U.S. Agriculture: 1974 and 1978*, Washington, D. C., 1980; Tetra Tech, inc., *Energy Use in the Contract Construction Industry*, prepared for the Federal Energy Administration, Feb. 18, 1975; Bureau of the Census, U.S. Department of Commerce, 1977 *Census of Mineral Industries, "Fuels and Electric Energy Consumed,"* February 1981; Energy Information Administration, U.S. Department of Energy, *End Use Energy Consumption Data Base: Series 1 Tables*, Washington, D. C., 1978; Energy information Administration, 1981 *Annual Report to Congress*, Washington, D. C., 1982; Bureau of Mines, U.S. Department of the Interior, *Minerals Yearbook*, several issues, Washington, D. C.; Bureau of Mines, *Energy Through the Year 2000*, Washington, D. C., 1972.

put reflect large differences in energy use per unit of output among divisions.

Much more is known about energy use in manufacturing and mining than in agriculture and construction because of the availability of detailed industry data over an extended time period from the quinquennial *Census of Manufactures* and from the Bureau of Mines industry surveys and *Minerals Yearbook*. In recent years, the *Annual Survey of Manufactures* has provided yearly figures on energy use in manufacturing.

Variability of Energy Intensiveness

The energy used per unit of product varies markedly among divisions and industries. Examples of high energy use in relation to output can be found in the following industry groups: primary metals, chemicals, petroleum and coal products, and paper and allied products. Purchased energy use per unit of output by these groups ranged from 39,000 to 57,000 Btu per dollar of value added in 1979, compared with 17,000 Btu for all of manufacturing (see table 8). Together, the five groups accounted for approximately 65 percent of manufacturing's purchased energy for heat and power in 1979, as against 26 percent of manufacturing, valued added.

In sharp contrast, the following four groups together accounted for 40 percent of manufacturing, value added, but only 11 percent of energy use: nonelectrical machinery, transportation equipment, electric and electronic equipment, and fabricated metal products. Energy use per dollar of value added by these groups ranged from 3,400 Btu to less than 6,700 Btu.

Greater differences in energy intensity can be seen at the lowest basis of aggregation—the individual industry (four-digit SIC level). For example, in 1979 purchased Btu (for heat and power) per dollar of value added ranged as high as 332,000 Btu for the lime industry to as low as 5,000 Btu for the motor vehicles and car bodies industry. These differences in energy intensity are important for evaluating prospects for reduced energy use in the economy by virtue of shifts in product mix.

End-Use Profile

Attesting to its diversity, industry uses energy for probably a wider variety of purposes than does any other sector of the economy. Estimates, updated for this report, by the Energy Information Administration (EIA) and other organizations indicate that each of seven different types of energy service account for at least 2 percent of sector use⁵(see table 9).

The most energy-intensive industrial processes entail the direct application of heat to break and rearrange atomic bonds through chemical reactions. Since processes such as smelting, ore beneficiation, cement manufacture, and petroleum refining typically involve large amounts of such

⁵Energy Information Administration (EIA), Department of Energy, *End Use Energy Consumption Data Base: Series 1 Tables* (Springfield, Va.: National Technical Information Service, June 1976), p. 206.

In preparing its data on energy consumption by end use, EIA used only explicit published figures, and made few, if any, estimates. As a result, large quantities of energy use were not categorized by end use, but designated as "other." The Congressional Research Service has used additional related information to categorize most of this use in the case of the industrial sector.

Table 8.—Distribution of Purchased Energy for Heat and Power of Output by Selected Industry Group in U.S. Manufacturing, 1979

| Industry group | Energy used | | Value added | | Energy used per dollar of value added (thousand Btu) |
|-------------------------------------------|----------------|--------------|--------------|--------------|------------------------------------------------------|
| | (Trillion Btu) | (% of total) | (\$ billion) | (% of total) | |
| Paper and allied products | 1,300 | 10.1 | 29.7 | 3.8 | 43.8 |
| Chemical and allied products | 2,889 | 22.5 | 73.4 | 9.5 | 39.4 |
| Petroleum and coal products | 1,245 | 9.7 | 24.8 | 3.2 | 50.1 |
| Stone, clay, and glass products | 1,266 | 9.8 | 24.1 | 3.1 | 52.6 |
| Primary metals | 2,689 | 20.9 | 47.6 | 6.2 | 56.5 |
| Total manufacturing | 12,869 | 100.0 | 772.6 | 100.0 | 16.7 |

NOTES See note to table 7 regarding energy content of purchased electricity. Percentages were calculated from unrounded numbers.

SOURCE: U.S. Bureau of the Census, 1979 *Annual Survey of Manufactures*.

Table 9.—Estimated Distribution of U.S. Industrial Energy Use, by Energy Service, 1978 (percent)

| Energy service | Manufacturing | Entire sector |
|---------------------------------|---------------|---------------|
| Space conditioning | 2 | 2 |
| Direct heat | 30 | 26 |
| Machine drive | 5 | 13 |
| Vehicles ^b | 2 | 8 |
| Steam | 22 | 16 |
| Electrolytic process | 5 | 4 |
| Raw material | 30 | 27 |
| Other ^c | 5 | 4 |
| Total | 100 | 100 |

^aIncludes space heating and cooling, light, water heating, and refrigeration.
^bOff highway.

^cIn some cases where no amounts are shown, the small quantities of energy use accounted for by particular energy services have been included in "other."

SOURCES: Energy Information Administration, U.S. Department of Energy, *End Use Energy Consumption Data Base: Series 1 Tables* (Springfield, Va.: National Technical Information Service, June 1978); Solar Energy Research Institute, *Building a Sustainable Energy Future*, vol. 2, published by the U.S. Congress, House Committee on Energy and Commerce, April 1981, estimates by the author.

heat, it is not surprising that more than one-fourth of industrial energy use is accounted for by direct heat applications. Because steam is another source of heat, most notably in the manufacture of paper and chemicals, this energy service represents another one-sixth of industrial energy use. Thus, heat of some sort accounts for nearly half of total industrial energy applications. When energy sources used for feedstocks (more than one-fourth of the total) are subtracted, direct heat and steam account for nearly three-fifths of industrial end-use energy demand. Using energy to provide fuel and electrical power for machinery and vehicles is predominant in agriculture, construction, and mining, where it accounts for an estimated 86, 45, and 57 percent, respectively, of energy use in those divisions.

Trends in Energy Use Per Unit of Output

Overall industrial energy use per unit of output has decreased steadily since the late 1940's, including both before and after the Arab oil embargo of 1973-74.

Post-World War II to 1972

Between 1947 and 1972, energy use per dollar of real gross product in the industrial sector fell an average of 1.1 percent per year. Also, use of energy per unit of output in manufacturing decreased an average of 0.8 percent per year be-

tween 1954 and 1972. Most of this decline was traced to: 1) faster energy saving by the energy-intensive manufacturing industry groups compared to other manufacturing industries, and 2) faster output growth by the less energy-intensive industries. Among the energy-intensive manufacturing industry groups, the 8 or 10 largest users (which accounted for half of manufacturing energy use) reduced their energy use per unit of output faster than did the remaining energy-intensive industries.

Within manufacturing, declines in energy-output ratios were the net result of a number of opposing influences. Probably most important was the introduction of new technology that permitted an industry to produce a given volume of product with a smaller quantity of capital, labor, energy, and materials. The introduction of new technology nearly always entailed new or expanded manufacturing facilities. In some cases, improved raw materials aided overall productivity. Labor and energy were frequently the inputs that were economized.

Improvements in management techniques also contributed to the decreases in energy consumption per unit of output. However, such managerial and technological developments were largely incidental to innovations designed primarily to enhance overall productivity. Finally, the shift in production from energy-intensive industries toward those that were less energy-intensive also contributed to the decline in the energy-output ratio for all manufacturing. The former are mainly basic material industries; thus, this shift is part of the long-term development toward higher degrees of fabrication.

In contrast, energy use per unit of output in manufacturing was boosted by an acceleration in the late 1960's in the growth of industries using large amounts of energy-bearing commodities for raw materials—particularly petrochemical feedstocks and natural gas. Such industries included plastics, manmade fibers, and agricultural chemicals. The decline in energy use per unit of output would probably have been steeper without this development.

The preembargo period also saw a drastic shift in the sources of energy used by industry, some

of which may well have contributed to the *decline in* energy use per unit of output. Between 1947 and 1972, the share of industrial energy use accounted for by coal—which burns relatively inefficiently—shrank from 55 to 20 percent. At the same time, shares of natural gas and petroleum expanded from 23 and 19 percent, respectively, to 45 and 25 percent. To some extent, the growth in natural gas and petroleum was attributable to rapid expansion of their use as feedstocks.

Meanwhile, use of electricity by industry grew rapidly, continuing the electrification of the sector that began early in the 20th century. Expansion of electricity use took place mainly from increased purchases of utility electricity, in part because the real price of electricity to industry fell. But self-generated electrical power also grew in absolute terms, though its relative share of the total amount of electricity used by industry fell. Purchases in 1972 were about five times the 1947 level; self-generated electricity was twice the 1947 volume.

Perhaps most notable about the drop in energy use per unit of output in industry between the late 1940's and early 1970's is that it occurred when the real price of energy was falling.

Trends Since 1972

The rate of decline in industrial energy use per unit of output has accelerated since 1972. **Sector** energy use for fuel and nonfuel uses per unit of output fell an average of 2.4 percent per year between 1972 and 1980, compared with the 1.1 percent decline of the earlier period. The causes of this more rapid decline appear to be a combination of: 1) a decrease in the energy-output ratio within each division, caused both by better housekeeping and by major capital equipment modifications, and 2) a product mix shift to less energy-intensive products. b

At the division level, manufacturing experienced an average annual decline of 3.4 percent per year in energy use per constant dollar of gross

product between 1972 and 1979 and, as the *largest* energy-using division, provided most of the impetus to lower energy use per unit of output in the industrial sector.

Energy use per unit of output in agriculture also fell, but less rapidly. Data for energy use and output in mining indicate a notable rise in energy use per unit of mining output. However, it is possible that difficulties encountered by estimators at the Department of Commerce in determining gross product originating in mining have resulted in an understatement in mining gross product and therefore an overstatement of energy use per unit of output in 1979.

Analysis of manufacturing energy use during the 1970's reveals considerable energy savings throughout the sector. In many cases, this energy efficiency improvement was assisted by faster output growth, especially in the less energy-intensive industries. Among industry groups, only one (tobacco manufacture) did not experience a decrease in energy use per unit of output between 1971 and 1979 (using Federal Reserve Board production indices to measure output change).⁷ Most industry groups achieved overall decreases of more than 30 percent in energy use per unit of output over the 8 years.

Smaller than average reductions in per-unit energy use by the largest and most energy-intensive industries during the 1970's are due to several factors. Slow economic growth and a major recession tended to hold down capacity utilization and, therefore, to boost energy use per unit of output. Slow growth in demand for an industry's products also reduced the rate of infusion of new state-of-the-art plants and equipment and minimized opportunities to incorporate the most energy-efficient, fixed capital, and production methods. Imposition of a variety of worker health and safety and pollution control regulations also had a negative impact on energy efficiency in the industries affected. a

^bSome analysts have attributed more of the acceleration in the decline in energy use per unit of output by the Industrial sector to the shift to less energy-intensive products than has been done here. See the DOE analysis described in fig. 10. Such a difference in results may be due to differences in the respective methods used and in the data available to and used by the analysts.

⁷OTA calculations based on production indices obtained from the Board of Governors of the Federal Reserve System and the energy use data from *The Annual Survey of Manufactures*, Bureau of the Census, Department of Commerce.

^aEdward F. Denison, "Effects of Selected Changes in the Institutional and Human Environment Upon Output Per Unit of Input," *Survey of Current Business* (Washington, DC.: U.S. Department of Commerce, Bureau of Economic Analysis, January 1978), pp. 21-44.

INDUSTRIAL ENERGY-RELATED TECHNOLOGIES AND PROCESSES

Certain energy-related, industrial technologies and processes, such as steam generation, transcend any particular industry. The generic technologies discussed in this chapter are technologies which, for the most part, exist today and are used by all four of the case study industries examined by OTA.

Although not a technology, perhaps the most important influence in conserving energy is the corporate energy manager, who is often used in conjunction with an energy review committee. Such an individual who can step back and examine the energy flows in an entire mill, or between mills in a corporation, can often achieve highly cost-efficient energy savings which others with more confined attention have not seen. The fact that this is not a hardware purchase, but rather a commitment of human talent should not disguise its importance as a means of energy conservation. Extensive documentation exists on the rewards attributable to making such a serious corporate commitment to energy conservation.⁹

Housekeeping

Housekeeping items are numerous. In the area of maintenance and repairs they include weatherstripping, replacement of wornout pipe insulation, improved maintenance of steam traps, and tuning of combustion equipment. Those measures for controlling energy waste range from manually switching off lights, machinery, and other energy-using equipment not in use, to designing and operating production schedules that ensure operation of equipment at maximum efficiency. An example of the latter would be ensuring that furnaces are operated only when their load is fully needed. A large amount of the energy savings by industry during the period 1974-80 were obtained by housekeeping.

⁹See, for example, NBS Handbook 115, *Energy Conservation Program Guide for Industry and Commerce*, Gatts, Massey, & Robertson (eds.) (Washington, D. C.: U.S. Government Printing Office, 1974).

Retrofitting

In the context of reducing energy use and increasing energy efficiencies, typical examples of retrofitting would be the installation of computer process and production control systems, combustion control systems on a burner array, an economizer on a boiler, or a variety of other heat exchange equipment designed to capture and use wasted heat.

Retrofits can be highly cost effective, not only because of the energy they save, but also because they often increase the performance level of their host equipment and thereby allow increased production without building new facilities. In this event, a retrofit can leverage much bigger costs elsewhere in the corporation and simultaneously offer the possibility of increasing output. Moreover, the small scope of many retrofit projects gives them an advantage: they are incremental purchases and hence have little associated risk. The cost of a retrofit is often low enough to be accommodated in the discretionary or contingency funds available to many mill managers.

Computer Control Systems

Two easily distinguished varieties of computer control systems—combustion control and process control—are examples of generic technology that can be bought specifically as an instrument to save energy, as with a combustion controller, or as part of an overall profit improvement program that saves energy in an incidental way, as with a process controller.

Combustion Control

In the combustion process, a given quantity of fuel requires a fixed and easily measured quantity of air. Having an excess (i.e., nonoptimal) quantity of air or fuel results in either unused air being heated or incomplete combustion of fuel. In either case, the full heat value of the fuel is not captured, and the overall conversion of fuel to electrical, mechanical, or thermal energy is not as efficient as it could be.

The aim of a combustion controller is to maintain the fuel-to-air ratio as close as possible to optimal by controlling the rate at which each is introduced to the combustion chamber. The controller performs its function by measuring the ratio of combustion products found in the exhaust gases. Products of combustion can include oxygen, carbon dioxide, and carbon monoxide. By monitoring ratios of these products, a computer can calculate an optimal air-fuel ratio, and make necessary corrections or adjustments to minimize inefficient combustion.

Modern combustion controllers are electronically based and, apart from being far more accurate than their old mechanical counterparts, are able to act more quickly to correct any imbalances. They are, therefore, far more efficient in their intended operation. Combustion control systems have been extensively applied to industrial operations and are expected to play an even greater role in the future.

Process Control

Process control is defined here as the computerized monitoring of process variables for the optimization of production. Process controls are almost universally applicable to industry; and although saving energy is not their primary function, it becomes a secondary benefit of the effort to increase overall efficiency and productivity.

Because of the increased speed of industry processes, hand-operated and slow-acting analog controls create inefficiencies. The advent of the microprocessor and of computer control systems has enabled industry to advance the speeds of processes, thereby maintaining higher efficiencies without losing control. Although not adopted universally, the use of process control technologies is expected to increase throughout industry over the next two decades.

Waste Heat Recovery

Wherever fuel is burned, the products of combustion are a potential source of wasted heat. Industrial processes employ a vast variety of fuel-burning equipment; therefore, the recovery of

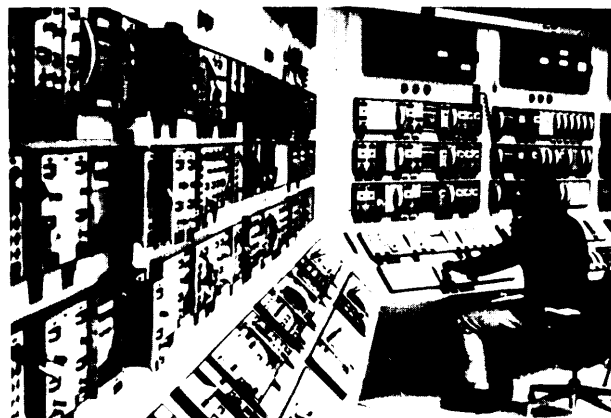

Photo credit: American Petroleum Institute

Control room at a modern petroleum refinery

waste heat has major potential for numerous energy conservation programs throughout the industrial sector. The task is to find suitable applications for the waste heat, much of which is at too low a temperature to be used as is.

Heat Exchangers

Heat exchangers are devices that transfer heat or energy from a high-temperature, waste heat source (e. g., the combustion gases) to a more useful medium (e. g., steam) for low-temperature use. The energy transferred can then be employed within the plant. Heat exchangers take many forms and include heat wheels, recuperators, economizers, waste heat boilers, regenerators, and heat pipes.

The cost of a heat exchanger of any type is often deceptively low. Installation costs are frequently triple (or more) the base price of the unit. Furthermore, maintenance costs can be significant, particularly if there are moving parts (as in a heat wheel), or where the flue gases are corrosive (as when burning high-sulfur oil or coal). In many industrial applications, heat exchangers are usually a more attractive investment when they are purchased as part of the original package of the furnace or boiler.

Upgrading Energy

Apart from these high-temperature, waste heat sources, industry has a variety of low-temperature

and low-level waste heat sources that can only be utilized by upgrading them—i.e., by raising their temperature and pressure. Two technologies for upgrading heat are:

- **Vapor recompression:** By vapor recompression, low-pressure steam is recompressed mechanically to a pressure and temperature that can be used in an industry.
- **Heat pump:** A heat pump converts waste heat into useful energy through a cycle of operations that can be described as a reverse refrigeration cycle.

In both cases energy must be added to upgrade the energy contained in the waste heat sources.

In terms of Btu, low-level waste heat sources would appear to have enormous potential. A substantial percentage of industrial energy input is rejected as low-level heat. However, the economics of recovering these Btu in the form of useful energy through such devices as vapor recompression and the heat pump vary greatly with the origin and quality of the waste heat source, the capital costs of the compressor or heat pump, and the energy cost associated with driving the system. Therefore, although these upgrading steps are technically the same across many industries, some pertinent applications and factors are industry-specific.

Electric Motors

The use of electricity by industry in 1980 was 2.8 Quads (or three times greater if one includes the electricity generated by utilities burning fossil fuels). Of that, roughly 80 percent was for mechanical drive, which essentially means electric motors. Accordingly, there is a large energy-saving opportunity associated with increasing the efficiency of electric motors. Standard electric motors range in efficiency from between 80 to 90 percent. By increasing the iron and copper content of the core and windings, respectively, energy efficiencies can be improved to beyond 95 percent.

This incremental increase in efficiency may not appear significant at first sight. However, electric motors are almost unique among capital in-

vestments in that their capital costs are only a small fraction of their operating costs, even with the added iron and copper content of the higher efficiency motors. For example, an electric motor could use in excess of 10 times its capital cost in energy each year, and the difference between a 90- and 95-percent efficiency could mean an annual energy saving of between 50 and 60 percent of a motor's capital costs. However, the electric motor is a very reliable item of equipment. In normal atmospheric applications it can have a life expectancy in excess of 20 years. Because of this, the replacement of a low-efficient electric motor with its high-efficient counterpart often comes under discretionary spending. Although the replacement of a functioning motor could be economically justified, it would certainly not be mandatory. On the other hand, when an electric motor has reached the end of its useful life, it is common to replace it by a newer, more efficient type.

Fuel Switching

In U.S. manufacturing, there exists an economic incentive to use one fuel over another when prices differ. In addition, noneconomic factors would also lead a firm to use one fuel over another. Such noneconomic factors are usually related to security of supply or to government regulation.

OTA analysis indicates that there are two trends in fuel switching that will continue for the next two decades. The first trend is toward the use of coal as a primary boiler fuel at industrial plant sites. The second is toward the increasing use of cogeneration facilities in which both electricity (or *perhaps* mechanical and drive power) and steam are produced simultaneously.

Technology for Converting to Coal

Although switching from natural gas or oil to coal does not usually constitute an improvement in energy efficiency, it may very well be a desirable goal from a national point of view. Coal prices are often one-quarter of the cost of oil in terms of Btu purchased.

Some of the well-documented¹⁰ barriers preventing a smooth and consistent transition from natural gas or oil to coal, however, include the following:

1. Within the corporate plant, switching from natural gas or oil to coal would be of very low priority in the discretionary spending pool unless it could be readily coupled to security of supply.
2. Unless the boilers were originally designed for coal, a complete new boiler plant would be required, including all the coal storage and handling equipment, as well as equipment for ash removal. If existing boilers were still operational, their premature replacement would very rarely make economic sense.
3. The installation of material-handling equipment, as described in (2), above, requires large amounts of space, as does the storage of coal. Such space is often at a premium at most industrial sites.
4. Pollution control technology for coal is extremely expensive and far more complex than that necessary for gas or oil. In fact, natural gas requires no special technology, and, providing that one can purchase low-sulfur oil, all other regulations can easily be met. Even if low-sulfur coal can be obtained, it requires equipment to remove fly ash and particulate. Furthermore, there is now a perceived risk involved in burning coal because of the attention and publicity associated with acid rain.
5. In the large installations, deliveries of coal can involve major capital and space allocations for railroad facilities and sidings. On the other hand, oil and gas for this type of facility can be fed into the plant via pipeline.

Thus, despite the large cost advantage of coal, most of the problems listed above tend to undermine the attractiveness of coal. Some of the newer coal-burning technologies (i.e., fluidized bed combustion or the burning of coal/water mixtures) may reduce these problems. However, until these technologies have actually been proven,

¹⁰ *The Direct Use of Coal: Prospects and Problems of Production and Combustion* (Washington, D. C.: U.S. Congress, Office of Technology Assessment, OTA-E-86, April 1979).

there is no way to assess their impacts, and, under the present economic and competitive environment, it will take a long time for coal to make major inroads as an energy source in most industries.

Cogeneration

Cogeneration is defined as the production of both electrical or mechanical power and thermal energy from a single energy source.¹¹ In industrial cogeneration systems, fuel is first burned to produce steam. This steam is then used to produce mechanical energy at the turbine shaft, where it can be used directly, but more often is used to turn the shaft of a generator, thereby producing electricity. Although the steam that leaves the turbine is at a lower temperature and pressure than that which entered, it still has sufficient thermal energy to perform the heating and mechanical drive duties required throughout the plant. In contrast to cogeneration systems, conventional industrial power systems produce their own thermal energy at the plant site but usually buy their electrical power from a utility.

The principal technical advantage of a cogeneration system is its ability to improve the efficiency of fuel use. In producing both electric and thermal energy, a cogeneration facility uses more fuel than is required to produce either electrical or thermal energy alone. However, the total fuel required to produce both types of energy in a cogeneration system is less than the total fuel required to produce the same amount of power and heat in separate systems. Because it produces two energy forms, a cogenerator will have less electrical output from a given amount of fuel than will a comparable powerplant. However, when steam and electrical efficiencies are summed, the cogenerator will achieve overall fuel use efficiencies 10 to 30 percent higher than the sum of separate conventional energy conversion systems.

Cogeneration does not easily fit into any of the previously described categories such as retrofitting or housekeeping, and although presented in this section, is not entirely a generic technology.

¹¹ A more detailed discussion of promising cogeneration technologies and their potential impacts can be found in: *Industrial and Commercial Cogeneration* (Washington, D. C.: U.S. Congress, Office of Technology Assessment, OTA-E-1 92, February 1983).

Cogeneration is really a new name for an old and proven practice. Around the turn of the century, industry produced more than 50 percent of the electricity generated in the United States. By 1950, only 15 percent of the U.S. electricity was produced by cogeneration systems in large on-site industrial plants; by 1970, this figure had dropped to less than 5 percent.

Historically, in order to justify a cogeneration system economically and technically, a plant either had to have a balanced need for thermal and electrical or shaft power that was congruent in both time and amount (e.g., the peak requirement for electricity and steam had to be coincident, and their load profiles similar). If such balance and congruence were not present, the system had to be able to distribute excess electricity to other sites or to purchase backup electricity from the local utility. However, few industrial processes had power needs that were this balanced. Moreover, systems that sold electric power were subject to regulation as utilities, and backup power often was more expensive than was regular electrical service. Thus, throughout this century, as electricity from utilities became progressively cheaper, industry found other uses for its capital, and the use of cogeneration by industry declined.

Now, however, the picture has changed, both from an economic and legislative standpoint. In economic terms, the cost of a new, large, utility generating plant increased in recent years to well over \$1,000/kW. Furthermore, utilities have been affected by the massive increases in energy prices. The combined effects of increased capital and operating costs have increased the attractiveness of cogenerating facilities once again. In addition, Congress has passed the Public Utility Regulatory Policies Act (PURPA, Public Law 95-617), which mandates that utilities purchase the excess electrical energy generated by a cogeneration facility and provide backup service at a reasonable rate. This situation alleviates the necessity of a rigorous energy balance within the plant and allows the cogenerator to retrieve some of its capital expenditure through the sale of electricity to a utility or the purchase of electricity from a utility.

The economic key to cogeneration is the utilization of the waste heat from the cogeneration process, a potential not usually available to a utility. A high level of efficiency for a utility operation would be on the order of 35 to 37 percent, whereas an industrial cogeneration operation may reach an overall efficiency in excess of 70 percent.

Although most of the regulatory problems associated with the sales of industrially cogenerated electric power have been removed by PURPA, industry is unlikely to rush to make the significant new investments required for such operation. Examples of the disincentives facing industry are the following:

1. The environmental implications of cogeneration can be a problem to industry, although they are sometimes overlooked in discussions of the benefits from cogeneration. There is no automatic way for a potential industrial cogenerator to get regulatory approval for the emissions its additional use of fuel will generate. Even though incremental electrical energy will be made available at perhaps half the emission rates of the utility's powerplant, the industrial emitter gets no credit for this improvement. Instead, the emissions would be charged directly and entirely to the industry.
2. How the financial returns from cogenerated electrical energy can be predicted is still uncertain. There has been considerable publicity about the "high" prices (from 5¢ to perhaps even 10¢/kWh) that a utility will have to pay cogenerators and other producers of electricity for the energy that the utility has been able to "avoid" generating or purchasing from the grid. But the situation is not this simple. In many areas (e. g., where utilities have excess capacity or low-cost generating plants), the rates for purchases of power from cogenerators maybe as low as 1¢/kWh.
3. Achieving cogeneration efficiencies at the cost of reducing utility coal use and increasing industrial use of petroleum-derived fuels, would probably not be desirable if the primary goal of national energy policy were net oil savings.

4. Finally, and this may in many instances be the ultimate consideration, even a very attractive cogeneration project may not meet industry management's exacting requirements for the short paybacks and high rates of return that are used to evaluate all projects seeking a share of the hard-pressed, companywide capital budget.

Product Mix Shift

As energy costs increase or uncertainties prevail over future fuel costs and supply, industries will almost automatically, and on an evolutionary basis, move to minimize these costs, risks, and uncertainties. One method of achieving this is to manufacture existing product lines with less process energy through the introduction of more efficient technology.

However, three other alternatives are also available. First, a company could cease manufacturing products that are energy-intensive and put capital to work instead in other spheres of business and industry. For example, Japan, which is having great difficulty in competing with U.S. manufacturers of aluminum and paper, may take measures to secede from these businesses entirely.

Second, a company could develop and manufacture new products that use less energy, yet compete with the old energy-intensive product. An obvious example is the small automobile in

competition with the large automobile. Even within this broad category are competing considerations. For example, in the car itself, aluminum and plastics readily replace other metals, such as steel. Arguments that the energy intensity associated with making one product is more desirable than that used for making another product are not really conclusive. Examples include debates about which packages are less energy-intensive—i.e., the glass bottle v. the plastic bottle or the aluminum can v. the steel can. In the final analysis, the marketplace, which considers many other costs besides energy, determines which product wins or loses.

The third course of action occurs when the energy used to make a final product is shifted away from the manufacturing facility to the user of the product. An example of this can be found in the petroleum refining industry. Although less refined gasolines require less energy to produce, they burn less efficiently in automobiles, thereby lasting fewer miles per gallon and increasing the energy cost of transportation. The refinery has essentially shifted part of its energy losses to consumers using these products.

The measurement and quantification of the impact on energy conservation by product shift and product change is beyond the scope of this report. However, it should be noted that over time, these changes almost will inevitably take place to an extent that products and even whole industries could radically contract and disappear.

POLICIES THAT AFFECT INDUSTRIAL ENERGY USE

Existing U.S. Industry Energy-Related Legislation

During the 1970's and early 1980's, Congress enacted several major laws that affected industrial use of energy. The general goals of these measures were to reduce oil imports, to encourage domestic production of fossil fuels and the development of nuclear and alternative energy sources, and to reduce energy demand through conservation and energy efficiency improvements. Incentives to meet these goals fell into three general categories: 1) pricing mechanisms, 2) regulations,

and 3) financial incentives. In addition, DOE conducts several programs designed to study industrial energy use and ways to improve energy efficiency in industry.

Pricing Mechanisms

Oil and natural gas pricing issues dominated congressional energy debate in the 1970's. The difference between domestic oil prices and higher world energy prices was significant and had to be resolved. After a year-long debate, the Energy Policy and Conservation Act (EPCA, Public Law

94-1 63) was enacted in December 1975. The law provided for the eventual decontrol of oil after September 30, 1981; however, mandatory Federal oil price controls were continued until June 1, 1979, EPCA gave the President authority to continue, modify, or remove the controls after that date. In April 1979, President Carter submitted to Congress his plan, later approved by Congress, to phase in oil decontrol to cushion consumers from rising prices. Oil decontrol proponents believed higher prices would encourage domestic oil production and discourage use while advocates of price control were concerned that higher domestic oil prices would contribute to inflation and burden consumers without providing commensurate new supplies.¹²

To accompany oil decontrol, the Crude Oil Windfall Profits Tax Act (WPTA, Public Law 96-223) was passed in April 1980. Designed to capture some of the windfall profits that oil companies would realize from decontrol, this new tax was levied only on the difference between the base price (ranging from \$12.81 to \$16.55) and the actual selling price of a barrel of oil. The tax rate varied from 30 to 70, depending on the type of oil, the date the well was tapped, the method of production, and the size of the producer.¹³ To date, total revenues collected from the windfall profits tax amount to \$28.1 billion (\$3.7 billion in fiscal year 1980, \$13.8 billion in fiscal year 1981, \$10.6 billion in fiscal year 1982). These revenues have been added to general U.S. Treasury funds and not to specific energy-related or transportation projects. On January 28, 1981, President Reagan lifted price and allocation controls on gasoline and crude oil.

For natural gas, the Natural Gas Policy Act (NGPA, Public Law 95-621) provided for continued controls indefinitely on most natural gas contracted for prior to 1977, thus avoiding a sudden windfall for producers. The act further specified that price controls on new gas and certain intrastate gas be lifted entirely by 1985 and that gas from certain onshore wells be deregulated in July 1987. NGPA also provided for incremen-

tal pricing, thus placing the initial burden of gas price deregulation on industrial customers. The incremental price is equal to the price of newly discovered natural gas plus regulated transportation costs. This industrial gas price is mitigated through a ceiling determined by regional alternative fuel oil prices for either number 2 or number 6 fuel oil.

The Federal Energy Regulatory Commission (FERC), which administers NGPA, is now considering raising old natural gas* prices. FERC plans to issue a Notice of Inquiry that will explore whether NGPA fosters market ordering problems, such as unequal distribution of gas among interstate and intrastate pipelines, and whether such problems can be alleviated by raising the price of old gas. The FERC staff has suggested that higher prices would eliminate the cushion of price-controlled gas now enjoyed by interstate pipelines. The record developed during the Notice of inquiry could be used as a basis for future FERC rulings.¹⁴

On February 23, 1983, the administration submitted to Congress a proposal to eliminate all natural gas price controls and enable pipelines and producers to abrogate long-term contracts that are believed to be keeping prices high. In addition to the administration proposal, several alternative proposals have been introduced. Legislative debate has focused on the decontrol of old gas. Decontrol, opponents argue, means higher rates for homeowners who cannot easily switch to other fuels. Also, there is concern that rising gas prices could prompt industrial and utility users to switch to oil. Because gas prices, in some areas, have surpassed industrial fuel oil, switching has already begun to occur. However, proponents argue that eliminating all controls would encourage the production of old gas and cause old gas prices to increase and new gas prices to decrease.¹⁵

*Old gas is that which was discovered before 1977, and whose price is federally controlled.

¹⁴*Inside Energy* (New York: McGraw Hill, April 1982), pp. 7-8.

¹⁵Congressional Quarterly Weekly Report, "Natural Gas Prices: Ready for the Free Market?" vol. 41, No. 9, Mar. 5, 1983, pp. 443-447.

¹²*Energy Policy*, 2ded. (Washington, D. C.: Congressional Quarterly, Inc., March 1981), p. 25.

¹³ *ibid.*, p. 224.

Regulations

The Government can also intervene in the energy marketplace through regulation. In the industrial sector, Government policies seek to promote the switch from oil and natural gas to coal or renewable resources. Since 1974, the Federal Government has administered coal conversion programs under provisions of the following legislation: EPCA, the Environmental Supply and Environmental Coordination Act (ESECA, public Law 93-319), and the Powerplant and Industrial Fuel Use Act of 1978 (FUA, Public Law 95-620).

ESECA prohibited any powerplant or major fuel-burning installation from burning natural gas or petroleum as a primary fuel source if the plant or installation had the capability and necessary equipment to burn coal. EPCA expanded the authority of the Federal Energy Administration to order major powerplants and fuel-burning installations to use coal instead of oil and gas. FUA further modified and expanded coal switching programs and established new regulatory policies for converting industrial users of oil and natural gas to coal. Under FUA, new facilities may not burn oil or gas until the owners demonstrate to DOE that an exemption is justified. Also, FUA prohibited the burning of natural gas in existing powerplants from 1990 on and restricted its use prior to then. However, a full range of temporary and permanent exemptions was established.¹⁶

The omnibus Budget Reconciliation Act of 1981 (Public Law 97-35) made changes in FUA. It repealed the general prohibition against burning gas in existing powerplants and withdrew the authority of DOE to prohibit burning oil/natural gas in existing powerplants if the plant were capable of using coal or alternative fuels. Instead, the law allows a utility to certify to DOE whether a powerplant is capable of burning coal/oil or coal/gas and gives DOE authority to prohibit the burning of oil/gas in such plants as certified.

The effectiveness of coal conversion programs is questionable for a number of reasons. The cost of fuel conversion is staggering, and it may be impractical to retrofit some plants. Capital con-

straints will stretch the time for completion even further. And, while coal is cheaper than oil on a Btu basis, it is not necessarily a cheap fuel when transportation, handling, and pollution control costs are included. In addition, coal-fired boilers are more expensive to purchase than are oil-fired boilers. This reality could be a deterrent to greater coal use, particularly in smaller companies that do not have access to the capital necessary to buy new boilers or to retrofit old ones. In addition, exemption provisions of the law still allow companies to continue burning oil and gas. A company can petition for an exemption for a variety of reasons: air quality, site limitations, and cost.

Another law that can affect energy use in the industrial sector is PURPA. PURPA is intended to encourage the production of power by means of cogeneration and the use of renewable resources, primarily by removing the principal barrier to electric power generation—market entry. Prior to PURPA, utilities were often reluctant to purchase cogenerated electricity at a rate that made grid-connected cogeneration economically feasible. Some utilities charged very high rates for providing backup service to cogenerators (for that electricity that cogenerators could not provide for themselves). With PURPA, utilities must purchase from and sell power to cogenerators and small power producers at economically justified and equitable rates. However, not all cogenerating facilities qualify for the PURPA benefits. A qualifying cogenerating facility* must meet FERC requirements for fuel efficiency, reliability, and the like. Presently, the potential size and structure of the market for cogeneration and small power production is largely unknown.

The U.S. Supreme Court recently upheld the FERC regulations implementing PURPA that require: 1) utility rates for purchases of cogenerated power to be based on the utility's "full avoided cost," ** and 2) utilities to interconnect with cogenerators and small power producers. A Federal Court of Appeals decision had found

● A cogenerating facility, as defined by the law is one that produces both electric energy and steam, or other forms of useful energy (such as heat), which are used for industry, commercial heating, and cooling.

* ● The cost of power generated by conventional means that is avoided or replaced by power from alternative energy technologies.

¹⁶Congressional Research Service, *The 95th Congress and Energy Policy*, prepared for the House Subcommittee on Energy and Power, January 1979, p. 13.

that full avoided cost pricing deprives other utility ratepayers of any share of the benefits and that the FERC interconnection requirement violated other provisions of the Federal Power Act.¹⁷ The Supreme Court ruled that, while full avoided cost pricing would not directly provide any rate savings to consumers, it would provide a significant incentive for the development of cogeneration and small power production, and ratepayers and the Nation as a whole would benefit from the decreased reliance on scarce fossil fuels through the more efficient use of energy. The Supreme Court also held that FERC's authority under PURPA is adequate to promulgate rules requiring utilities to interconnect with cogenerators and small power producers.

In an earlier decision, the U.S. Supreme Court upheld the constitutionality of the PURPA requirement that utilities buy power from cogenerators and small power producers and upheld the provision that exempts these facilities from regulation as electric utilities.¹⁸ These aspects of PURPA had been declared unconstitutional by a Federal district court on the grounds that they exceeded the scope of the power granted to the Federal Government under the U.S. Constitution.¹⁹

Financial Incentives

Financial incentives, such as tax credits and accelerated depreciation measures, can be directed toward encouraging the use of coal or alternative energy sources and the adoption of conservation projects. Since the Arab oil embargo, the political climate has generally been favorable to the use of financial incentives. Opposition to these measures was not directed at the concept, but at the amount or timing of the incentive. Some critics argued that the tax credits proposed were not strong enough to affect energy conservation efforts or to compensate for the increased capital outlay and technological risks associated with

greater coal usage. Others argued that tax credits involve the Government in the industrial decisionmaking process too heavily. What finally emerged from this congressional debate were several laws that provided a number of financial incentives to industry: the Energy Tax Act of 1978 (ETA, Public Law 95-618), WPTA, and ERTA.

ETA provided a 10-percent business investment credit for: 1) specified equipment, such as boilers that use coal or alternative fuels; 2) heat conservation; and 3) recycling and shale oil equipment. This credit could be applied to equipment placed in service between October 1, 1978 and January 1, 1983. At the same time, the law denied a tax credit and granted a rapid depreciation allowance for early retirement of oil- and gas-fired boilers. ETA also encouraged the production of additional fuel supplies, particularly natural gas, by providing a tax credit for equipment used for the production of natural gas from geopressurized brine.

WPTA increased the tax credits for solar, wind, and geothermal equipment from 10 to 15 percent and extended to 1985 the cutoff for granting credits. Also, the law provided a tax credit equal to 10 percent of the cost of cogeneration equipment and extended the tax exemption for industrial development bonds to bonds used to finance facilities that produce energy from renewable resources, as long as the facility was State-owned, backed by sufficient taxing authority, and eligible for financing by general obligation bonds,

One of the most important tax initiatives for industry is ERTA. This law simplified the tax code for depreciation, replacing all capital retirement categories with just four: 3 years for vehicles; 5 years for most machinery and equipment and single-purpose agricultural structures, petroleum storage facilities, and public utility property with a life expectancy of 18 years or less; 10 years for recreational facilities and park structures, mobile homes, and qualified coal conversion property and other public utility property with a life expectancy of 18.5 to 25 years; and 15 years for depreciable real property and public utility property with a life expectancy of 25 years or more. Also, the law encouraged investment in both new and used property placed in service after 1980 by establishing new credit rules: 6-percent credit

¹⁷*American Electric Power Service Corporation v. FERC* (675 F.2d 1226 (D.C. Cir. 1982), cert. granted in Case Nos. 82-34 and 82-226 (Oct. 12, 1982).

¹⁸*Federal Energy Regulatory Commission v. Mississippi*, _____ U.S. _____, 102 S. Ct. 2126 (1982).

¹⁹*Mississippi v. Federal Energy Regulatory Commission* (unreported opinion, U.S. District Court for the Southern District of Mississippi).

applies to qualified property in the 3-year depreciation class and 10 percent applies for all other qualified property. The investment credit carry-over period is extended to 15 years for credits arising in taxable years ending after 1973. In addition, ERTA provided a 25-percent tax credit for research and development (R&D) expenditures paid or incurred in carrying on a trade or business, rather than in connection with a trade or business. Eligible expenditures include supplies used in conducting research and wages to employees performing the research. Furthermore, ERTA reduced the tax on newly discovered oil, and decreased the credit allowed where the cost of energy savings is excessive or where capacity increases as energy is conserved.

Since ERTA shortened the period in which businesses could write off investments, companies could deduct larger amounts each year from their corporate income taxes, thus lowering tax bills and presumably encouraging investment. Critics, however, point out that accelerated depreciation would favor large businesses and would affect individual industries very differently. Furthermore, accelerated depreciation would substantially increase certain types of distortions that exist in present law—particularly those that favor equipment over structures. They also point out that accelerated depreciation will cost the U.S. Treasury billions of dollars in lost revenues. Proponents, on the other hand, say the act simplifies tax laws and will stimulate the economy, increase productivity, and moderate inflation.²⁰

ERTA also liberalized earlier leasing rules to promote the sale of tax benefits—both investment credits and depreciation deductions.

Under these new leasing regulations, a corporation who (because of small or nonexistent tax liabilities) is unable to make use of a property's depreciation and tax credits can sell the property and its associated income tax credits to another corporation, and then immediately lease the property back for continued use. The original owner, now a lessee, receives a downpayment and a note for the balance. The new owner, now

a lessor, receives payments for rent and makes payments for principal and interest on the outstanding note. Since the property never leaves its original site, and the rental and debt payments are equal, the net effect is that the original owner of the equipment has sold its unusable tax and depreciation credits for the dollar amount received as a downpayment.²¹

In an alternative third-party safe harbor lease arrangement, the lessee is not the actual owner of the property. The new owner purchases the property from the actual owner and then leases it to the lessee at an annual rent that is lower by the tax benefit amount associated with the property,²²

The U.S. Treasury reported that the value of leased property in 1981 totaled \$19.3 billion. About 84.5 percent of the tax benefits from leased property went to the lessee, while 14.2 percent was retained by the lessor. The remaining 1.3 percent covered transaction costs to third parties.²³

The Tax Equity and Fiscal Responsibility Act of 1982 (TEFRA, Public Law 97-248) modified the safe-harbor leasing provisions of ERTA with respect to eligibility requirements, eligible property, ACRS deductions, investment credits, and lessee/lessor limitations.

Under prior law, the term of a safe-harbor lease could not exceed the greater of 90 percent of the useful life of the property or 150 percent of the average depreciation range (ADR) midpoint life of the property. Under the new law, the lease term cannot exceed the greater of the recovery period of the property or 120 percent of the ADR midpoint life. A second change brought about in TEFRA is that public utility property is no longer eligible for safe-harbor leasing. A third change is that only 20 percent of an investment tax credit (ITC) for property in a safe-harbor lease is allowable in the first taxable year and 20 percent in each of the four succeeding taxable years. Previously, 100 percent of an ITC was allowable when the property was placed in service. Fourth, a lessor is not allowed deductions or credits from

²⁰Congressional Research Service, "The Capital Cost Recovery Act: An Economic Analysis of 10-5-3 Depreciation," Jan. 28, 1980, p. 2.

²¹U.S. Department of Treasury, Office of Tax Analysis, *Preliminary Report on Safe Harbor Leasing Activity in 1981*, Mar. 26, 1982, p. 2.

²²*Ibid.*, p. 1.

²³*Ibid.*

safe-harbor leases to the extent those deductions or credits reduce its income tax liability by more than 50 percent. Finally, the law repeals safe-harbor lease provisions for leases entered into after December 31, 1983.

The Industrial Energy Conservation Program

The DOE Industrial Energy Conservation Program focuses on improving the energy efficiency of the most energy-intensive processes used in the U.S. industrial sector and on utilizing waste heat from these processes. The DOE Office of Industrial Programs administers this program, which is divided into four subprograms.

1. The **Waste Energy Reduction Program** focuses on improving energy efficiency and on substituting abundant for scarce fuels in processes that are common to many industries. Activities within this program include R&D for waste heat recovery and for combustion efficiency improvements.
2. The **Industrial Process Efficiency Program** focuses on increasing energy efficiency in the most energy-intensive industries. The areas of activity include cost-shared research, development, and demonstration (RD&D) efforts in steel, paper, aluminum, and textiles. Specific projects include a dewatering process development for pulp and paper, the identification of energy conservation potential in the chemicals and petroleum industries, and the continuous casting and hot inspection of steel ingots.
3. The **Industrial Cogeneration Program** focuses on improving and implementing advanced cogeneration systems that offer large energy savings, while minimizing oil and gas consumption.
4. The **Implementation and Commercialization Program** focuses on stimulating new as well as existing, but underutilized, energy conservation technologies in the industrial sector. An important activity of this program is the industrial energy efficiency reporting program established by EPCA. That act directed DOE (then the Energy Research and Development Administration) to rank the top 10 energy-consuming industries and establish voluntary efficiency-improvement targets for each and a system for reporting annual progress. The National Energy Conservation Policy Act of 1978 (NECPA, public Law 95-61 9) expanded the reporting requirements of the program to include all industries using 1 trillion Btu per year. This program was one of the Government's earliest efforts in industrial energy conservation and helped achieve a higher visibility for conservation.

The future of the Industrial Energy Conservation Program is questionable. The Reagan administration has recommended that Federal industrial energy conservation programs be curtailed. Also, several bills were introduced in the 97th Congress to dismantle or eliminate DOE. If that were to occur, it is not known whether the Industrial Energy Conservation Improvement Program will be shifted to another agency.

FOREIGN INDUSTRIAL ENERGY USE AND POLICY

A useful context in which to view U.S. industrial energy use is within comparable energy use by industries in other developed nations. * If interpreted carefully, such comparisons can indicate the potential for U.S. energy productivity im-

provements in the future and help identify policies that can facilitate such improvement.

Total industrial energy and oil use by seven international Energy Agency (IEA) countries in 1973 and 1979 are shown in table 10. * Based on ratios of energy use to per capita income, GNP, or gross

*Industrial energy use data are readily available only for IEA countries and not for other industrial nations such as those in South America. Hence, this discussion of comparative energy use will focus on IEA countries.

*IEA was established in November 1974 within the framework of the Organization for Economic Cooperation and Development (OECD) to implement an international energy program.

Table 10.—Industrial Energy and Oil Use by Representative IEA Countries, 1973 and 1979 (millions of barrels of oil equivalent)

| Country | 1973 | | 1979 | |
|--------------------------|-----------|---------|-----------|---------|
| | Total use | Oil use | Total use | Oil use |
| Australia | 135.3 | 50.6 | 177.2 | 52.8 |
| Canada | 352.9 | 162.0 | 458.8 | 156.9 |
| West Germany | 676.8 | 344.5 | 654.2 | 274.1 |
| Italy | 386.5 | 234.6 | 344.2 | 164.2 |
| Japan | 1,084.7 | 644.3 | 1,130.9 | 687.6 |
| Sweden | 122.8 | 67.4 | 105.5 | 46.2 |
| United Kingdom | 510.7 | 272.7 | 473.1 | 221.4 |
| United States | 3,452.2 | 939.0 | 3,257.8 | 1,172.8 |
| IEA total | 7,503.6 | 3,136.5 | 7,465.2 | 3,195.1 |

SOURCE: Energy Conservation: The Role of Demand Management in the 1980's, International Energy Agency, 1981.

domestic product (GDP), the United States is a highly energy-intensive nation and has been for many years.* In fact, among the developed Western nations and Japan, only Canada is more energy-intensive than the United States.

This fact has prompted speculation that the United States could shift to significantly reduced levels of energy use without adverse impact on economic activity. However, studies carried out at Resources for the Future (RFF)²⁴ point out that intercountry comparisons are complex and that "energy/GDP ratios taken by themselves are at best only a partial indicator of energy conservation potential among countries or of progress in energy conservation over time."²⁵ Specifically, RFF points out that careful attention must be paid to differences in composition of economic output, the structure of fuel supply, the vintage of energy-using equipment, energy prices, differences in geography and tastes, and the relative energy intensiveness of a wide range of activities. The RFF study concluded that approximately 40 percent of the difference between the higher U.S. energy/GDP ratio and the lower foreign ratios

could be attributed to such U.S. structural characteristics as the large size of the United States and its dispersed population patterns. About 60 percent of the difference arises from energy intensity differences in specific applications. For example, energy use per unit of output in a number of manufacturing activities is higher in the United States than in Europe (see table 11). Evidence is accumulating that, in substantial part, such differences are due to the historically higher energy costs seen by foreign industry. European energy prices have generally been held above market levels through taxation, while in the United States they were held down through the use of controls from 1971 through early 1981.

Under sharp increases in average real energy prices paid by industrial users since 1973, overall industrial energy use in the 21 IEA countries evolved as shown in table 12. While industrial

Table 11.—Comparative Energy Efficiencies of Industrial Processes in Representative IEA Countries^a

| Country | Crude steel | Pulp and paper | Petroleum products |
|-------------------|-------------|----------------|--------------------|
| Canada | 102 | 116 | 200 |
| Italy | 62 | 59 | 50 |
| Japan | 94 | 88 | 51 |
| Sweden | 73 | 84 | 54 |
| United Kingdom | 88 | 108 | 81 |
| United States . . | 100 (543) | 100 (579) | 100 (90) |
| West Germany . | 60 | 76 | 89 |

^aRelative 1975 consumption in Btu per ton of product; U.S. consumption defined as 100 in all cases. Actual U.S. consumption is 104 Kcal/ton of product shown in parentheses.

SOURCE: "Energy Topics: A Periodic Supplement to IGT Highlights" (table 7), Institute of Gas Technology, Apr. 11, 1977

*For most countries the difference between gross domestic product (GDP) and gross national product (GNP) is relatively minor. Energy-to-GDP ratio is most often used for energy comparisons because GDP reflects only a nation's domestic economic activity, excluding income derived from overseas enterprises and investments, and is therefore the more appropriate national accounts measure to which to relate a nation's domestic energy consumption. The U.S. GDP is virtually identical to U.S. GNP. For some nations the GDP may be as much as 5 percent below the GNP.

²⁴Joel Darmstadter, Joy Dunkerly, and Jack Alterman, "HOW Industrial Societies Use Energy: A Comparative Analysis" (Baltimore, Md.: The Johns Hopkins University Press, 1977).

²⁵Joy Dunkerly, "Energy Use Trends in Industrial Countries: Implications for Conservation," *Energy Policy*, June 1980.

Table 12.—Changes in Industrial Energy Consumption in IEA Countries Between 1973 and 1978

| Energy carrier | Iron and steel | Chemicals | Petrochemicals | Other | Nonenergy uses | Total industry |
|-------------------------------------|----------------|-----------|----------------|--------|----------------|----------------|
| Absolute change:^a | | | | | | |
| Oil | -95.3 | +51.3 | + 102.6 | -58.6 | +29.3 | + 36.7 |
| Gas | -44.0 | +22.0 | — ^b | -205.2 | — | -227.2 |
| Electricity | +7.3 | -22.0 | +51.3 | +36.7 | — | + 73.3 |
| Solid fuels | - 175.9 | +7.3 | — | -73.3 | — | -249.2 |
| Total | -307.9 | +58.6 | + 153.9 | -300.4 | +29.3 | -366.5 |
| Percent change: | | | | | | |
| Oil | -36.2 | +28.2 | + 14.2 | -4.9 | +4.6 | +1.2 |
| Gas | -20.3 | +11.2 | — | + 14.3 | — | - 12.6 |
| Electricity | +4.1 | -9.5 | +854.9 | +5.2 | — | +7.0 |
| Solid fuels | -18.8 | +19.9 | — | -14.1 | — | +17.0 |
| Total | -19.5 | +10.0 | +21.0 | -7.9 | +4.4 | -4.9 |

^a in millions of barrels of oil equivalent.

^b — indicates negligible change.

SOURCE: Energy Conservation: The Role of Demand Management in the 1980's, International Energy Agency, 1981.

production increased by 8.3 percent between 1973 and 1978, total energy use decreased by 4.9 percent. Oil use rose slightly (1.9 percent), mainly as a result of increases in oil use in the petrochemical and chemical industries.

Looking ahead, primary fuel use is expected to increase 36 percent between 1985 and 1990, while oil use is expected to rise only 4 percent, according to IEA projections (see table 13). However, fuel use in individual countries varies considerably. For example, while industrial oil use is expected to decrease in the United States and in four other IEA countries, it is expected to stay level or increase in 16 others.

National Programs To Spur Industrial Energy Conservation

IEA countries generally identify energy prices and taxes as the most important targets of industrial energy conservation programs because of industry's sensitivity to increased costs. Thus, almost all IEA countries have introduced a range of other measures to complement the effects of increased energy prices. These measures vary from country to country, reflecting different social philosophies and economic conditions. Some countries place primary emphasis on voluntary and incentive measures, while others rely on mandatory programs. As summarized by IEA,

Table 13.—Projected Trends of Industrial Energy and Oil Use in Selected IEA Countries Through 1990^a (millions of barrels of oil equivalent)

| Country | 1985 | | 1990 | |
|--------------------------------------|-----------|---------|-----------|---------|
| | Total use | Oil use | Total use | Oil use |
| Australia | 230.6 | 53.6 | 268.3 | 54.2 |
| Canada | 557.4 | 146.6 | 640.9 | 137.8 |
| West Germany | 704.6 | 274.1 | 741.0 | 271.2 |
| Italy | 404.3 | 160.5 | 441.1 | 140.7 |
| Japan | 1,500.6 | 796.8 | 1,882.6 | 841.5 |
| Sweden | 140.8 | 63.8 | 151.0 | 54.2 |
| United Kingdom | 531.6 | 245.6 | 564.6 | 245.6 |
| United States | 3,553.2 | 1,048.2 | 3,940.0 | 945.6 |
| Total for all 27 IEA countries | 8,801.8 | 3,327.1 | 10,088.1 | 3,319.0 |

^a Includes nonenergy uses.

SOURCE: Energy Conservation: The Role of Demand Management in the 1980's, International Energy Agency, 1981

the most important measures that have been adopted so far in IEA countries are:

- **fiscal and financial incentives**, to encourage investment in energy saving techniques and, in particular, to speed up the marketing of new energy-saving equipment. Projects with a longer pay-back period or a high risk are generally given priority assistance. Notable programs of this kind are the financial and fiscal incentives which are given in Denmark, the Netherlands, and Sweden in order to promote energy-saving investment in industry;
- **reporting and auditing schemes**, often in combination with mandatory or voluntary target setting. Information from reporting and auditing schemes is also used to advise the various sectors of industry and to help governments formulate an energy-related strategy. For instance, mandatory reporting of energy consumption figures or compulsory energy audits are used in the United States and Spain. Voluntary systems exist, for example, in the United Kingdom's industrial Energy Thrift and Audit Scheme;
- **information activities**, including advisory services, in particular to small- and medium-sized industries. They are most effective when they are developed and implemented in close cooperation with industry. A notable example of this kind of program—among others—is the Canadian National Energy Business Program which provides computer-equipped buses to carry out energy audits and give on-site energy conservation advice. Canada has agreed to a close cooperation with the European Community in order to establish similar advice systems in Europe.

With respect to longer term RD&D programs, a recent report prepared for the Battelle Pacific Northwest Laboratories, which compared U.S. industrial energy conservation RD&D programs with those in West Germany, France, England, Sweden, and Japan, concluded that:

The U.S. Government will probably spend more, in absolute terms, on industrial energy conservation RD&D in 1981 than any one of the four European countries considered.

At the same time, the U.S. Government will spend less than any one of the four European countries per unit of industrial activity. For example, the expenditure of Swedish Government

funds per unit of industrial activity is 22 times the U.S. expenditure.²⁶

These findings and others in the Battelle study are supported by a report prepared for DOE by DHR, Inc.²⁷ The Battelle and DHR studies also point out that foreign RD&D is often cost-shared with industry to ensure the earliest possible commercialization and that project funding is seldom awarded on a competitive basis. In addition, foreign governments place greater emphasis than does the U.S. Government on developing technologies for export and in encouraging conservation in industries that must compete in international markets.

Implications for the United States

An important conclusion to be drawn from comparing U.S. industrial energy use with that in other developed nations is that considerable latitude exists for making U.S. industry more energy efficient, but not to the extent that a simple comparison of energy/GDP ratios would suggest. The United States could clearly benefit from foreign conservation research programs and could learn from foreign energy-using practices, but it would be incorrect to assume that foreign experience provides an easy path to decreased U.S. energy use.

In addition, when historical energy cost differences are taken into account, higher U.S. energy intensities generally do not imply economically inefficient or wasteful practices by U.S. industry. Rather, they indicate rational responses to socially dictated energy price signals. Foreign experience provides considerable evidence that energy use is responsive to energy prices, at least over the long run. Thus, an increase in price may have the effect of reducing energy use, but not necessarily on a short time scale. It is this delayed impact of higher energy prices that has led almost all IEA countries to introduce complementary conservation measures.

²⁶ "Government-Sponsored Industrial Energy Conservation Research, Development, and Demonstration: A Review of Programs in the Federal Republic of Germany, France, United Kingdom, Sweden, and Japan," Hagler, Bailly, & CO., Aug. 6, 1981 (Battelle contract No. B-B41 54-A-H).

²⁷ *Conservation and Solar Energy R&D Expenditures. An International Comparison*, DHR, Inc., Nov. 9, 1981 (DOE contract No. DE-AC01-81CE10097).

Chapter 4 The Pulp and Paper Industry

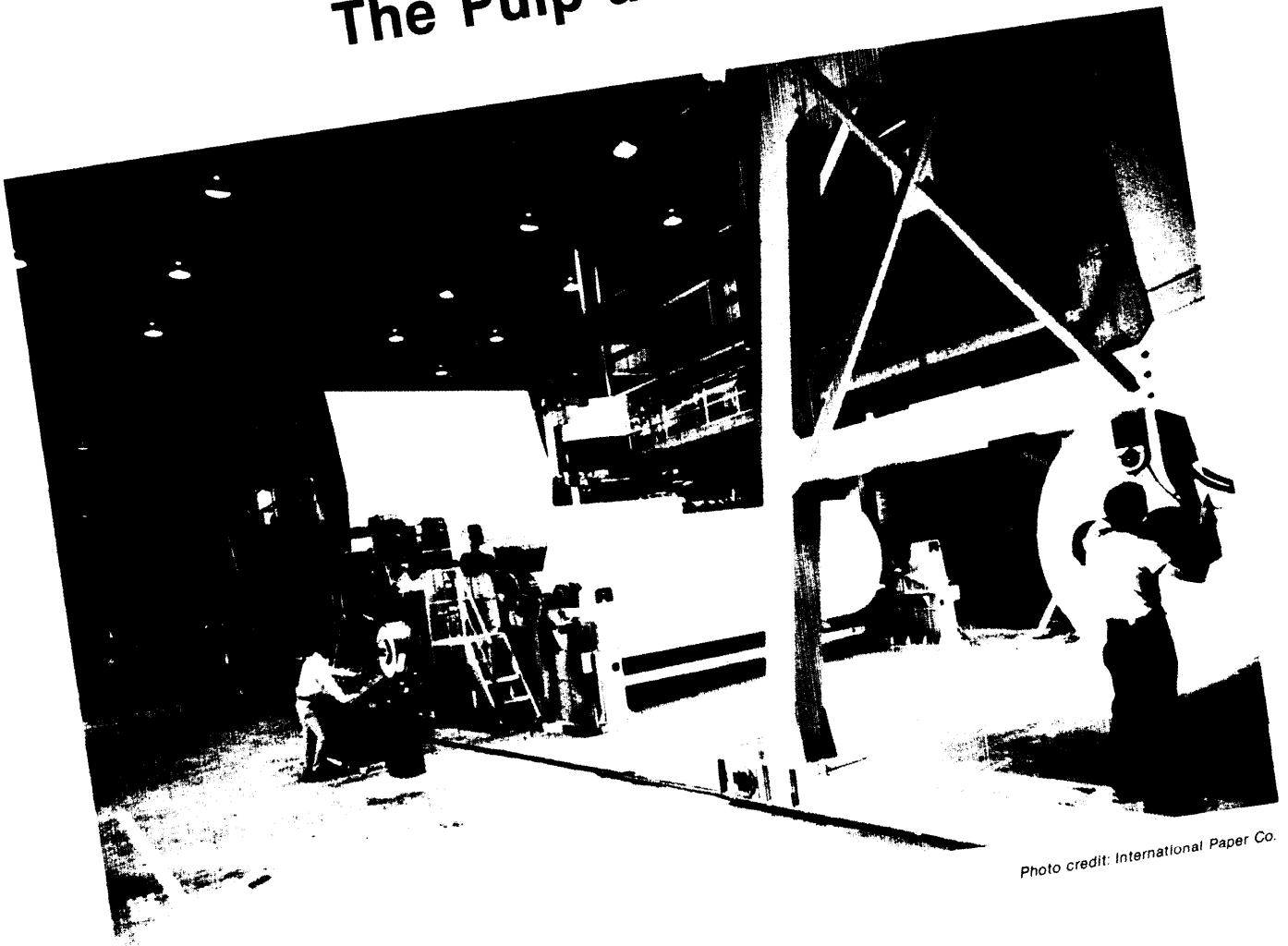

Photo credit: International Paper Co.

Contents

| | <i>Page</i> |
|------------------------------------------------------|-------------|
| Industry Overview | 65 |
| Industry Structure | 65 |
| Product Mix | 66 |
| Economics of Paper Products Production | 66 |
| Energy and Technology | 67 |
| Production Processes | 67 |
| Energy Consumption | 71 |
| Energy Conservation | 73 |
| Investment Choices for the Paper industry | 73 |
| Impact of Policy Options on the Paper industry | 75 |
| The Reference Case | 75 |
| Projected Effects of Policy Options | 77 |

TABLES

| <i>Table No.</i> | | <i>Page</i> |
|------------------|-----------------------------------------------------------------------------------------------|-------------|
| 14. | Definition of SK 26-The Paper and Allied Products Industry | 65 |
| 15. | Paper Corporations Earning More Than \$1 Billion in 1981 | 66 |
| 16. | Pulp and Paper industry Projects To Reanalyzed for internal Rate of Return (IRR) Values | 74 |
| 17. | Effects of Policy Options on IRR Values of Paper Industry Projects., | 75 |
| 18. | Overall Production and Energy Demand Trends in the Paper Industry | 76 |
| 19. | Projected Product Mix Changes in the Paper Industry | 76 |
| 20. | Effect of Lower interest Rates on IRR Values of Paper industry Projects. | 80 |

FIGURES

| <i>Figure No.</i> | | <i>Page</i> |
|-------------------|------------------------------------------------------------------------------------|-------------|
| 11. | Paper Industry Revenue eat Capital Expenditures, 1970-82 | 66 |
| 12. | Paper Industry Employment, 1969-79 | 67 |
| 13. | Materials Flow in an Integrated Papermill | 68 |
| 14. | Paper Industry Trends, 1972-81 | 72 |
| 15. | Changing Fuel Mix in the U.S. Paper Industry, 1972-81 | 72 |
| 16. | Comparison of Paper Industry Energy Use and Production Output, 1972 and 1981 | 73 |
| 17. | Paper industry Energy Intensity Projection, 1970-2000 | 77 |
| 18. | Paper industry Projections of Fuel Use and Energy Savings, 1990 and 2000..... | 7a |

The Pulp and Paper Industry

INDUSTRY OVERVIEW

The pulp and paper industry is the 11th largest manufacturing industry in the U.S. industrial sector, but is the third largest energy consumer. Unlike other industries, however, the pulp and paper industry can generate a large percentage of its energy needs through the use of wood residue. As a result, the industry is in a unique position to reduce its purchased energy costs, as well as its vulnerability to fuel shortages and/or disruptions.

As the world's largest producer of paper and board, the U.S. paper* industry accounted for roughly 35 percent of the world's total output and produced over 62 million tons of paper and board products in 1981. The value of industry shipments in 1981 dollars totaled over \$35 billion.¹ In addition, the United States has the highest per capita paper and board consumption in the world.

Industry Structure

The paper and allied products industry, classified under SIC heading 26, includes firms that produce and market pulp, paper and paperboard, packaging, and building paper and board. The subgroups of this industry are listed in table 14.

This report focuses on the three most energy-intensive industries within this SIC group: pulp, paper, and paperboard mills. Although building products and lumber are not examined further in this chapter, it is important to remember that the pulp and paper industry is closely tied to, and is becoming integrated with, these industries. Accordingly, management and investment decisions are often based on strategic business criteria that extend beyond making pulp and paper.

The paper industry is generally organized into integrated and non integrated mills. Vertical in-

Table 14.—Definition of SIC 26—The Paper and Allied Products Industry

SIC 26 includes the manufacture of pulps from wood and other cellulose fibers and from rags; the manufacture of paper and paperboard; and the manufacture of paper and paperboard into converted products such as paper coated off the paper machine, paper bags, paper boxes, and envelopes.

SIC 26 contains the following subgroups:

| SIC | Title |
|----------|---------------------------------------------------------------------|
| 261..... | Pulpmills |
| 262..... | Papermills, except building papermills |
| 263..... | Paperboard mills |
| 264..... | Converted paper and paperboard products except containers and boxes |
| 265..... | Paperboard containers and boxes |
| 266..... | Building paper and building board mills |

SOURCE: Office of Management and Budget, *Standard Industrial Classification Manual*, 1972.

tegration (i.e., producing raw materials as well as finished products) is common among the companies in the paper industry because various industry activities are often complementary. Vertical integration often begins with timber, the most common raw material, and culminates in distribution centers that assure finished product outlets. Integrated mills start with raw timber, which is processed onsite into finished paper. Nonintegrated mills either: 1) produce marketable pulp from raw timber, or 2) secure pulp from available markets and convert it into finished paper products. Based on the 1977 Census *of Manufactures* data, about 80 percent of U.S. market pulp originates in nonintegrated mills and about 20 percent in integrated mills.²

Currently in the United States, 400 companies operate more than 1,000 papermills and pulp-mills. Since World War II, the U.S. paper industry's primary productive capacity has been progressively concentrated in large new mills located in the South: roughly 65 percent of pulping capacity and 50 percent of papermaking capacity are now below the Mason-Dixon line. The secondary or converting sectors of the industry,

*The word "paper" is used as shorthand for "pulp and paper" throughout this report. Also, the term "ton" is shorthand for the more precise, "air-dried ton."

¹U.S. Department of Commerce, U.S. *Industrial Outlook 1982*, p. 45.

²Ibid., p. 40.

³*Directory of the Paper and Allied Products Industry*, Lockwood Publishing Co., 1981.

on the other hand, locate plants close to large metropolitan markets throughout the United States.^{4 5}

The paper industry has a relatively low level of concentration. No company has captured more than 10 percent of the market. Efficient production of paper can be done at a mill throughput of 300 tons per day. (The largest mill, Union Camp, located in Savannah, Ga., produces 3,000 tons per day.) This wide range of efficient production is one of the reasons the industry remains fragmented. Table 15 lists a number of corporations that earned over \$1 billion and used at least 1 trillion Btu of energy for the production of pulp, paper, or paper products in 1981.

Product Mix

The products of the paper industry are extremely varied. While paper has retained its traditional uses throughout the centuries—newsprint, writing papers, tissues, etc.—new uses and applications are continually evolving. The growth of the industry during the past few decades has been due largely to new applications and uses of paper and paper-based materials.

Economics of Paper Products Production

Product Demand

Because the paper industry has a wide spectrum of end products, its growth patterns closely resemble those of the general economy. While some sectors of the product mix are more closely related to changes in industrial activity, others are more directly affected by changes in levels of personal income or by demographic factors. Combined overall consumption of paper and board has closely tracked the changes in the gross national product (GNP).^{6 7}

⁴U. S. Industrial Outlook, 1982, op. cit., p. 39.

⁵H. N. Hersh, *Energy and Material Flows in the Production of Pulp and Paper*, Argonne National Laboratory Publication ANL/CNSV-10, February 1981.

⁶U.S. Industrial Outlook 1982, op. cit., p. 40.

⁷U. S. Industrial Outlook 1982, op. cit., p. 39.

Table 15.—Paper Corporations Earning More Than \$1 Billion in 1981

| Corporation | Revenues (in billions) | Employees |
|----------------------------------|---------------------------|-----------|
| Georgia Pacific | \$5.02 | 44,000 |
| International Paper | 5.00 | 46,000 |
| Weyerhaeuser | 4.53 | 49,000 |
| Champion International | 3.75 | 42,300 |
| Crown-Zellerbach | 3.07 | 32,000 |
| Mead Corp. | 2.71 | 25,000 |
| St. Regis | 2.71 | 29,700 |
| Kimberly-Clark Corp. | 2.60 | 31,200 |
| Scott | 2.08 | 20,800 |
| Union Camp | 1.57 | 16,097 |

SOURCE: Standard and Poor's Register of Corporations, Directors and Executives, vol. 1, 1983.

Capital Investment

Sales, profits, and retained earnings were high in the 1970's when the industry operated close to a supply/demand balance, an important factor in the performance of a capital-intensive industry. This approach led the industry to invest substantial and increasing amounts of its revenue in new capital, an amount that rose from 8 percent in 1970 to over 11 percent in 1980. However, in the face of high interest rates, a depressed timber market resulting from few housing starts, and the like, this ratio has declined slightly (fig. 11),

Like other manufacturing industries, the paper industry is very sensitive to environmental regulations on air and water quality. Between 1973 and

Figure 11.—Paper Industry Revenue and Capital Expenditures, 1970-82

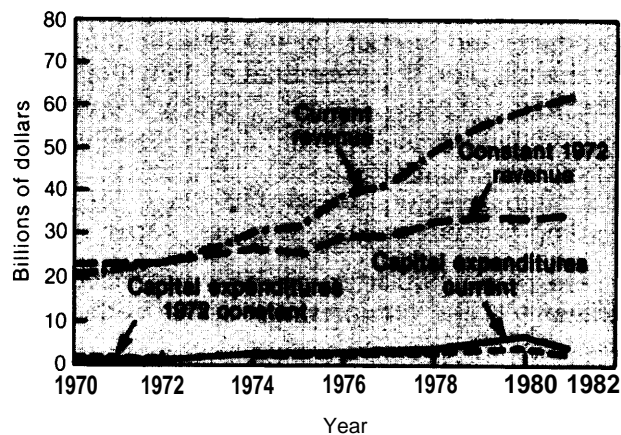

SOURCE: American Paper Institute,

1981, the industry reportedly spent a total of \$37.6 billion to comply with these regulations. The added capital requirements for new pollution abatement facilities, mainly centered in pulping activities, increased the capital-intensive character of the industry. B

Imports and Exports

In 1981, the U.S. paper industry, a major exporter of pulp and paper products, exported some 3.7 million tons of pulp valued at \$1.8 billion (current), and an estimated 4.43 million tons of paper and board valued at \$2.18 billion (current).⁹ In the same year, the United States also imported almost 10 million tons of pulp and paper products, relying heavily on newsprint and pulp imported from Canada. In the past 2 years, however, the margin of the U.S. paper industry trade deficit has narrowed because of relatively larger export volumes and an upgraded export product mix.¹⁰

High prices for energy and raw materials have forced Western European and Japanese producers to cut their production capacity. Japanese producers, for example, plan to phase out 1.1 million

⁹U.S. *Industrial Outlook 1982*, op. cit., p. 45.

⁹U.S. *Industrial Outlook 1982*, op., cit., p. 39.

¹⁰U.S. *Industrial Outlook 1982*, op. cit., p. 44.

tons of paper industry capacity by 1985 because of huge increases in the prices of wood chips imported from the United States and of oil imported from Indonesia and the Middle East. This decline in foreign production capacity has opened up new export markets for U.S. papermakers, thereby providing a cushion against domestic demand fluctuations.

Employment

Employment in the paper industry has been very steady over the last 10 years. Both sales and tonnage have risen during this time, so the flat employment profile can be attributed to automation of the mills with its corresponding increases in worker productivity (see fig. 12).

Figure 12.—Paper Industry Employment, 1969-79

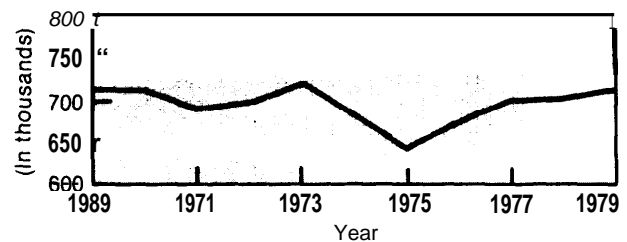

SOURCE: Argonne National Laboratory, *Energy and Materials Flows in the Production of Pulp and Paper*, May 1981

ENERGY AND TECHNOLOGY

Production Processes

Paper is made by separating the cellulosic fibers in wood and then removing the lignin that binds the fibers (pulping). The cellulose fibers are usually further conditioned—often by bleaching and refining—before being interlaced in sheets. Finally, water is removed from the sheets by mechanical pressing and the application of heat, leaving the final product, paper (see fig. 13). Many small companies use purchased pulp to begin their paper forming process.

The following is a brief description of the major processes in the paper manufacturing process, including energy's role. It should be noted that

process control is included under its own heading because it covers all phases.

Pulping

Pulping is energy-intensive, using about 4.5 million Btu per ton (MMBtu/ton) of paper. Commercial pulping operations are of three principal types: mechanical, full chemical, and semichemical.¹¹ The method of pulping used by a mill depends on the input (kind of trees) and the desired output (products). Within these constraints, the

¹¹McGraw.Hill Encyclopedia of Science and Technology, vol. 9, 1977, p. 609.

Figure 13.—Materials Flow in an Integrated Papermill

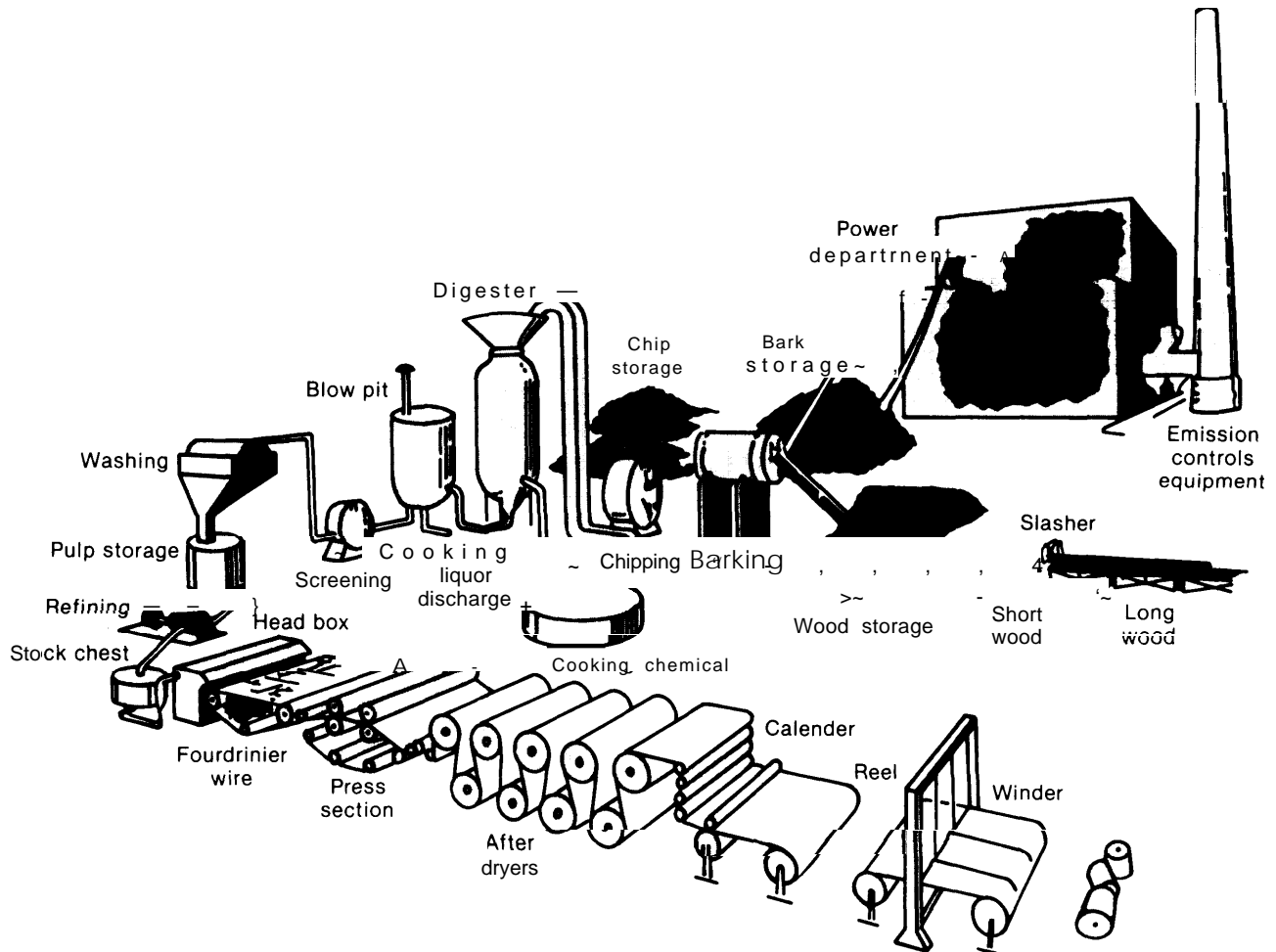

SOURCE: National Science Foundation

pulping processes on the basis of energy and raw material costs, as well as utilization rates, labor intensity, and ancillary costs, such as pollution control.

Mechanical pulping involves the reduction of wood to fibrous states by purely mechanical means. In the traditional stone groundwood pulping, logs are first ground into pulp by large revolving grindstones, while water is sprayed against the stone to control the temperature and carry away the resulting pulp. Except for a few water-soluble components, all the constituents of the wood remain in the pulp; thus, the yield of pulp may be nearly 95 percent of what was originally in the tree. Thermomechanical pulping (TMP),

which uses pressurized disk refiners in conjunction with heat and occasionally chemicals, is replacing the standard groundwood process fairly rapidly. It requires more purchased energy, and its yields are slightly lower than with conventional groundwood pulp, but the very important property of pulp strength is nearly that of semichemical pulp. Moreover, the process can use residual chips from sawmills and plywood plants as its raw material.

Full chemical pulping employs chemicals to separate cellulose fibers from other wood components. Wood chips are cooked with chemicals in an aqueous solution, usually at elevated temperatures (170° C or 350° F) and pressures, to

dissolve lignin and other compounds and leave the cellulose intact and in fibrous form. Dry pulp yields are in the range of 40 to 60 percent of wood dry weight. The kraft, or sulfate, process is the chemical pulping process most extensively employed. It uses sodium hydroxide (NaOH) and sodium sulfide (Na_2S) to solubilize the lignin. Almost any wood species can be pulped by this process.

Semichemical pulping is relatively new. It involves softening the wood with mild chemical action and then mechanically grinding it into pulp. Semichemical pulping is employed largely, but not exclusively, on deciduous wood species.

Significant processes in pulping include TMP, alkaline-oxygen pulping, and continuous digesters. Although TMP requires more energy to produce a ton of pulp than does the conventional groundwood method, it is likely to be used by the industry because it produces higher product quality and lower overall cost. On the other hand, alkaline-oxygen pulping uses only about half the energy as the conventional pulping and bleaching process and has the advantage of less sewage waste and the potential to recover more of the chemicals used. Unfortunately, it produces a weaker pulp than does the standard kraft process.

The continuous digester uses approximately 60 percent of the steam required by batch digesting systems. Because it also produces a higher quality, uniform pulp, its adoption within the industry is spreading. Its only disadvantage is its high cost of maintenance.

Bleaching

Pulp must be bleached if it is used to make white paper. The object of bleaching is to render the pulp white without degrading the cellulose. Some grades of paper need not be bleached at all (such as corrugated cardboard boxes), while others (newsprint) are given only light bleaching. Better grades of printing and writing papers require bleaching.¹²

Almost all bleaching is carried out with chlorine or chlorine compounds, leaving an effluent containing high levels of chemicals that must be

¹²Ibid

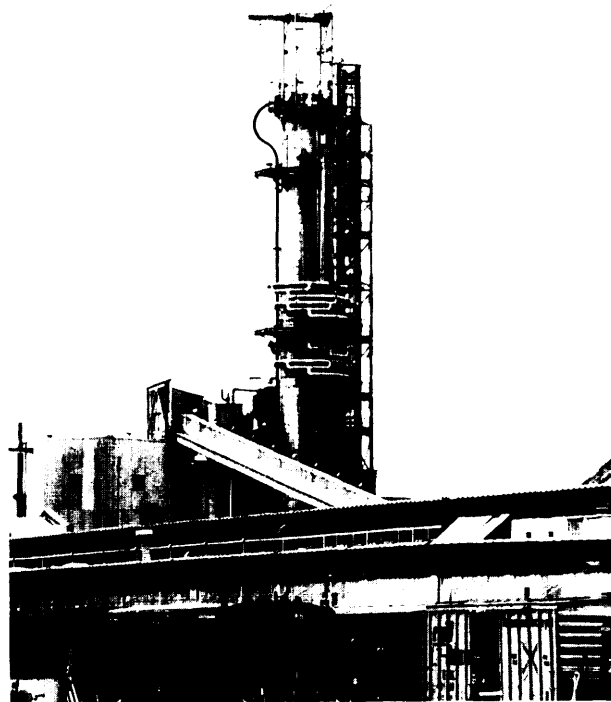

Photo credit International Paper Co.

Wood chips and chemicals are cooked in continuous digesters which break down the wood fiber so that it can be made into pulp and paper

biologically degraded at a sewage treatment plant. In addition, bleaching is an energy-intensive step that requires 5 MMBtu/ton of paper and increases the energy intensity of papermaking by 20 percent. Accordingly, mills have become attentive to ways to reduce energy and chemical losses in the bleach plant.

A number of new bleaching technologies are available to the industry, and some others are under development. Again, as with pulping, these new technologies have both advantages and disadvantages that have to be weighed before their adoption. Most of the new bleaching methods (e.g., the Rapson process, displacement bleaching, and compact bleaching) all appear to have the advantages of reduced energy consumption, and some have the added advantage of using less chemicals. On the other hand, some of these technologies suffer from deficiencies such as extremely high maintenance costs and corrosion. Some have not yet been proven in the American marketplace.

Refining and Repulping

The refining process is the stage of stock preparation that occurs after bleaching but before papermaking. During this stage the proper mixture of pulp types is blended. Recycled waste-paper also enters the paper stream at this stage for repulping. During refining, the unmodified cellulose fibers (obtained from pulping) are separated, crushed, frayed, fibrillated, and cut. They imbibe water and swell, becoming more flexible and more pliable.

The major energy source in the refining and repulping operations is electricity, which is used to operate motors. The primary way to conserve energy would therefore be to install newer and more highly efficient electrical motors.

Papermaking

In forming paper, up to 95 percent of the water has to be removed from the cellulose mixture. This process is the single most energy-intensive process in the entire papermaking operation, requiring up to 40 percent of the total energy used. Paper sheets are made by depositing a cellulose mixture, with a consistency of less than 1 percent cellulose solids suspended in water, on a continuously moving screen and subjecting it to one of the following three methods for removing the water: the Fourdrinier process, the cylinder machine, and the twin-wire former.¹³

In the Fourdrinier process, a dilute (water content of 99 percent or higher) suspension of cellulose fibers is sprayed under pressure onto a moving wire screen. As the slurry travels away from the spraying point, it passes over several suction devices that cause water to drain through the screen. As water is removed, a wet sheet is formed. The wet sheet is transferred to a supporting felt, which carries it through a series of press rolls. There, water is squeezed out and the sheet progresses to the dryer section. The remaining water is removed by evaporation as the sheet passes over a series of steam-heated cylindrical dryers which expose alternate sides of the sheet to hot dryer surfaces.

A second papermaking technique involves use of a cylinder machine to make multilayer paper-board. It differs from the Fourdrinier process only in the forming. In place of the moving screen are one or more rotary cylindrical filters. Each screen-covered cylinder is mounted in a vat where it operates partially submerged in the dilute papermaking slurry being supplied to it. As the cylinder revolves, water drains through the screen to the interior of the cylinder and a wet sheet is formed. The sheet is removed at the top of the cylinder and may be joined to other wet sheets from adjacent cylinders to form a thicker, laminated sheet or board. The press section and dryer processes are essentially the same as those following the Fourdrinier process.

The third major sheet-forming device is the twin-wire former, which is an outgrowth of the Fourdrinier process. Here the sheet travels vertically between wire screens that contact both sides of the sheet, forcing water out in both directions.

It is far more expensive to remove water thermally in the dryer section than physically in the press section or screen, because evaporation is much more energy-intensive. New techniques to increase moisture removal include such items as twin-wire forming and extended nip presses, where savings of up to 0.5 MMBtu/ton, or more, are possible. However, in some instances, it is possible to damage the cellulose fibers by excessive squeezing.

Another technology being developed is the high-consistency forming of paper, where the cellulose content is raised from below 1 percent to 3 or 4 percent, consequently reducing the water that has to be evaporated. Several other technologies have been developed for facilitating the removal of moisture on the machine, including drying hoods, fans, and other devices designed to remove the evaporated moisture from the proximity of the paper so that further moisture can be evaporated. These developments notwithstanding, the basic design of the papermaking machine itself has changed little over the last 100 years.

¹³ *Ibid.*, p. 610.

Recovery Operations

Chemical pulping processes also entail a recovery cycle in which valuable chemicals are reduced and returned to the digester. After digestion of pulp, a black liquor is drained off that consists of lignin, spent chemicals, and water. In a device (unique to the paper industry) called a recovery boiler, lignin carried within the spent pulping liquor is burned as fuel to generate steam while the sodium compounds used in pulping and beaching are recovered and reused. The considerable amount of energy produced in a recovery boiler and used in the recovery cycle has motivated some new conservation technologies.

The recovery cycle of a papermill may be as simple as a bark boiler at a groundwood mill or as complex as the Rapson process in a kraft mill. In the conventional kraft mill, the centerpiece of the recovery activity is the recovery boiler, which burns the organics (mostly lignin) as a black liquor, while recovering the valuable sodium chemicals.

Unfortunately, the black liquor, with its high water content (85 percent), will not burn. In order to reduce the water content in the black liquor, multieffect evaporation systems, with their high inherent coefficients of performance, have been adopted. Vapor recompression is starting to make inroads, although this technology is highly dependent on the cost of the electricity required to drive the system.

Process Control

Process control is a computerized monitoring and control of process variables that can save energy and materials and improve efficiency in almost every aspect of the paper industry. For example, either batch or continuous digesters are installed with a computerized process control system as standard equipment, and in the bleach plant, a process control system can increase uniformity of the bleached pulp. Moreover, process controls improve the throughput of the papermaking machine and have saved 1 to 2 percent of the total drying energy as well.

However, process control applications in paper are limited because the most important measurement points are often in harsh or inaccessible en-

vironments. For this reason, cooking rates in the digester (which contains a mixture of wood chips, chemicals, and steam) have been very difficult to measure, but research among instrument manufacturers continues to focus on this. optimum cooking rates would produce higher quality pulp with minimum expenditure of energy and time. For other control tasks where the necessary measurements have been achieved, productivity has risen in every case.

Unified control, which coordinates and schedules component processes, is now catching the attention of the paper industry. Its chief advantage is the reduction of overall production costs. Although this system is now available from control system vendors, the introduction of full mill control is progressing only gradually because of its large cost.

Energy Consumption

Energy consumption in the paper industry varies from year to year and from region to region. The total energy consumed in any given year is determined by a variety of factors, including availability and price of fuel, product mix, and capacity utilization. In 1981, the pulp and paper industry consumed 2.15 Quads of energy, one-half of which was internally generated from wood residues.

According to the American Paper Industry (API), during the period 1972-81 the paper industry's percentage of internally generated energy rose from 40.5 to 50 percent. Figure 14 shows this improvement clearly. As fossil fuel prices continue to escalate, more waste recovery programs will be introduced or expanded, and the industry will likely become even more self-sufficient. Already, many paper companies now find it economical to use the bark of the logs at the mill for fuel. Likewise, more and more sawdust is used as fuel,

The amount of energy purchases from utilities or other fuel suppliers is down by 6 MM Btu/ton from the 1972 levels, also shown in figure 14. Total purchased energy for 1981 was about 1.06 Quads. The latest API figures show that natural gas is the leading purchased fuel, followed by coal and residual oil (see fig. 15). The fuel used

Figure 14.—Paper Industry Trends, 1972-81

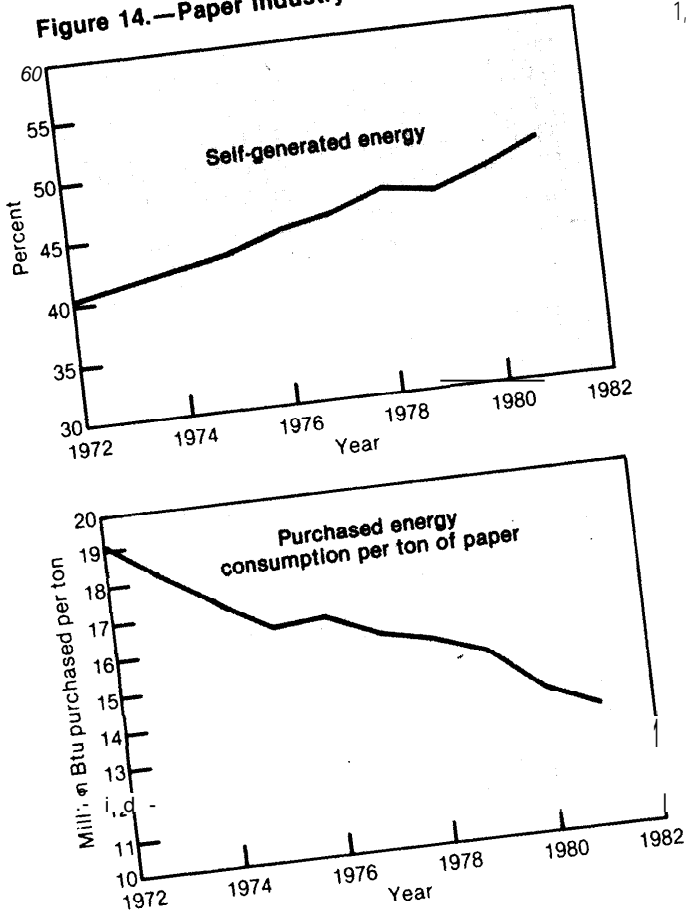

SOURCE: American Paper Institute.

Figure 15.—Changing Fuel Mix in the U.S. Paper Industry, 1972-81

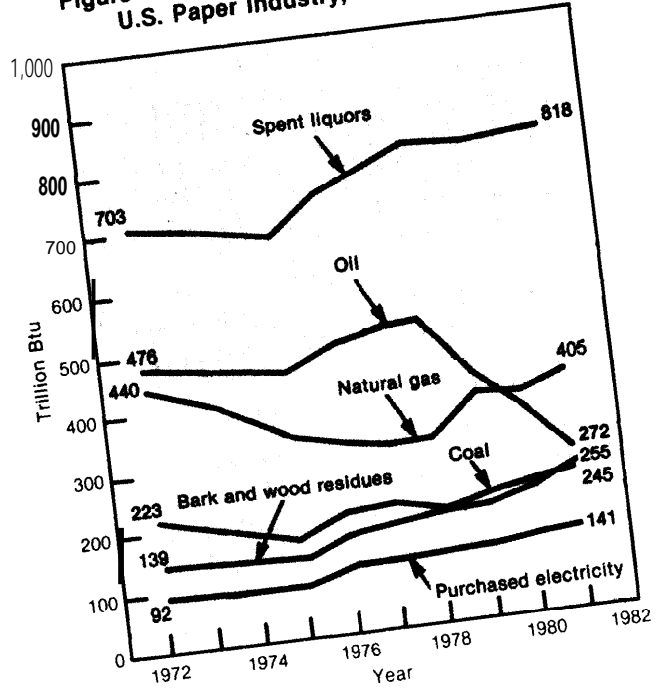

SOURCE: American Paper Institute



Photo credit: International Paper Co.

part of the mill's environmental protection
 portion of a mill's energy needs by
 burning waste behind, looms recovery
 'end in the foreground is boiler, which can meet a significant
 Ction burning 'rem 'he 'recess

in a particular mill is determined by the availability and cost of energy in a region.

Fuels are used by pulpmills and papermills to generate steam or electricity, large quantities of which are used to produce paper. The amount of energy needed to produce a ton of paper from wood averages about 30 MMBtu. This figure can be broken down more precisely by process and by product. The most energy-intensive step in papermaking is the drying process, followed by pulping and bleaching.

Not surprisingly, many mills have the capacity to cogenerate electricity. The paper industry has in place approximately 3.5 billion watts of cogeneration capacity, virtually all of which is in the form of steam turbine generators.¹⁴

Energy Conservation

As part of the Department of Energy's Office of Industrial Programs effort, the paper industry adopted a voluntary goal of 20-percent reduction in energy consumed per ton of product by 1980. According to API, by 1981, the industry was using 23.3 percent less purchased energy, while at the same time, productivity had increased by almost 20 percent. This is shown clearly in figure 16.

Many of the new pulp and papermaking processes and their associated equipment offer great potential for saving even more energy. Because new processes and equipment require large capital outlays, the rate at which conservation technologies are deployed will be largely dependent on the paper industry's ability to raise capital.

Given the steep fuel price rises of the 1970's, and their maintenance or escalation in the 1980's, it is safe to assume that energy conservation will continue to play a major role in the paper industry. Perhaps the greatest potential for reducing

¹⁴Ibid., p. 609.

Figure 16.—Comparison of Paper Industry Energy Use and Production Output, 1972 and 1981

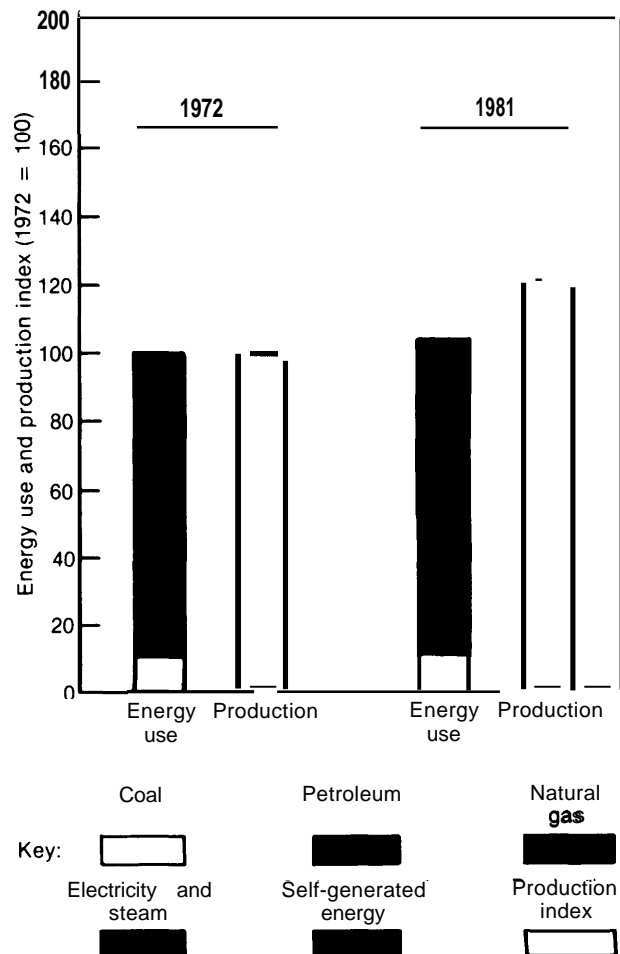

SOURCE: American Paper Institute

oil and gas consumption in the paper industry lies in increasing the industry's use of wood residue as fuel for the integrated producers. For those firms that produce paper from purchased pulp, such fuel sources do not exist. Instead, their improvements will come from more efficient production.

INVESTMENT CHOICES FOR THE PAPER INDUSTRY

In general business operations, the paper industry is similar to other industries. It strives to maintain reasonable cash flow, and its investment strategies are designed to preserve the company

and maintain or improve its profitability to its shareholders. It attempts to preserve its asset values, maintain creditworthy balance sheets, and, of course, produce profits. However, al-

though the individual paper companies are basically dependent on the same raw material inputs, their end products and markets are extremely diverse. These products can range from heavy linerboards to fine writing papers to tissue paper. This diversity further increases divergent subjective and objective opinions of management, for the marketplace of one major forest products company could be completely different from the marketplace of another.

In one respect, the paper industry could be considered slightly different from other industries. The major pieces of equipment used in this industry have exceedingly long lifetimes. Fifty years is considered a reasonable retirement age for a lime kiln, and some parts of paper machines running now are over 100 years old. Therefore, investment decisions in the paper industry are often

viewed over much larger horizons of time than in other industries.

There are a number of possible investment opportunities in energy conservation and other areas for the paper industry that appear financially attractive (see table 16). OTA reviewed eight such investments, ranging from those made specifically to save energy, to those with the secondary benefit of saving energy, and finally to those that do not save energy and, in fact, compete with energy-saving technology for corporate investment dollars. Furthermore, the opportunities examined provide examples of discretionary expenditures to satisfy very short-term problems and to remove bottlenecks, as well as capital expenditures to install new machinery or to initiate a research and development project to increase market share.

Table 16.—Pulp and Paper Industry Projects To Be Analyzed for Internal Rate of Return (IRR) Values

- | | |
|--------------------------------------------------------------------------------------------------------------------------------------------------------------------------------------------------------------------------------------------------------------------------------------------------------------------------------------------------------------------------------------------------------------------------------------------------------------------------------------------------------------------------------------------------------------------------------------------------------------------------------------------------------------------------------------------------------------------------------------------------------------------------------------------------------------------------------------------------------------------------------------------------------------------------------------------------------------------------------------------------------------------------------------------------------------------------------------------------------------------------------------------------------------------------------------------------------------------------------------------------------------------------------------------------------------------------------------------------------------------------------------------------------------------------------------------------------------------------------------------------------------------------------------------------------------------------------------------------------------------------------------------------------------------------------|------------------------------------------------------------------------------------------------------------------------------------------------------------------------------------------------------------------------------------------------------------------------------------------------------------------------------------------------------------------------------------------------------------------------------------------------------------------------------------------------------------------------------------------------------------------------------------------------------------------------------------------------------------------------------------------------------------------------------------------------------------------------------------------------------------------------------------------------------------------------------------------------------------------------------------------------------------------------------------------------------------------------------------------------------------------------------------------------------------------------------------------------------------------------------------------------------------------------------------------------------------------------------------------------------------------------------------------------------------------------------------------------------------------------------------------------------------------------------------------------------|
| <p>1. Inventory control—A computerized system can keep track of product item availability, location, age, and the like. In addition, these systems can be used to forecast product demand on a seasonal basis. The overall effect is to lower inventory, yet maintain the ability to ship products to customers with little or no delay. In typical installations, working capital costs are dramatically reduced. Project life—5 years. Capital and installation cost—\$560,000. Energy savings—O directly, but working capital could be reduced by \$1.2 million.</p> <p>2. Electric motors.—The primary use of electric motors in the paper industry is in paper machine operations. In this analysis, OTA has assumed that five aging electric motors will be replaced with newer, high efficiency ones. Project life—10 years. Capital cost and installation cost—\$35,000. Energy savings—\$16,000 per year at 4¢/kWh.</p> <p>3. Lime kiln replacement—Replacement of an aging unit which thermally converts calcium carbonate waste chemical back to chemical oxide (lime) suitable for further chemical processing of pulping liquors. Project life—20 years. Capital and installation cost—\$11 million. Energy saving—\$1 million in first year.</p> <p>4. R&D project.—A hypothetical research effort to develop a new paper-coating process. Project life—3 years. R&D costs—\$1.4 million. Plant construction cost at end of 3 years of development—\$57 million. Energy savings—O directly but new market could generate \$50 million per year in increased profits.</p> | <p>5. Pulpmill cogeneration project.—Installation of a turbogenerator unit to recover electrical power from steam production facility. Superheated steam is produced at 600 psi and then passed through a mechanical turbine to generate electricity. The turbine exhaust, which is 175 psi steam, is used then for normal plant production. Project life—10 years. Capital and installation cost—\$231,000. Energy savings—\$72,300 per year.</p> <p>6. Continuous digester.—Equipment for new, innovative process for generating pulp. Project life—20 years. Capital and installation cost—\$27 million. Energy savings—\$3.7 million in first year.</p> <p>7. Computerized process control—The most common retrofit purchases being made for industrial systems are measuring gauges, controlling activators and computer processors. The main accomplishment of such a process control system is to enhance the throughput and quality of a chemical production plant with only materials and small energy inputs. Project life—7 years. Capital and installation costs—\$500,000. Profit savings—\$150,000 per year.</p> <p>8. New papermaking machine.—A new pulp processing, papermaking facility including buildings, machinery, and installation. Project life—20 years. Capital and installation costs—\$350 million. Energy savings—O directly, but profits could be increased by \$60 million per year.</p> |
|--------------------------------------------------------------------------------------------------------------------------------------------------------------------------------------------------------------------------------------------------------------------------------------------------------------------------------------------------------------------------------------------------------------------------------------------------------------------------------------------------------------------------------------------------------------------------------------------------------------------------------------------------------------------------------------------------------------------------------------------------------------------------------------------------------------------------------------------------------------------------------------------------------------------------------------------------------------------------------------------------------------------------------------------------------------------------------------------------------------------------------------------------------------------------------------------------------------------------------------------------------------------------------------------------------------------------------------------------------------------------------------------------------------------------------------------------------------------------------------------------------------------------------------------------------------------------------------------------------------------------------------------------------------------------------|------------------------------------------------------------------------------------------------------------------------------------------------------------------------------------------------------------------------------------------------------------------------------------------------------------------------------------------------------------------------------------------------------------------------------------------------------------------------------------------------------------------------------------------------------------------------------------------------------------------------------------------------------------------------------------------------------------------------------------------------------------------------------------------------------------------------------------------------------------------------------------------------------------------------------------------------------------------------------------------------------------------------------------------------------------------------------------------------------------------------------------------------------------------------------------------------------------------------------------------------------------------------------------------------------------------------------------------------------------------------------------------------------------------------------------------------------------------------------------------------------|

NOTE: All projects are assumed to be financed from equity. Fuel is assumed to rise in cost slightly faster than inflation. Depreciation follows the ACRS schedule, and there is a 10 percent general investment tax credit, but no energy tax credit.

SOURCE: Office of Technology Assessment.

These projects can be ranked according to several criteria, among which are the internal rates of return (IRRs). As shown in the reference case column of table 17, the project with the highest rate of return, 90 percent, is inventory control. Project IRR values descend thereafter to a low of 13 percent with the new papermaking machine. Thus, if one were to invest purely on the basis of maximizing returned moneys to a corporation and its shareholders, the inventory control project would be the first one undertaken. However, there are other criteria by which proj-

ects can be ranked. For instance, the project that saves the greatest amount of energy per dollar invested is the replacement of the electric motors. And if one were to rank the projects based on the total energy saved, the continuous digester would come out on top, with a savings in energy equivalent to over 80,000 barrels of oil per year. However, its \$11 million cost is by no means insignificant and illustrates the point that those projects that save large amounts of energy have large costs associated with them as well.

Table 17.—Effects of Policy Options on IRR Values of Paper Industry Projects

| Project | Reference case | IRR with policy option | | |
|-------------------------------|----------------|------------------------|-----------------|-----------------------------------------------------|
| | | ACRS removed | 10-percent EITC | \$1/MMBtu tax on natural gas and petroleum products |
| Inventory control | 90 | 90 | 90 | 90 |
| Electric motors | 47 | 47 | 52 | 50 |
| Lime kiln | 31 | 28 | 34 | 32 |
| R&D (no R&D credit) | 28 | 26 | 28 | 28 |
| Continuous digester. | 21 | 20 | 21 | 25 |
| Process control | 20 | 20 | 25 | 22 |
| Cogeneration | 15 | 13 | 18 | 15 |
| Paper machine | 13 | 12 | 15 | 13 |

NOTE: All projects are assumed to be financed from equity.

SOURCE: Office of Technology Assessment

IMPACT OF POLICY OPTIONS ON THE PAPER INDUSTRY

This section of the report describes the projected impact of each of the legislative options described in chapter 1. Although the projections for total fuel use and overall energy efficiency in the pulp and paper industry are included, the goal of this section is to present comparisons of each policy option with a reference case. The reference case projections are predicated on a series of product growth-rate assumptions and energy price assumptions, previously shown in tables 2 and 3 of chapter 1. The basic premise is that industrial electricity prices will remain constant for the last 15 years of this century, while petroleum and natural gas prices will rise at an overall rate of approximately 2.1 percent per year.

The Reference Case

OTA's model projection of the volume of shipments and energy demand in the pulp and paper

industry is shown in table 18. There are several interesting points to be noted on the table. First, total energy is projected to rise at about 1 percent per year from its 1980 level of 2,180 trillion Btu to approximately 2,620 trillion Btu in the year 2000. Purchased energy will decline slightly from 52 to 47 percent, owing primarily to the increased use of coal and electricity. However, purchased fuel use per ton of paper will likely decline from its 1980 level of 20 MMBtu/ton to a level of 11.6 MMBtu/ton by 2000, as shown in the last column of table 18.

Within the paper industry the three major means of pulping wood (i.e., chemical, semi-chemical, and mechanical) were projected to maintain the approximate pulping percentages they now enjoy. However, recycled pulp is expected to grow from its 1980 level of 23 percent of total pulp production to 25 percent by 2000,

Table 18.—Overall Production and Energy Demand Trends in the Paper Industry (Reference Case)

| Year | Paper shipments (million tons) | Total energy (trillion Btu) | Purchased energy (trillion Btu) | Purchased/ total energy (percent) | Total MMBtu/ton of output | Purchased MMBtu/ton of output |
|------------------------------------------------------------|-----------------------------------|--------------------------------|------------------------------------|-----------------------------------------|---------------------------------|-------------------------------------|
| 1980..... | 63.8 | 2,180 | 1,130 | 52 | 34.2 | 20.1 |
| 1985..... | 71.2 | 2,150 | 1,100 | 51 | 30.2 | 15.4 |
| 1990..... | 82.0 | 2,280 | 1,140 | 50 | 27.8 | 13.9 |
| 2000..... | 106.1 | 2,620 | 1,230 | 47 | 24.7 | 11.6 |
| Average growth rate, 1980-2000 percent per year..... | 2.54 | 0.92 | 0.42 | | | |

SOURCE: Office of Technology Assessment

since the supply of virgin pulpwood appears to be unconstrained.

The mix of products produced in 1980 in the paper industry is shown in table 19, along with the products' anticipated growth rates. Comparing the 1980 (actual) and 2000 (projected) product slates indicates that printing and writing papers will increase their percentage, while construction, paperboard, and packaging percentages will decline. This is a trend seen in other industries that have a higher growth in the more value-added products and a fall-off in production of basic commodity products.

OTA analysis of the impact of each legislative option is illustrated with the data on IRR calculations shown in the legislative option columns of table 17. In this exercise, IRR calculations are initially made for each project in the series, assuming reference case conditions of equity financing, accelerated cost recovery system (ACRS) depreciation, etc. Then IRR values are recalculated under the conditions of the legislative options. Several points should be noted about the projects listed and the numbers calculated.

First of all, the IRR fails to consider the other questions that go into making a decision about each project. For instance, notwithstanding the tremendous savings in energy efficiency that would come about in the lime kiln replacement, there is no way in which an energy saving of \$1 million a year can, by itself, justify a \$11 million expenditure. However, in this instance (based on a real case), the firm was faced with expenditures of \$4.0 million to overcome pollution problems and a cost of \$1.0 million necessary for repair of the existing kiln facility. While energy savings certainly increased the attractiveness of the new kiln, the about-to-be-imposed Federal environmental restrictions on the existing facility were felt by management to be the main motivating factors.

IRR calculations also fail to show the magnitude of the risk associated with the new paper-making machine. A new facility costing \$350 million, no matter how high its IRR value, would be closely scrutinized from a strategic standpoint. The economics of this type of project depends highly on such factors as the perception of market demand and product competition. The cost of energy plays a secondary role.

Table 19.—Projected Product Mix Changes in the Paper Industry

| | 1980 product ion (million tons) | Relative growth rate (% per annum) | Product mix ⁽¹⁰⁰⁾ | |
|-----------------------------------------|---------------------------------------|------------------------------------------|------------------------------|------|
| | | | 1980 | 2000 |
| Newsprint ^a | 4.67 | -0.5 | 7 | 7 |
| Printing and writing ^b | 15.60 | 1.3 | 24 | 31 |
| Packaging..... | 5.54 | -1.4 | 9 | 7 |
| Tissue..... | 4.30 | -0.2 | 7 | 7 |
| Paperboard..... | 30.95 | -0.3 | 49 | 45 |
| Total..... | 63.62 | | 100 | 100 |

^aThe growth in domestic production incorporates a correction for relatively declining imports.

^bCoated papers are about 30 percent of this category.

SOURCE: Office of Technology Assessment.

Strictly speaking, cogeneration falls in the category of discretionary investment and can be viewed as a technology installed entirely to reduce energy costs, although if the electricity network is poor in an area, it could also carry some economic value in security of supply. Compared to a discretionary investment with a lower rate of return (e.g., the continuous digester), it does not necessarily follow that the cogeneration facility would take preference. Much depends on the marketplace and whether bottlenecks in production are more important to management than is a reduction in energy costs. Here again, the highest return on investment may not necessarily attract the corporate dollar.

In the case of the process controller on a paper machine, different functions are involved. Process controllers may be designed either to increase machine speeds and therefore output or to produce a uniform quality, saleable product, thereby reducing waste and increasing output. A reduction in energy use inevitably occurs when a process control system is installed—e. g., if less waste were produced, the energy input per ton of saleable output would also be reduced,

The case of the electric motors illustrate an important point concerning replacement of existing equipment. If a motor must be purchased, and the choice is between a standard model or a high-efficiency one, the investment in the latter produces an IRR of 46.6 percent. However, if the existing motors need not be scrapped, and replacement is to be justified purely on energy savings, the return on investment would drop to 14.6 percent, which includes the targeted tax credit favoring the high-efficiency motors. Even if the existing motors were to be replaced in 5 years, the IRR would reach only 18 percent, which includes the investment tax credit of 10 percent. All economic justification for this type of project must thus be realized from the savings in electrical energy.

It is obvious from this example that energy savings alone cannot overcome the financial realities associated with prematurely scrapping equipment. Therefore, even though the energy savings per dollar invested are the highest of all the technologies discussed in this section of this

report, it is unlikely that replacement of existing motors would be high on the list of any paper company's discretionary spending investments.

The point here is not to discount IRR calculations, but to illustrate that other factors besides the return can enter into the decision whether or not to undertake a project.

Projected Effects of Policy Options

The following sections illustrate the projected effects of the four policy options in comparison with changes in energy demand and energy intensity in the reference case. Figures 17 and 18 present a graphical overview of the impact of these policies.

Two things are immediately apparent in the diagrams. First, as shown in figure 17, the average energy intensity for the paper industry (in million Btu per ton) is projected to decline from its present level of about 35 to a level of 26 in 2000. And, as shown in figure 18, the amount of fuel used is expected to increase to 2,620 trillion Btu over the same time period. That is, the trend of the industry, assuming the fuel prices originally shown in table 2, will be toward more efficient production of paper.

Option 1: Removal of Accelerated Depreciation

The passage of Public Law 97-34 in August 1981 brought several significant benefits to industry.

Figure 17.—Paper Industry Energy Intensity Projection, 1970-2000

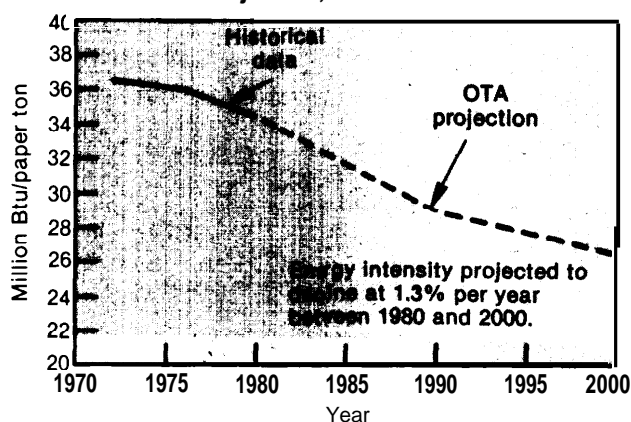

SOURCE: Office of Technology Assessment

Figure 18.—Paper Industry Projections of Fuel Use and Energy Savings, 1990 and 2000

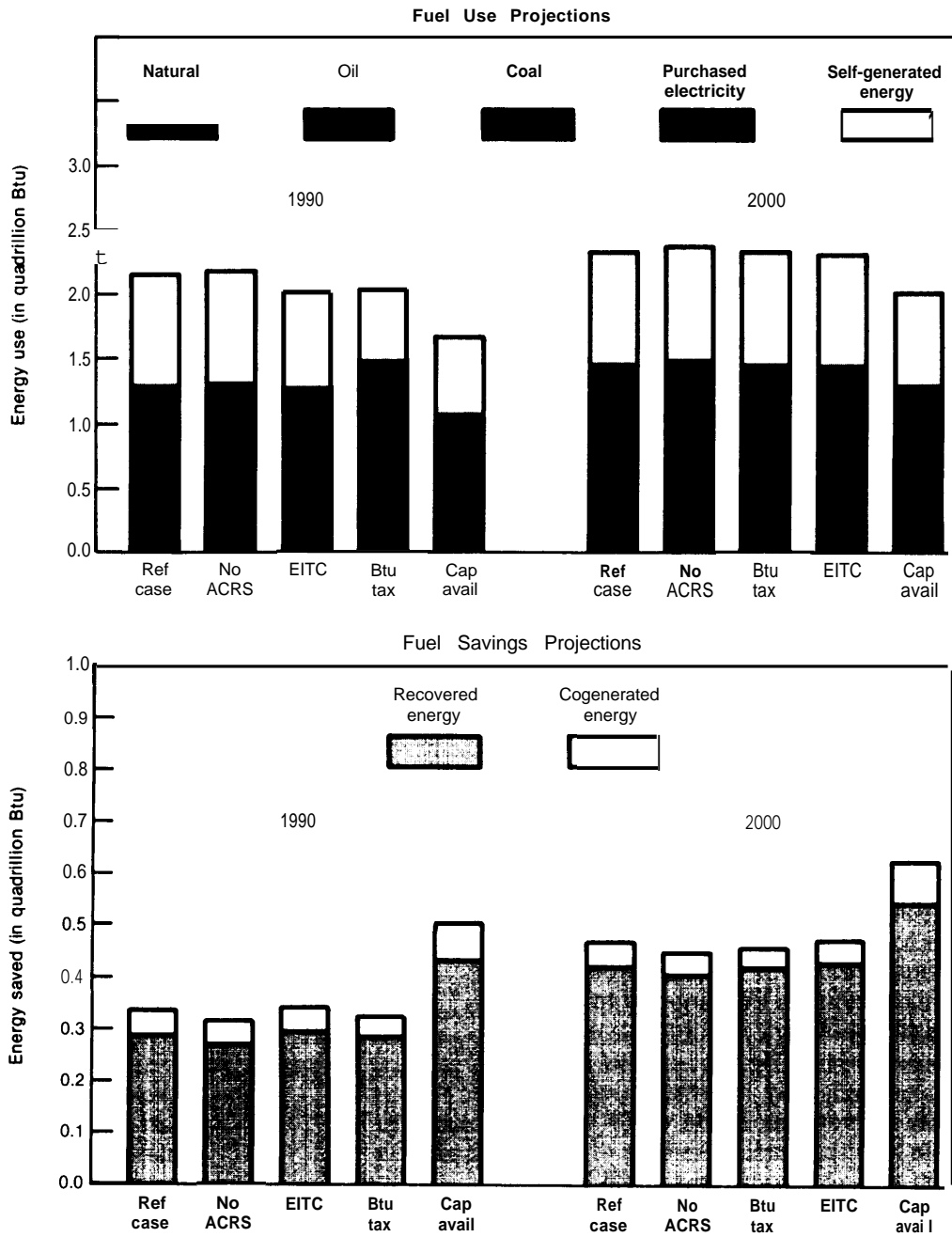

SOURCE: Office of Technology Assessment.

For the paper industry, the new rules put buildings into a 10-year depreciation lifetime category, and all pulping and papermaking equipment into a 5-year category. This is in contrast to the previous situation wherein this equipment would be in the 15- to 20-year lifetime.

If the ACRS were removed, OTA analysis indicates that the effect on energy use would be minimal. Total energy use would increase from a projected level of 2,820 trillion to 2,840 trillion Btu, an overall change of 0.7 percent. This would occur because ACRS allows a corporation to defer its tax liability, but does not remove the obligation.

Table 17 illustrates the effect of this policy option on the IRR of the eight paper industry projects described previously. OTA analysis using these IRR calculations indicates that none of the eight projects shifted their positions relative to the other projects. Each project changed the IRR value only 1 to 3 percentage points. Overall, removal of ACRS would make slightly less money available for corporate use, but that the effect on paper industry energy intensity would be negligible.

Option 2: Energy Investment Tax Credits

The second policy option, a targeted energy investment tax credit (EITC), would be used by corporations to offset a part of their Federal income tax. In the paper industry, the items benefiting most from such tax credits would be cogeneration systems and computer control systems for either steam boilers or paper production. Large units such as digesters, whose primary purpose is other than to save energy, will not, in all likelihood, qualify for a tax credit. The existing list of qualified equipment will also include heat recovery equipment, evaporators, and black liquor preparation systems.

In conducting its analysis, OTA found that all corporations take advantage of tax credits that are available to them, but in no instance was a tax credit found to be the deciding influence in whether or not to undertake an energy efficiency-improving project.

As illustrated in table 17, when this option is applied to the reference case, only one of the projects moves up in position. The process controller moved ahead of the continuous digester by 4 points. Investing in the continuous digester undoubtedly results in a significant increase in capacity, whereas a process controller most likely results in an increase in the efficiency with which existing equipment is used. One means making more pulp, while the other means making better pulp. The influences on the first project reflect management's perception of the demand of the market for more product, or, in the second case, for a better product. A tax credit, while not without impact, is only one factor influencing the choice between the two projects.

Previously in figure 18, OTA presented its analysis of the impact of a tax credit on total paper industry fuel use and overall energy efficiency. As shown in the EITC case compared to the reference case, there is projected a slight drop in total energy demand from 2,819 trillion to 2,809 trillion Btu in 2000. Most of that would come from decreases in natural gas use. Energy intensity of the paper industry is projected to be virtually unchanged, i.e., 24.7 MMBtu/ton in both the reference and EITC cases.

Overall, OTA analysis indicates that the influence of a small EITC on the paper industry would not be significant.

Option 3: Tax on Premium Fuels

Of the four industries examined in this study, paper uses by far the most self-generated energy. Wood residue produced 50 percent of the energy used in pulp and paper production in 1981. This trend toward self-generation of energy has been in existence for at least the past decade, which means that purchased energy now used by this industry cannot be easily supplanted by self-generated energy.

Thus, the premium fuels tax option does not have much impact on fuel use patterns. As shown in figure 18, the impact would be greatest on natural gas, where consumption is forecasted to decrease 7 to 8 percentage points. However,

since natural gas accounts for only 20 percent of the fuel used by the paper industry, the impact of the natural gas decrease on total energy use is small. OTA analysis does indicate a slight decrease in cogenerated electricity production with a Btu tax, since much of the commercially available cogeneration equipment is based on natural gas use.

The use of TMP processes would be influenced by a premium fuels tax to the extent that utilities are dependent on these fuels to produce electricity, since electricity is the main source of energy for TMP processes. The Pacific Northwest has seen a dramatic rise in the price of its hydroelectricity, from \$0.005 to \$0.03 per kilowatt-hour. The initial impact of this energy price rise has been to make Canadian pulp more attractive.

A Btu tax on gas and oil would cost the paper industry approximately \$600 million annually, which would translate to an approximately \$7/ton increase. Much of this would be passed on to customers of the industry, but it is not clear that all can be.

The effect on the IRR of a fuel tax of \$1 .00/MMBtu is shown in table 17. Comparison of the case with the Btu tax case shows that the largest gain was with the continuous digester, where the IRR value increased from 21 to 25 percent. However, as noted previously, many factors enter into the decision to build a continuous digester facility. The fact that the energy consumed by an existing batch digester is subject to a tax will not by itself motivate a company's managers to invest in a new continuous digester. But, if the batch system must be replaced, a tax may contribute to the decision to upgrade the system.

The overall result is that the fuel tax is not enough to reorder the priorities of this collection of projects. Although the fuel-intensive projects advanced in the IRR with a sudden increment in price, they did not advance enough to displace higher ranked projects. Of course, it would be possible to pick a different slate of projects that shows more motion. The conclusion by OTA for the paper industry is that a fuel tax of \$1 .00/MMBtu will not solely be effective in motivating energy conservation investments.

Option 4: Low Cost of Capital

OTA analysis indicates that capital is constrained in the paper industry not so much by the interest rates charged by commercial institutions for loans, as by the overall economy and the ability of firms to sell their products. As discussed in chapter 2, capital for investment in energy projects or any other project comes from a combination of borrowing and net profits. There are many things that can decrease a company's capital pool size if that pool is derived mainly from internal funds. To the extent that internal funds are used for capital investment, interest rates will have no effect on whether a project is undertaken. However, in many companies the interest rate is used as the discount rate in IRR calculations, and so interest rates may affect IRR values.

In many firms, the capital pool is comprised of a combination of internal and borrowed funds. In these cases, there is the opportunity for interest rates to influence the decision of whether to invest in a project or not. However, OTA has found that even here, the decision is comprised of many factors besides energy conservation and the cost.

The eight paper industry projects illustrate quite well the small change that would be exhibited by the IRR calculations for this policy option. For these calculations, OTA assumed that the projects were financed by one-third equity moneys, and two-thirds debt funding (see table 20). The first column shows what the IRR value is when

Table 20.—Effect of Lower Interest Rates on IRR Values of Paper Industry Projects^a
10% Inflation, ACRS, 10%/0 ITC)

| Project | Reference case | IRR with |
|-----------------------------------|---------------------|---------------------|
| | 16%/0 interest rate | 10%/0 interest rate |
| Inventory control | 389 | 373 |
| Electric motors | 75 | 79 |
| Lime kiln | 47 | 52 |
| Process control | 33 | 41 |
| R&D (with 25%/0 credit) | 34 | 35 |
| Continuous digester | 22 | 23 |
| Cogeneration | 17 | 20 |
| Paper machine | 13 | 17 |

^aProjects are assumed to be two-thirds debt financed and one-third equity financed.

SOURCE: Office of Technology Assessment.

the interest rate is 16 percent, while the second presents these same calculations with an **8** percent interest rate. IRR values rise by 4 to 5 points in each case, * which is in the range of uncertainty for these projects. And, not only do the projects rise only a small amount, but also none of the projects changes place.

Figure 18 shows the OTA projections on fuel use under the terms of this legislative option. Of the four options, this one is projected to have the greatest effect. Energy use would drop from 2,81

*Except for inventory control, which goes down because the computer control saves working capital. When interest rates drop, the carrying charges on the working capital also drop, and therefore profitability drops slightly as well.

Quads in 2000 to 2.67. Much of that would result from increases in the recovered energy now being sent up stack gas flues and sent to thermal waste streams, and in cogenerated energy derived from waste fuel sources. This improved energy use comes from increased market penetration of relatively capital-intensive conservation and cogeneration technologies and is projected to cause a 15-percent drop in natural gas and petroleum use. Additionally, the growth in total electricity demand, owing to increased penetration of electrical technologies at the expense of generally less efficient, fossil fuel technologies, and the increased penetration of conservation devices cause overall energy consumption to decline while the product slate remains the same.

Chapter 5

The Petroleum Refining Industry

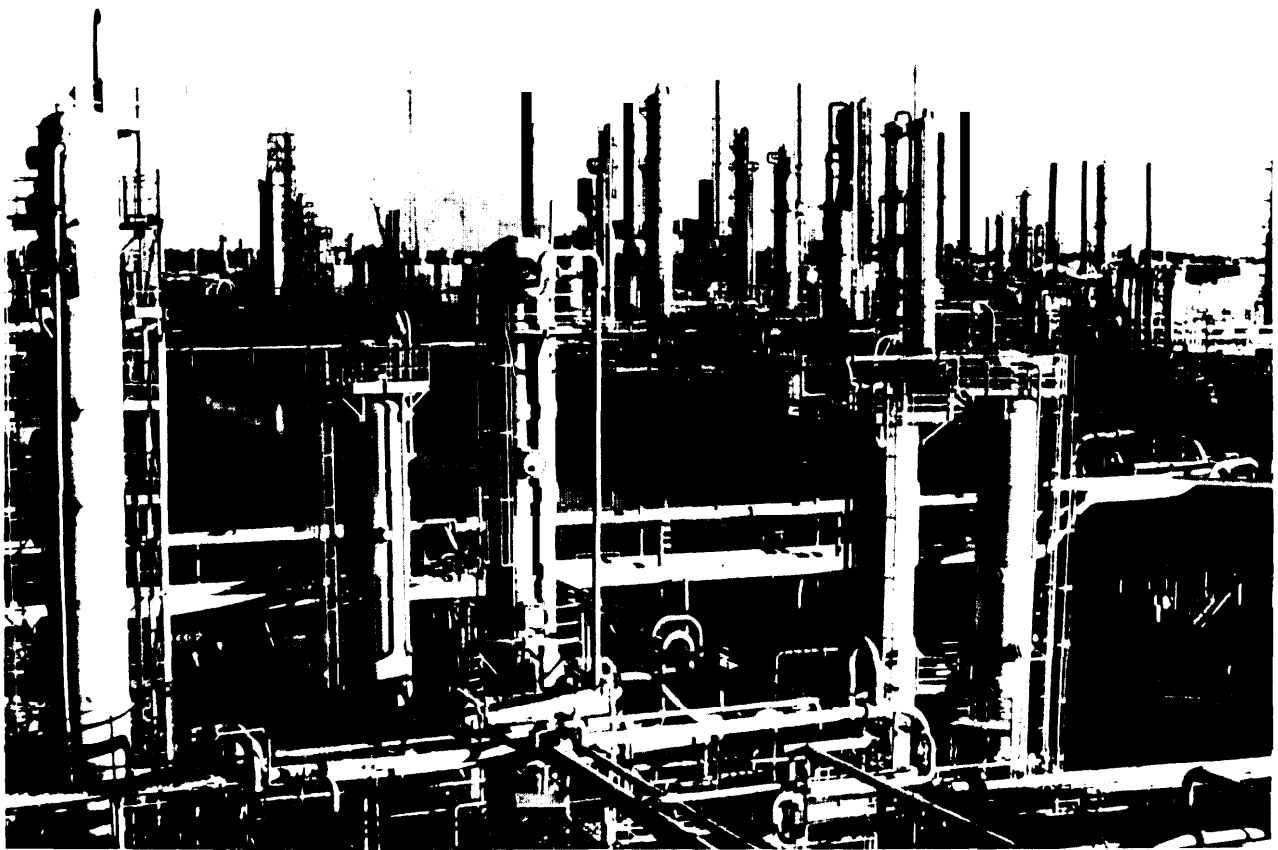

Photo credit American Petroleum Institute and Exxon Corp.

Contents

| | Page |
|--------------------------------------------------------------------|------|
| Industry Overview | |
| Industry structure....., | 85 |
| Product Mix | 86 |
| Economics of Refining .. ,.,. | 88 |
| Imports and Exports | 89 |
| Trends and Uncertainties..... | 90 |
| Energy and Technology..... | 92 |
| Production Processes | 92 |
| Kinds of Refineries | 94 |
| Energy Use | 95 |
| Energy Conservation | 97 |
| Potential for Energy Saving | 98 |
| Technologies for Increased Energy Efficiency | 99 |
| Proven Technologies for Energy Conservation | 99 |
| New Concepts in Refinery Energy Use | 101 |
| Investment Choices for the Refining industry | 104 |
| Capital Expenditures in the oil industry | 104 |
| Other Investment opportunities .P..... | 105 |
| Impacts of Policy Options on the Petroleum Refining Industry | 107 |
| The Reference Case | 107 |
| Projected Effects of Policy Options | 110 |

TABLES

| <i>Table No.</i> | <i>Page</i> |
|--------------------------------------------------------------------------------------------------------|-------------|
| 21. Definition of SIC 29-The Petroleum Refining and Related Industries | 85 |
| 22. Petroleum Refining Corporations Earning More Than \$16 Billion in 1981 | 86 |
| 23. Products Manufactured in SIC 29, | 87 |
| 24. Process Plant Construction Cost, 1972 and 1982. | 88 |
| 25. Comparison of 1972 and 1981 Energy Consumption in Petroleum Refining Industry. | 98 |
| 26. Petroleum Refining industry Projects To Be Analyzed for Internal Rate of Return (IRR) Values | 108 |
| 27. Projected Changes in Petroleum Refining Production Between 1985 and 2000.... | 110 |
| 28. Effects of Policy Options on IRR Values of Petroleum Refining Industry Projects.. | 111 |
| 29. Effect of Lower interest Rates on IRR Values of Petroleum Refinery Industry Projects | 112 |

FIGURES

| <i>Figure No.</i> | <i>Page</i> |
|------------------------------------------------------------------------------------------------------------------|-------------|
| 19. Employment Trends in Petroleum Refining Industry, 1970-82 | 89 |
| 20. Topping Refinery Model Configuration | 94 |
| 21. Hydroskimming Refinery Model Configuration | 94 |
| 22. Complex Refinery Model Configuration | 96 |
| 23. Alliance Refinery Energy Profile | 97 |
| 24. Comparison of Petroleum Refining Industry Energy Use and Production Output 1972 and 1981 | 98 |
| 25. Diagram of Atmospheric Fluidized-Bed Combustion Boiler/Combustor Arrangements. | 103 |
| 26. Petroleum Refining Industry Projections of Fuel Use and Energy Savings by Policy Options 1990 and 2000 | 109 |
| 27. Petroleum Refining Industry Energy Intensity Projection, 1970X)00. | 110 |

INDUSTRY OVERVIEW

The petroleum refining industry uses the largest quantity of premium fuels in the industrial sector, amounting to 2,7 Quads in 1981. ¹ It is second only to the chemicals industry in the total amount of energy it consumes. Classified under SIC 29, the petroleum refining industry is defined as the group of establishments engaged in refining petroleum, producing paving materials, and manufacturing lubricating oils. Its official description is shown in table 21.

This industry faces a future that bears little resemblance to its past. Previously, the firms that made transportation fuels for the United States had access to large quantities of high-quality crude oil. Now, they must use less desirable high-sulfur crude oils as feedstocks. The petroleum product market is changing as well. Environmental considerations require production of high-octane, unleaded gasoline, instead of gasoline with lead added to improve fuel quality.

In addition, the costs of fuel have risen to such levels that overall demand for refining products is projected to decline over the next two decades. Thus, the management of firms in SIC 29 finds itself in the unenviable position of having to make sizable capital investments in an industry whose product will be in less demand.

¹ American Petroleum Institute, *Energy Efficiency Improvement and Recovered Material Utilization Report to U.S. Department of Energy*, June 10, 1982, p. 2.

Table 21.—Definition of SIC 29—The Petroleum Refining and Related Industries

This major group includes establishments primarily engaged in refining petroleum, manufacturing of paving and roofing materials, and compounding lubricating oils and greases from purchased materials. This SIC group contains the following subcategories:

| SIC | Title |
|---------------|---------------------------------------------|
| 291 | Petroleum refining |
| 295 | Paving and roofing materials |
| 299 | Miscellaneous products of petroleum and oil |

SOURCE Office of Management and Budget, *Standard Industrial Classification Manual*, 1972

Finally, the refining process is becoming more complex as demand increases for high octane, unleaded gasoline. Crude petroleum, as found in nature, must be processed (refined) to remove impurities and to manufacture such useful materials as gasoline, jet fuel (kerosene), and fuel oil. In the early days of the petroleum refining industry, simple distillations were used to produce desired gasoline and kerosene products, with up to so percent of the crude oil feedstock being discarded. In recent years, this industry has made a great deal of effort to increase the yield of high octane products, minimize waste, and improve the overall quality of the product produced.

Industry Structure

The U.S. petroleum refining industry now consists of approximately 270 refineries owned by 162 companies.² Refineries are located in 40 of the 50 States. Refining capacity is located in areas known as Petroleum Administration for Defense (PAD) districts. Major concentrations of refining capacity exist in PAD districts 2 (Great Lakes and Midwestern States), 3 (Gulf Coast), and 5 (Pacific Coast). PAD district 1 (East Coast) has less refining capacity, a deficiency made up for by pipeline and tanker shipments from the Gulf Coast and by imports, primarily of residual fuel oil, from foreign Western Hemisphere refineries.³

As of January 1, 1982, the operating refineries in the United States had a total crude-running capacity* of about 17.7 million barrels per day (bpd), representing about 27 percent of the refining capacity of the non-Communist world.⁴ Processing from around 1,000 bpd to over 600,000 bpd, refineries range from "fully integrated" com-

²Ibid., p. 6.

³*International Petroleum Encyclopedia*, J. C. McCaslin (ed.) (Tulsa, Okla.: The Petroleum Publishing Co., 1981).

*The size of a refinery is normally expressed as its "crude capacity," meaning the number of barrels that can be "run" each day through its atmospheric distillation units.

⁴American Petroleum Institute, *Basic Petroleum Data Book*, January 1983.

plex plants, capable of producing a complete range of petroleum products, to small, simple refineries that can produce only straight-run distillates, heavy fuel oils, and sometimes asphalt. Small (less than 75,000 bpd) refineries make up about 60 percent of the total number of refining units, but their combined capacity is only about 24 percent of the total throughput. * In terms of ownership, the four largest companies have about 38 percent of the total refining capacity, and 20 companies have about 77 percent of the total refining capacity.⁵ The top 10 firms are shown in table 22.

There is no single, accepted method of categorizing the structure of the U.S. petroleum refining industry that captures the similarities and differences in refineries related to processing capabilities, access to feedstock supplies, ability to market, and the like. One grouping is:

1. **Large, integrated, multinational companies** typically have worldwide production, refining, and marketing operations in addition to their activities in the United States. A number of these firms are descendants of the Standard Oil companies created when Rockefeller's Standard Oil trust was dissolved in 1911.⁶ These major oil producers have typically had access to assured supplies of crude oil from the Middle East and other producing areas of the world. Such guaranteed sup-

plies of crude oil are diminishing as governments of the producing countries increasingly take over responsibility for disposing of their crude production. As a consequence, many of the U.S. multinational oil producers find that their domestic activities—including refining—are becoming more important to their financial health. These companies, with their sophisticated high-volume refineries, provide the bulk of the products manufactured through complex processing steps.

2. **Large- and medium-sized domestic refiners** make up a diverse group of companies. Some are fortunate in being largely self-sufficient in domestic production of crude oil. Others depend for their crude supply on some combination of long-term contracts and "spot" purchases. * They have much less total refining capacity than do the major firms, but a number of them are significant marketers in their own regions.
3. **Independent refiners** form the most diverse group of all. Most independent refiners are small, domestic companies. Refining is their principal operation; most do not produce crude oil and do not market their products under their own names.

Product Mix

A petroleum refinery is a complex assembly of individual process plants interconnected with piping and tanks. Each plant has a specific function,

*Throughput—the total amount of crude oil initially processed.
⁵*Oil and Gas Journal*, "Refining Capacity Dips on Broad Front," vol. 81, No. 12, Mar. 21, 1983, p. 84.

⁶U.S. House of Representatives, Committee on Energy and Commerce, *U.S. Refineries: A Background Study*, July 1980.

*Spot purchases are those made by refiners on the open market and without benefit of a contract.

Table 22.—Petroleum Refining Corporations Earning More Than \$16 Billion in 1981

| Corporation | Revenues (in billions) | Employees |
|-------------------------------------------------------|---------------------------|----------------|
| Exxon | \$110.06 | 137,000 |
| Mobil Oil | 60.33 | 82,000 |
| Texaco | 57.63 | 66,728 |
| Standard Oil of California (Chevron) | 46.61 | 43,000 |
| Standard Oil (Indiana) (Amoco) | 31.73 | 58,700 |
| Atlantic Richfield | 28.75 | 54,200 |
| Gulf Oil Corp. | 21.17 | 53,300 |
| Shell Oil Co. | 21.60 | 37,273 |
| Conoco | 16.29 | 34,500 |
| Phillips Petroleum Co. | 16.29 | 34,500 |

SOURCE: Standard and Poor's *Register of Corporations, Directors and Executives*, vol. 1, 1983

and each refinery has been built to process a certain type of crude oil (or "slate" of crudes) to produce the products required for a defined market.⁷ Markets for specific products change constantly, and existing refineries are modified or new refineries are built to accommodate such changes. In recent years, Government regulations, subsidies, and other influences (to be described later) have greatly affected both refinery operations and the construction of new refineries.

Refineries convert crude oils into a broad spectrum of products, most of which are fuels. A simple grouping of refinery fuels would include liquefied petroleum gases, gasolines, jet fuels, diesel fuels, distillate heating oils, and residual fuel oils. Refineries processing heavy crude oils may also produce asphalt and coke (see table 23). Refineries vary greatly in their size, processing complexity, and ability to use crude oils of differing characteristics.

⁷The Mellon Institute, *The Industrial Sector Technology Use Model*, final report, vol.3, *The Petroleum Refining Industry*, April 1982

An important aspect of the U.S. refining industry is its ability to produce basic petrochemicals—feedstocks for the manufacture of a wide variety of plastics, synthetic fibers, paints and coatings, adhesives, piping, and other products of modern society. Basic petrochemical materials manufactured by the U.S. refining industry from petroleum fractions and natural gas include such large-volume commodities as ethylene, methanol, and benzene and other aromatics. Until recently, it appeared that U.S. refineries could look forward to increasing markets for these materials. Now, however, the picture seems much less bright because the industry appears to be "overbuilt" for current market demands.⁸ Recent studies have concluded that current worldwide ethylene capacity is adequate to meet demands at least through 1985.⁹

⁸*Oil and Gas Journal* Mar. 21, 1983, op. cit., p. 85.

⁹*Chemical and Engineering News*, "Saudi Arabia Set To Emerge as Factor in World Marketplace for Chemicals," Dec. 20, 1982, p. 65.

Table 23.—Products Manufactured in SIC 29

| Product manufactured | Percentage of total 1980 production | Definition of product and uses |
|---------------------------|-------------------------------------|-----------------------------------------------------------------------------------------------------------------------------------------------------------------------------------------------------------------------------------------------------------------------------------------------|
| Gasoline | 39 | A refined petroleum distillate, normally boiling within the ranges of 30 to 300 C, suitable as a fuel in spark-ignited internal combustion engines. |
| Distillate fuel oils | 18 | A general term meaning those intermediate hydrocarbon liquid mixtures of lower volatility than that of kerosene, but still able to be distilled from an atmospheric or vacuum distillation petroleum refining unit. Used as boiler fuel in industrial applications, and as home heating fuel. |
| Residual fuel oil | 15 | The material remaining as unevaporated liquid from distillation or cracking processes. Used mainly as boiler fuel in powerplants, oceangoing ships, and so forth. |
| Aviation jet fuel | 6 | Specially blended grades of petroleum distillate suitable for use in jet engines. These fuels have high stability, low freezing points, and overall high volatility. |
| Petrochemical feedstocks | 5 | A broad term encompassing those refinery products, having typically low molecular weight and high purity (ethylene, propylene, and acetylene, which are used as feedstocks in chemical production of everything from food additives to textile fibers. |
| Liquefied petroleum gases | 4 | Light hydrocarbon material, gaseous at atmospheric pressure and room temperature, held in liquid state by pressure to facilitate storage, transport, and handling. CONSISTS primarily of propane and butane. Used in home heating. |
| Kerosene | 2 | A refined petroleum distillate, intermediate in volatility between gasoline and heavier gas oils used as fuels in some diesel engines. Often used as home heating fuel. |
| Other products | 11 | Includes items such as petroleum coke, petroleum solvents, lubricating oils and greases, asphalt, and the like. |

SOURCE *American Petroleum Institute Data Book*, published 1979, and *National Petroleum News*, December 1980

Economics of Refining

The economics of refining is now undergoing major changes. Existing refineries were built and expanded during a period of steady increase in market demand, accompanied by continuous, but moderately paced developments in refinery technology. The large integrated companies profited by the total price spread between their low-priced crude oil and the sales of refined products. Non integrated companies with access to crude oil supplies profited by refining this crude oil and disposing of the products in largely "unbranded" bulk markets. Others, without crude oil supplies of their own, but able to purchase crude oil on favorable terms, developed specialized refineries to supply regional markets, such as an Air Force base or commercial airport.

During these years of expansion, refinery operating costs were not considered critically important. Many in the industry were content to look at the "big picture" of the total spread between cheap crude costs and income from finished product sales. The cost of the refining operation, although certainly not insignificant, was only one of many costs in the series of steps between crude oil exploration and production and the delivery of products to the final consumer. The industry's profits came from high volumes of oil moved through the entire system, and refineries did what was necessary to keep this flow going.

Now the picture is changing. Some essential features of these changes can be summarized:

1. As product demand has leveled off or even decreased, the refining industry finds itself with more capacity than it can use. Many predict that this decrease in demand reflects a long-term trend.
2. Existing refineries, faced with the recent escalation in energy costs **and** the increasing need to break even or show an operating profit, are being forced to look much harder at ways to decrease operating costs, such as the more effective use of energy in refining processes.
3. "Margin a]" refineries, those that are expensive to operate or are poorly located with

respect to crude oil or markets, are being shut down—some temporarily, others for good. Although some employees will be transferred, most will be permanently laid off when a refinery closes.

4. Even if an individual company's market prospects or improvements in technology suggested that major new refinery process plants should be built, construction costs have escalated to the point that such new facilities in the United States would face capital carrying charges that would make it difficult to compete with existing refineries having surplus capacity. The increase in construction costs in the past 10 years for the three types of refineries are illustrated in table 24.
5. As a final deterrent to new "grass-roots" construction, siting problems—including the inevitable vigorous local environmental concerns—when coupled with increased costs, make it unlikely that a new refinery could be built in marketing areas where the capacity is needed (such as the Northeastern United States).

From the foregoing it appears safe to conclude that construction of a major new U.S. refinery is unlikely in the foreseeable future. Instead, the emphasis will largely be on adapting existing refineries to the changing patterns of crude supply and product markets (described in a subsequent section).

Employment

Employment in SIC 29 as a whole, or in SIC 2911, the petroleum refining industry itself, has been remarkably stable over the past decade. The trend, as shown in figure 19, exhibits the slight decrease during the 1972 and 1979 oil disruptions, but overall employment has been maintained at approximately 150,000 jobs.

Table 24.—Process Plant Construction Costs, 1972 and 1982 (thousands of dollars/bpd)

| | 1972 | 1982 |
|-----------------------------------|-------|-------|
| Topping refineries | 540 | 1,600 |
| Hydroskimming refineries. | 940 | 2,800 |
| Complex refineries. | 1,600 | 4,800 |

SOURCE Refinery Flexibility—An Interim Report of the National Petroleum Council, VOI 1, December 1979

Figure 19.—Employment Trends in Petroleum Refining Industry, 1970-82

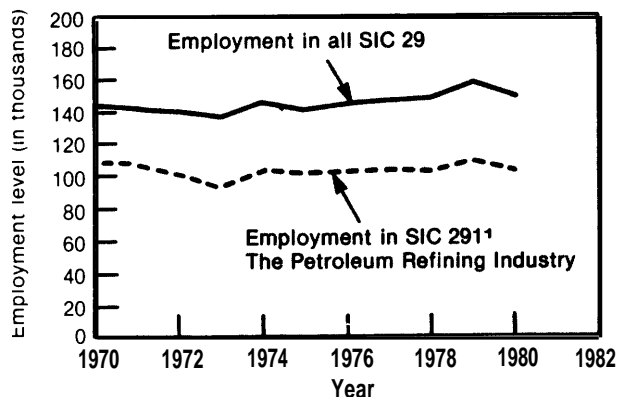

SOURCE Annual Survey of Manufacture and Census of Manufacture.

Production Costs

The operating costs of refineries are generally closely held figures. These costs depend greatly on the size and complexity of a specific refinery. They are normally expressed in terms of dollars per barrel of crude unit throughput. Such figures can be misleading, however, because larger, more complex refineries will incorporate process plants used for the relatively expensive processing required to make a few specialty or highly refined products. Simple topping refineries—and especially those of medium to large size—will have relatively low processing costs per barrel, but the value of their products will be correspondingly low in comparison to the much broader range of products from a more complex refinery.¹⁰

Capital Investment

For a further perspective on the economics of the oil industry, it is important to recognize that about 70 percent of capital spending in a typical SIC 29 firm goes for exploration and production activities. "Petroleum refining capital budgets must compete for the remaining 30 percent of available funds with petrochemicals manufacturing, marketing, oil and gas pipelines, and other activities.

In considering the ability of the refining industry to raise funds for new capital expenditures, including those for energy conservation, it should also be recognized that the profitability of the refining industry appears to be very questionable in the immediate future.¹² Because U.S. refineries are operating well below capacity, there is a downward pressure on refined product prices that will prevent many refiners from passing on to their customers all their costs, including crude cost.

As a final observation on the subject of oil refining economics, it should be recalled that since the early 1960's, the industry has been under various types of controls intended to aid—i.e., subsidize—small refiners. Under the original crude import control system of the 1960's, small refiners were given special allocations of "import tickets" that they could sell to large refiners who import their own foreign crude. In August 1971 additional subsidies for small refiners were put into effect.¹³ These included price controls on domestic crude oil, crude entitlement biases, small refinery set-asides for military businesses, guaranteed small business loans, U.S. royalty crude preference sales, naval petroleum reserve set-asides, mandatory crude allocations, and exemptions of small refiners from the scheduled phasedown of lead-octane additives.

As one result, this subsidy program established extremely attractive investment opportunities for very small, simple refineries, and many were quickly built. Very few of them could produce gasoline, and many used high-quality crude in the simple production of fuel oil instead of producing higher quality products. However, as of January 1981, all price and allocation controls were removed from crude oil and petroleum products.

Imports and Exports

Prior to the removal of price and allocation controls in January 1981, U.S. refiners were largely protected from foreign competition by a **system** of crude oil and product price controls.¹⁴ This

¹⁰National Petroleum Council 1, *Refinery Flexibility*, prepared for the U.S. Department of Energy, Washington, D. C., 1980, p. 18.
¹¹Standard Oil Co. of California, *1980 Annual Report*.

¹²*Oil and Gas Journal*, Mar. 21, 1983, op. cit., p. 85.

¹³National Petroleum Council, op. cit., p. 24.

¹⁴U.S. House of Representatives, Committee on Energy and Commerce, U.S. *Refineries: A Background Study*, July 1980.

program resulted in an average raw material cost for U.S. refiners that was below the price foreign refiners had to pay for their crude. As domestic crude oil price controls were phased out, the raw material cost advantage of the U.S. refiners began to disappear. The decontrol action eliminated the remaining advantage.

With its access to crude oil at worldwide competitive prices and an efficient domestic product distribution system, a vigorous U.S. refining industry should have little reason to fear foreign competition. All that seems to be required at this point is close monitoring by both Government and industry of the expansion of export refineries around the world, together with a continuing evaluation of how they might affect the U.S. refining industry if no control were exercised.

Refineries in Venezuela and the Caribbean area, for example, now supply somewhat over 1 million bpd of product to the U.S. market.¹⁵ However, residual fuel oil makes up most of these imports. These refineries have relatively little capacity to make gasoline and other light products, and it seems unlikely that they will invest in the very considerable conversion programs necessary for producing significant amounts of gasoline, jet, and diesel fuel to be marketed in competition with underutilized U.S. refineries.

Existing European refineries have considerable unused processing capacity, but to reach the U.S. market they must face the expensive transportation of refined products in small tankers. (The vessels of "supertanker" and larger size cannot practically be used to transport the mixed cargoes of light products that would be required in such movements.) Another major disadvantage faced by European refiners is the growing predominance of unleaded gasoline in the U.S. markets.

Unleaded gasoline of high octane is manufactured only in the United States. It appears most unlikely that European refiners could afford to invest in the additional catalytic reforming and other processes necessary to provide unleaded gasoline just for their share of the U.S. market.

In the long run, a more serious threat is production from very large petrochemical plants be-

ing built in areas where the basic raw materials are less costly (or will be made available by local governments at prices well below U.S. costs). Such plants are being built in Canada, Mexico, and—most significantly—the Middle East.¹⁶ Several such plants are being built at Jubail and Yanbu, in Saudi Arabia, by Saudi Government agencies and by joint ventures between these agencies and large foreign firms. These plants have been promised feedstocks and fuel at costs of only a fraction of world market prices. Although the plants are remote from current world markets, the industry anticipates that their low manufacturing costs will permit them to enter such markets, to the detriment of current producers. An analysis of transportation costs and potential markets indicates that finished products from newly constructed Middle East refineries will go primarily to Western Europe, presenting additional problems to the already depressed European refining industry. Another possibility is that the Middle East governments (notably Saudi Arabia) may require their crude oil purchasers to buy some refined products in order to be allowed access to crude oil.

Trends and Uncertainties

Refineries in the United States are experiencing drastic changes in the business atmosphere in which they operate. Available crude oil supplies are deteriorating in quality, motor gasoline use has been dropping sharply from historic highs, markets for many products are leveling out or declining, and Government-mandated changes (e.g., requirements for low-sulfur fuel oil, increasing use of unleaded gasoline, and the ultimate phaseout of leaded gasolines) require increasingly sophisticated and costly refining operations.

Refining capacity has probably peaked for the foreseeable future. Investment in refinery process plants will continue to be made, as necessary, to handle the growing amounts of heavy crude oil and the greater relative demand for unleaded gasoline of (perhaps) steadily rising octane number. The additional energy requirements of these

¹⁵National Petroleum Council, *op. cit.*, P. 223.

¹⁶*Chemical and Engineering News*, *Op. cit.*

new processes may affect the industry's ability to continue the recent trend toward more energy-efficient processing.

Details of these trends are discussed under the following topics and in subsequent sections of this analysis.

Crude Supply Uncertainties.— If the volumes of foreign crude oil imported into the United States continue to decrease, the industry and the Nation may become unjustifiably complacent about the perceived diminishing dependence on foreign crude oil. Short-term or even longer interruptions in the availability of Middle Eastern crude always remain a possibility.

Crude Oil Prices.—Crude oil prices quadrupled during the Arab oil embargo of 1973-74 and more than doubled again during the Iranian crises of 1978-80, in the early 1980's, worldwide crude oil prices declined as a result of production overcapacity and lowered demand.¹⁷ It is not clear what will happen to crude oil prices. Political upsets in the Middle East could result in crude oil embargoes or physical interruptions in crude oil availability, with consequent skyrocketing of prices worldwide. Also, reductions in crude oil prices, if unaccompanied by significant increases in production, could have a shattering effect on the economies and possibly on the internal stability of several of the highly populated, oil-producing nations.

Changing Crude Mix.—Much of the older refining capacity in the United States was designed to process crude oil of low sulfur content and medium-to-high quality. Available supplies of these crude oils are dwindling, both in the United States and elsewhere. Those OPEC countries having reserves of both light and heavy crudes are requiring their customers to take quantities of both types, instead of merely "lifting" predominantly the more desirable light crudes.¹⁸

As a consequence of this changing crude oil mix, U.S. refiners are being forced to make major investments in additional processes and new

facilities. These facilities involve heavy fuel oil desulfurization and coking, together with processes to recover the light ends given off in the coking operation. Modifications to permit processing heavy crude oil can be quite costly and energy-intensive. One U.S. refiner, for example, has announced a \$1 billion program to modify its Gulf Coast refinery so that it can process the Arabian heavy crude oil that it will be required to take as part of its share of ARAMCO* production.²⁰

Changing Product Demand.—The declining demand for refined products in the United States since 1978 seems permanent and is primarily a response to higher prices, the current lower level of economic activity, and the gradual introduction of more fuel-efficient small cars.²¹ Also, the trend of the refinery process mix will probably be away from motor gasolines and toward middle-distillate fuels. Yet it is not at all clear how much the U.S. demand for refined product will decline before it rises again (if it does). One major uncertainty is the response of the American motorist to the belief (not necessarily valid) that the days of skyrocketing motor fuel prices are over. It has been suggested that: 1) a period of level motor fuel prices will result in an increase in driving, with a correspondingly greater demand for fuel; and 2) motorists will not accept the small, fuel-efficient automobiles predicted for the next decade, but will instead turn back to larger, more comfortable and more powerful vehicles.

Residual Fuel Oil Demand.—Since residual fuel oil, as normally produced, is high in sulfur, environmental restrictions have reduced its use by utilities and industry. Its place has been taken by natural gas, distillate fuel oil, and coal. Thus, the demand for residual fuel oil is now declining. Current demands are for about 1.8 million bpd, resulting in increased needs for refinery fuel oil desulfurization and coking.²² The rate at which

¹⁷U.S. Department of Energy, Energy Information Administration, *Short-Term Energy Outlook*, Washington, D. C., February 1983, p. 5.

¹⁸*Oil and Gas Journal*, "Surviving the Shakeout: Refining and Marketing in the Eighties," Oct. 26, 1981.

¹⁹*Oil and Gas Journal*, "Petrochem Units Benefit From Integration, Flexibility," Apr. 11, 1983, p. 100.

*Arabian American Oil Co.—consortium of American and Saudi Arabian oil companies, formed in the 1920's to find and process crude oil in the Middle East.

²⁰Standard Oil Co. of California, 1981 *Annual Report*.

²¹U.S. Department of Energy, Energy Information Administration, *Short-Term Energy Outlook*, Washington, D. C., February 1983, p. 24.

²²*ibid.*, p. 26.

the demand for residual fuel oil decreases will be affected by natural gas usage policy and prices and by the rate at which major users of residual fuel oil can convert to coal in environmentally acceptable ways.

Motor Gasoline Upgrading.—Regardless of how the demand for motor gasoline changes, it is expected that unleaded gasoline—now over 50 percent of the refinery gasoline output—will comprise 100 percent of the market within 10 years.²³ It is also possible that gasoline octane numbers will continue to inch up in response to requirements for more efficient automobile engines, as well as to motorists' desires for better performance. The production of high-octane, unleaded

gasoline requires more complex and energy-intensive refinery processing. These complex facilities often require significant investments, while contributing nothing to the crude throughput of a refinery. In fact, the gasoline yield per barrel of crude oil may be lowered as a result,

Environmental Constraints.—Environmental restrictions designed to control gaseous emissions and the release of liquid pollutants have greatly affected refinery investments and operating costs, as well as the ability of refiners to install new process units or modify existing facilities. Although it seems unlikely that environmental regulations and emission controls affecting refineries will be stricter in the next few years, the present regulatory framework can make it very difficult to modify or replace existing facilities.

²³National Petroleum Council, op. cit., p. 52.

ENERGY AND TECHNOLOGY

Production Processes

To understand how refineries use energy and what the possibilities are for more efficient use of such energy, it is useful to review the principal processes of a modern refinery.²⁴

Atmospheric Distillation

Incoming crude oil is first treated to remove inorganic salts and then dehydrated. Under slight pressure it is then heated to a boil in a column where the various components of the crude oil are separated according to their boiling temperatures. Distillation, sometimes called "fractionation," is carried out continuously over a range of boiling temperatures, and at several points hydrocarbon streams within specific boiling ranges are withdrawn for further processing.

Vacuum Distillation

Some crude oil components are too heat-sensitive or have boiling points that are too high to be distilled at atmospheric pressure. In such cases the so-called "topped crude" (material from the

bottom of the atmospheric column) must be further distilled in a column operating under a vacuum. This operation lowers the boiling point of the material and thereby allows distillation of the heavier fractions without excessive thermal decomposition.

Fluid Catalytic Cracking

Through fluid catalytic cracking, crude petroleum whose lighter fractions were removed by atmospheric or vacuum distillation is entrained in a hot, moving catalyst and chemically converted to lighter materials. The catalyst is then separated and regenerated, while the reaction products are fractionated into their various components by distillation. This is one of the most widely used refinery conversion techniques.

Catalytic Reforming

Reforming is a catalytic process that takes low-octane materials and raises the octane number to approximately 100. Although several chemical reactions take place, the predominant reaction is the removal of hydrogen from naphthenes (hydrogen-saturated, ring-like compounds) and the conversion of naphthenes to aromatics (benzene-ring compounds). In addition to markedly in-

²⁴Process descriptions are adapted from Argonne National Laboratory publication *Energy and Material Flows in Petroleum Refining*, AN L/CNSV-10, February 1981. Available from National Technical Information Service, Springfield, Virginia.

creasing the octane number, the process produces hydrogen that can be used in other refinery operations.

Alkylation

In the alkylation process, isobutane, a low-molecular-weight gas is chemically added to the carbon-to-carbon double bonds that occur in certain hydrocarbons. The resulting product, now containing many isobutyl side groups, has a much higher octane number compared to the original straight-chained substance, and is therefore a better motor fuel. Branched-chain hydrocarbons, such as those with isobutyl side groups, are able to have their octane rating increased even further with lead additives, but with the increasing consumer need for unleaded gasolines, this type of alkylation will be less and less used.

Hydrocracking

Hydrocracking is a catalytic, high-pressure process that converts a wide range of hydrocarbons to lighter, cleaner, and more valuable products. By catalytically adding hydrogen under very high pressure, the process increases the ratio of hydrogen to carbon in the feed and produces low-boiling material. Hydrocracking is especially adapted to the processing of low-value stocks that are not suitable for catalytic cracking or reforming because of their high content of trace metals, nitrogen, or sulfur. Such feedstocks are used to produce gasoline, kerosene, middle-distillate fuels, and feedstocks for other refining and petrochemical processes.

Hydrotreating

A number of hydrotreating processes use the catalytic addition of hydrogen to remove sulfur compounds from naphthas and distillates (light and heavy gas oils). Removal of sulfur is essential for protecting the catalyst in subsequent processes (such as catalytic reforming) and for meeting product specifications on certain "mid-barrel" distillate fuels. Hydrotreating is the most widely used treating process in today's refineries. In addition to removing sulfur, it can eliminate other undesirable impurities (e.g., nitrogen and oxygen), decolorize and stabilize products, correct

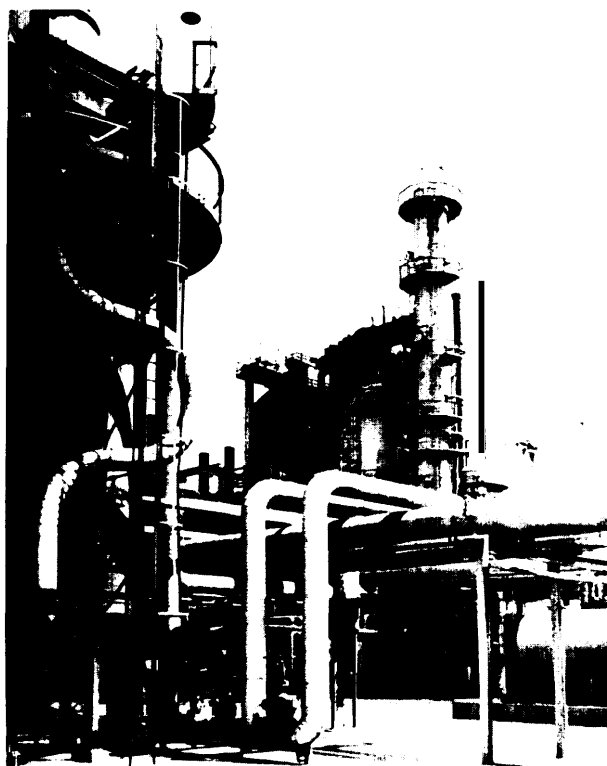

Photo credit: Phillips Petroleum Co. and American Petroleum Institute

A portion of Phillips Petroleum Co.'s refinery near Borger, Tex. In the background is one of two huge catalytic cracking units at this refinery. A large part of the refinery output is moved by four long-distance product pipelines, radiating in all directions from the refinery and serving markets as far away as Denver and Chicago

odor problems, and improve many other deficiencies. Fuel products so treated range from naphthas to heavy burner fuels.

Residuum Desulfurizing

With the increasing need to use the heavier, higher boiling components of crude oils (the "bottom of the barrel"), a number of processes are being offered for the desulfurization of residuum, the material remaining after atmospheric and vacuum column distillation. These processes operate at pressures and temperatures between low-severity hydrotreating and the much more severe hydrocracking previously described. Depending on the market, the desulfurized "resid" can be used as a blending component of low-sulfur fuel oils or as a feedstock to a coke producing unit (if a low-sulfur coke were to be made).

Coking

In the past, the residual bottoms from the crude unit have been blended with lighter oils and marketed as fuel oils of low-quality and often high sulfur content. These residues do, however, contain lighter fractions (naphthas and gas oils) that can be recovered if the residual oil is "coked" at high temperatures. It is becoming economically worthwhile to recover these remaining light ends for further processing. Petroleum coke is used principally as a fuel. Coke derived from untreated residues may have a high sulfur content and hence be of limited commercial value.

Kinds of Refineries

Refineries can be considered under the following three broad classifications:

Topping Refineries.—A topping refinery (fig. 20) is usually small, often having less than 15,000 bpd capacity (although some are much larger). It relies entirely on crude oil distillation to provide various product components, primarily liquefied petroleum gases, gasoline blending stocks, and distillate fuels (jet and diesel fuel and heating oils). Residuum would be sold as a heavy fuel oil or, if vacuum distillation were incor-

Figure 20.—Topping Refinery Model Configuration

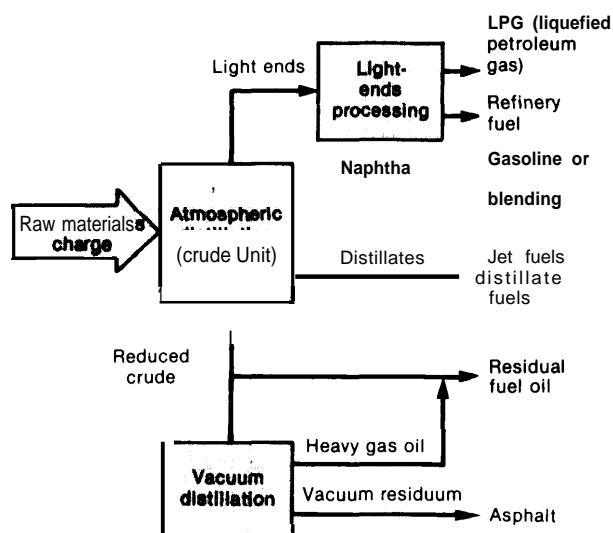

SOURCE: California Oil Scenario (Houston, Tex.: Bonner & Moore Associates, Mar 29, 1980)

porated, would be partly made into asphalt. Since a topping refinery, as described, has no cracking, hydrotreating, or reforming processes, its range of products is almost entirely dependent on the characteristics of the crude oil feedstock.

Hydroskimming Refineries.—Hydroskimming refineries (fig. 21) make extensive use of hydrogen treating processes for cleaning up naphthas and distillate streams. Thus, a refinery of this type is less dependent on the quality of the crude oil run, but it is still limited in its ability to produce high-octane, unleaded gasoline, and its product streams are heavily weighted toward fuel oils. Such a refinery would normally include catalytic reforming to increase its yield of high-octane finished gasoline.

Complex Refineries.—Most of the refining capacity (but not the number of refineries) falls into the category of complex refineries (fig. 22). A typical complex refinery uses most of the processes previously described. By virtue of its cracking

Figure 21.—Hydroskimming Refinery Model Configuration

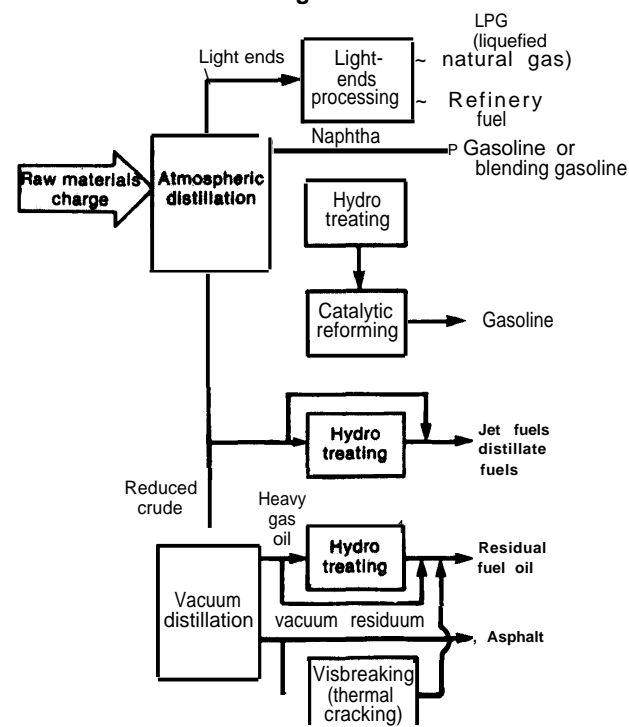

SOURCE: California Oil Scenario Bonner and Moore Associates, Mar 29, 1980

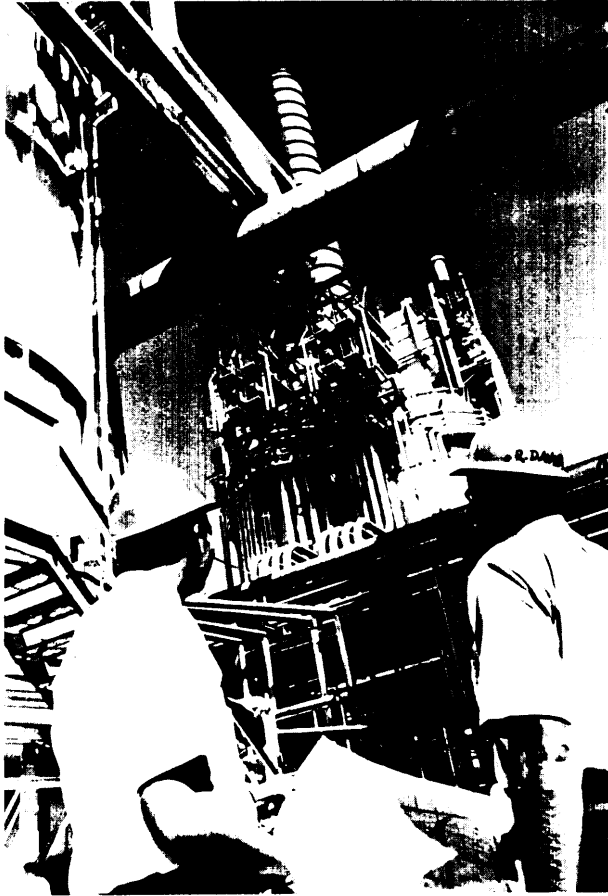

Photo credit Marathon Oil Co. and American Petroleum Institute

A portion of Marathon Oil Co.'s refinery near Robinson, Ill. In the background is the crude distillation unit which has a charging capacity of 110,000 barrels of crude oil per day

capacity, the refinery can convert high-boiling crude oil fractions (otherwise suitable only for heavy fuels) into lower boiling fractions suitable for gasoline and distillate fuels. By alkylation and other processes it can convert materials that are too light for gasoline into stocks that can be blended into gasoline. A typical complex refinery would thus be able to run a wider range of crude oils than would either a topping or a hydroskimming refinery. In addition, many—but not all—of the larger complex refineries will have distillation units designed to permit running crude oil of moderately high sulfur content (e. g., from the Alaskan North Slope).

Energy Use

The petroleum refinery has not traditionally been looked on as a major "profit center." Profits in the oil industry come instead from producing crude oil and from marketing the products or, in the large, integrated companies, from the total operation of getting crude oil out of the ground and products into the hands of the consumer. Refineries themselves were (and continue to be) expensive to build and operate. Refiners sought efficiency improvements primarily to obtain a greater output of more uniform products from existing equipment. They studied and improved processes and installed expensive instrumentation and control systems to eliminate as much as possible of the uncertain "human element." As a result, oil refining now has one of the highest capital costs per employee of any U.S. industry.

Although refinery managements and their technical staffs had other priorities, they have taken measures to use energy efficiently. In many refineries, periodic efforts were made to improve the steam balance and eliminate obviously wasteful plumes of exhaust steam. Where large volumes of surplus low-pressure steam were available, consideration was given to investing in a condensing turbine driving a continuously operating pump or blower. Many refineries at one time supplied their electrical energy needs by "topping" turbines exhausting to the refinery steam system, a highly efficient use of fuel energy. However, as refinery electrical loads increased and the cost of electrical energy available from local utilities continued to decrease, investments in additional refinery electrical generating capacity appeared less attractive when viewed by the standards applied to other investments in the oil industry. In time, purchased electrical energy came to supply most of the refinery load.

At a few locations, a refinery and a local utility were able to collaborate on a large powerplant in or adjacent to the refinery. Typically, the powerplant would obtain heavy fuel oil from the refinery. The utility, in turn, might supply steam to the refinery. However, many utilities were reluctant to lose their expensively treated boiler

Figure 22.—Complex Refinery Model Configuration

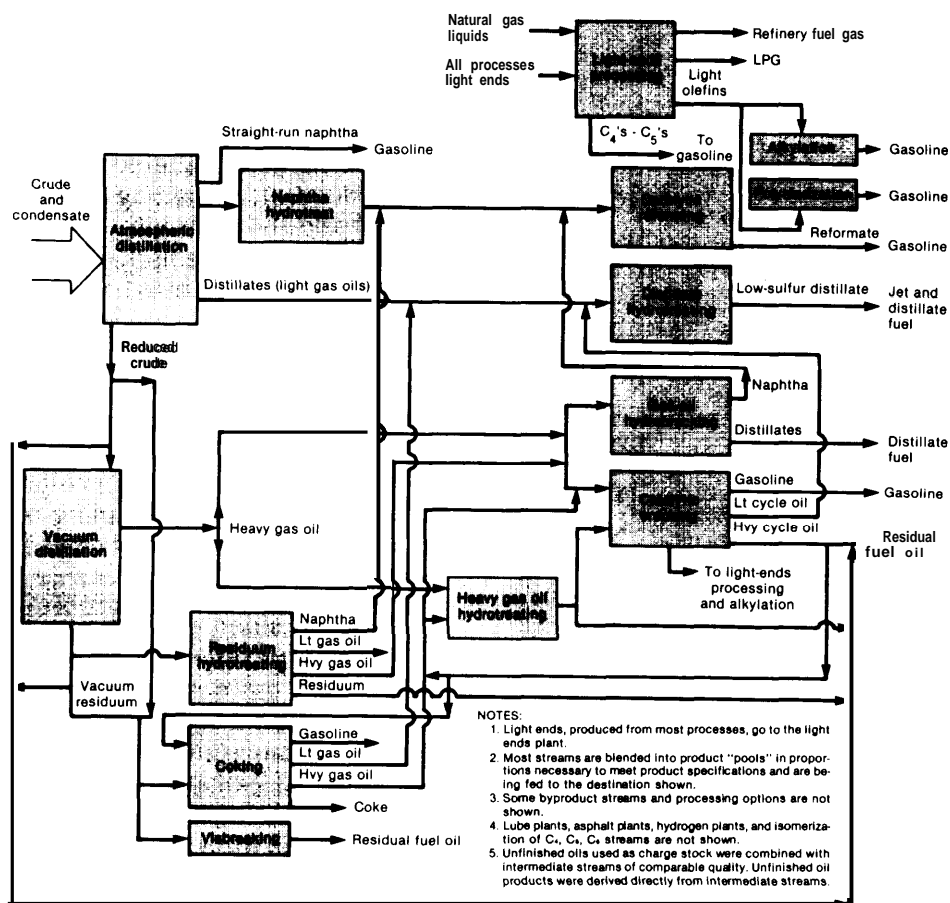

SOURCE: California Oil Scenario (Houston, Tex.: Bonnar & Moore Associates, Mar. 29, 1980).

feedwater in the form of steam that would not be returned (or would come back contaminated). These early attempts at cogeneration were not very successful because to be of interest to the utility, the electrical capacity of the refinery had to be much greater than the refinery's demand. Also, the utility's need for fuel and the refinery's for steam were normally not in thermal balance, and the overall economics of the joint venture were usually not attractive.

A rule of thumb used by some refiners is that it takes 1 barrel of oil-equivalent energy to process 10 barrels of crude oil. In other words, using an average heating value for crude oil, processing a barrel of crude through a typical refinery results in the use of about **580,000 Btu of energy**. **This is a good approximation of energy use. Small**

topping refineries use less energy per barrel, and complex refineries with a wide spectrum of finished products probably use more.

In typical refining processes, feed streams are normally heated, either to effect a physical separation (crude unit fractionation) or to provide energy for a heat-absorbing reaction (e. g., catalytic reforming). Although heat exchange is used to preheat feed streams to the highest economically feasible temperatures, additional heat is usually needed. Specifically, petroleum refining processes use energy in the form of fuel, steam, or electrical energy for the following functions:

- To heat crude units and other process feed streams.
- To make steam for mechanical-drive turbines to power major compressors and some large

pumps; for process heating, steam-stripping, and steam-jet vacuum ejectors.

- To heat reboilers (steam-fired or fuel-fired).
- To power most pumps and the fans in air coolers (usually with electric motors.)

Energy losses from petroleum refining operations are primarily the result of the following:

- Heat rejected by (lost to) air- and water-cooled heat exchangers used to cool recycle and product streams. (This equipment is estimated to account for up to 50 percent of refinery heat losses.)
- Unrecovered heat in flue gases from furnaces and steam boilers (perhaps 25 percent of refinery energy losses).
- Convection and radiation losses from hot equipment and piping.
- Steam system losses.

Although most refineries maintain summary records of energy use by their process plants and

of energy purchased from utilities or sold offsite to other energy users, the only complete public, nonproprietary analysis of a "refinery energy profile" is the study of Gulf Oil Co.'s Alliance refinery carried out by Gulf Research & Development Co. under contract to the Department of Energy's (DOE's) Office of Industrial Programs.²⁵ Alliance is a typical complex refinery incorporating all the principal refining processes described earlier, with the exception of hydrocracking. Figure 23, reproduced from the Gulf Research report, illustrates the flow of energy into the total refinery, as well as the form and amount of energy losses from the system.

Energy Conservation

For this report, the basis for reviewing the energy conservation record of the petroleum refin-

^aGulf Research & Development Co., *Refinery Energy profile—Final Report*, prepared for DOE, report No. ORO-5262-5, January 1979,

Figure 23.—Alliance Refinery Energy Profile
(M Btu/bbl of oil charge to refinery and percent)^a

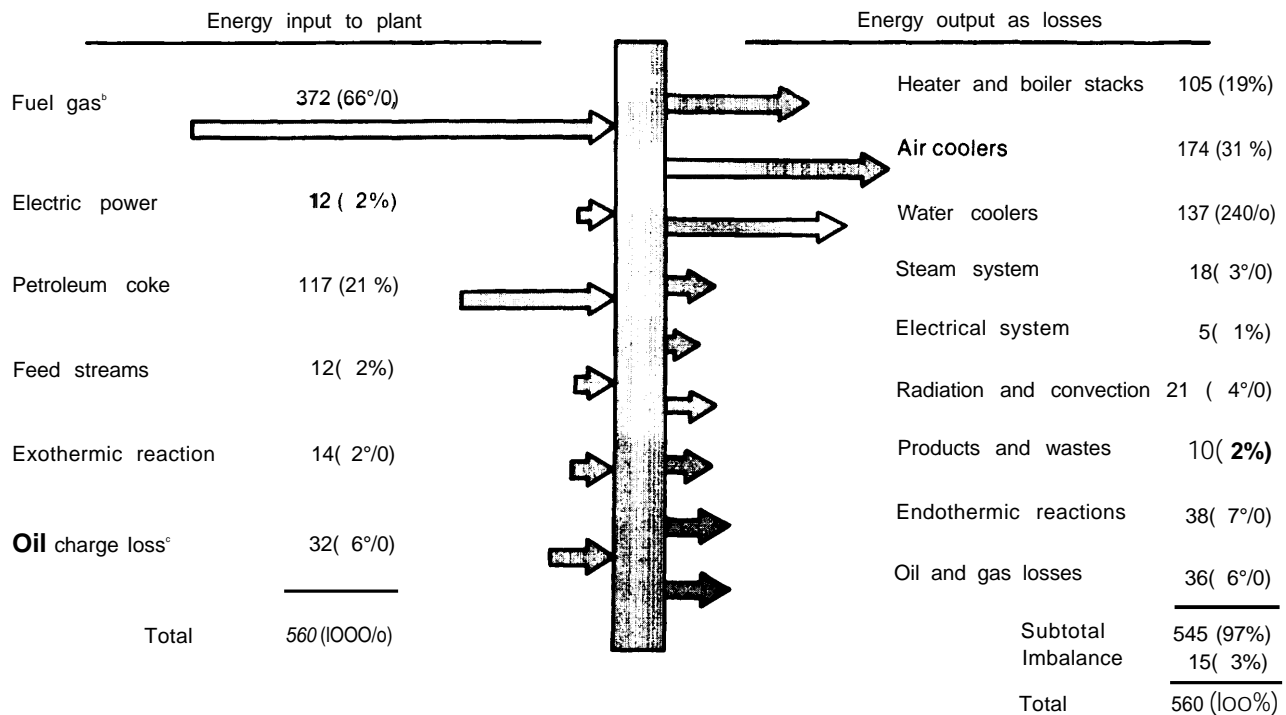

^aBased on period 9126177. 1016177 at 214,636 bpd Oil charge to refinery.

^bIncludes 2713 (487.) of refining gas and 102 (18%) of natural gas.

^cEnergy value of combustible portion of stock losses.

SOURCE: Department of Energy, *Refinery Energy Profile-Final Report*, prepared for DOE by Gulf Research & Development Co., Report No. ORO-5262-5, January 1979.

ing industry is the energy efficiency report made by the American Petroleum Institute (API) to DOE's Office of industrial Programs. Table 25 presents the petroleum refining industry's report to DOE on energy consumption for the year 1981.

As part of DOE's energy efficiency program, the petroleum industry adopted a voluntary goal of improving efficiency by 20 percent by 1980. A measure of industry progress toward this goal is shown in figure 24. Electricity and petroleum use remained approximately constant over the time period. However, natural gas use is now less than two-thirds of what it was in 1972. Production decreased by less than 1/2 percent over the same time period.

Potential for Energy Saving

It is to be expected that refinery managements and their technical staffs will continue to look for energy-saving opportunities and to implement those that appear to be economically justified. However, in evaluating progress the refining industry has made in energy conservation, as well as the potential for further savings, it is essential to keep several considerations in mind.

First, competition for capital funds in the petroleum industry is intense and likely to remain so.

Table 25.—Comparison of 1972 and 1981 Energy Consumption in Petroleum Refining Industry

| Energy type | 1972 consumption | 1981 consumption |
|----------------------------------|------------------|------------------|
| 1. Electricity | 200,525 | 250,193 |
| 2. Natural gas | 1,034,006 | 686,277 |
| 3. Propane | 9,850 | 6,979 |
| 4. LPG | 28,438 | 24,852 |
| 5. Bituminous coal | 4,850 | 4,823 |
| 6. Anthracite coal | 38 | 0 |
| 7. Coke | 0 | 0 |
| 8. Gasoline | 107 | 112 |
| 9. Distillate fuel oil | 22,183 | 8,425 |
| 10. Residual fuel oil | 257,606 | 177,028 |
| 11. Petroleum coke | 441,512 | 427,569 |
| 12. Purchased steam | 37,128 | 27,629 |
| 13. Refinery gas | 1,030,162 | 1,162,453 |
| 14. Other liquids | 6,692 | 2,487 |
| 15. Other (specify) | | |
| 16. Total energy consumption | 3,073,098 | 2,778,827 |

SOURCE: American Petroleum Institute, 1981 Report to the U.S. Department of Energy, "Energy Efficiency Improvement and Recovered Material Utilization Report."

Figure 24.—Comparison of Petroleum Refining Industry Energy Use and Production Output 1972 and 1981

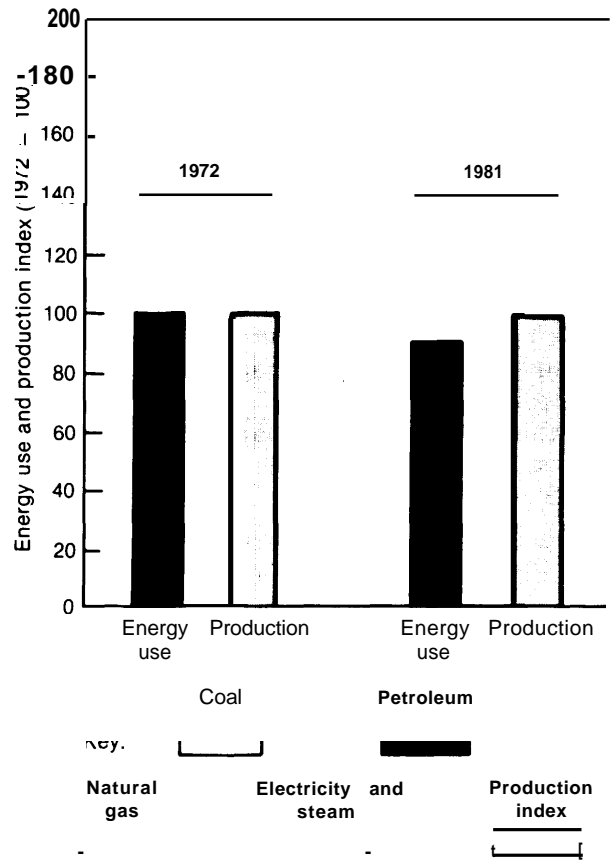

SOURCE American Petroleum Institute and Federal Reserve Board

Thus, corporate management may see currently underused refineries as less desirable for investment than are the exploration and production activities that are rightly considered to be essential for the future well-being of the industry.

Second, many of the easy and obvious opportunities for energy savings have been taken. Additional opportunities, although certainly present, will be more difficult to identify and justify economically. In part, these energy savings will be difficult to make because environmental regulations have affected the industry's energy use in terms of the need for energy-consuming pollution abatement equipment and also in terms of the mandate to produce unleaded gasoline.

Technologies for Increased Energy Efficiency

Numerous energy conservation opportunities have been identified in the petroleum refining industry.²⁶ The most productive energy-conserving measures appear to be in the areas of improved combustion, the recovery of low-grade heat, and the use of process modifications.

However, there are several barriers to improving the efficiency of energy use in refineries. First, there are operational limits. Energy efficiency measures to achieve energy savings cannot often be put into effect just by a plant's operating organization when it is primarily concerned with running the equipment, maintaining safe conditions, and producing the desired amounts of specification products. An effective energy conservation program requires a sustained technical effort having the consistent support of the company's management.

Second, there are thermodynamic limits to the amount by which heat input into the processing "system" can be reduced. Many of the chemical reactions in refining processes require heat (i. e., they are endothermic). Other operations, such as fractionation, require that fluid streams be heated to high temperatures. It is not possible to obtain all this heat by exchange with other streams. Even more fundamentally, the great amounts of heat present in refinery lines, vessels, and tanks at low or moderate temperatures cannot be upgraded to higher temperatures by any techniques now available. Fired furnaces must usually provide such heat.

Finally, there are economic limits to the investments that can be justified to achieve specific energy savings. The amount of energy saved does

not justify the capital required. Some of these limits will be apparent in the following discussion.

Proven Technologies for Energy Conservation

Considering only proven technologies, the most significant opportunities for energy savings in refineries are likely to be found in the following operations and systems.

Air and Water Cooling of Process Streams

As indicated previously in figure 23, the final cooling of process streams in air- and water-cooled heat exchangers can represent the greatest single loss of heat in the refinery. Where feasible, heated streams can first be used to heat other process streams and thus minimize the amount of heat rejected to air or water. Cold streams suitable for this exchange must be available. The Gulf Research study showed that the total energy input requirements of the refinery could be reduced by about 18.7 percent if all such streams could be brought down to a temperature of 2000 F by process heat exchange before being cooled further. Such an extreme reduction is unlikely to be feasible, but the Gulf study showed that reductions to 250° or 300° F would reduce energy requirements by 8.6 and 3.7 percent, respectively. (Recovery of low-grade heat as mechanical energy is discussed under "New Concepts" in the next section.)

Process Heaters and Steam Boilers

These direct-fired units offer many opportunities for energy savings. With fired heaters, some of the options are: 1) reducing excess air and improving combustion by using stack gas analyzers and combustion control instrumentation, 2) reducing stack gas temperatures by using air preheater to heat incoming combustion air, and 3) installing convection sections at the heater outlets to heat incoming feed or to generate steam. (A constraint on the last two options is the need to keep stack gas temperatures above the sulfur content "dew point," below which serious corrosion of carbon steels can be anticipated.) Steam boilers, although many commonly incorporate such heat-conserving devices as air pre-

²⁶ *The Potential for Energy Conservation in Nine Selected Industries: The Data Base, Vol. 2, Petroleum Refining*, Gordian Associates, Inc., for the Federal Energy Administration, NTIS order No. PB-243-613, June 1974; *Energy Efficiency Improvement Targets, Vol. 1, Petroleum and Coal Products*, Gordian Associates, Inc., for the Federal Energy Administration, contract No. FEA/D-77/244, June 25, 1976

heaters and “economizers,” can also often benefit by improved combustion controls and perhaps by boiler blowdown heat recovery.

Steam System Improvements

In most refineries, steam is generated and then distributed at moderately high pressure (often 600 psi), as well as at medium or low pressures, such as 150 and 50 psi. The steam is used for heating and for mechanical drives (usually turbines) at many locations in the refinery. Ideally, the steam generated and distributed at these pressure levels is used at such levels, and is reduced or “let down” to a lower level only while doing useful work. At the lowest pressure level, all steam is ideally used for heating (or perhaps driving a condensing steam turbine) so that no steam is wasted by being vented to the atmosphere. Such a system represents the ideal goal of being “in balance.”

Inevitably, though, process plants are modified, and their uses of steam change. Steam systems get out of balance, and frequently no juggling of steam turbine and motor drivers can prevent wasteful let-downs of high-pressure steam or venting to the atmosphere of excess low-pressure steam. When steam systems become acutely imbalance, many refineries achieve significant savings by changing major drivers; installing large, low-pressure, condensing turbines; and using other means to minimize loss in the system. Since it is almost never economical to generate steam for a turbine driver if its exhaust steam will be wasted, replacement of such turbines by motors often represents an attractive investment.

Improved Process Heat Exchange

A refinery will contain many heat exchangers for transferring heat from one process to another. A great number of heat exchanger arrangements are usually possible, and the optimization of heat exchange—especially in the crude preheat train—is an important aspect of plant design. In the design of many U.S. refineries, low fuel prices (and hence low energy costs) resulted in a minimum amount of heat exchange being installed originally. Although a major revamp of heat exchange systems can be quite expensive, and sometimes impossible because of space limita-

tions, such an investment will often show a very good return.

Improved Instrumentation and Controls

Most refiners have steadily improved their instrumentation and control systems, even to the extent of using closed-loop computer controls. The economic benefits from such systems are primarily in improved performance of the process units, but consistently higher outputs and closer product specification tolerances can also result in significant energy savings per barrel of finished product.

Improved Insulation

As with heat exchange systems, insulation standards in many refineries were developed during the earlier era of cheap energy. Substantial heat losses from lines, vessels, and other equipment were anticipated. Many engineering design practice standards called for no insulation of surfaces at temperatures below 200° F unless a surface represented a hazard to operating and maintenance personnel who could inadvertently touch it from grade or operating platforms. In such cases, the hot surface was often insulated only as far as a person could reach. With increased energy costs, insulation of surfaces at much lower temperatures can now be justified. This justification is especially apparent for large, bare storage tanks operating at temperatures well above that of their surrounding environments.

Energy Recovery From Process Streams

Many high-pressure, gaseous, and liquid process streams are “throttled” by control valves, with significant energy loss. In some applications, hydraulic turbines and power recovery turbines (turboexpanders) can be used to extract considerable energy from such streams.

Pump Efficiency Improvement

Since refinery motors (and most mechanical-drive steam turbines) operate at constant speed, control of output from the pumps they drive must be achieved by throttling through a control valve. If the characteristic curve of the pump essentially matches that of the piping system, this throt-

ting dissipates only moderate amounts of energy and can usually be ignored. Unfortunately, mismatches of pump and system are all too common, and often intentional. Design engineers have been encouraged to specify pump impellers of greater diameter (which often need larger motors) than the hydraulic design actually requires. Thus, the engineer is protected against charges of having “underdesigned,” and the operator is assured of immediately available extra capacity in case he ever wishes to operate the plant above the original design limits. As a result, during its entire lifetime the pump wastes energy by discharging against a partially closed control valve, while the unnecessarily large motor driver, operating below its rated output, wastes even more energy because it is well below its point of maximum efficiency. Although the principal savings in this area can be achieved by proper selection of pumps and drivers initially, simply changing pump impellers can often achieve significant savings in an operating plant.

Fractionation Efficiency Improvements

The operating characteristics of a fractionating column are largely established in initial plant designs. Once the column has been installed, relatively little modification is feasible, and specific opportunities for energy savings are limited. However, many columns are operated at considerably higher reflux rates than necessary for proper fractionation. Reducing these reflux rates to the minimum required for proper functioning of the column can result in significant savings.

Refinery Loss Control

Many potential types of refinery losses include losses from flares, relief valve leaks, tank filling, evaporation from tanks and from oil-water separators, other leaks of all types, tank cleaning and vessel draining, and spillages from all forms of loading operations.

Housekeeping Measures

Potential savings by vigilance in policing and correcting such energy wasters as faulty steam traps, damaged insulation, careless steam depressurizing and venting, and the like. The possible

energy-saving measures discussed to this point involve well-understood technologies and operating and maintenance practices. The challenge to refineries comes from the need to identify such opportunities in specific plants, evaluate them to determine what corrective measures can be justified, and then proceed to take the necessary action.

New Concepts in Refinery Energy Use

Beyond the existing technologies discussed above there appear to be some significant, long-term opportunities for improving in energy efficiency by the use of certain new—or at least unproven—technologies. Refineries may be able to use other sources of energy, and otherwise wasted heat, to reduce the combustion of gaseous and liquid fuels. OTA considers that fuel substitution (such as the use of coal in refineries) is an important goal, even though the calculated efficiency of fuel energy use may not be improved or may even be lowered as a result of such a change in fuel.

The majority of refinery process heaters now burn only gaseous and liquid fuels derived from petroleum. In some heaters, tube configurations and the need for close control of process reactions permit only gas to be burned. Since it is perhaps not entirely clear why coal-burning refinery process heaters have not been developed, it may be useful to summarize the principal demands made on refinery process heaters:

1. In many heaters, the fluids undergo process reactions in the tubes, often at high pressure and temperature. Careful monitoring and precise control of such reactions are essential, since the process fluid will decompose if heated above the intended temperature.
2. Precise firing control is necessary for rapid, even instantaneous, control response necessary because of the need to shut down firing immediately if the instrumentation or operators detect tube failures, dangerously reduced flow rates in any tubes, or a power failure.
3. In addition to the required, precise control of temperature of the process streams being heated, measurement and control of tube

wall temperature in many furnaces is necessary to prevent overheating and rupture of the tube, with the resulting prospect of a serious fire.

Coal as a Refinery Fuel

Coal-fired furnaces are perceived by refiners as unable to meet any of the above requirements because they have considerable "thermal mass" and respond relatively slowly to control changes. Also, coal firing results in molten ash deposition on tubes at some temperatures. Lower heat-release rates for coal burning require larger (and hence more expensive) furnaces. Large volumes of ash must be dealt with and—as always with conventional coal burning—the stack gases must be cleaned of particulate and perhaps even scrubbed to remove sulfur acid compounds. In view of the historically small differential between the costs of coal energy and those of petroleum, it is understandable that little pressure has existed for the development of coal-fired refinery process heaters. Now, however, with increasing energy costs and potential restrictions on the use of petroleum-derived fuels, renewed emphasis is being placed on coal as a potential refinery fuel. Some of these developments are discussed in the following paragraphs.

CONVENTIONAL FIRING

Several attempts have been made to design process heaters in which coal would be fired directly. Furnace "geometry" would of course be different; provisions for ash collection and removal would be provided; and other changes would be made to use the electric utilities' experience with burning coal. Pulverized coal (rather than stoker firing) would be necessary to permit faster response to combustion controls. Although some progress reports have appeared in the technical press, the refining industry's apparent conclusion is that no coal-fired heater designs are yet available to meet the exacting demands of process heater service.

FLUIDIZED-BED COMBUSTION

Fluidized-bed combustion is a process by which a fuel is burned in a bed of small particles that are suspended, or "fluidized," in a stream

of air blown upward from below the bed. Almost any type of properly dispersed fuel can be burned in a fluidized bed, but most of the technology of interest relates to the combustion of coal in a "clean" manner that eliminates the need for stack gas scrubbing devices to remove sulfur oxides. This result can be achieved by feeding crushed limestone or dolomite into the fluidized bed along with the coal. The sulfur in the coal combines with the calcium in the crushed rock to form calcium sulfate. Sometimes identified as "spent sorbent," this material is removed with the ash, and the combined solid waste is disposed of as landfill or used in some other manner.

The concept of a fluidized bed is not new. Since the 1940's, various forms of catalytic crackers, using fluidized beds, have evolved. The fluid catalytic cracking process is the result of this development. The petroleum refining industry has been following the development of fluidized-bed combustion with great interest. Although it was originally thought to be just a clean method of burning coal for refinery steam generation, fluidized-bed combustion could ultimately develop into a technology for providing a large part of the total heat required by a refinery. As an illustration, figure 25 shows, in elementary form, a conceptual comparison between steam boilers and process heaters using atmospheric, fluidized-bed combustion (AFBC) techniques. In this concept (diagram C), the process fluid to be heated would be immersed in the fluidized bed.

Since coal-burning equipment of any type requires large areas for coal storage and handling, as well as for ash disposal, it would not be feasible to replace individual process heaters throughout a refinery with coal-burning, fluidized-bed units. Instead, it is possible to visualize large fluidized-bed process heaters made up of several cells. Steam would be generated from coils in some parts of the bed, and process heat could be generated in coils in other parts of the bed. Because of the distances involved and the characteristics of process fluids, it seems unlikely that many process steams would be heated directly by means of coils in fluidized beds. Instead, heat might be transferred to the process areas by hot-oil systems and heat exchangers, and perhaps also by high-temperature, pressurized water sys-

Figure 25.— Diagram of Atmospheric Fluidized-Bed Combustion (AFBC) Boiler/Combustor Arrangements

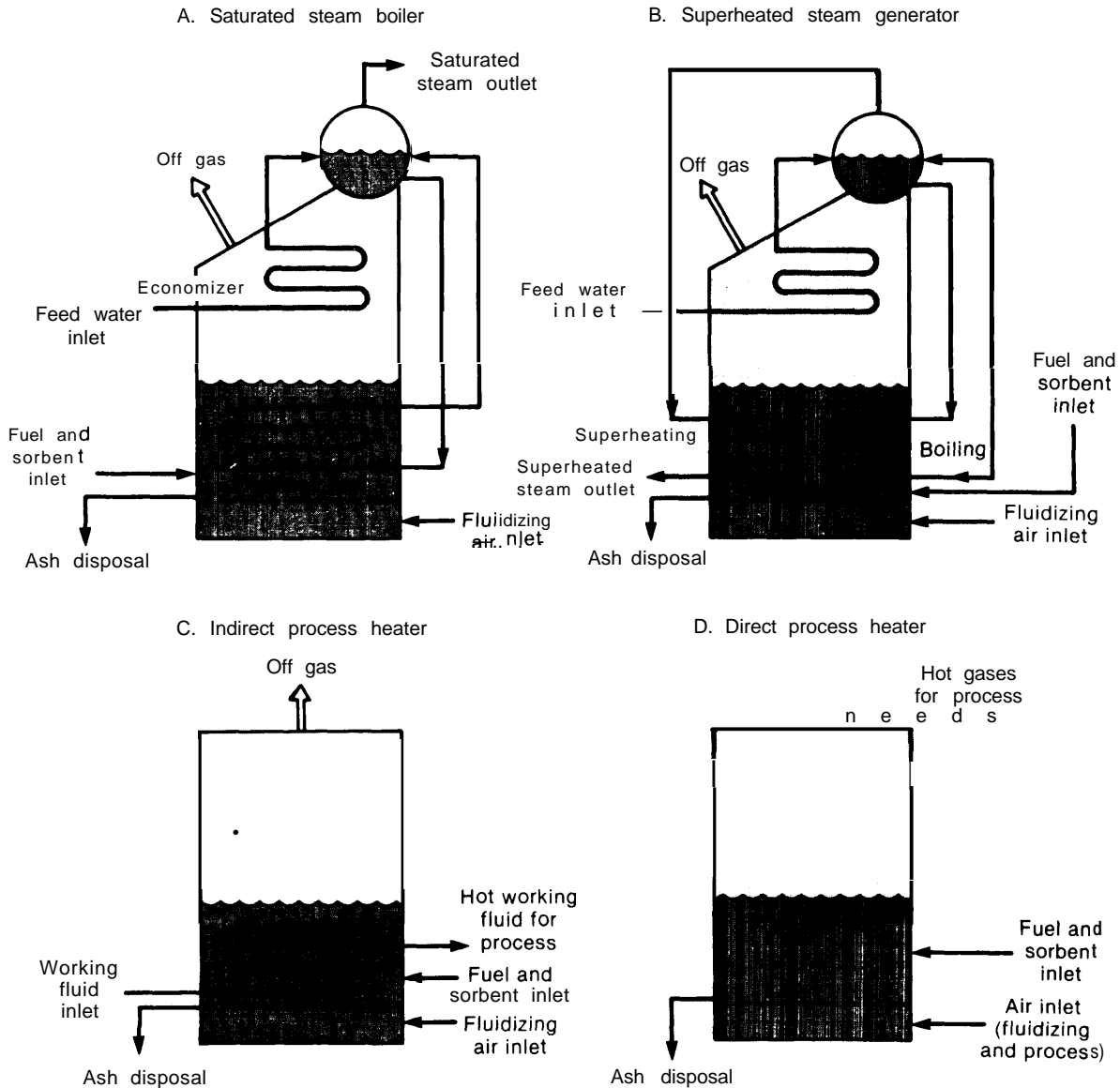

SOURCE U S Department of Energy 1977 Annual Report

terns. Since some process streams must be heated to temperatures higher than a hot-oil system could feasibly deliver, some process heaters would still be required.

In view of the foregoing, it seems necessary to conclude that fluidized-bed combustion of coal, although perhaps an eventual means of reducing the combustion of petroleum-derived fuels in refineries, will not be a significant process

energy option in the immediate future. It very likely will, however, find increasing application for steam generation in refineries.

COAL GASIFICATION

It has been suggested that refineries might install coal gasification units to obtain energy from coal. Coal gasification could most logically produce a medium-Btu industrial "syngas" com-

posed primarily of hydrogen and carbon monoxide. However, it seems unlikely that such an installation would now be attractive to refiners. The gasifiers being offered are in various stages of development, and none can be considered reliable. Likewise, the relatively low conversion efficiency of the process, the problems of handling coal and ash, the need to build and operate an adjacent oxygen plant, and the complications of converting refining furnaces to use a fuel of much lower Btu than now used all argue against considering coal gasification a reasonable option. If done at all, it seems most likely that coal gasification will be undertaken by a major utility serving refineries along with its many other industrial customers.

Thermal Recovery of Low-Level Heat

As might be expected from the magnitude of losses to air- and water-cooled heat exchangers, refinery management and its technical staff see thermal recovery of low-level heat as a prime opportunity to save energy. They are also aware that opportunities for recovering significant amounts of this wasted heat are unlikely to be found in existing operating plants, but must await instead the design of new facilities where heat balances can be developed with consideration for the true values of heat at all temperatures and pressure levels.

One major refining company is designing a new lubricating-oil manufacturing plant to take advantage of low-level heat recovery. In this plant, the process streams being "run down" for final cooling first generate 45-lb steam and then provide heat to a pressurized, "tempered" water system operating at about 2850 F. The tempered water is used for process reboilers and also as the heat

source for the aqua-ammonia absorption refrigeration system, a key part of the plant. Finally, the process streams are cooled in the conventional manner. Although these streams are still at temperatures of approximately 300° F when finally cooled, considerable energy that would otherwise be wasted is recovered.

Most of the many opportunities for using low-level heat from rundown streams will appear in the design of new facilities whose energy requirements are not circumscribed by existing systems.

Mechanical Recovery of Low-Level Heat

Low-level waste heat might be used to vaporize a fluid, use the vapor to operate a mechanical-drive turbine, and then condense the vapor for recycling to the heat source. Although the concept is straightforward, its practical application is not. Organic fluids must be used instead of water because of the size of the required equipment and the complexity of operating under a vacuum. * Selection of a working fluid involves considerations of toxicity, environmental acceptability, cost, and the thermodynamic properties needed for the cycle. Although the various fluorocarbons are leading contenders, increasing restrictions may make their use inappropriate. Other typical refrigerants have been considered, and one, toluene, is used in one experimental application reported in the literature. Finally, **in addition to other limitations of this method, the low level of heat involved limits energy** recovery to perhaps 10 percent, making this form of energy conservation generally unattractive economically.

*The term "organic rankine cycle" is used to refer to this low-level heat recovery technology.

INVESTMENT CHOICES FOR THE REFINING INDUSTRY

In this section OTA examines certain broader aspects of the petroleum industry, including: 1) competition for capital investment dollars within the industry as it is now structured, and 2) possible investment opportunities in largely nonoil operations. OTA then relates the alter-

native investments discussed to those for energy-saving options in refineries.

Capital Expenditures in the Oil Industry

In considering investment opportunities and incentives for energy-saving measures in refineries,

it is essential to keep in mind the magnitude of other demands for capital in the entire industry. For example, the *Oil & Gas Journal* summarizes the 1982 budget for the U.S. oil industry as:

| | |
|-----------------------------------|------------------------|
| Exploration and production | \$.66.8 billion |
| Refining | 6.4 billion |
| Other | 22.1 billion |
| Total 1982 budget | \$.95.3 billion |

The Standard Oil Co. of California capital expenditure record (shown below) for 4 years is consistent with the *Journal's* report and is believed to be representative of similar expenditures by other major U.S. oil companies.

| Capital and Exploratory Expenditures (millions of dollars) | | | | |
|------------------------------------------------------------|-----------------|----------------|----------------|----------------|
| | 1977 | 1978 | 1979 | 1980 |
| Producing and exploration | \$. 891 | \$1,163 | \$1,603 | \$2,230 |
| Manufacturing: Chemicals | 60 | 26 | 57 | 91 |
| Refining | 168 | 149 | 187 | 328 |
| M a r k e t i n g | 76 | 92 | 102 | 272 |
| Transportation | 84 | 50 | 96 | 134 |
| O t h e r | 150 | 212 | 213 | 544 |
| Total expenditures | \$.1,429 | \$1,692 | \$2,258 | \$3,599 |

A very significant aspect of the foregoing figures is the magnitude of the financial resources needed to discover and produce crude oil and natural gas. These expenditures have increased rapidly in recent years, partly because of the anticipated (and then actual) decontrol of oil prices and because of the urgent need seen by the industry to reduce its dependence on foreign sources of crude oil. In addition, even though geophysical techniques are constantly improving, exploration operations produce many more "dry holes" than wells promising commercial production. As the potentially hydrocarbon-bearing geologic structures now being explored are at increasingly greater depths, the exploratory wells and those drilled for production of commercial discoveries are becoming increasingly expensive.

Another drain on the capital resources of the industry is the previously mentioned restructuring of processing systems to permit running heavy, high-sulfur crude oil and producing the increasing share of unleaded gasoline that must be provided for the motor fuels market.

Other Investment Opportunities

Corporate planners in the oil industry work in an atmosphere of great uncertainty. They know

that supplies of crude oil and natural gas will become increasingly scarce, but they do not know whether a serious availability "crisis" will occur within a decade, a generation, or at some time in the next century. More immediately, they cannot assess political conditions in the troubled areas of the oil-producing world accurately enough to forecast either worldwide price trends or the amounts of imported crude oil the Western world can safely count on. They can be certain, however, that their past world of steadily increasing crude runs and product sales has come to an end; they must now do the best they can to plan for an uncertain future. Two options—not mutually exclusive—seem open to the industry:

- Concentrate on employing the resources and special skills they now have available, including searching out long-term investment opportunities in areas of technology that can be developed without major shifts in corporate structure, personnel, or markets.
- Use their great financial resources and presumed managerial and technical expertise to enter any field of endeavor that promises financial rewards, regardless of its relation to existing operations.

In considering options of the second type, oil industry corporate management may find itself confronted with what might be termed an "identity crisis." As repeated public opinion polls demonstrate, the industry is now held in low esteem by much of the U.S. public. In spite of clear factual evidence to the contrary, a large segment of the public seems to believe that the much publicized oil shortages and the gasoline lines of the recent past—and for many, perhaps, even high gasoline prices—have been contrived by the major oil companies for their own financial benefit. Although legislative proposals for break up or nationalization of the industry appear to have subsided, such proposals are very much **in the background and would probably be reintroduced if their sponsors felt the political climate were right.**

The public can likewise be expected to recall that much of the industry vigorously campaigned for decontrol of oil prices, giving as a principal justification the need for more revenue to increase oil and gas exploration in the United

States. Now that oil price decontrol has been achieved, public opinion and editorial comment could be most unfavorable to announcements by major oil companies of large investments in activities unrelated to the oil business or to takeover attempts within the industry by companies already perceived to be "big enough."

Given this background, corporate management might seek several types of investments to guide their companies during the uncertain transition period.

Energy Investments

The most obvious area of oil industry expansion involves investments in other forms of energy. Although not all investment decisions use oil industry expertise directly, most do follow the sequence, "research-development-marketing," to which the industry is accustomed. Examples would include the following:

Synfuels: Liquefaction of Coal.—Liquefaction of coal is perceived by many industry analysts to be one of the best long-term opportunities for major refiners. In direct liquefaction processes, liquids are obtained directly by hydrogenation of coal. Liquefaction processes are being developed in many of the major oil industry process laboratories, and several processes are felt to be approaching commercial development—examples are SRC-11, Exxon Donor Solvent, and H-Oil. Unfortunately, all these processes still appear to be plagued by mechanical problems as well as by process uncertainties. Moreover, recent declines in crude oil prices, together with the great reduction in Federal subsidization of demonstration energy projects, make it unlikely that direct liquefaction plants of commercial size will be built in the near future. Nevertheless, these processes represent a long-term source of liquid fuels that could supplement and perhaps ultimately supplant crude oil in the manufacture of liquid fuels and a wide range of other products. It is to be expected that the industry will continue to work on their development.

Indirect processes of coal liquefaction are those in which coal is first gasified to produce a medium-Btu syngas. This gas can be converted to liquid fuels or to chemical feedstocks, as done in

the South African Government's large "Sasol" plants. Alternatively, the syngas can be converted to methanol and then to gasoline, using Mobil's proprietary process. Although the indirect liquefaction technologies are considerably further along in development than are the direct processes, they seem to be less attractive to the oil industry. Their conversion efficiency is significantly lower, and they do not produce the wide range of products required by oil industry markets. Oil industry R&D appears to be concentrated on direct liquefaction processes, but considerable effort is also being devoted to the indirect approaches.

Geothermal Energy production.—Some geothermal energy resources (steam and hot water) can be identified by surface geologic conditions, others by exploratory drilling for oil and gas. Typically, an oil company exploiting a geothermal resource will top the steam or hot water and then sell it to a utility for power generation. Cooled water may be returned for injection into the formation. In spite of many optimistic assessments, use of geothermal energy resources presents many technological and environmental problems that can be expected to slow development. Nevertheless, geothermal energy resources in the United States are of very great magnitude. It is expected that oil industry participation in their use will continue.

Petrochemicals.—Most U.S. manufacture of petrochemicals (including basic feedstocks) is not especially profitable at present. Although it is a basic activity of the refining industry, petrochemical manufacture would not appear to be an attractive investment area until the potential problems of foreign competition are resolved and the U.S. market improves.

Alternative Energy Sources.—Many oil industry laboratories conduct intensive research programs in such fields as fuel cells, solar photovoltaics, and other forms of solar energy utilization. Most of these activities are considered to be very long range. It is hoped that some will result in new and economical sources of energy, but none is believed to be at a point where a major capital investment in the technology would be considered.

Oil Shale Mining and Processing.—Many of the major oil companies are undertaking oil shale projects, and others have been preparing to do so. Some acquired their own oil shale properties many years ago. Others operate under Federal leases. The hydrocarbon reserves in Colorado and other oil shale deposits are of very great size, and much informed opinion in the oil industry holds that oil from shale will be developed and on the market long before synfuels from coal can be produced. Nevertheless, billion-dollar investments will be required for shale production and retorting, and few companies appear to be willing (or able) to proceed with such developments without Federal product purchase contracts or loan guarantees. As with many other energy proposals, softening prices of crude oil are dampening the recent enthusiasm for shale oil, and several cutbacks and postponements of these developments have already been announced. Although ultimate use of these shale oil resources

seems certain, the firms making investments now are doing so because of the long-range potential, and not in expectation of immediate profits.

Nonoil-Related Investments

Although many nonoil-related investments are initially profitable—and others may prove so after initial difficulties—several have already caused unfavorable comment in the financial press. Among the best known examples of investments that apparently have not been profitable are Mobil's acquisition of Marcor (including Montgomery Ward), Exxon's Office Systems Co., and Exxon's acquisition of Reliance Electric. It would appear that such investments are appropriate only when oil industry management is confident that no reasonably equivalent opportunities can be found in its own industry—including the often overlooked possibilities of investments to achieve more efficient refinery operations.

IMPACTS OF POLICY OPTIONS ON THE PETROLEUM REFINING INDUSTRY

Having examined the energy use characteristics of the petroleum refining industry, including the specific unit operations where energy is used and the technological opportunities that can improve the efficiency of energy use, the rest of this chapter will be devoted to an examination of the effect of a series of policy options as they would influence energy use.

This analysis is based on a trio of analytical methodologies. In each policy option case, OTA has projected fuel use between 1980 and 2000 using the Industrial Sector Technology Use Model (ISTUM). Second, OTA has assembled a list of eight typical projects in which a petroleum refinery management could invest its capital funds. The projects are ranked according to their internal rate of return (IRR) under both the reference case and the policy option. Any changes in the ranking are then examined and discussed. Finally, the observations and analyses of OTA's consultants, advisory panelists, and workshop participants are noted.

The projects used to illustrate the IRR calculations are described in table 26. Four of the projects are specifically oriented toward the petroleum refining industry. The remaining four are generic—i. e., they are applicable throughout the industrial sector.

A graphical illustration of the impact of each policy option on energy use in the industry is presented in figure 26. The analysis begins with a discussion of the reference case.

The Reference Case

The reference case is predicated on the economic and legislative environment that exists today. It includes the following several general trends that can be identified at present and which should continue over the next two decades:

- **A general decline in the total amount of refined product produced between 1980 and 2000.**

Table 26.—Petroleum Refining Industry Projects To Be Analyzed for Internal Rate of Return (IRR) Values

- | | |
|----------------------------------------------------------------------------------------------------------------------------------------------------------------------------------------------------------------------------------------------------------------------------------------------------------------------------------------------------------------------------------------------------------------------------------------------------------------------------------------------------------------------------------------------------------------------------------------------------------------------------------------------------------------------------------------------------------------------------------------------------------------------------------------------------------------------------------------------------------------------------------------------------------------------------------------------------------------------------------------------------------------------------------------------------------------------------------------------------------------------------------------------------------------------------------------------------------------------------------------------------------------------------------------------------------------------------------------------------------------------------------------------------------------------------------------------------------------------------------------------------------------------------------------------------------------------------------------------------------------------------------------------------------------------------------------------------------|----------------------------------------------------------------------------------------------------------------------------------------------------------------------------------------------------------------------------------------------------------------------------------------------------------------------------------------------------------------------------------------------------------------------------------------------------------------------------------------------------------------------------------------------------------------------------------------------------------------------------------------------------------------------------------------------------------------------------------------------------------------------------------------------------------------------------------------------------------------------------------------------------------------------------------------------------------------------------------------------------------------------------------------------------------------------------------------------------------------------------------------------------------------------------------------------------------------------------------------------------------------------------------------------------------------------------------------------------------------------------------------------------------------------------------------------------------------------------------------------------------------------------------------------------------------------------------------------------------------|
| <p>1. Inventory control.—A computerized system that keeps track of product item availability, location, age, and so forth. In addition, these systems can be used to forecast product demand on a seasonal basis. The overall effect is to lower inventory yet maintain the availability to ship products to customers with little or no delay. In typical installations, working capital costs are dramatically reduced. Project life—5 years. Capital and installation costs—\$560,000. Energy savings—0 directly, but working capital could be reduced by \$1.2 million.</p> <p>2. Electric motors.—The petroleum refining industry uses electrical motors for everything from vapor recompression to mixing, pumping, and extruding. In this analysis, OTA has assumed that five aging electric motors will be replaced with newer, high-efficiency ones. Project life—10 years. Capital and installation costs—\$35,000. Energy savings—\$16,000 per year at 4¢/kWh.</p> <p>3. Catalytic reformer air preheater #1.—A typical energy conservation project in the petroleum refining industry wherein hydrogen is removed from certain organic compounds, thereby increasing the octane rating of the remaining aromatic material. Project life—10 years. Capital and installation costs—\$2 million. Energy savings—\$894,000 at 30 million Btu saved per hour.</p> <p>4. Catalytic reformer air preheater #2.—Same as above, except that major structural changes are necessary in the furnace configuration, thereby increasing installation cost. Project life—10 years. Capital and installation costs—\$3 million.</p> | <p>Energy savings—\$1394,000 at 30 million Btu saved per hour of operation.</p> <p>5. Computerized process control.—One of the most ubiquitous retrofit purchases being made for industrial systems is to add measuring gauges, controlling activators, and computer processors to existing machinery. The main accomplishment of such a process control system is to enhance the throughput and quality of a refinery with only materials and small energy inputs. Project life—7 years. Capital and installation costs—\$500,000. Energy savings—\$150,000 per year.</p> <p>6. Crude oil atmospheric distillation unit.—It is assumed that two major crude oil distillation furnaces have been in operation for many years. While relatively inefficient in energy use, the two furnaces are nevertheless still serviceable. Can their replacement be justified in energy savings alone? Project life—10 years. Capital and installation costs—\$12 million. Energy savings—\$3.2 million per year.</p> <p>7. Counterflow heat exchanger.—Installation of a counterflow heat exchanger to preheat air entering a furnace with the exhaust stack gases from the same kiln. Project life—10 years. Capital and installation costs—\$200,000. Energy savings—\$53,000 per year.</p> <p>8. Refinery boiler control system.—Installation of a computer control system to optimize burner efficiency in a boiler furnace. Project life—10 years. Capital and installation costs—\$3.75 million. Energy savings—\$820,000 per year.</p> |
|----------------------------------------------------------------------------------------------------------------------------------------------------------------------------------------------------------------------------------------------------------------------------------------------------------------------------------------------------------------------------------------------------------------------------------------------------------------------------------------------------------------------------------------------------------------------------------------------------------------------------------------------------------------------------------------------------------------------------------------------------------------------------------------------------------------------------------------------------------------------------------------------------------------------------------------------------------------------------------------------------------------------------------------------------------------------------------------------------------------------------------------------------------------------------------------------------------------------------------------------------------------------------------------------------------------------------------------------------------------------------------------------------------------------------------------------------------------------------------------------------------------------------------------------------------------------------------------------------------------------------------------------------------------------------------------------------------|----------------------------------------------------------------------------------------------------------------------------------------------------------------------------------------------------------------------------------------------------------------------------------------------------------------------------------------------------------------------------------------------------------------------------------------------------------------------------------------------------------------------------------------------------------------------------------------------------------------------------------------------------------------------------------------------------------------------------------------------------------------------------------------------------------------------------------------------------------------------------------------------------------------------------------------------------------------------------------------------------------------------------------------------------------------------------------------------------------------------------------------------------------------------------------------------------------------------------------------------------------------------------------------------------------------------------------------------------------------------------------------------------------------------------------------------------------------------------------------------------------------------------------------------------------------------------------------------------------------|

SOURCE: Office of Technology Assessment

- A shift in product mix produced by the petroleum refining industry.
- A deterioration in the quality of crude oil feedstock available to the petroleum refining industry.

As mentioned before, these trends place SIC 29 corporations in the unenviable position of having to make substantial investments to accommodate changing feedstocks and product markets in an industry whose overall growth will be negative.

These trends can be clearly seen in the modeling analyses carried out under OTA direction. Table 27 presents the OTA projection for total production in SIC 29. As shown, it decreases from a high of 14.2 million bpd in 1980 to 13.9 million bpd in 2000. At the same time, the product mix is forecast to change from a preponderance of

gasoline to an equality between gasoline and middle distillates.

The decline in energy intensity will be most rapid in the 1980-90 decade owing to projected improvements in operations and retrofit additions to enhance heat recovery (see fig. 27). Computer controls and process units, heat exchangers, regenerators, waste heat boilers, and the like are expected to improve the efficiency of existing units and fired heaters. In the following 10 years (1990-2000), new, more efficient processes should be added to refinery operations to help reduce energy intensity. These should be **processes** such as fluid coking with gasification, polymerization, and so forth. It is interesting to note that, given the projected decline in consumption of refined petroleum products, 80 percent of the expected improvement in energy efficiency in SIC

Figure 26.—Petroleum Refining Industry Projections of Fuel Use and Energy Savings by Policy Options, 1990 and 2000

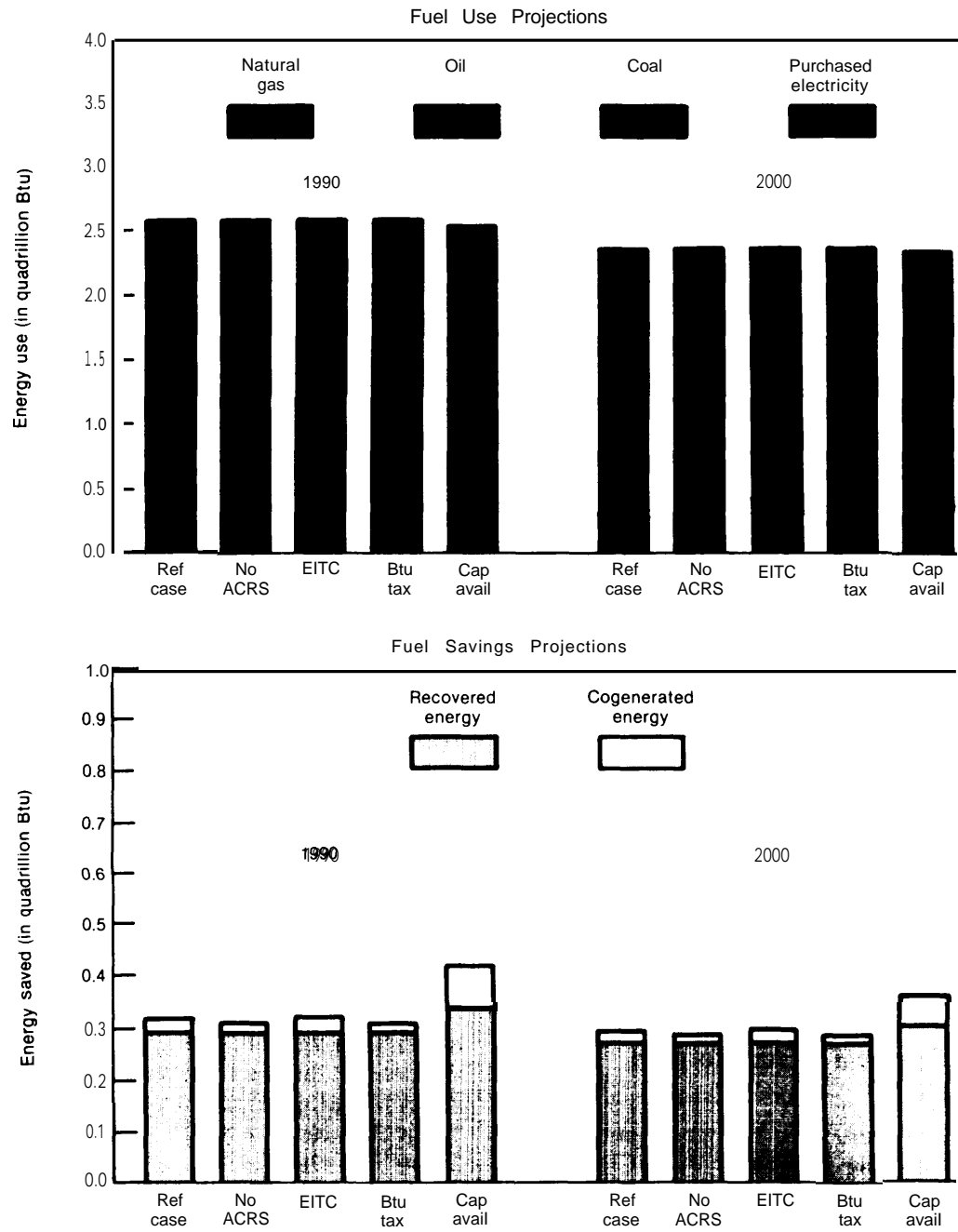

SOURCE Office of Technology Assessment

Table 27.—Projected Changes in Petroleum Refining Production Between 1985 and 2000^a

| | 1980 | 1985 | 1990 | 2000 |
|-------------------------------------------------|------|-------------|-------------|-------------|
| Gasoline | 6.4 | 6.4 (42%) | 5.7 (380/.) | 4.9 (350/o) |
| Middle distillates | 4.0 | 4.4 (290/o) | 4.7 (32%) | 4.7 (34°/0) |
| Naphtha | 0.5 | 0.6 | 0.7 | 0.9 |
| Petrochemical feedstocks ^b | 0.6 | 1.0 | 1.2 | 1.3 |
| Residual oil | 1.4 | 1.5 | 1.4 | 1.0 |
| Others ^c | 1.3 | 1.2 | 1.2 | 1.1 |
| Total | 14.2 | 15.1 | 14.9 | 13.9 |

^aIn million barrels of oil refined per day and percent.

^bOther than naphtha.

^cIncludes asphalt paving materials, Petroleum coke, lubricating oils, and the like.

SOURCES: Department of Energy, *Petroleum Supply Annual Report, 1991*; and Office of Technology Assessment projection using ISTUM.

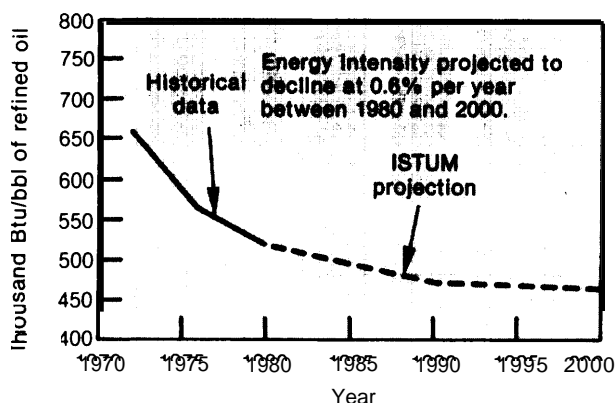
Figure 27.—Petroleum Refining Industry Energy Intensity Projection, 1970-2000

SOURCE Office of Technology Assessment

29 will be attributable to add-on energy conservation units over the next two decades. Only 20 percent will be attributable to new processes.

Projected Effects of Policy Options

Option 1: Removal of Accelerated Depreciation

OTA projects very little change in petroleum refining energy use patterns if the ACRS is removed, as shown in figure 26. There should be a slight increase in natural gas used (1 percentage point or less) and a slight increase in coal used. Cogenerated electrical energy production would be down because the depreciation in newly installed equipment would not be as rapid and would therefore be less attractive. Overall energy use is projected to increase less than 1 percentage point above that of the reference case.

This analysis is corroborated by an examination of table 28. There are no changes in any of the IRR values that are greater than 1 percentage point, nor are there any changes in the ranking of any project.

The top three projects are obviously attractive investments. They represent the type of projects corporations readily take on when energy costs begin to approach 1981 levels. And these projects maintain their attractiveness even without the added incentive of ACRS depreciation. These projects will be done, assuming capital is available, because energy, along with materials and labor, is expensive, and each of the top three projects represents a means of reducing costs without changing the nature of the products produced.

Option 2: Energy Investment Tax Credits

OTA analysis suggests a less than 1-percent change in overall energy use as a result of a 10-percent targeted **energy investment tax credit** (EITC). And, perhaps surprisingly, the change is projected to be a slight increase, as shown in figure 26. This result arises from a projected increase in cogeneration, which comes about primarily from using natural gas to produce both steam and mechanical or electrical energy. Coal use is also projected to increase by several percentage points as coal-fired boilers are used to raise steam, and coal is used for process heat.

Table 28 shows the impact of an EITC on the IRR values of representative petroleum refining

Table 28.—Effects of Policy Options on IRR Values of Petroleum Refining Industry Projects

| Project | Reference case | IRR with policy option | | |
|---------------------------------------------|----------------|------------------------|-----------------|-----------------------------------------------------|
| | | ACRS removed | 10-percent EITC | \$1/MMBtu tax on natural gas and petroleum products |
| 1. Inventory control | 87 | 87 | 87 | 87 |
| 2. Electric motors | 43 | 43 | 48 | 51 |
| 3. Catalytic air preheater #1 | 30 | 30 | 34 | 37 |
| 4. Catalytic air preheater #2 | 20 | 20 | 23 | 25 |
| 5. Crude unit furnace replacement | 17 | 17 | 21 | 24 |
| 6. Computerized process control | 16 | 16 | 22 | 19 |
| 7. Counterflow heat exchanger | 15 | 15 | 18 | 19 |
| 8. Boiler plant control system | 14 | 14 | 17 | 18 |

SOURCE: Office of Technology Assessment.

industry projects. As shown, the impact on the project was modest. Most IRR values increased by 3 to 5 percentage points, and only one project, the computerized process controller, moved **up in ranking, but only by 1 point. It is unlikely that this change in ranking would affect management's decision to take on, for example, the crude unit furnace replacement. Such factors as total cost, age of the furnace, perceived reliability of the computer process controller, and the like, would** have more impact on the decision.

in evaluating the potential effect of energy tax credits, it is necessary to recognize that applicability of such credits is not guaranteed. In order to avoid having such credits treated as just one more general investment tax credit, the Internal Revenue Service (IRS) can be expected to examine proposed applications of an energy tax credit closely. To judge from experience, IRS examinations and rulings may be expected to delay the application of such credits and to limit their use to a perceived energy-saving portion of an investment, even though the entire investment must be made in order to achieve the energy savings.

Option 3: Tax on Premium Fuel

OTA analysis suggests that a fuel price increase of \$1/MMBtu, whether in the form of a tax or market-dictated increase, would have the effect of slowing the penetration of cogeneration technology into SIC 29 relative to what is projected

to occur in the reference case. And because cogeneration is slowed, natural gas use will be less and purchased electricity will be greater than that in the reference case.

However, the greatest effect would be to promote fuel switching away from premium fuels and toward coal for both coal boilers and for hydrogen production. The combined effect of the use of more coal technologies with the decrease in cogeneration and increased purchase of electricity from utilities leads to a slight increase in total energy demand.

Table 28 presents the projected impact on IRR values of the petroleum refining projects. The fuel price increase does increase IRR values by 5 to 7 points, except for the inventory control **option, which is a project with no premium fuel use. However, none of the projects changed its relative ranking.** While the list of projects may not be all inclusive of those available to a refinery's management, it does illustrate that other factors besides IRR would be needed to change the ranking of a project.

An energy tax can have undesirable effects on the refining industry. Refining costs would increase, and product prices would necessarily follow. Imported products would become more competitive, perhaps necessitating specific *tariffs* or other measures to protect U.S. refiners and their industrial customers. And refiners would have less ability to invest in energy-saving equip-

ment to the extent that they couldn't pass on their increased costs.

Option 4: Low Cost of Capital

OTA analysis suggests that of all the legislative options examined, the low cost of capital would cause the greatest change **in energy use compared to the reference case. The low cost of capital** would promote the use of cogeneration and retrofit conservation technologies, thereby producing more self-generated electricity and a reduction in waste energy. The most significant shift in fuel mix would occur **in steam methane reforming, where partial oxidation of coal** to produce hydrogen displaces the use of natural gas.

Table 29 presents the OTA analysis of the impact of a decrease in interest rate on moneys borrowed to undertake the representative petroleum refining projects. In this instance, the reference case figures have been changed to reflect a situation where two-thirds of the money needed to finance the project is borrowed at a 16-percent interest rate. One-third of the cost would come from funds already in hand in the firm. When the interest rate is lowered to 8 percent, two of the

projects move up in ranking. Although the catalytic air preheater # 1 project would advance to the second place, it was already very attractive. Even without borrowing, the IRR value was above 30 percent with borrowing, it soars to 83 percent. The shift to above 100 percent will not significantly increase the attractiveness of an already desirable project,

Because of the decline in interest rates, all the projects have become more attractive, at least as measured by IRR values. Other factors such as total cost, plant downtime, and the like, however, would also affect the decision about whether to invest **in these projects. It must again be emphasized that investments** for energy savings have no special priority over the petroleum industry's need to spend vast amounts of capital **in essential exploration and producing activities and to adapt refineries to the changes in available crude types and to the changing demands of the products market. Many such investments will be considered necessary by industry management and thus will take priority** in discretionary capital expenditures.

Table 29.—Effect of Lower Interest Rates on IRR Values of Petroleum Refinery industry Projects^a

| Project | Reference case IRR with 16 percent interest rate | IRR with policy options: interest rate of 8 percent |
|----------------------------------------------|--------------------------------------------------|-----------------------------------------------------|
| 1. Inventory control | 385 | 370 |
| 2. Electric motors | 93 | 97 |
| 3. Catalytic air preheater #1 | 83 | 107 |
| 4. Crude unit furnace replacement | 76 | 90 |
| 5. Catalytic air preheater #2. | 70 | 89 |
| 6. Computerized process controller | 36 | 44 |
| 7. Counterflow heat exchanger | 33 | 38 |
| 8. Boiler plant control system | 413 | 59 |

^aAll projects are assumed to be two-thirds debt financed and one-third equity financed

SOURCE: Office of Technology Assessment.

Chapter 6

The Chemicals Industry

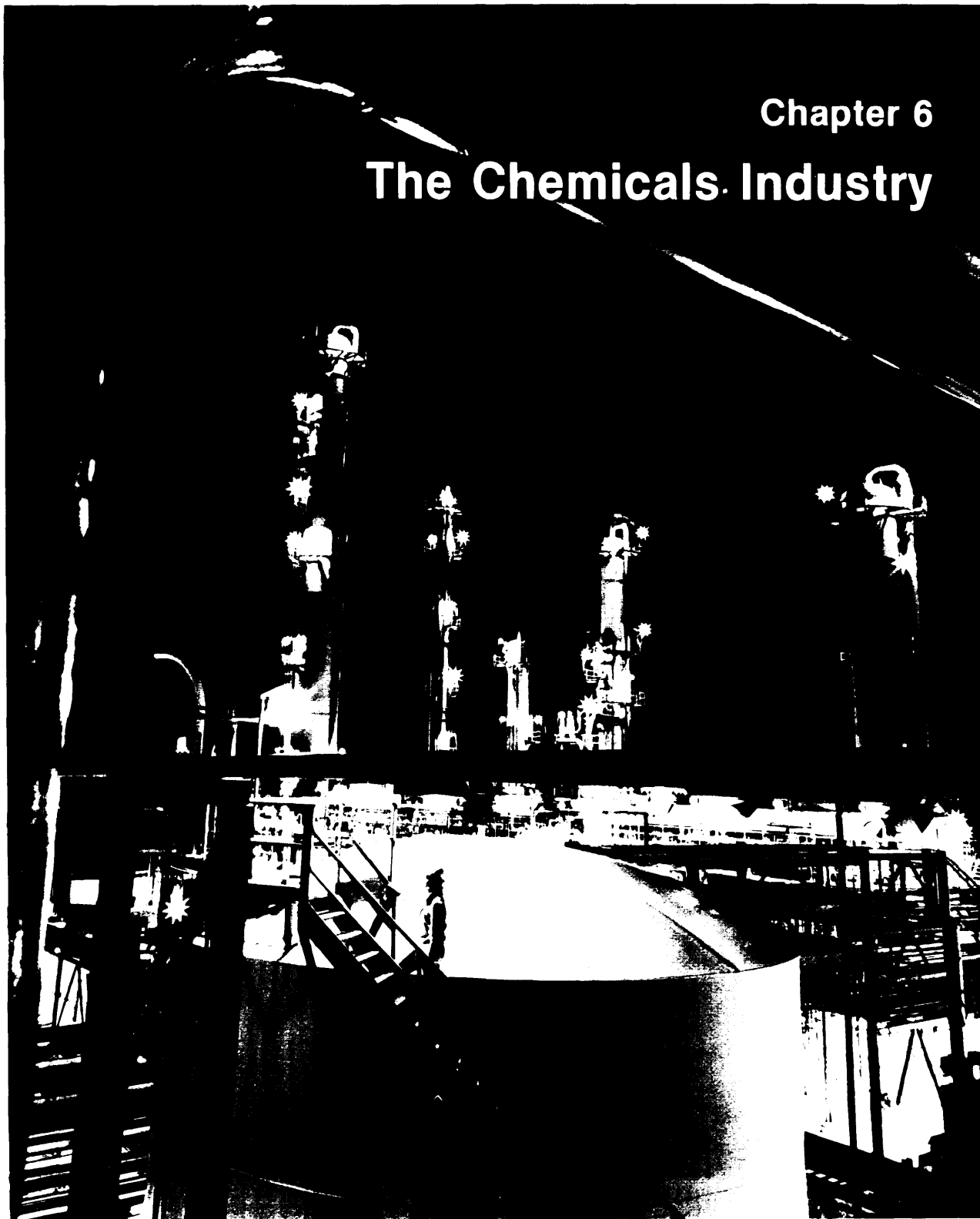

Photo credit: PPG Industries, Inc.

Contents

| | <i>Page</i> |
|-----------------------------------------------------------|-------------|
| Industry Overview | 115 |
| Industry Structure | 115 |
| Product Mix | 115 |
| Economics of Chemicals Production | 116 |
| Energy and Technology | 119 |
| Production Processes | 119 |
| Energy Use | 120 |
| Energy Conservation | 121 |
| Energy Conservation Through Technology | 126 |
| Investment Choices for the Chemicals industry..... | 128 |
| impacts of Policy Options on the Chemicals Industry | 129 |
| investment Strategy..... | 130 |
| The Reference Case | 130 |
| Projected Effects of Policy Options | 131 |

TABLES

| <i>Table No.</i> | <i>Page</i> |
|-----------------------------------------------------------------------------------------------------------------------|-------------|
| 30. Definition of SIC 28-The Chemicals and Allied Products Industry..... | 115 |
| 31. Top Ten Chemicals Produced by Chemical Industry,1981 | 116 |
| 32. Energy-intensive Processes in Chemical Manufacturing | 119 |
| 33. Comparison of 1981 and 1972 Energy Consumption in the Chemicals industry ... | 122 |
| 34. Operational and Design ProblemsinEnergy-intensive Equipment | 125 |
| 35. Operational and Design Problems in Heat-Transfer Equipment | 126 |
| 36. Funding Sources and Funding Uses of Cash Flow of Fifteen Largest Chemical Companies | 128 |
| 37. Types of Energy Efficiency-Improving Projects Undertaken by Chemical Manufacturing Association Companies | 129 |
| 38. Chemical industry Projects To Be Analyzed for Internal Rate of Return (IRR) Values | 0 131 |
| 39. Historical and Assumed Growth Rates in SIC 28 | 132 |
| 40. Reference Case Energy Use Projection, by Fuel 1980-2000 | 132 |
| 41. Reference Case Energy Use Projection, by End Use: 1985-2000 | 132 |
| 42. Reference Case Energy Use Projection, by Process Heat Fuel 1985-2000 | 132 |
| 43. Reference Case Energy Use Projection, Steam and Power Fuel 1985-2000 | 132 |
| 44. Effects of Policy Options on IRR Values of Chemical Industry Projects.. | 134 |
| 45. Effect of Lower interest Rates on IRR Values of Chemical industry projects. | 136 |

FIGURES

| <i>Figure No.</i> | <i>Page</i> |
|---------------------------------------------------------------------------------------------------------------|-------------|
| 28. Structure of Organic Chemicals Industry | 117 |
| 29. Capital Spent in the Chemicals industry, 1971-81 | 118 |
| 30. Comparison of Chemicals Industry Energy Use and Production Output, 1972 and 1981.. | 122 |
| 31. Chemicals industry Energy Intensity Projection, 1970-2000 | 132 |
| 32. Chemical Industry Projections of Fuel Use and Energy Savings by Policy Options, 1990 and 2000... | 133 |

INDUSTRY OVERVIEW

Of the **four industries chosen for study for this report**, the chemicals industry is by far the most complex. First, it produces several thousand products, in contrast to steel, paper, and petroleum refining corporations, which produce a relatively limited set of commodity products in large quantities. Second, it is more diverse—i. e., it has more capital investment choices and a less cohesive market. Within its SIC 28 classification are eight three-digit subcategories, as shown in table 30. Finally, the chemicals industry has the distinction of using the most energy of the four industries. ¹The 1980 *Annual Survey of Manufactures* shows its energy use to be 2.7 Quads, that is, 22 percent of all energy purchased by the industrial sector.

Industry Structure

More than 100 companies in the chemicals industry report **energy use data. Interestingly, over**

¹ U.S. Department of Commerce, Bureau of the Census, 1980 *Annual Survey of Manufactures: Fuels and Electric Energy Consumed*, M80(AS)-4, 1, Washington, D. C., 1982.

Table 30.—Definition of SIC 28—The Chemicals and Allied Products Industry

This major group includes establishments that produce basic chemicals and establishments that manufacture products by predominantly chemical processes. Establishments classified in this major group manufacture three general classes of products: 1) basic chemicals, such as acids, alkalies, salts, and organic chemicals; 2) chemical products to be used in further manufacture, such as synthetic fibers, plastics materials, dry colors, and pigments; and 3) finished chemical products for use by other industries, for example, paints, fertilizers, and explosives.

SIC 28 is broken down into the following eight subgroups:

| SIC | Title |
|---------------|--------------------------------------------|
| 281 | Industrial inorganic chemicals |
| 282 | Plastics and manmade fibers |
| 283 | Drugs |
| 284 | Soap, detergent, and cleaning preparations |
| 285 | Paints and varnishes |
| 286 | Industrial organic chemicals |
| 287 | Agricultural chemicals |
| 288 | Miscellaneous chemical products |

SOURCE Office of Management and Budget, *Standard Industrial Classification Manual, 1972*.

half of the top 50 chemical producers are not primarily chemicals companies. ² Many are petroleum producers and refiners, such as Exxon and Mobil. others produce chemicals only as part of their business enterprise; e.g., Eastman Kodak, Borden, and B. F. Goodrich.

OTA undertook an analysis of a number of smaller firms that produce chemical products, to determine if they exist in a different environment and behave differently than do larger firms. ³ In general, they do not. Small chemical firms tend to be the developers of new products, rather than new processes. They appear to gain competitive advantage not by producing standard products at lower cost, but by conducting research and development (R&D) that produces new products or new formulations for existing products.

Product Mix

The top 10 chemicals produced by chemical companies are shown in table 31. **Many of the top 25 chemicals produced by chemical companies** are used in agriculture, which accounts for their large production volume; among these are sulfuric acid, ammonia, and phosphoric acid. Other chemicals are used as feedstocks in the production of rubber and plastic materials, such as polyethylene and synthetic fabrics. Within SIC 286 alone, products such as plastics, synthetic rubber, nylon, and antifreeze are produced from just three material feedstocks (see fig, 28).

In the past, chemicals production depended on the large-scale production of acetylene manufactured from coal and on the development of a number of processes and products using **acetylene** as a feedstock. Acetone and acetaldehyde, originally made from acetylene, were used as raw materials for pharmaceuticals, synthetic rubber,

² *Chemical and Engineering News*, "Facts and Figures for the Chemical Industry," June 14, 1982.

³ Technology and Economics, Inc., *The Impact of Selected Federal Policies on the Energy Use Patterns of Smaller Industrial Corporations*, final report, OTA contract No. 233-4680.0, August 1982.

Table 31.—Top Ten Chemicals Produced by Chemical Industry, 1981

| Rank | Name | 1981 production (lb x 10 ¹) | 1981 production value (\$ x 10 ¹) | 1971-81 annual growth rate (%) | Produced from | Major end use |
|------|------------------------------------------------------|-----------------------------------------------|-----------------------------------------------------|--------------------------------------|-----------------------------------------------------------------------------------------------------------------------------------|-------------------------------------------------------------------------------------------------------------------------------------------------------------------------|
| 1. | Sulfuric acid (H ₂ SO ₄) | 81.35 | \$3,250 | 3.4% | Sulfur dioxide from sulfur or smelter gases: reacted with water. | Fertilizers—700/0; chemical manufacture—150/0; metals recovery and petroleum refining. |
| 2. | Ammonia (N H ₃) | 38.07 | 2,500 | 2.7 | Catalytic reaction of nitrogen (from air) and hydrogen (from natural gas). | Fertilizers—80%; plastics and textile fibers—10 ⁰ /0; explosives—5%. |
| 3. | Nitrogen (N ₂) | 37.31 | 550 | 11.2 | Separated by distillation from air at cryogenic temperatures. | Inert blanketing atmospheres: chemical processing—14%; electronics—15%; metals—5%; freezing agent—21%; aerospace—8%. |
| 4. | Lime (CaO) | 35.99 | 800 | -0.4 | Limestone (CaCO ₃) heated to remove CO ₂ , then hydrated to make Ca(OH) ₂ ; CaO. | Metallurgy (in steel flux)—45%; chemical manufacture—10 ⁰ /0; potable water treatment—10%; sewage and pollution control—50/0; pulp and paper manufacture—5%. |
| 5. | Oxygen (O ₂) | 34.93 | 525 | 2.9 | Separated from air at cryogenic temperatures. | Primary metal manufacture—300/0; health services—130/0; metal fabricating—330/0. |
| 6. | Ethylene (H ₂ C=CH ₂) | 28.87 | 7,000 | 4.6 | Thermal and catalytic cracking of hydrocarbons. | Fabricated plastics—650/0; anti-freeze—10 ⁰ /0; fibers—50/0; solvents—50/0. |
| 7. | Caustic soda (NaOH) | 21.30 | 2,500 | 1.0 | Electrolysis of salt brine. | Chemical manufacture—500/0; pulp and paper—150/0; aluminum—50/0; petroleum refining—50/0; soap and detergents—5 ⁰ /0. |
| 8. | Chlorine (Cl ₂) | 21.12 | 1,500 | 1.2 | Electrolysis of salt brine. Recovery from hydrochloric acid, coproduction in making metals, caustic potash, or potassium nitrate. | Chemical manufacture—500/0; plastics—15 ⁰ /0; solvents—150/0. |
| 9. | Phosphoric acid (H ₃ PO ₄) | 19.83 | 4,000 | 5.2 | Reaction of phosphate rock and sulfuric acid: burning elemental phosphorus and subsequent reaction with water. | Fertilizers—850/0; animal feed—5%. |
| 10. | Nitric acid (HNO ₃) | 18.08 | 2,300 | 1.7 | Reaction of ammonia with air, or sulfuric acid with sodium nitrate. | As ammonium nitrate fertilizers—950/0. |

SOURCE. Chemical and Engineering News, June 14, 1982, p. 40

textiles, and the like. Now petroleum refining is used to produce a large number of petrochemical feedstocks.⁴ For the majority of modern organic materials, acetylene has been replaced as a feedstock by other intermediates, notably ethylene and propylene, which are derived from ethane and propane, now readily available from petrochemical sources. Acetaldehyde, now also declining in importance, is currently made from ethylene rather than from acetylene. Ethanol, once derived entirely from fermentation (before 1930), is now manufactured commercially by hydration from ethylene. Acrylonitrile is now made

from propylene. Benzene and xylene, once largely obtained from coal tar, are now primarily derived from petroleum refining. Principally in response to demands for synthetic substitutes for naturally occurring industrial raw materials, especially those strategic materials whose access is controlled by foreign powers, the chemicals industry has developed new processes and technologies.

Economics of Chemicals Production

The overall economic health of the chemicals industry, compared to that of steel and petroleum refining, is good. As determined by a *Chemical*

⁴Mellon Institute, *Final Report on the Industrial Energy Productivity Project, Vol. 3, The Petroleum Refining Industry*, DOE contract No. DE-ACO1-79CS-40151, September 1982.

Figure 28.—Structure of Organic Chemicals Industry (SIC 286)

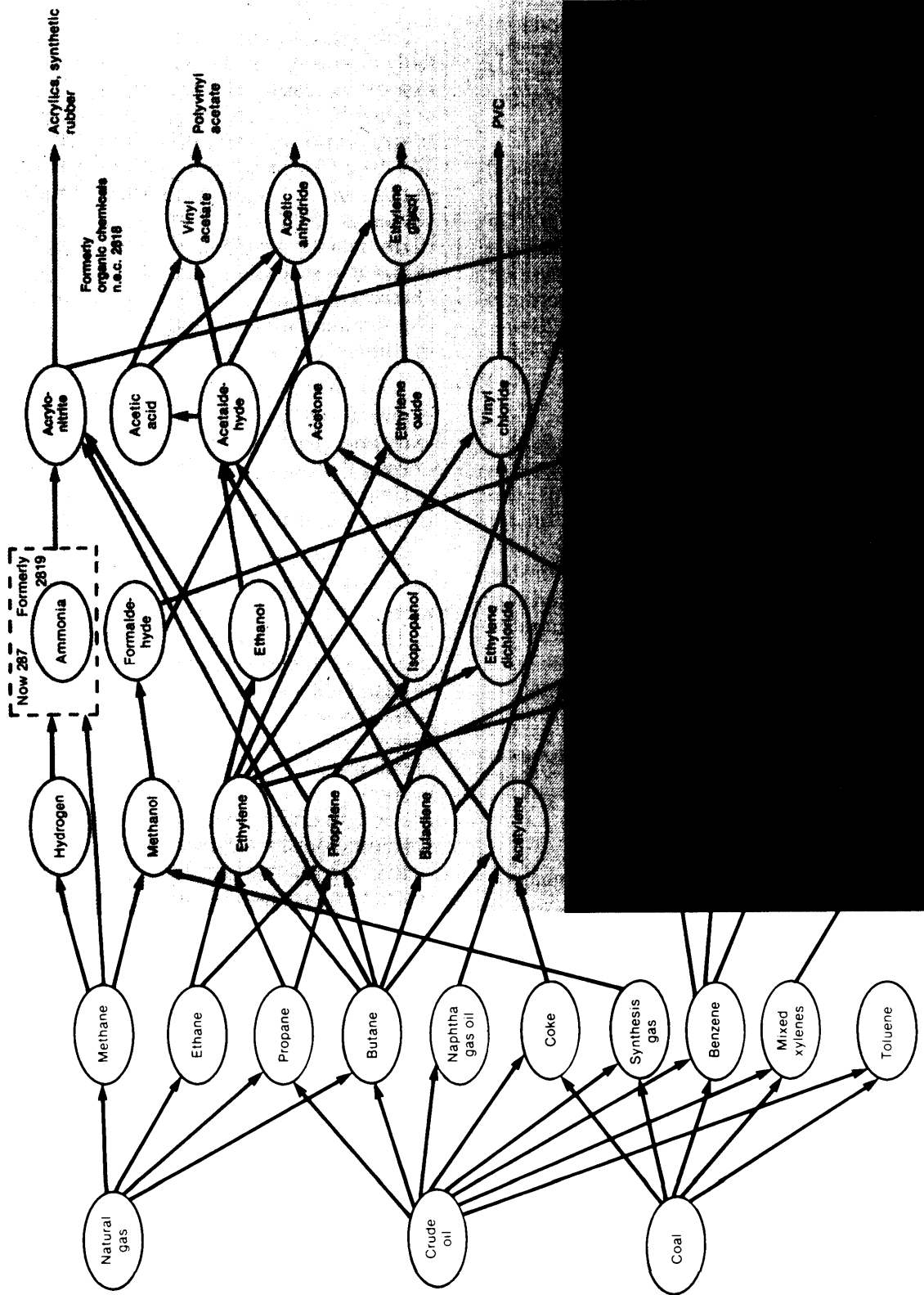

SOURCE: Mellon Institute, Final Report: The Industrial Energy Productivity Project, Volume 5, The Chemicals Industry, DOE contract No. DE-AC01-79CS-40151, September 1982.

and *Engineering News* survey,⁵ 1981 revenue was \$182 billion, with a net income of \$12.6 billion, or a 6.8-percent return, down slightly from the 1979 figure. Over the past decade, profit margins within the industry have averaged between 8 and 9 percent.

Their high profitability has allowed chemical companies to make investments in capital equipment and in research at levels much higher than those made by the other three industries studied by OTA. In 1981, the chemicals industry invested over \$13 billion in new plant and equipment, up from a 1980 level of \$12.6 billion.⁶ Figure 29 presents the capital investment trend for 1971-81.

Capital Investment

The chemicals industry spends approximately one-third as much money on research as on its entire inventory of capital projects. In 1981, this amount was estimated to be \$4.7 billion for R&D.⁷ For comparison, the proportion of funds spent on research, development, and demonstration (RD&D) by the other industries studied was 6 percent for steel, **4 percent** for petroleum refining, and 5.5 percent for paper.

⁵*Chemical and Engineering News*, "Facts and Figures for the Chemical Industry," June 14, 1982.

⁶U. S. Department of Commerce, Bureau of Economic Analysis, *1980 Annual Survey of Manufactures: Statistics for Industry Groups and Industries, A80(AS)-1*, 1982.

⁷*Chemical and Engineering News*, op. cit.

Figure 29.—Capital Spent in the Chemicals Industry, 1971-81

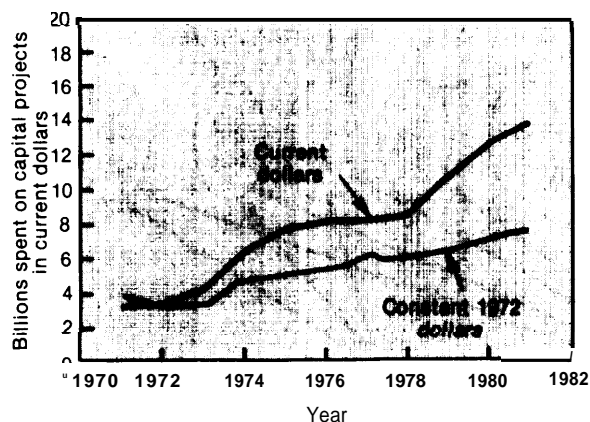

SOURCE: Bureau of Economics, Department of Commerce.

Imports and Exports

Both exports and imports increased substantially over the past decade. From **1971 to 1981, exports increased by 450 percent and imports increased by 513 percent.** The U.S. chemicals industry exported products in 1981 valued at \$21.19 billion, accounting for about 10 percent of the total U.S. exports that year. With imports valued at \$9.88 billion in 1981, a total positive trade balance resulted of over \$11 billion.⁸ Because of its extensive international trade, the U.S. chemicals industry is concerned about the implementation of tariffs and other barriers to trade in foreign countries.

In the next decade, it is predicted that the U.S. chemicals industry will export less organic chemicals and plastics and more of the specialized chemical products. It will also import more of the basic primary chemicals, process the chemicals in domestic plants, and export the final products.

U.S. producers of industrial organic chemicals are expected to have serious competition from foreign, state-owned petrochemicals complexes in Latin America and the Mideast. (However, state-operated organic chemicals plants in the Persian Gulf are not expected to be a major competitor in world markets in the near future.) Such plants, whose operations are based in part on political objectives such as job creation and foreign currency earnings, and not on the profit motive, are able to undercut the prices of U.S. suppliers. Domestic producers may thus be unable to compete in foreign markets. Unless substantial import restrictions are applied, they may have difficulty maintaining their domestic market.

producers of the two major chemicals (ammonia and phosphoric acid) used by the agricultural sector have completely different outlooks for the future in world trade. In 1985, the United States is expected to account for 25 percent of world phosphoric acid production.⁹ Exports, which have been high, should remain high for at least the next decade. Phosphate fertilizer production plants are clustered near the large sea-

⁸ibid.

⁹Mellon Institute, *Final Report on the Industrial Energy Productivity Project, Vol. 5: The Chemicals Industry*, DOE contract No. DE-AC01-79CS-401 51, September 1982.

ports in this country, reducing the necessity for more expensive rail transport. In fact, exports of phosphoric acid may be limited not by the world market competition, but by the availability of U.S. port facilities.

Ammonia producers will face a tightening foreign market in the next decade.¹⁰ Imports from

¹⁰Ibid.

relatively unreliable sources (e.g., Mexico and Russia) have increased substantially. **In 1970, ammonia imports amounted to only 3.5 percent of U.S. production. By 1978, imports were nearly 9 percent of total domestic production and have been increasing since.** This situation typifies some of the complex connections between the domestic and the international concerns of the chemicals industry.

ENERGY AND TECHNOLOGY

Production Processes

For the purposes of energy accounting, it is economical to classify the many unit operations that occur in the chemicals industry into a small number of groups. One way to identify these groups is on the basis of the equipment used to effect the chemical transformation. Table 32 presents the six most energy-intensive processes.

Table 32.—Energy-Intensive Processes in Chemical Manufacturing

Electrolysis.—Electrolysis includes all industrial electrolytic processes in which electricity is used in direct chemical conversion.

Fuel-heated reaction.—Processes that require some type of heat to force a chemical reaction to take place can be subdivided into low- and high-temperature operations. Energy sources include steam (except for high-temperature reaction), natural gas, residual oil, distillate oil, and even fluidized-bed coal combustion. Where precise temperature regulation is required, natural gas and distillate fuel oil are used.

Distillation.—Distillation processes include those that require physical separation of end products from both feedstocks and byproducts by evaporation and condensation.

Refrigeration.—Refrigeration includes processes that compress and expand a refrigerant, such as ammonia or a fluorocarbon, for the purpose of cooling feed stocks or products below ambient temperatures.

Evaporation.—Evaporation includes those processes that use passive-evaporation cooling. In general, the evaporated water is lost to the atmosphere, and the heat energy is unrecoverable.

Machine drive.—Many chemical industry processes use machine drive to pump, compress, or move feedstock and end product materials. Machine drive arises from electric motors, steam turbines, or gas turbines. A subcategory of machine drive processes—mixing and blending (especially in polymerization processes)—can be very energy intensive due to the high viscosity of the materials.

SOURCE—Adapted by OTA from Robert Ayres, *Final Report on Future Energy Consumption by Industrial Chemicals Industry*, DOE contract No DE-AC01-79CS40151, Oct 7, 1981.

As an example of how these unit processes are used to produce particular chemicals, consider the production of ethylene and ammonia.^{11 12} Both are produced in large quantities, 27 million and 38 million lb, respectively in 1980. Both consume large amounts of energy. Together, they illustrate how a typical chemical commodity is produced, when the energy is consumed, and what particular opportunities exist to use energy more efficiently.

Ethylene is used as an intermediate in the production of plastics, rubber, and synthetic fibers, which are, in turn, used in industrial and consumer products. With its byproducts and derivatives, ethylene is a cornerstone in the petrochemical industry. It is produced by the reaction of steam and hydrocarbon feedstock, followed by thermal cracking. The resulting product mixture is cryogenically cooled to -150° F and compressed to 450 to 600 psi, after which the ethylene is distilled from its feedstock and byproduct materials. The combination of heated reaction, compression, and cryogenic cooling make ethylene production very energy-intensive.

Ammonia is used as a major agricultural fertilizer, either directly or in combination with nitric acid as ammonium nitrate. It is synthesized by the reversible reaction of nitrogen and hydrogen, a reaction carried out under elevated pressures of between 80 and 1,000 atmospheres, depend-

¹¹S. D. Lyon, "Development of the Modern Ammonia Industry," 10th Brotherton Memorial Lecture, *Chemistry and Industry*, vol. 6, September 1975.

¹²L. L. Gaines and S. Y. Chen, *Energy and Material Flows in the Production of Olefins and Their Derivatives*, Argonne National Laboratories AN/LCNSV-9, August 1980.



Photo credit: PPG Industries, Inc

Major plant for the production of ethylene glycols is being readied for late 1983 operation at PPG Industries' Beaumont, Tex., complex. Pittsburgh-based PPG is a supplier of glycol for making polyester fibers, photo film, and plastic bottles

ing on the specifics of the process, and in elevated temperatures of 750° to 1,000° F. Nitrogen used in ammonia production comes from the atmosphere. Hydrogen comes from the partial oxidation and steam reforming of natural gas (i.e., producing carbon monoxide and hydrogen by partially burning natural gas hydrocarbon feedstock). The resulting product mixture must be cryogenically cooled and partially distilled to remove argon, urethane, and unreacted nitrogen byproducts. This production process is similar to that used in ethylene production in that high-temperature reaction is followed by low-temperature purification processes.

Energy Use

According to 1977 *Census of Manufactures* data for the chemicals industry, nearly 57 percent of the energy from purchased fuels and electricity came from natural gas, over 16 percent from electricity, 11 percent from coal, and 11 percent from fuel oil.¹³ Within the Industrial inorganic Chemicals subgroup, the fuel energy breakdown in 1976 was roughly as follows: natural gas, 40 percent; electricity, 40 percent; coal,

¹³U.S. Department of Commerce, Bureau of Census, *1977 Census of Manufacturers, Statistics for Industry Groups and Industries, Volume II: Industry Statistics, Part 2 SIC Major Groups 27-34, 1977.*

12 percent; and fuel oil, 8 percent. In the event of fuel shortages, manufacturers indicated that only 38 percent of natural gas needs could be met by substitute fuels (mainly fuel oil), and less than 60 percent of fuel oil needs could be met by substitute fuels (mainly natural gas).

Within the Industrial Organic Chemicals subgroup, the fuel energy breakdown in 1976 was roughly as follows: natural gas, **70 percent; coal, 8 percent; and electricity, 7 percent.** Fuel oil usage was not shown for this industry. Manufacturers indicated that only 27 percent of natural gas needs could be met quickly by substitute fuels; 32 percent of coal needs could be met by other fuels (mainly natural gas).

Many of the generating processes in the chemicals industry are energy-intensive. Generation of the number two chemical, ammonia, is one example. Most of the energy in that process is used to generate hydrogen, as well as to break the extraordinarily tight nitrogen triple bonds.

In another example, sodium hydroxide (NaOH) and chlorine (Cl₂) are produced by passing a strong electric current through an aqueous brine solution, again a very energy-intensive process. **In contrast, sulfuric acid is made via** processes which, when summed, are energy producing.

Output from the chemicals industry, as measured by the Federal Reserve Board index, rose **50 percent from 1972 to 1981**.¹⁴ **Energy use fell 4.6 percent in 1980 to below the 1972 level. The decrease (1972-81) could be seen as even larger if electricity were counted at net heat value (3,412 Btu/kWh) because part of the decrease is masked by a fairly sharp (30 percent) increase in the use of purchased electricity. The major savings from 1972 to 1981 occurred in the use of natural gas, which was down by 244 trillion Btu from 1972 to 1979 and by another 75 trillion Btu from 1979 to 1980. Use of coal and purchased steam were down slightly, while use of residual fuel oil and "other gases" was up moderately.**

One trend that has strongly affected fuel use patterns was the switch from oil to coal as a fuel for steam generation. After 1965, use of coal

declined sharply so that in 1973, coal provided 22 percent of boiler fuel. Since then, this trend has reversed; and in 1981, coal provided almost half of the fossil fuel used for steam generation.¹⁵ Some companies have forecast their use of coal for steam to increase to 70 or 75 percent by the turn of the century. Vendors state that with new packaged boiler designs (including economizers) thermal efficiencies as high as 83 percent can be obtained from coal-fired boilers—efficiencies are significantly better than with older technology. Some custom-designed units can exceed even these efficiencies by optimizing systems for particular plants.

Energy Conservation

Over the last decade, the chemicals industry has increased the efficiency of nearly all its energy-consuming processes. The efficiency of processes using natural gas, distillate oil, and residual oil has increased dramatically, while the efficiency of those processes using electricity has not changed. According to the Chemical Manufacturers Association (CMA) aggregate trade association reports, the 110 chemicals industry firms reporting in 1981 had improved their energy efficiency 24.2 percent per unit of product compared to their 1972 production (see fig. 30 and table 33).

Most improvement resulted from reduced petroleum product use; distillate fuel oil and residual fuel use dropped from a combined 211 billion to 122 billion Btu. Moreover, since 1976 there has been a 5-percent decrease in Btu consumed, most of it occurring in decreased premium fuel consumption. Du Pont, for example, improved its energy efficiency dramatically in the 1970's and early 1980's to the point where in 1981 it used only 97 percent of the energy used in 1972, while units of production—measured in constant dollar sales of product—increased by 36 percent.¹⁶ Du Pont's achievement may be slightly better than that of the chemicals industry as a whole but is probably fairly representative.

¹⁵U.S. Department of Commerce, Bureau of the Census, *Annual Survey of Manufactures: Fuels and Electric Energy Consumed*, A(72)AS-4.1 through A80(AS)-4.1.

¹⁶James Borden, Economics and Policy Manager, Energy and Materials Department, E. I. du Pont de Nemours, Inc., Wilmington, Del.

¹⁴Federal Reserve Board, *Industrial Production*, Publication LC77-93930, December 1977.

Figure 30.—Comparison of Chemicals Industry Energy Use and Production Output, 1972 and 1981

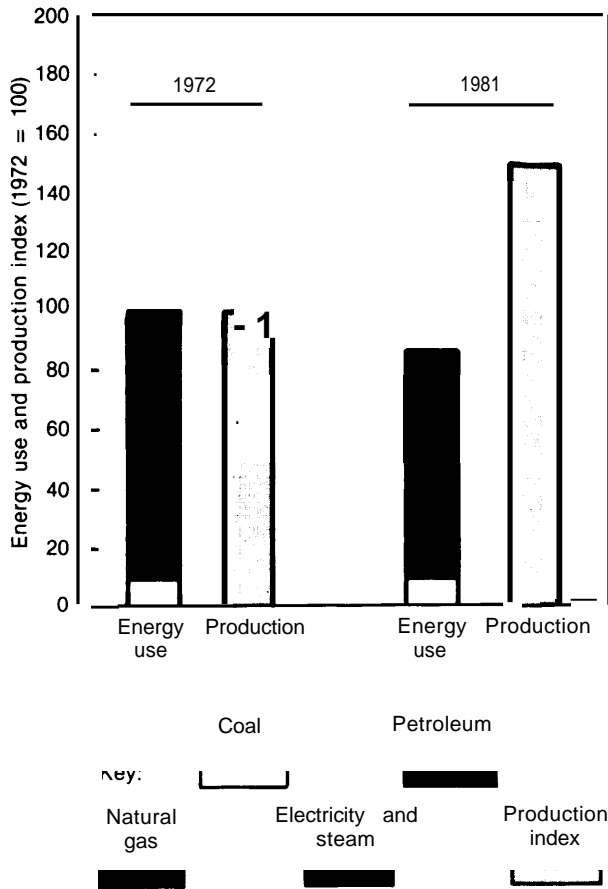

SOURCE: Chemical Manufacturing Association and Federal Reserve Board.

OTA analysis indicates that among the factors that have brought about this energy efficiency improvement are the following:¹⁷

Much of the energy savings have come from improvements in energy management techniques. This is especially true in the area of steam generation and distribution. Among the specific items identified by OTA are improved maintenance of steam lines, thermostat setbacks, and lighting.

Significant energy savings have resulted from improvements in the operating practices of fueled reactors and fired heaters. Many of these improvements have come through the use of computerized burner controls, which is a part of the overall trend in many industrial processes toward computer control with feedback optimization.

Improvements in energy efficiency over the past 8 years have not, for the most part, resulted from major process substitution. There are some exceptions including the continued phasing out of synthetic soda ash production in favor of extraction from natural sodium sesquicarbonate, and the continued substitution of the wet process for phosphoric acid production for the electric arc furnace. Overall, though, the chemical manufacturing processes that were placed in the

¹⁷Adapted from Mellon Institute, *Final Report on the Industrial Energy Project, Vol. 5: The Chemicals Industry*, DOE contract No. DE-AC01-79CS-401 51, September 1982, pp. 14-17.

Table 33.—Comparison of 1981 and 1972 Energy Consumption in the Chemicals Industry

| Energy source | 1981 consumption (billion Btu) | 1972 consumption (billion Btu) |
|-------------------------------------------|--------------------------------|--------------------------------|
| Electricity | 930,519.7 | 773,004.7 |
| Natural gas | 1,272,211.9 | 1,680,160.5 |
| Propane | 1,415.1 | 3,130.1 |
| LPG | 33,234.5 | 1,580.5 |
| Bituminous coal | 316,848.6 | 327,086.5 |
| Anthracite coal | 1,409.9 | 5,210.8 |
| Coke | 5,854.6 | 7,456.0 |
| Gasoline | 905.3 | 745.4 |
| Distillate fuel oil | 17,644.6 | 32,777.0 |
| Residual fuel oil | 104,227.3 | 178,746.1 |
| Petroleum coke | 5,118.1 | — |
| Purchased steam | 97,868.8 | 127,143.4 |
| Other gases | 346,224.2 | 358,256.5 |
| Other liquids | 44,691.2 | 50,120.7 |
| Other solids | 19,170.9 | 18,206.9 |
| Total energy consumption | 3,167,334.7 | 3,563,625.1 |

SOURCE: "Energy Efficiency Improvement and Recovered Materials Utilization Report," prepared for DOE by the Chemical Manufacturing Association, June 1, 1982.

early 1970's have **been supplanted by few new** processes that account for any sizable portion of the chemicals industry's energy efficiency improvement,

New and larger plants have saved energy without changing overall process characteristics found in older plants. Very dramatic results can often be achieved without process change when the various energy-saving options are put together in a new plant, as compared to using the same options by retrofitting an older plant. The fact that newer plants are usually larger contributes to this

record of improvement. Consider the following examples in energy efficiency improvements from plants throughout the world:

Ammonia (Haber-Bosch Process)

| Year | Energy used per ton produced (10 ⁶ Btu) |
|---------------|----------------------------------------------------|
| 1917, | 800 |
| 1923-50 | 700 |
| 1965, | 450 |
| 1972 | 400 |
| 1978 | 354 |

Source S D Lyon, "Development of the Modern Ammonia Industry." 10th Brotherton Memorial Lecture, *Chemistry and Industry*, vol. 6, September 1975, IR&T, *Industrial Energy Study of the Industrial Chemicals Group*, Vol 1, Executive Summary vol. 2, Data Base, IRT-352-R, Arlington, Va. 1974

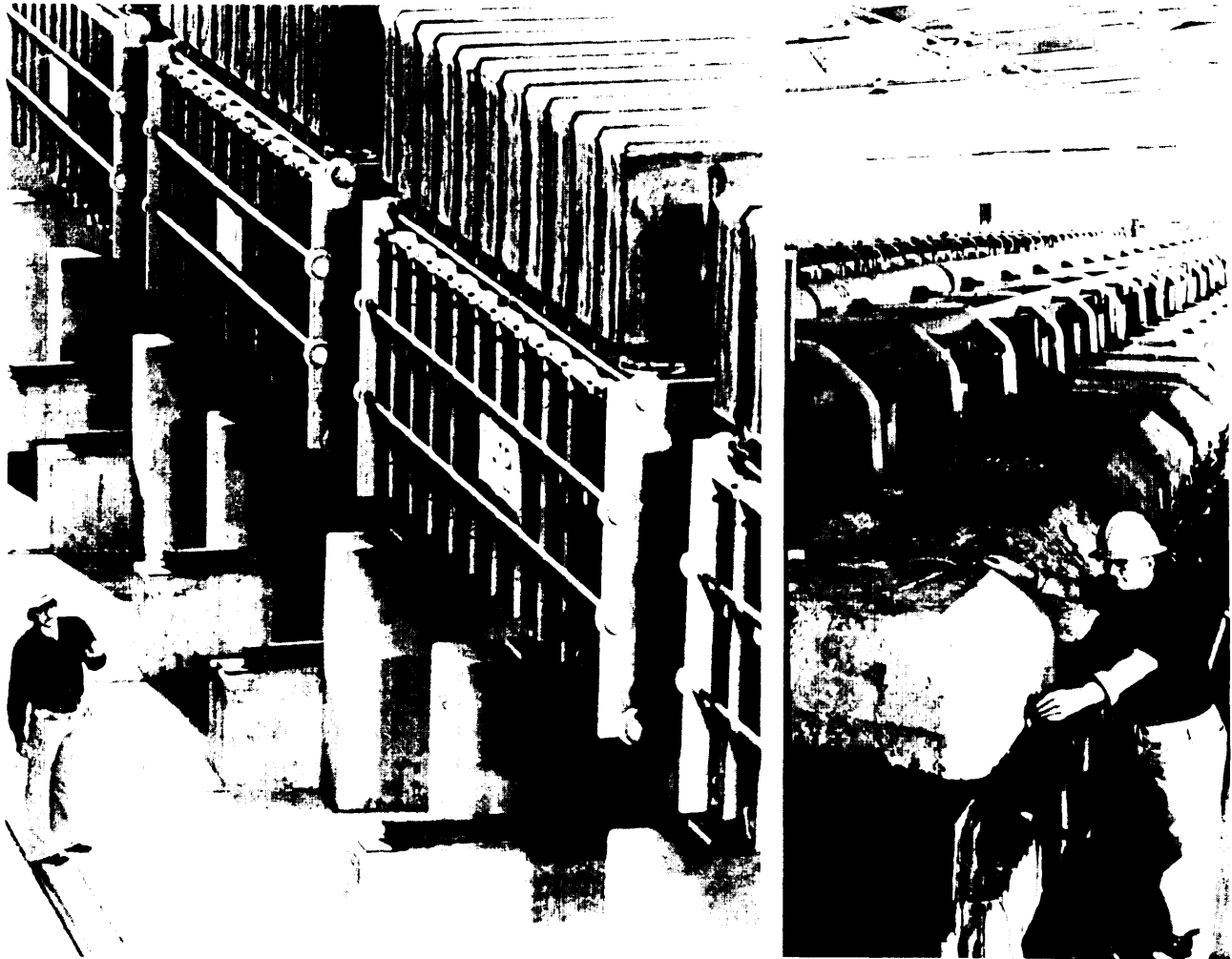

Photo credit: PPG Industries, Inc.

Bigger and better.—A workman inspects new giant-sized chlorine production units (left) similar to those that will replace outmoded units (right) at PPG Industries' Lake Charles, La., chemicals complex. New production units using PPG-developed technology will reduce by about 25 percent the amount of energy required to produce chlorine and caustic soda. Chlorine is used in making plastics and solvents, and in water purification. Caustic soda is used in chemical processing and making pulp and paper

Chlorine Cells (Diaphragm)

| Year | Electricity used per ton produced (10 ³ kWh/ton) | |
|---------|-------------------------------------------------------------|---------|
| | 1916 | 1947-73 |
| 1916 | 4,000 | 3,000 |
| 1947-73 | 3,000 | 2,200 |
| 1980 | 2,200 | |

Source The Conference Board, "Energy Consumption in Manufacturing" (Cambridge, Mass Ballinger Publishing Co., 1974), Mellon Institute, *Final Report Industrial Energy Productivity Project, vol 5 The Chemicals Industry, September 1982*

Cyclohexane (Institute Francais du Petroles Process)

| Year | Energy used per ton produced | |
|------|------------------------------|-------------------|
| | Steam (10 ³ lbs) | Electricity (kWh) |
| 1963 | 568 | 23.76 |
| 1965 | 358 | 15.00 |
| 1971 | 403 | 9.63 |

Source The Conference Board "Energy Consumption in Manufacturing" (Cambridge, Mass Ballinger Publishing Co., 1974)

The recovery of heat from exothermic or energy-producing reactions has improved. The use of heat exchangers and heat economizing is more widespread now than in 1972.

Significant improvements have been made in the design of distillation columns for physical separation. Improvements in physical separation can have salutary effects for a chemical firm. First, they can reduce fuel requirements. Second, they can often decrease feedstock requirements.

While use of premium petroleum fuels has decreased since 1972, use of electricity has increased markedly. The ammonia subsector probably accounts for part of the recent increase in purchased electricity. After 1965, most new ammonia plants incorporated single-train, centrifugal compressors, which are more economical (though less efficient) than reciprocal compressors for capacities above 600 tons per day. After 1970, there was also a brief trend toward higher compression (5,000 psi compared to 2,000 psi in earlier plants) to increase the capacity of the synthesis loop and reduce refrigeration equipment requirements. In both cases, lower capital costs were achieved at the expense of higher energy costs.

Recently, increased fuel prices (and natural gas shortages) have resulted in reversals of some of the above trends. Substantial investments in heat recovery equipment and expander turbines (to regain energy from ammonia as its pressure is reduced) have been made in response to higher

energy prices in effect since 1973. Other types of add-on units have been developed—e.g., cryogenic processes to recover hydrogen and nitrogen for recycle to the synthesis loop. In addition, most of the low-cost, high-return, housekeeping investments have been made.

Changing Feedstock Availability

A major concern of the primary chemical producers is the availability of feedstock materials. Certainly, the industry's susceptibility to a curtailment of feedstock supply was made evident during the 1973 oil embargo. The United States imports an ever-increasing amount of both organic and inorganic raw materials as it depletes its domestic resources. The chemicals industry must rely on relatively unstable countries for its supply of feedstocks.

To reduce their susceptibility to potential feedstock supply curtailments, chemical companies are increasing their flexibility in the type of raw materials they require. Olefin plants, for example, are shifting away from natural gas, ethane, and propane toward the liquid feeds (naphtha, gas oil, and eventually crude oil). Since plants that process liquid feeds are more complex, because of the initial gasification process required they are equipped to shift feedstock mixes with relative ease, although the plants are still constrained to the same general area of operations.

Shortages of natural gas in the United States have caused some feedstock shifts that are not justified on energy efficiency grounds. Most notably, natural gas is no longer the major feedstock for the production of hydrogen and acetylene. Naphtha and heavy gas oil are now the major sources of cracking feedstock, and by 1990 it would not be surprising if crude oil were cracked directly. Increased demand for byproducts such as propylene and butadiene is one of the driving forces behind this shift. The cost and scarcity of natural gas, the major feedstock for ammonia, have removed domestic producers of ammonia from the world market and made it difficult for them to compete with ammonia imports from Russia and Mexico. As a result, domestic firms have invested in researching methods for producing ammonia from coal.

Changing Feedstock Requirements

Chemical companies can reduce their total feedstock requirements by increasing conversion efficiencies. * This reduction can be done by carefully monitoring present production processes or by switching to new, more efficient production processes. Substantial increases in useful product-to-feedstock ratios can be achieved by improving product separation techniques. By carefully controlling the distillation process, a manufacturer may reduce both his feedstock and his fuel requirements. Ethylene plants have increased their production without increasing their feedstock requirements, simply by routing the by-product, propylene, through the ethylene production process.

Changing Processes

New processes that maximize conversion fractions or minimize the length of production chains have also become important in the past several years. For example, the accepted procedure for the production of acetaldehyde was from ethane, to ethylene, to ethanol, and finally to acetaldehyde. By 1980, most of the production of acetaldehyde was directly from ethylene, resulting in a 15-percent improvement in the acetaldehyde-to-ethane ratio.

*Conversion efficiency is the percentage of feedstock material that is successfully converted into a desired product.

In examining the processes for efficiently making industrial chemicals, four generalized rules become apparent:

1. High-energy feedstocks (typically hydrocarbons) lead to highly efficient (i.e., minimum number of process steps) processes for making a given chemical.
2. High-yield reactions that require only one pass through a reaction chamber or vessel are the most highly efficient means of chemical synthesis because they minimize feedstock and separation energy.
3. Energy efficiency is maximized when the need for product separations is minimized.
4. High conversion reactions recycle **energy and minimize recovery.**

In the course of the workshop meetings and case study visits carried out as part of this analysis, a number of energy-related problems were found to be generic throughout the chemicals industry—i. e., the problems were not specific to a particular chemical production facility. In tables 34 and 35, these problems are listed, along with the typical approaches that have been used **to circumvent or eliminate them.**

Table 34 describes the problems associated with the three largest energy-consuming activities in the chemicals industry—furnace operation, vapor compression, and distillation. A number of the problems involve careful attention to

Table 34.—Operational and Design Problems in Energy-Intensive Equipment

| Common problems | Measures to overcome problems |
|-------------------------------------------------------------------|-------------------------------------------------------------------------------------------------------------|
| Furnace combustion | |
| Improper air/fuel ratio | Provide instrumentation to measure oxygen content in flue gas (automatic controls) |
| Leaks in furnace stacks | Maintenance repair |
| Vapor compression | |
| Leaky compressor bypass valves | Maintenance repair |
| Excess capacity in motor or turbine | Replace with equipment matched to need |
| Improper suction pressure | Replace with equipment matched to need |
| Increasing clearance to lower output | Reduce compressor speed to lower output |
| Use of less expensive and less efficient turbines and compressors | Replace with high-efficiency equipment |
| Distillation | |
| Erratic control of columns | Provide automatic control |
| Excessive reflux, resulting in excessive component separation | Produce minimum quality material |
| Improper feed tray | Change process operation |
| Nonoptimum distillation scheme | Consider energy-saving possibilities such as multifeeds, side product draw, or cascade distillation schemes |

SOURCE Office of Technology Assessment.

Table 35.—Operational and Design Problems in Heat-Transfer Equipment

| Common problems | Measures to overcome problems |
|--------------------------------------------------------------------------------------------------------------------------|-------------------------------------------------------------------------------------------------------|
| Steam traps Faulty operation Leaking traps Mismatch between steam line pressure and trap operating range | Monitor Maintenance repair Use proper application and sizing |
| Steam tracing Leaks Unnecessarily high steam temperature | Maintenance repair Substitute another fluid for steam |
| Heat exchangers Fouling Higher than necessary temperature separation between fluid streams | Maintenance repair Design for low-temperature differences by increasing heat-transfer surface area |

SOURCE: Office of Technology Assessment.

maintenance and repair; others involve a more precise matching between the pieces of equipment used in a process— i.e., matching electric motors or gas turbines to mechanical drive requirements.

Table 35 describes the general problems found by OTA to be associated with heat-transfer equipment. Again, many of the solutions involve maintenance and more precise equipment matching.

Energy Conservation Through Technology

In considering the chemicals industry as a whole, OTA finds that there are three main areas for improving energy use: physical separation, energy recovery, and product integration.

Physical Separation Technologies

Dramatic improvements in energy use can result from changes in the physical principles embodied in certain unit operations, especially in physical separation.¹⁸ By far, the most widespread technique of chemical separation used today for mixtures of liquids is distillation. This is an energy-intensive process, especially as practiced in the former days of cheap fuel. Already, incremental improvements in the process, retrofitted to existing installations, have achieved significant (e.g., 25 percent) savings in many plants. Further improvements of comparable magnitude can be expected during the next few years through redesign and add-on units, though generally at higher

costs. Steam distillation columns provide opportunities for heat recovery in larger, integrated systems.

Alternative approaches to liquid separation include vacuum distillation, freeze crystallization, and liquid-liquid (solvent) extraction. Dramatic increases in the cost effectiveness of turbocompressors and advances in vacuum pumps and cryogenic technology since the 1950's have vastly increased the relative attractiveness of both vacuum distillation and crystallization relative to steam distillation. However, the most promising technique seems to be liquid-liquid extraction, a process using a solvent with high affinity for one component of the mixture but immiscible with the remaining components. With this technique, separation involves two steps: decanting and closed-loop evaporation/condensation of the solvent. One company has already used the technique in a synthetic fiber plant, saving an estimated 40,000 bbl of oil equivalent annually. Other applications are being actively considered.

Dehydration ("drying") using steam heat is another energy-intensive separation operation that can be dramatically improved in many cases. A technique of squeeze-drying wet solids or fabrics (prior to steam drying) can be adapted from technologies already developed in the paper industry. Separation (prior to disposal by incineration) of oily wastes or oil-soluble contaminants from water mixtures can be accomplished by using specially treated cellulose* that has an affinity for oil. The oil-soaked cellulose can subse-

¹⁸Ibid., p. A-92.

*A technique developed for oil-spill containment.

quently be burned, or squeeze-dried and then recycled.

Technologies for Energy Recovery and Conservation

This category includes both heat recovery per se and improved utilization of energy embodied in high-pressure gases or steam.¹⁹ For example, expansion turbines that recover kinetic energy from ammonia as it comes off the high-pressure synthesis loop are being increasingly used.

A variety of engineering schemes are available to recover waste heat from boilers and exothermic reactors. A "bare burner" boiler, operating with excess air to ensure complete fuel combustion, will typically produce stack gases at **600° F with 6.2 percent oxygen, a stack gas heat loss of 19 percent, and an overall thermal efficiency of 78 percent. Modest improvements in efficiency could be achieved by more precise monitoring of stack temperatures, fuel and air intake, and closed-loop** process control. More significant improvements could result from using the heat of the stack gases either to preheat intake air or intake water via an "economizer." Overall efficiency of 85 percent, with stack gas temperatures reduced to **350° F**, is readily achievable by either technique.

Many older plants used steam-driven vacuum jets instead of electric- or turbine-driven vacuum pumps because of lower capital costs. However, in a typical application, the vacuum pump is up to four times more efficient. For example, 80,000 Btu **per hour are typically** used for the electric pump versus 300,000 Btu per hour for the steam jet. Most existing steam jet-driven vacuum systems will probably be replaced by 1990, **except in those situations of low pressure and low flow** where they will continue to have an economic advantage.

Production Integration Technologies

Integration is a strategy for justifying energy and waste recovery that would not otherwise be economically justified.²⁰ The simplest example is cogeneration of electricity and steam. Most firms

in the chemicals industry have several applications of cogeneration under active consideration—in some cases, based on the use of process wastes as fuel. One company, perhaps further along than most, produced 25 percent of its 1980 electricity requirements from onsite cogeneration, a proportion expected to increase to 40 percent by 1985.

Cogeneration opportunities exist to produce electricity or mechanical shaft power as a byproduct of existing steam systems. For instance, in one plant an existing steam boiler produced 300- and 40-psi steam (as needed in the plant). By modifying the boiler to produce steam at 800 psi and 800° F, and interposing a turbogenerator (with exhausts at 300 and 40 psi), enough electricity to supply the plant was generated. Since, utility electricity normally requires 10,000 Btu to produce 1 kWh of electricity, and this operation used 4,200 Btu to produce 1 kWh of electricity, there was a net energy savings of 5,800 Btu/kWh. Many applications such as this will doubtlessly be found in the 1980's.

Potential savings from production integration extend far beyond the case of cogeneration, however. Production of intermediates, such as ethylene and butadiene, is increasingly being integrated into petroleum refining complexes. This trend will be accelerated by the shift toward heavier cracking feedstocks such as heavy gas oil or fuel oil because of the greater importance of coproduct ion.

Integration of the production of ethylene, propylene, and a wide range of petrochemicals from a naphtha-based (aromatics-based) scheme is a strong possibility by 1990. Another option would be to integrate ethylene and acetylene production with ammonia and/or methanol. Ethylene/acetylene coproduction will become increasingly attractive as distillate prices rise and heavier feedstocks are used, and will undoubtedly result in some downstream process switching as acetylene again becomes competitive with ethylene as a feedstock for acrylates, vinyl acetate, and vinyl chloride.

In the United States, at least, there is considerable interest in redeveloping coal-based chemical technologies via synthesis gas. Synthesis

¹⁹ *Ibid.*, p. A-94.

²⁰ *Ibid.*, p. A-97.

gas is currently produced mainly by steam reforming natural gas in the presence of a catalyst to yield a mixture of carbon monoxide and hydrogen (CO-H₂). This process is the basis of most commercial methanol production. In recent years, there has been a good deal of interest (supported by the Department of Energy (DOE)) in coal gasification by a similar technique, resulting in ammonia and/or methanol, the obvious first-stage chemical products. Interest in methanol is

amplified by the possibility that it may be a viable coal-based alternative to gasoline motor fuel. For these reasons a number of large-scale methanol synthesis processes are under active development. It is quite likely that methanol will grow in importance as a chemical intermediate and that a significant fraction of its 1990 production (perhaps 5 to 10 percent) will be derived from coal.

INVESTMENT CHOICES FOR THE CHEMICALS INDUSTRY

Given traditional means of accounting for corporate funds, major corporations in the chemicals industry can finance investments by either internally or externally generated funds. Within the internal category, there is net income, depreciation, deferred taxes, or advanced tax credits. From external sources, there are long-term debt and, in some cases, equity stock sources. The first part of table 36 presents data for 1979, 1980, and 1981 on the funding sources for the 15 largest chemical companies in the United States. The second part of the table shows how the 15 largest chemical companies have allocated their moneys over the past 3 years. As shown, these major corporations devoted over 50 percent of their cash flow to capital expenditures in 1980.

CMA, in reporting energy conservation improvements under DOE's Industrial Energy Reporting Program, listed the aggregate number of energy-related projects undertaken by those 110 companies participating in the CMA report. Table 37 lists the generic categories of these projects. The diversification of the projects in the list reflects the diversity of the industry itself.

It is unlikely that the trends in energy usage in the chemical industry since 1973 will simply continue. Although, it is implicitly assumed that continued rising energy costs will remain the primary force driving energy conservation, it can be assumed that the reductions that have been achieved to date are a result of implementing the

Table 36.—Funding Sources and Funding Uses of Cash Flow of Fifteen Largest Chemical Companies

| | 1979 | | 1980 | | 1981 | |
|----------------------------------------|-------------|------------|-------------|------------|-------------|------------|
| | \$ millions | % of total | \$ millions | % of total | \$ millions | % of total |
| Sources of funds | | | | | | |
| Net income | \$ 3,801 | 36.30/o | \$3,981 | 33.20/o | \$4,358 | 18.20/o |
| Depreciation and depletion | 3,602 | 34.4 | 3,818 | 31.8 | 4,267 | 17.9 |
| Deferred taxes | 427 | 4.1 | 679 | 5.7 | 1,012 | 4.2 |
| Other internal sources | 1,093 | 10.5 | 815 | 6.8 | 1,833 | 7.7 |
| Long-term debt | 1,210 | 11.6 | 2,079 | 17.3 | 7,493 | 31.4 |
| Stock | 322 | 3.1 | 630 | 5.2 | 4,931 | 20.6 |
| Total | \$10,454 | 100.0 %0 | \$12,002 | 100.00/0 | \$23,894 | 100.00/0 |
| Allocation of funds | | | | | | |
| Dividends | \$ 1,474 | 14.1 % | \$ 1,603 | 13.4% | \$ 1,845 | 7.7% |
| Capital expenditures | 5,633 | 53.9 | 7,027 | 58.5 | 8,344 | 34.9 |
| Additions to working capital | 1,075 | 10.3 | 1,057 | 8.8 | 3,759 | 15.7 |
| Reduction of long-term debt | 1,042 | 10.0 | 1,119 | 9.3 | 1,493 | 6.3 |
| Other applications | 1,230 | 11.7 | 1,196 | 10.0 | 8,453 | 35.4 |
| Total | \$10,454 | 100.0 %0 | \$12,002 | 100.0 %0 | \$23,894 | 100.00/0 |

SOURCE: *Chemical and Engineering News*, June 14, 1982, p. 43.

Table 37.—Types of Energy Efficiency-improving Projects Undertaken by Chemical Manufacturing Association Companies

New process units and technologies

• **25 companies** reported new energy efficiency-improving projects, such as replacing infrared dryers with microwave units; improving chlorine cell energy use; installing new, low-density, polyethylene production facilities; and converting high-pressure methanol manufacturing facilities to low-pressure facilities.

Improvements in existing processes

- **70 companies** reported capital projects that replaced existing equipment or added process control to existing equipment.
- **10 companies** reported projects that changed materials usage and thereby improved energy use.
- **75 companies** reported changes in plant operations that improved energy use.
- **30 companies** reported projects that improved product yield, thereby decreasing the amount of energy used per unit of production.

Housekeeping and retrofit improvements

- **64 companies** reported energy-efficiency improve merits from improved maintenance.
- **59 companies** improved their waste heat recovery.
- **70 companies** invested in improvements in power and steam operations.
- **36 companies** improved plant heating, ventilation, and air conditioning.
- **38 companies** reported improvements in energy recovered from waste materials.
- **71 companies** improved their process pipe insulation.

SOURCE "Energy Efficiency Improvement and Recovered Materials Utilization Report," prepared for DOE by the Chemical Manufacturing Association, June 1, 1982

shorter payback, more apparent, and easier to obtain energy conservation opportunities. The industry had to seek a new balance between factors of production, capital, labor, and energy. Each future reduction in **energy use will make the next increment more difficult or expensive to obtain. Moreover, a certain minimum amount of energy must be used and cannot be reduced for a given amount of industrywide output.**

The major trends within the chemicals industry appear to be as follows:

- Continued improvement in equipment efficiency and operational management.
- Improved methods of physical separation.
- More capital-intensive energy conservation and recovery projects.
- More production integration (including co-generation) to combine exothermic and endothermic reactions and utilize byproducts and waste products efficiently.
- More use of heavy gas oils and coal as feedstocks and synthesis gas in production of ammonia and methanol.
- New processes driven primarily by feedstock costs and availability.

OTA finds that there is still room for improved energy housekeeping and improved process control in many plants. Du Pont, unusual among chemical companies in that it does most of its own plant design and engineering, set up a consulting service in 1973 to sell energy conservation engineering services to other firms in the industry. Its consultants claim to be able to reduce the average client's energy bill by 20 percent, 40 percent of which can typically be achieved without major capital investment.

Moreover, equipment suppliers are constantly introducing incremental improvements—e. g., in sensors and microprocessor controls and in motor, pump, and turbine efficiencies. These changes, together with efficiencies of larger scale, would result in 10 to 20 percent better performance for most new plants in 1990 as compared to 1980, even if plant layouts were unchanged.

IMPACTS OF POLICY OPTIONS ON THE CHEMICALS INDUSTRY

In order to analyze the impacts of legislative options on the chemicals industry, OTA first made certain assumptions about economic growth rates and energy price trends that might occur between now and 2000. The assumptions, presented in tables 2 and 3 of chapter 1, were based on energy price projections of the Energy

Information Agency (EIA) that indicated that distillate fuel prices will remain relatively stable through the 1980's and then rise at a rate of 2 to 3 percent above inflation by **2000**.

In addition, OTA assumed that the following five specific trends would occur in the chemicals industry.

- Ethylene feedstocks will switch from gaseous feeds (ethane and propane) to liquid feeds (naphtha and gas oil).
- More chlorine will be produced from the diaphragm cell and less from the mercury cell.
- Ammonia and methanol production from coal via synthesis gas will become more prevalent, especially after 1990.
- Acetylene production will move toward the crude oil, submerged-flame **process**.
- **Less phosphoric acid will be produced** in electric arc furnaces.

While some of these trends were drawn purely on economic grounds, some are the result of the increasingly cautious attitude toward the use of limited feedstock resources by the industry. For example, by moving toward liquid feeds, an olefin plant will increase its feedstock flexibility because liquid feedstocks require additional vaporizing equipment, and this equipment can be used for a variety of liquid feeds.

Investment Strategy

There is some concern that small chemical firms will respond differently to policy options than will large firms. As part of the OTA analysis, case study visits were made to two small (gross revenue less than \$250 million per year) chemical companies. OTA found no difference between these firms and the larger ones in terms of their energy conservation decision making.

Smaller chemical companies do tend, however, to be motivated by a desire to produce products that have a distinct market differentiation. Whereas large firms tend to rely on high volumes and have relatively high break-even points, smaller firms seek a temporary monopoly or advantageous competitive position in some special area. For these smaller firms, it is more important to spend money differentiating their products than to minimize the cost of standard products.

Ultimately, smaller firms in the chemicals industry can be expected to respond rationally to a Government policy. OTA analysis indicates that a small firm will not take advantage of an initiative simply because it is there, unless it contributes toward the firm's objectives and coincides with its outlook for the economy.

In order to project the impacts of four legislative options, OTA used three types of analytical information. First were the observations of case study corporations and workshop participants. Their experiences and perceptions are presented in the opening paragraphs of the subsection dealing with each legislative option. Next, OTA considered a series of eight capital projects, along with their predicted energy efficiency improvements and costs. These projects were used to illustrate the changes in internal rate of return (IRR) percentages as each legislative option was applied to the series. Some of these projects were generic to all manufacturing establishments, such as replacement of older electric motors with more efficient ones or installation of process control computer facilities. Other projects were specific to the chemicals industry, for example, installation of a heat exchanger in an ammonium nitrate production plant. Table 38 presents brief descriptions of these eight projects along with a summary of the economic and energy assumptions used to calculate individual IRR percentages. Third, OTA used the Industrial Sector Technology Use Model (ISTUM). The analysis begins with the reference case.

The Reference Case

The reference case is based on the economic and legislative environment that exists for industry today and was presented previously in chapter 3. Given the chemical industry reference case, OTA assessment indicates that there will be little change in capital investment trends from that which has been observed in the past 5 years. Recent declines in energy prices may delay projects designed to facilitate fuel switching, especially those switching from distillate fuels to coal. Switching from natural gas energy sources will in all likelihood continue. It seems clear that improvements in energy efficiency will be dictated more at the direction of the economic business cycle, and by perception of opportunity of risk, than by policy.

The reference case incorporates the 1981 Economic Recovery Tax Act, with its special provisions for accelerated depreciation and safe harbor leasing.

Table 38.—Chemical Industry Projects To Be Analyzed for Internal Rate of Return (IRR) Values

1. **Inventory control**—A computerized system can keep track of product item availability, location, age, and the like. In addition, these systems can be used to forecast product demand on a seasonal basis. The overall effect is to lower inventory yet maintain the ability to ship products to customers with little or no delay. In typical installations, working capital costs are dramatically reduced.
Project life—5 years.
Capital and installation costs—\$560,000.
Energy savings—0 directly, but working capital could be reduced by \$1.2 million.
2. **Electric motors**.—The chemical industry uses electrical motors for everything from vapor recompression to mixing, pumping, and extruding. In this analysis, OTA has assumed that five aging electric motors will be replaced with newer, high-efficiency ones.
Project life—10 years.
Capital and installation costs—\$35,000.
Energy savings—\$16,000 per year at 4¢/kWh.
3. **Ammonia nitrate fertilizer plant cogeneration project**.—Installation of a turbogenerator unit to recover electrical power from a steam production facility. Superheated steam is produced at 600 psi and then passed through a mechanical turbine to generate electricity. The turbine exhaust, which is 175 psi steam, is then used for normal plant production.
Project life—10 years.
Capital and installation costs—\$231,000.
Energy savings—\$72,300 per year.
4. **Computerized process control**—The most common retrofit purchases being made for industrial systems are measuring gauges, controlling activators, and computer processors. The main accomplishment of such a process control system is to enhance the throughput and quality of a chemical production plant with only materials and small energy inputs.
Project life—7 years.
Capital and installation costs—\$500,000.
Energy savings—\$150,000 per year.
5. **Heat exchanger in nitric acid plant**.—Equipment installed to heat incoming plant gas streams with the exhaust gas from a 175 psi steam line.
Project life—10 years.
Capital and installation costs—\$155,000.
Energy savings—\$41,200 per year.
6. **Counterflow heat exchanger**.—A counterflow heat exchanger preheats air entering a kiln with the exhaust stack gases from the same kiln.
Project life—10 years.
Capital and installation costs—\$200,000.
Energy savings—\$53,000 per year.
7. **Waste heat boiler**.—Installation of a heat exchanger and waste heat boiler in an ammonia plant.
Project life—10 years.
Capital and installation costs—\$1,425,000.
Energy savings—\$351,000 per year.
8. **Ammonia plant cogeneration project**—installation of a turbogenerator unit to recover electrical power from a high-pressure, natural gas stream just before it enters the reformer burner.
Project life—10 years.
Capital and installation costs—\$816,000.
Energy savings—\$193,000 per year.

SOURCE: Office of Technology Assessment.

The gross output of the chemicals industry is anticipated to grow at a rate of approximately 4 percent per year between now and 2000. Consider data presented in table 39. Between 1969 and 1979, the industry grew at an annual rate of 5.8 percent. That growth rate will probably decline slightly as energy prices increase over the next 20 years. Under the energy price scenario of the reference case, OTA analysis projects, the fuel to be consumed and the energy service to be provided between now and 2000* (see tables 40 and 41).

Tables 42 and 43 show that process heat, which should decrease from 526 trillion to 379 trillion Btu, will shift from the proportions of 76 percent natural gas, 13 percent oil, and 11 percent electricity to those of 70 percent natural gas, 14 percent oil, and 15 percent electricity. In steam and power generation, natural gas will decrease from 70 percent of the 2,456 trillion Btu to 34 percent of the 3,180 trillion Btu predicted to be used in 2000.

Figure 31 shows that the energy intensity of the average product in the chemicals industry is projected to fall from its present value of 17.6 thousand Btu per pound of product to approximately 15 thousand Btu per pound by the end of the century. Figure 32 shows that fuel use is projected to grow only slightly from its present level of 6.8 Quads to just over 8 Quads by 2000, assuming the energy price and product growth rates built into the initial parameters of OTA's modeling efforts.

Projected Effects of Policy Options

The following sections describe the projected effects of the four policy options in comparison to changes in the chemicals industry energy use and product energy intensity in the reference case. Figure 32 presents a graphical overview of the impact of these policies.

Option 1: Removal of Accelerated Depreciation

Removal of accelerated depreciation is projected to have little impact on energy use in the

*It should be noted, once again, that energy demand projections are predicated on a set of exogenously determined energy prices and a fixed product output.

Table 39.—Historical and Assumed Growth Rates in SIC 28

| | 1969-80 | 1980-85 | 1985-90 | 1990-2000 |
|----------------------------------------------------------|---------|---------|---------|-----------|
| All manufacturing FRB ^a growth rate | 3.250/o | 3.9 %/0 | 4.3 %/0 | 3.7 %/0 |
| Chemical industry FRB ^a growth rate | 3.9 %/0 | 5.0 %/0 | 5.00/0 | 4.60/o |
| Fuel price, gas (\$/MMBtu) | — | 5.0 | 6.3 | 9.0 |
| Fuel price, residuum (\$/MMBtu) | — | 5.0 | 6.2 | 9.0 |
| Fuel price, coal (\$/MMBtu) | — | 2.2 | 2.3 | 2.4 |
| Fuel price, electricity (\$/MMBtu) | — | 13.8 | 13.7 | 13.8 |

^aFederal Reserve Board.

SOURCE: Office of Technology Assessment

**Table 40.—Reference Case Energy Use Projection, by Fuel: 1980-2000
(In million Btu)**

| Year | Gas | | oil | | Coal Fuel | Purchased electricity | Total energy |
|-----------------------|--------------|------------|------------|--------------|--------------|--------------------------|--------------|
| | Fuel | Feedstock | Fuel | Feedstock | | | |
| 1980 | 2,114 | 388 | 377 | 1,711 | 287 | 537 | 5,414 |
| 1985 | 2,085 | 371 | 369 | 2,002 | 462 | 558 | 5,847 |
| | 1,794 | 333 | 439 | 2,431 | 829 | 613 | 6,439 |
| 2000 | 1,201 | 246 | 518 | 3,268 | 1,636 | 702 | 7,571 |

^aAt 3,412 Btu/kWh.

SOURCE: Office of Technology Assessment.

**Table 41.—Reference Case Energy Use Projection, by End Use: 1985-2000
(In million Btu)**

| Year | Process heat | | Steam and power | | Machine drive | Electrolysis | Feedstocks | Total |
|----------------|--------------|--|-----------------|--|------------------|--------------|------------|-------|
| | | | | | | | | |
| 1985 | 526 | | 2,456 | | 585 | 177 | 2,163 | 5,847 |
| 1990 | 515 | | 2,640 | | 644 | 129 | 2,511 | 6,439 |
| 2000 | 379 | | 3,180 | | 681 | 151 | 3,180 | 7,571 |

SOURCE: Office of Technology Assessment.

**Table 42.—Reference Case Energy Use Projection,
by Process Heat Fuel: 1985=2000 (In percent)**

| Year | Total | Gas | Oil | Coal | Electricity | Other ^a |
|----------------|-------|-----|-----|------|-------------|--------------------|
| 1985 | 100 | 76 | 13 | — | 11 | 11 |
| 1990 | 100 | 79 | 10 | 1 | 10 | — |
| 2000 | 100 | 70 | 14 | 1 | 15 | — |

^aChemical byproducts and waste products used as fuels.

SOURCE: Office of Technology Assessment.

**Table 43.—Reference Case Energy Use Projection,
Steam and Power Fuel: 1985=2000 (in percent)**

| Year | Gas | Oil | Coal | Other ^a |
|----------------|-----|-----|------|--------------------|
| 1985 | 70 | 8 | 18 | 4 |
| 1990 | 56 | 11 | 30 | 3 |
| 2000 | 34 | 14 | 50 | 2 |

^aChemical byproducts and waste products used as fuels.

SOURCE: Office of Technology Assessment.

**Figure 31.—Chemicals Industry Energy Intensity
Projection, 1970-2000**

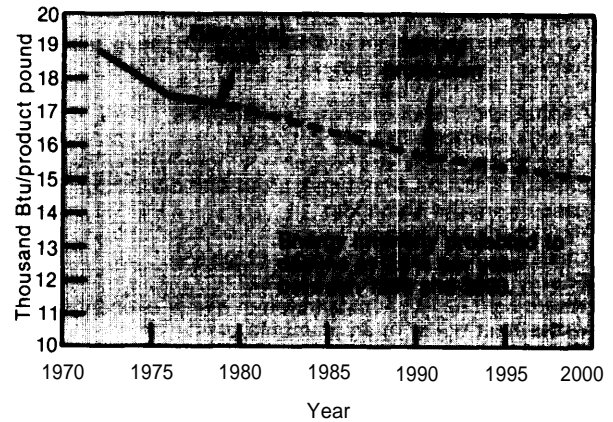

SOURCE: Office of Technology Assessment

Figure 32.—Chemical Industry Projections of Fuel Use and Energy Savings by Policy Options, 1990 and 2000

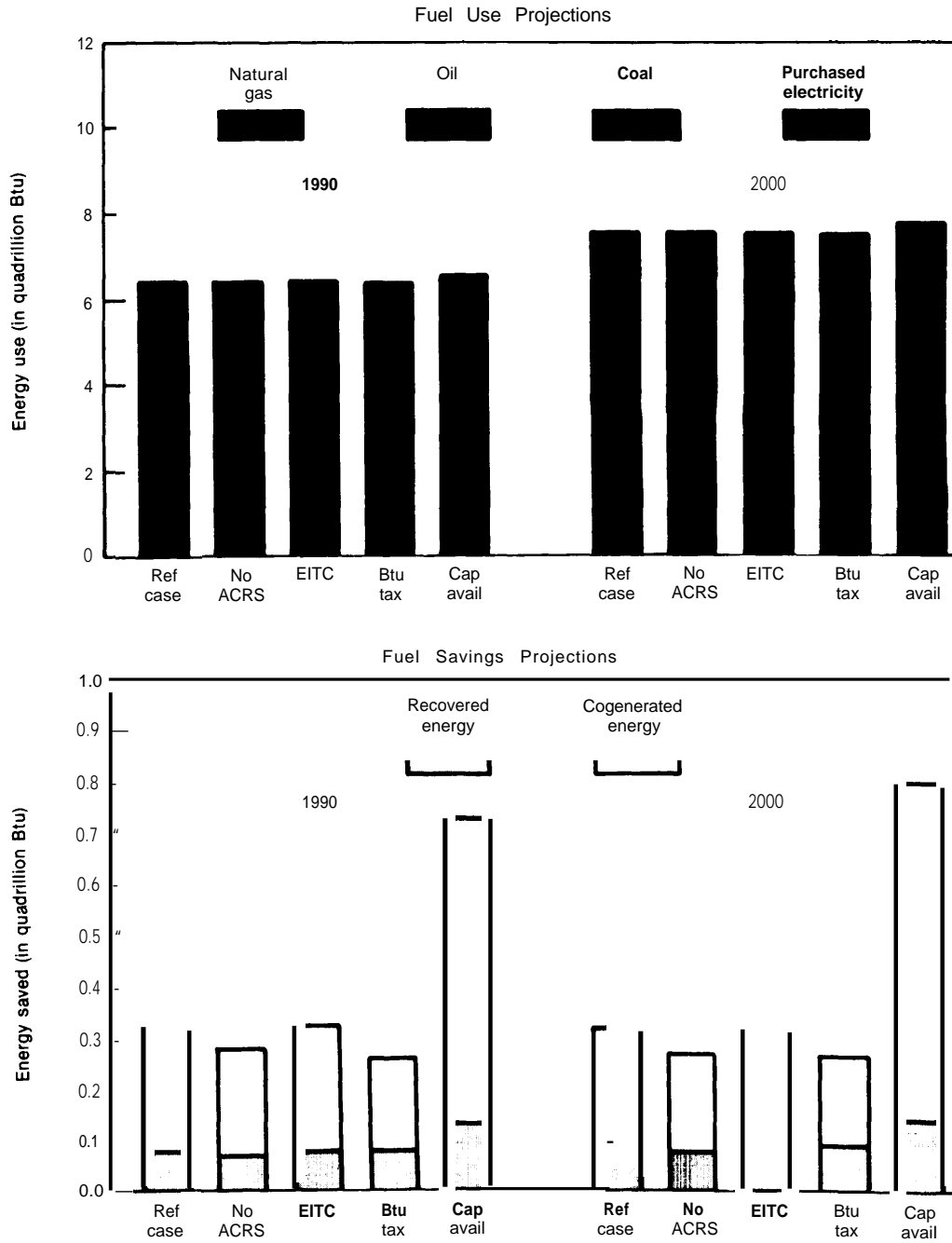

SOURCE: Office of Technology Assessment

chemicals industry, since the accelerated cost recovery system (ACRS) effects are so dependent on the general investment climate. OTA analysis indicates that the energy intensity decline with ACRS removal is coincident with the reference case energy intensity projection over the next 17 years. In addition, the fuel use projections are virtually identical for both the reference case and the removal of accelerated depreciation, as shown in figure 32.

Table 44 presents the IRR calculations of the eight chemical projects under both old depreciation and accelerated depreciation schedules. As shown, there is essentially no change between the two columns of calculations, nor is there any change in the relative rankings of each of the projects. In sum, energy use, compared to the reference case, is unaffected by removal of the ACRS depreciation schedule.

Option 2: Targeted Energy Investment Tax Credits

Targeted energy investment tax credits (EITCS) of the magnitude discussed in this report will likely have little effect on energy efficiency in the chemicals industry between now and 2000. Such incentives are perceived as having three functions. First, they are useful for increasing the IRR, thereby presumably elevating the desirability of a project that would not have met the hurdle-rate cut-off for consideration as part of a corporation's capital plan. OTA calculations show that a 10-percent EITC would change the IRR by 3 to 6 percentage points, depending on the length of

a project's lifetime. This change is not large enough to influence significantly the decision to implement a capital project. OTA **was** unable to find evidence of a chemicals project that was influenced by a 10-percent EITC.

Second, targeted tax credits increase general cash flow in an energy-intensive company. Logic would dictate that if an organization were to invest 25 percent of its funds in energy efficiency-improving capital stock, to the degree that more money is generated for investment through such a credit, 25 percent of that additional money would go to energy efficiency-improving equipment. At best, however, this is speculative. The case study firms and workshop panelists state that some energy would be saved with increased cash flow, but the amount saved is unquantifiable and very company-specific.

The third reason for justifying tax credits is to raise the awareness of corporate management that saving energy is important, not only for profitability, but also for the national interest. Although the effect of this rationale is unquantifiable, workshop panelists say it could be an important motivating influence to some organizations.

OTA analysis projects that a 10-percent EITC would produce no change in chemicals industry energy intensity from that projected in the reference case. Figure 32 shows that the fuel use patterns would be unchanged as well,

To illustrate the effect of a 10-percent EITC on the IRR, the eight chemical industry projects

Table 44.—Effects of Policy Options on IRR Values of Chemical Industry Projects

| Project | Reference case | ACRS removed | 10-percent EITC | Policy option \$1/MMBtu tax on natural gas and petroleum products |
|----------------------------------------------------|----------------|--------------|-----------------|-------------------------------------------------------------------|
| 1. Inventory control | 87 | 87 | 87 | 87 (No fuel) |
| 2. Electric motors | 43 | 43 | 48 | 51 (Electric) |
| 3. Fertilizer plant cogeneration project | 18 | 18 | 20 | 18 (Coal) |
| 4. Computer process control | 16 | 16 | 22 | 19 (Oil) |
| 5. Nitric acid plant heat exchanger | 15 | 15 | 18 | 21 (N. Gas) |
| 6. Counterflow heat exchanger | 15 | 15 | 18 | 19 (Oil) |
| 7. Waste heat boiler | 11 | 11 | 14 | 16 (N. Gas) |
| 8. Ammonia plant cogeneration project | 11 | 11 | 15 | 17 (Gas) |

SOURCE: Office of Technology Assessment.

previously described were analyzed with and without the tax credit. In table 44, the IRR for each project is presented. As shown, only two projects—projects 4 and 8—changed their relative rankings. However, such changes are unlikely to cause projects 4 and 8 to be undertaken at the expense of projects 3 and 7. There might be other factors which the investment tax credit might supplement or bolster to cause the project to be undertaken, but the tax credit alone would not be so motivating.

Option 3: Tax on Premium Fuels

OTA's assessment of the impact of a fuel tax of \$1 -per-million-Btu fuel tax on natural gas and distillate fuels is that it would have a positive effect on improving energy efficiency but could have an overall negative effect on the U.S. chemicals industry with respect to foreign competition.

OTA's ISTUM analysis projects a premium fuels tax to have little effect on energy use in the chemicals sector. The energy intensity of chemicals industry products is projected to be within a percentage point of being identical to that of the reference case. However, as shown in figure 32, fuel use patterns are projected to shift slightly. A premium fuels tax would cause natural gas consumption to fall by approximately 10 percent, while coal would increase by a similar amount. [It is also noteworthy that a premium fuels tax would decrease cogeneration of electricity, since the most reliable and efficient fuel in cogeneration units is natural gas. OTA projects that cogeneration could fall by 25 percent under the premium fuels tax scenario.

If a premium fuels tax were to be levied, multinational chemical companies would probably build production facilities outside U.S. boundaries in order to take advantage of lower energy prices. The products would then be imported to the United States or shipped to other countries. In either case, this would adversely affect U.S. balance of payments, since chemical trade generated an \$11 billion positive flow in 1981.

The fuels tax would also change the IRR percentages, as indicated in table 44. The effect of the fuel tax on the eight sample projects would

be more pronounced than in the case of the EITC. The gain in the IRR was almost 6 percentage points for project 5, the nitric acid plant heat exchanger, for example. The overall effect on most of the projects was to increase the IRR overall by 4 to 6 points.

Option 4: Low Cost of Capital

At present, the availability of capital is *not* a major constraint in the chemicals industry. The chemicals industry has been profitable over the last 10 years, especially compared to the steel industry. High interest rates have not hurt chemical firms directly, although they have indirectly decreased the demand for chemical products in the housing and auto industry. Moreover, chemical companies have been able to borrow funds where needed. Although making funds available for general investment at lower interest rates does have an impact on the IRR, the energy, employment, and capital investment consequences are, at best, difficult to estimate.

Energy intensity is projected to fall in approximately the same fashion with the capital availability option as in the reference case, although the projected level is slightly higher than with the reference case. Figure 32 shows that with less expensive capital, chemicals industry firms would install more cogeneration capacity, and thereby decrease purchased electricity demand while increasing natural gas use. In a sense, this increase is an energy accounting artifact. Fuel use is being switched from public utilities to the industrial sector. As with all cogeneration, the effect on the energy economy is to make the United States more energy efficient with cogeneration, even though it looks less efficient for the chemicals industry.

In order to illustrate the effect of lower interest rates on IRR, OTA first assumed that the chemicals industry projects would be funded by debt financing. In the analysis, shown in table 45, those projects that were good investments at the outset continued to be good investments with the change in interest rates. While the IRR values changed slightly, none surpassed the others with a low cost of capital option.

Table 45.—Effect of Lower Interest Rates on IRR Values of Chemical Industry Projects^a

| Project | Reference case IRR with 16% interest rate | IRR with policy options: interest rate of 8% |
|----------------------------------------------------|----------------------------------------------|-------------------------------------------------|
| 1. Inventory control | 385 | 370 |
| 2. Electric motors | 93 | 97 |
| 3. Computer process control | 36 | 44 |
| 4. Nitric acid plant heat exchanger | 35 | 39 |
| 5. Counterflow heat exchanger | 33 | 38 |
| 6. Ammonia plant cogeneration project | 27 | 31 |
| 7. Fertilizer plant cogeneration project | 26 | 28 |
| 8. Waste heat boiler | 24 | 27 |

^aAll projects are assumed to be two-thirds debt financed and one-third equity financed,
SOURCE: Office of Technology Assessment.

Chapter 7

The Steel Industry

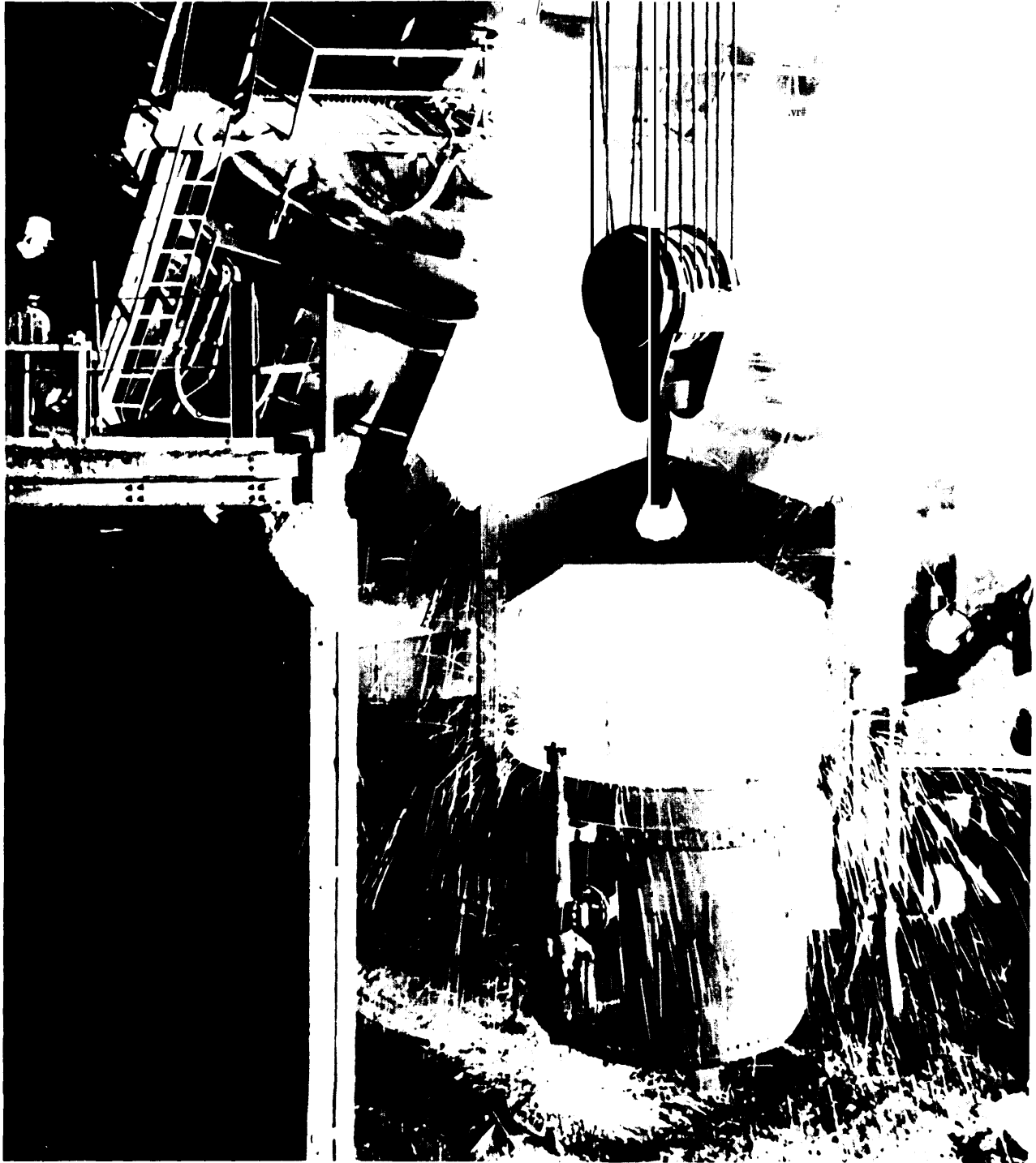

Photo credit American Iron and Steel Institute

Contents

| | Page |
|-------------------------------------------------|------|
| Industry Overview | 139 |
| Industry Structure | 139 |
| Economics of Steel Production | 141 |
| Energy and Technology | 145 |
| Production Processes | 145 |
| Energy Use | 149 |
| Energy Conservation | 152 |
| Electric Arc Furnace | 152 |
| Continuous Caster | 153 |
| Investment Choices for the Steel Industry | 155 |
| Investment Strategy | 155 |
| Specific Energy-Related Investments | 156 |
| Policy Impacts on the Steel Industry | 156 |
| The Reference Case | 156 |
| Projected Effects of Policy Options | 158 |

TABLES

| Table No. | Page |
|----------------------------------------------------------------------------------------------|------|
| 46. Definition of SIC 33—The Primary Metals Industry | 139 |
| 47. Steel Shipments by Major U.S. Companies, 1976 | 140 |
| 48. Capacities of Steel Plants in the United States, 1978 | 140 |
| 49. Raw Steel Production by State, 1980 | 141 |
| 50. Projection of Product Mix in U.S. Steel Production, 1976-2000 | 141 |
| 51. Energy Services and Major Processes in the Iron and Steel Industry | 145 |
| 52. Fuel Use and Energy-Related Trends in the Steel Industry | 152 |
| 53. Comparison of 1981 and 1972 Energy Consumption for U.S. Steel Companies | 153 |
| 54. Technologies for Improving Energy Efficiency in the Steel Industry | 154 |
| 55. Historical and Projected Growth Rates for Production and Fuel Prices, 1976-2000 | 157 |
| 56. Fuel Use Summary: Reference Case, 1980-2000 | 157 |
| 57. Steel Industry Projects To Be Analyzed for Internal Rate of Return (IRR) Values ... | 158 |
| 58. Effects of Policy Options on IRR Values of Steel Industry Projects | 159 |
| 59. Effect of Lower Interest Rates on IRR Values of Steel Industry Projects | 162 |

FIGURES

| Figure No. | Page |
|---------------------------------------------------------------------------------------------------|------|
| 33. U.S. Capital Investment in Steel Industry, 1971-82 | 142 |
| 34. Process Flows in the Iron and Steel Industry | 146 |
| 35. Cross-Section of a Typical Continuous Casting Machine | 150 |
| 36. Energy Consumption by Production Process in a Typical Integrated U.S. Steelmaker | 151 |
| 37. Comparison of Steel Industry Energy Use and Production Output, 1972 and 1981 | 153 |
| 38. Iron and Steel Industry Energy Intensity Projections, 1970-2000 | 157 |
| 39. Steel Industry Projections of Fuel Use and Fuel Savings by Policy Options, 1990-2000 | 160 |

INDUSTRY OVERVIEW

Steel is made from iron ore, iron scrap, coal (converted to coke), and limestone. It is one of the largest and most versatile bulk commodities in commercial use, having many structural applications and competing successfully with other structural materials, such as aluminum, plastics, and wood, for a variety of markets. International competition within the steel industry has reduced U.S. production and is forcing major modernizing investments, despite dim future prospects and relatively limited investment capital. Among other efficiency gains, these investments are dramatically reducing the energy input per ton of steel. *

Historically, steel production has followed the business cycle because a large share of steel is used for highly cyclical construction and consumer durables.¹ After hitting a peak of over 100 million tons of steel shipped in 1979, the industry has been especially hard pressed because the Nation has experienced its worst recession since the 1930's and because import competition has steadily intensified.² In 1981, the domestic steel industry shipped 87 million tons of product (up 4 million tons from 1980) and on the average about 79 percent of raw steel making capacity was in operation. In 1982 shipments plummeted to just under 60 million tons and less than 50 percent of capacity was utilized.³

Industry Structure

The domestic steel industry, classified as SIC 3312 includes blast furnace-based integrated steelmaker, nonintegrated minimills, and independent producers of wire, bars, and pipe who

purchase and process semifinished steel (see table 46). In 1977, 396 companies operated 504 plants and employed 442,000 people. The 91 million tons of steel they shipped had a value of \$36.2 billion and represented about 1.9 percent of the U.S. gross national product (GNP).⁴ Of these companies, the top 16 companies accounted for approximately 83 percent of blast furnace and steel mill product shipments (see table 47).

Steel producers can be classified as either integrated or nonintegrated. Nonintegrated mills are further divided into minimills and specialty

⁴Ibid., and U.S. Department of Commerce, Bureau of the Census, *Statistical Abstract of the United States, 1980*, pp. 437, 444.

Table 46.—Definition of SIC 33—The Primary Metals Industry

This major group includes establishments engaged in the smelting and refining of ferrous and nonferrous metals from ore, pig, or scrap; in the rolling, drawing, and alloying of ferrous and nonferrous metals; in the manufacture of castings and other basic products of ferrous and nonferrous metals; and in the manufacture of nails, spikes, and insulated wire and cable. This major group also includes the production of coke. Establishments primarily engaged in manufacturing metal forgings or stampings are classified in Group 346.

The major 3-digit industries are:

| SIC | Title |
|-----------|--------------------------------------------------------------|
| 331 . . . | Blast furnaces, steel works, and rolling and finishing mills |
| 332 . . . | Iron and steel foundries |
| 333 . . . | Primary smelting and refining of nonferrous metals |
| 334 . . . | Secondary smelting and refining of nonferrous metals |
| 335 . . . | Rolling, drawing, and extruding of nonferrous metals |
| 336 . . . | Nonferrous foundries (castings) |
| 339 . . . | Miscellaneous primary metal products |

Within SIC 331, 4-digit industries include:

| SIC | Title |
|------------|-----------------------------------------------------------------------|
| 3312 . . . | Blast furnaces (including coke ovens), steel works, and rolling mills |
| 3313 . . . | Electrometallurgical products |
| 3315 . . . | Steel wire drawing and steel nails and spikes |
| 3316 . . . | Cold rolled steel sheets, strips, and bars |
| 3317 . . . | Steel pipe and tubes |

SOURCE: Office of Management and Budget, *Standard Industrial Classification Manual, 1972*

● For more information, see table 53 and fig. 37.

¹*Technology and Steel Industry Competitiveness, ch. 5* (Washington, D. C.: U.S. Congress, Office of Technology Assessment, OIA-M-122 June 1980)

²Robert W. Crandall, *The U.S. Steel Industry in Recurrent Crisis: Policy Options in a Competitive World* (Washington, D. C.: The Brookings Institution, 1981); and American Iron and Steel Institute, *Steel at the Crossroads: The American Steel Industry in the 1980s*, ch. 2, 1980.

³American Iron and Steel Institute, *Annual Statistical Report for 1981* (May 1982) and 1982 (unpublished).

Table 47.—Steel Shipments by Major U.S. Companies, 1976

| | Steel shipments | |
|----------------------------------------|-----------------------|------------------|
| | Thousands of net tons | Percent of total |
| United States Steel Corp. | 19,486 | 21.8 |
| Bethlehem Steel Corp. | 12,600 | 14.3 |
| National Steel Corp. | 7,644 | 8.8 |
| Republic Steel Corp. | 6,535 | 7.3 |
| Inland Steel Co. | 5,600 | 6.3 |
| Armco Steel Corp. | 5,082 | 5.7 |
| Jones & Laughlin Steel Corp. | 5,097 | 5.7 |
| Lykes-Youngstown Corp. | 3,388 | 3.8 |
| Wheeling-Pittsburgh Steel Corp. | 2,816 | 3.1 |
| Kaiser Steel Corp. | 1,616 | 1.8 |
| McLouth Steel Corp. | 1,639 | 1.8 |
| CF&I Steel Corp. | 1,101 | 1.2 |
| Interlake, Inc. | 797 | 0.9 |
| Northwestern Steel & Wire Co. | 839 | 0.9 |
| Cyclops Corp. | 849 | 0.9 |
| Allegheny-Ludlum Industries, Inc. | 383 | 0.4 |
| Major company total | 75,872 | 84.7 |
| Industry total | 89,450 | 100.0 |

SOURCE: "1976 Steel Industry Financial Analysis," Iron Age, Apr. 25, 1977.

steel companies (see table 48). In integrated plants, the primary source of iron is iron ore in the form of lump ore, sinter, or pellets. Iron ore is converted into steel through a series of processing steps, including production of coke, pig

iron, raw steel, and steel products. Minimills are generally much smaller, have more limited product lines, and one less stage of production since the process begins with steel scrap or directly reduced iron, feedstocks that do not require gross refining in a blast furnace (see table 48). Specialty companies are also smaller, but have a much larger number of specialized products than do minimills. Both smaller operations rely primarily on the electric arc furnace to make molten metal, but the specialty producer tends toward higher grade ferrous scrap and refined alloy metals in order to make high performance goods.

The annual production capacities of steel plants operated by the three major sectors of the steel industry are shown in table 48. With respect to the scale of production in U.S. plants, **46 of the 50 plants with raw steel productive capacity above 1 million tons per year in 1978 were owned by the 17 integrated companies. In contrast, all but one of the 54 plants operated by 43 scrap-based companies had annual production capacities below 1 million tons. All but nine of the scrap-based plants had less than half of that**

Table 48.—Capacities of Steel Plants in the United States, 1978

| Size-range raw steel capacity, tonnes/yr | Number of plants operated by the — | | | Total number of plants in size range |
|------------------------------------------|------------------------------------|-------------------------|-------------------------------------|--------------------------------------|
| | 17 integrated companies | 33 speciality companies | 43 scrap/DRI* companies (minimills) | |
| 7,256,000-8,162,999. | 2 | 0 | 0 | 2 |
| 6,349,000-7,255,999. | 1 | 0 | 0 | 1 |
| 5,442,000-6,348,999. | 1 | 0 | 0 | 1 |
| 4,535,000-5,441,999. | 3 | 0 | 0 | 3 |
| 3,628,000-4,534,999. | 4 | 0 | 0 | 4 |
| 2,721,000-3,627,999. | 9 | 0 | 0 | 9 |
| 1,814,000-2,720,999. | 11 | 0 | 1 | 12 |
| 907,000-1,813,999. | 15 | 3 | 0 | 18 |
| 816,300- 906,999. | 1 | 0 | 0 | 1 |
| 725,600- 816,299. | 0 | 0 | 1 | 2 |
| 634,900- 725,599. | 0 | 0 | 1 | 1 |
| 544,200- 634,899. | 1 | 3 | 3 | 7 |
| 453,500- 544,199. | 1 | 1 | 3 | 5 |
| 362,800- 453,499. | 1 | 1 | 4 | 6 |
| 272,100- 362,799. | 2 | 1 | 5 | 8 |
| 181,400- 272,099. | 2 | 2 | 14 | 18 |
| 144,190- 181,399. | 1 | 2 | 6 | 9 |
| 126,980- 144,189. | 0 | 2 | 4 | 6 |
| 90,700- 126,979. | 0 | 10 | 9 | 19 |
| 68,025- 90,699. | 0 | 3 | 2 | 5 |
| 45,350- 68,024. | 2 | 10 | 9 | 21 |
| 22,675- 45,349. | 0 | 5 | 0 | 5 |
| 0- 22,674. | 0 | 3 | 0 | 0 |

*DRI = directly reduced iron (see p. 153).

SOURCE: American Iron and Steel Institute.

productive capacity because, in general, profit rates were greater for small plants that bought scrap and sold products within a single region.

The centers of integrated steel production continue to be in the traditional industrial areas of the North Central and Eastern States (see table 49). The smaller, scrap-based companies tend to be distributed more uniformly among general population and manufacturing centers.

The major forms of steel are sheet and strip, structural and plate, bars, pipes and tubes, wire and wire products, and tin mill products. Major markets for steel include the automotive, construction, machinery and equipment, containers and packaging, and oil and gas industries and steel service centers. In 1980, the distribution of steel products by grades was 84.7 percent carbon steel, 13.8 percent alloy steel, and 1.5 percent stainless steel. A projection of steel product mix is shown in table 50.

Economics of Steel Production

Profitability

In recent years, the slowing demand for U.S. steel has resulted in low or negative profits for many U.S. steel producers. Capital-intensive industries like steel are the most severely penalized by accelerating inflation and highly cyclical economic conditions. From 1967 to 1980, steel mill

Table 49.—Raw Steel Production by State, 1980

| States | Thousands of tons |
|-------------------------------------------------------------------------------------------------------|-------------------|
| Pennsylvania | 23,517 |
| Indiana | 19,820 |
| Ohio | 16,100 |
| Illinois | 8,961 |
| Minnesota, Missouri, Oklahoma, Texas, Nebraska, and Iowa | 8,642 |
| Michigan | 7,877 |
| Virginia, West Virginia, Georgia, Florida, North Carolina, South Carolina, and Louisiana | 6,066 |
| Rhode Island, Connecticut, New Jersey, Delaware, and Maryland | 5,161 |
| Arizona, Colorado, Utah, Washington, Oregon and Hawaii | 4,795 |
| Alabama, Tennessee, Mississippi, and Arkansas | 3,452 |
| New York | 2,675 |
| California | 2,628 |
| Kentucky | 2,141 |
| Total | 111,835 |

SOURCE: American Iron and Steel Institute.

Table 50.—Projection of Product Mix in U.S. Steel Production, 1976-2000

| Product | Distribution in percent | | | |
|---------------------------------------|-------------------------|------|------|------|
| | 1976 ^a | 1980 | 1985 | 1990 |
| Structural | 10 | 12 | 12 | 12 |
| Plate | 9 | 10 | 10 | 10 |
| Rails | 2 | 2 | 2 | 2 |
| Hot-rolled bars | 9 | 7 | 7 | 7 |
| Other bars | 7 | 9 | 9 | 9 |
| Pipes and tubes | 9 | 11 | 13 | 15 |
| Wire | 3 | 3 | 2 | 2 |
| Tin mill products | 7 | 7 | 6 | 6 |
| Hot-rolled sheet and strip | 17 | 15 | 15 | 14 |
| Cold-rolled sheet and strip | 20 | 17 | 16 | 15 |
| Galvanized sheet | 7 | 8 | 8 | 8 |

^aAverage of 1975.77 used to eliminate fluctuations.

SOURCE: American Iron and Steel Institute and the Office of Technology Assessment.

product prices rose 22.6 percent faster than consumer prices, while the average real rate of return after inflation in the steel industry, which remained around 10 to 11 percent throughout the early 1950's, declined steadily after 1955 and fell **to below zero in the mid-1970's. Moreover, profitability in steel production was not uniform.** The average rate of return on investment for major integrated steel companies was 1.4 percent in 1977 and 6.2 percent in 1978. Nonintegrated steel companies had an average rate of return on investment of 6.2 percent in 1977 and 12.3 percent in 1978. Alloy and specialty steel companies had average rates of return on investment of 9.1 percent in 1977 and 11.1 percent in 1978.⁵

After-tax profits as a percentage of stockholder equity in the steel **industry were** below that for all manufacturing (often by a substantial margin) in every year since 1957, except during the severe recession of **1974**. In fact, for most of the 1970's the after-tax rate of return on stockholder equity in the steel industry was below the prime lending rate (quite the reverse of the 1950's and 1960's).⁶

Capital Investment

High inflation and high interest rates during the 1970's contributed to: 1) slowing the overall investment in the steel industry, 2) reducing the ability of the industry to borrow funds to make

⁵ *Technology and Steel Industry Competitiveness*, ch. 4, op. cit., pp. 119-124.
⁶ 1&j.

long-term investments at a time when firms were becoming more dependent on external financing of investments (because of low profit levels), 3) discouraging long-term investment (because of increased uncertainty about economic conditions), and 4) decreasing growth prospects for the U.S. steel industry. *

As shown in figure 33, steel industry capital investment increased substantially between **1972 and 1975; the level more than doubled even if the figures are discounted** for inflation. However, after 1975, there has been a significant decline in investment in terms of both current and constant 1972 dollars. This decline shows no sign of reversing itself.

One consequence of declining profitability of steel production in the United States during the 1970's was the shift from internal to external

*Steel production in the United States is on a long-term downward trend as measured by the ratio of steel produced to GNP. OTA analysis indicates that the most optimistic forecast for steel through the 1990's would have production well within current production capacity.

financing of capital investment. While capital expenditures in the steel industry increased from an average value of \$1.46 billion for the 1970-73 period to \$2.79 billion for the 1975-78 period, capital expenditures as a percentage of net internally generated funds increased from an average value of 78.2 percent for the 1970-74 period to 142.1 percent for the 1975-78 period. In addition, there was a perceptible increase in the debt-equity ratio, from 39.7 percent in 1971 to 49 percent in 1980.⁷

As in other industries, accelerating inflation and economic instability encouraged a slow drift away from long-term financing to short-term financing of investments as interest rates increased and real rates of return diminished, and away from less liquid long-term asset holdings to more liquid, short-term asset holdings. That kind of shift toward the short end on both the asset and liability side—although rational, given general economic conditions—reflected the decreasing abili-

⁷*Technology and Steel Industry Competitiveness, op. cit.*

Figure 33.—U.S. Capital investment in Steel industry, 1971=82

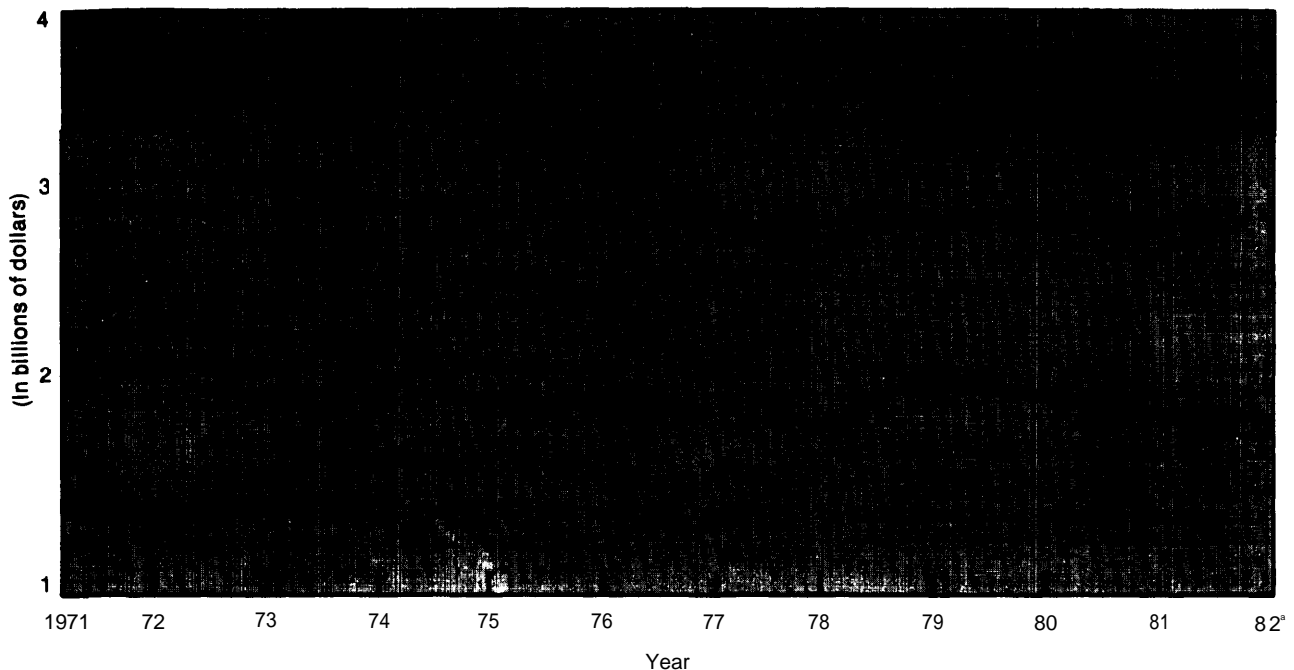

*Estimated.

SOURCE: Office of Technology Assessment.

ty of the steel industry to finance the kind of long-term, fixed capital investments necessary for preserving or enhancing the competitive position of U.S. steel producers in the domestic and foreign markets.

Furthermore, despite the availability of accelerated depreciation throughout the period 1954-79, inflation increased sufficiently to erode the capital purchasing power of depreciation allowances. Between 1954 and 1961, the purchasing power of depreciation allowances declined a modest 4.3 percent relative to the construction price index, and 2.8 percent relative to the GNP deflator. As inflation accelerated during the 1962-74 **period, the capital purchasing** power of recovered depreciation allowances declined 35.1 percent relative to the construction price index, and 15.2 percent relative to the GNP deflator.

Without analyzing specific expenditures it is impossible to determine to what extent capital investments for pollution control improved yields and lowered material or energy costs. Obviously, such gains would have diminished the net cost of pollution control investments. Nonetheless, these investments did place an additional strain on the steel industry's ability to invest in productive capacity and technological improvements. pollution control expenditures increased from **\$448.4 million** for the period 1951-65 (\$29.9 million per year), to \$572.8 million for the period 1966-70 (\$14.56 million per year), to \$1,229.9 million for the period 1971-75 (\$246 million per year), to \$2,643.3 million for the period 1976-80 (\$528.7 million per year).⁸

Finally, to gain a broader economic perspective, it is appropriate to compare U.S. steel investment figures with those of the energy industries. U.S. petroleum and gas companies invested about \$76 billion in 1980.⁹ The highest projected capital investment requirement for maintaining the U.S. steel industry in a competitive position during the 1980's is \$7 billion per year.¹⁰

⁸American Iron and Steel Institute, *Annual Statistical Report for 1980, 1981*, p. 10.

⁹*Oil and Gas Journal*, "Spending Plans by U.S. Firms 9.5% Less Than Outlay in 1982," Feb. 28, 1983, p. 40.

¹⁰American Iron and Steel Institute, *Steel at the Cross Roads: The American Steel Industry in the 1980s*, chs. III and VII, 1980.

Employment

In 1976, Pennsylvania, Ohio, Indiana, Illinois, and Michigan accounted for 72.4 percent of raw steel production out of a total of 128 million net tons. By 1980, they accounted for only 68.2 percent of raw steel production out of a total national production of 111.8 million net tons.¹¹ The decline in the share of these five States in total raw steel production corresponds to their disproportionate share of the decline in total employment in the steel industry—from 674,872 in 1974 to 568,958 in 1980 (or 15.7 percent). The visible consequences of decreased steel production and employment, when concentrated in specific communities, are more difficult to dismiss as market adjustment **processes**.

Employment trends cannot be understood without some reference to employment costs. During the period 1971-80, in which U.S. employment in steel production declined substantially, total employment costs per hour rose from \$6.261 per hour to \$18.451 per hour (about 13 percent per year).¹² As a benchmark, the **rate of inflation** in the consumer price index during the 1970's was approximately 8 percent per year. In short, employee compensation in the steel industry increased at a rate about 50 percent greater than the annual rate of inflation. The Council on Wage and Price Stability report in 1977 indicated that during the period 1952-77, total hourly costs increased 450 percent for steel production, compared to an increase of 297 percent for all manufacturing workers.¹³

Production Costs

The costs of producing plain carbon steel products vary markedly between companies and plants, depending strongly on the product mix and particular requirements and costs of raw materials and energy. Furthermore, the costs are substantially higher for the integrated steel companies than for scrap-based mini mill companies. *

¹¹American Iron and Steel Institute, *Annual Statistical Report for 1980*, p. 57.

¹²*ibid.*, p. 21.

¹³Council on Wage and Price Stability, *Report to the President on Prices and Costs in the U.S. Steel Industry, 1977*.

*Many financial experts have predicted that the scrap-based companies will account for 25 percent of domestic steel production by 1990. There is no technical barrier to such growth. Growth in excess of this rate will depend on the ability of the scrap-based companies to develop competitive quality in other product lines.

The following figures are broad average estimates of production costs for plain carbon steel products in integrated and scrap-based companies:

| Categories | Costs per ton of shipments | |
|----------------------------|----------------------------|-------------|
| | Integrated | Scrap based |
| Raw materials | \$105.00 | \$100.00 |
| Energy and fuels | 125.00 | 75.00 |
| Labor | 175.00 | 100.00 |
| Total | \$405.00 | \$275.00 |

At market prices of \$410 to \$500 per ton, only \$5 to \$95 per ton remain for capital costs in the integrated sector.*

Product Demand

One deterrent to capital investment in the steel industry during the late 1970's and early 1980's was the slackening of product demand, particularly in the construction and automobile industries. The downturn in steel shipments to the construction and auto industries between 1973 and 1980 accounted for nearly 60 percent of the 27.6-million-ton decline in U.S. steel shipments. To the extent that depressed conditions in both these sectors are likely to persist throughout the early 1980's, the short-term prospects for growth in U.S. steel production are likely to remain modest at best. On the other hand, it should be noted that between 1973 and 1980, steel shipments to the oil and gas industry increased 57.7 percent, from 3.4 million tons in 1973 to 5.4 million tons in 1980.¹⁴

The downturn in steel demand decreased capacity utilization rates, while utilization rates are always subject to measurement errors, the cycle in raw steel production capacity utilization rose from 80.9 percent in 1976 to 87.8 percent in 1979, and declined to 72.8 percent in 1980 and to 50 percent for the first 9 months of **1982**, as estimated by the American Iron and Steel Institute (AISI). AISI estimates that the current combined capacity utilization rate of the East Euro-

pean countries, Japan, and the United States has been below 60 percent for much longer. With projected rapid expansion of steel capacity in the developing countries to more than 100 million tons in 1985, the continued pressure on the East European, Japanese, and U.S. steel mills is evident.

Imports and Exports

The U.S. average share of world raw steel production has declined from 60.1 percent in the post-war 1940's to 45 percent in the 1950's, 32 percent in the 1960's, and 25 percent in the 1970's. During this same period, imports as a percentage of apparent U.S. domestic steel supply—negligible during the first half of this century—rose from 0.24 percent in the 1940's to 15.5 percent in the 1970's. Imports represented approximately 20 percent of apparent domestic steel supply in 1981 and 25 percent by the second quarter of 1982.¹⁵

The primary source of competition for U.S. steel sales in the U.S. market has come from Japan, whose production costs are about **20** percent lower. The U.S. Council on Wage and Price Stability compared production costs in dollars per net ton of finished steel products, assuming the U.S. product mix for 1976. The two primary sources of the Japanese cost advantage were associated with higher U.S. labor costs (\$100.24 per ton in the United States, compared to \$60.48 per ton in Japan) and the lower yield in converting raw steel into finished steel in the United States compared to that in Japan (0.710 and 0.75, respectively).¹⁶

Focusing more directly on labor costs and labor productivity, it is clear that among major competitors only Japan has maintained a substantial advantage relative to the United States. The productivity of a dollar spent on labor in steel production in Japan was more than three times as great as that in the United States in 1964 and more than twice as great in 1975.

*These estimates do not apply to periods of abnormally low demand such as the industry experienced during the second quarter of 1982. During these times, cost per ton can be much higher since large fixed costs must be spread over fewer units of product.

¹⁴American Iron and Steel Institute, *Annual Statistical Report for 1980*, pp. 30-33.

¹⁵American Iron and Steel Institute, *Annual Statistical Report for 1981* (May 1982) and 1982 (unpublished).

¹⁶Council on Wage and Price Stability, *Report to the President on Prices and Costs in the U.S. Steel Industry, 1977; Technology and Steel Industry Competitiveness*, ch. 4, op. cit.

For the period 1957-75, the hourly labor costs rose more rapidly in West Germany, France, and Japan than they did in the United States. For example, hourly employment costs in steel production in Japan rose 806 percent, from \$0.65 in 1957 to \$5.89 in 1975. From 1964 to 1975, output per man hour increased 167 percent (from \$3.51 to \$9.35) in Japan, yet only 17.5 percent (from \$6.92 to \$8.13) in the United States .17

The more rapid rise in hourly employment costs in Japan and West Germany helps explain the decline in the index of output **per dollar spent**

on labor in Japan relative to that in the United States—from 3.22 in 1964 to 2.58 in 1975—and the decline in the index of output per dollar spent on labor in West Germany relative to that in the United States—from 1.55 in 1964 to 1.09 in 1975. If the U.S. steel industry continues to modernize its capital equipment and to diminish the share of non production employees in the work force, the comparative advantage of these foreign producers in output per dollar spent on labor will continue to decline. However, the United States may still face stiff competition from developing nations such as Brazil and Korea, where plant and equipment are very modern and wage rates are very low.

ENERGY AND TECHNOLOGY

Production Processes

Energy is consumed in steel production during the processes of six major stages: preparation of raw materials, ironmaking, steel making, primary finishing, secondary finishing, and heat treating. Table 51 lists major process technologies for each stage of production and figure 34 combines them in a flow chart.

Table 51.—Energy Services and Major Processes in the Iron and Steel Industry

| Energy service | Major processes |
|------------------------------|-----------------------------------------------------------------------------------------------------------------------------------|
| Beneficiation | Sintering Pelletizing |
| Coking | Byproduct coke oven/wet quench Byproduct coke oven/dry quench Formcoking |
| Ironmaking | Blast furnace Blast furnace with hydrogen injection Direct reduction—gas Direct reduction—coal |
| Steelmaking Basic | oxygen furnace Electric arc furnace Open hearth furnace |
| Primary finishing | Ingot casting/soaking/breakdown mill Continuous casting Ladle preheating |
| Secondary finishing. | Batch reheating/rolling Continuous reheating/rolling Electric induction reheating/rolling Direct rolling Cold rolling |
| Heat treating | Direct tube furnace Radiant tube furnace Electric furnace |

SOURCE Off Ice of Technology Assessment

Preparing Raw Materials

Iron ore, coal, and limestone are the raw materials of making steel. After preparation, they are combined in a blast furnace, where the iron ore is smelted to metallic ore. Coal, which is first converted to coke, supplies the carbon necessary for generating the terrific heat and reducing gases necessary for smelting. Limestone is used to combine with the impurities in the molten iron to form slag, which floats atop the liquid and can be removed.

During materials preparation, two processes are particularly energy intensive.

Beneficiation of Iron Ore.—Through several processes known generally as beneficiation, iron ore chunks are first crushed and ground, then refined. They are then agglomerated, that is, sintered (heated to form a mass) and formed into marble-sized pellets. The agglomeration processes are particularly energy-intensive,

Coking.—The reduction of iron ore to metallic iron is most economically accomplished by carbon. In modern ironmaking, the source of carbon is coke, a solid, relatively nonvolatile product, about 90 percent pure carbon, that remains when coal is heated at 1,650° to 2,000° F for 12 to 18 hours to boil off its volatile components.

Figure 34.—Process Flows in the Iron and Steel Industry

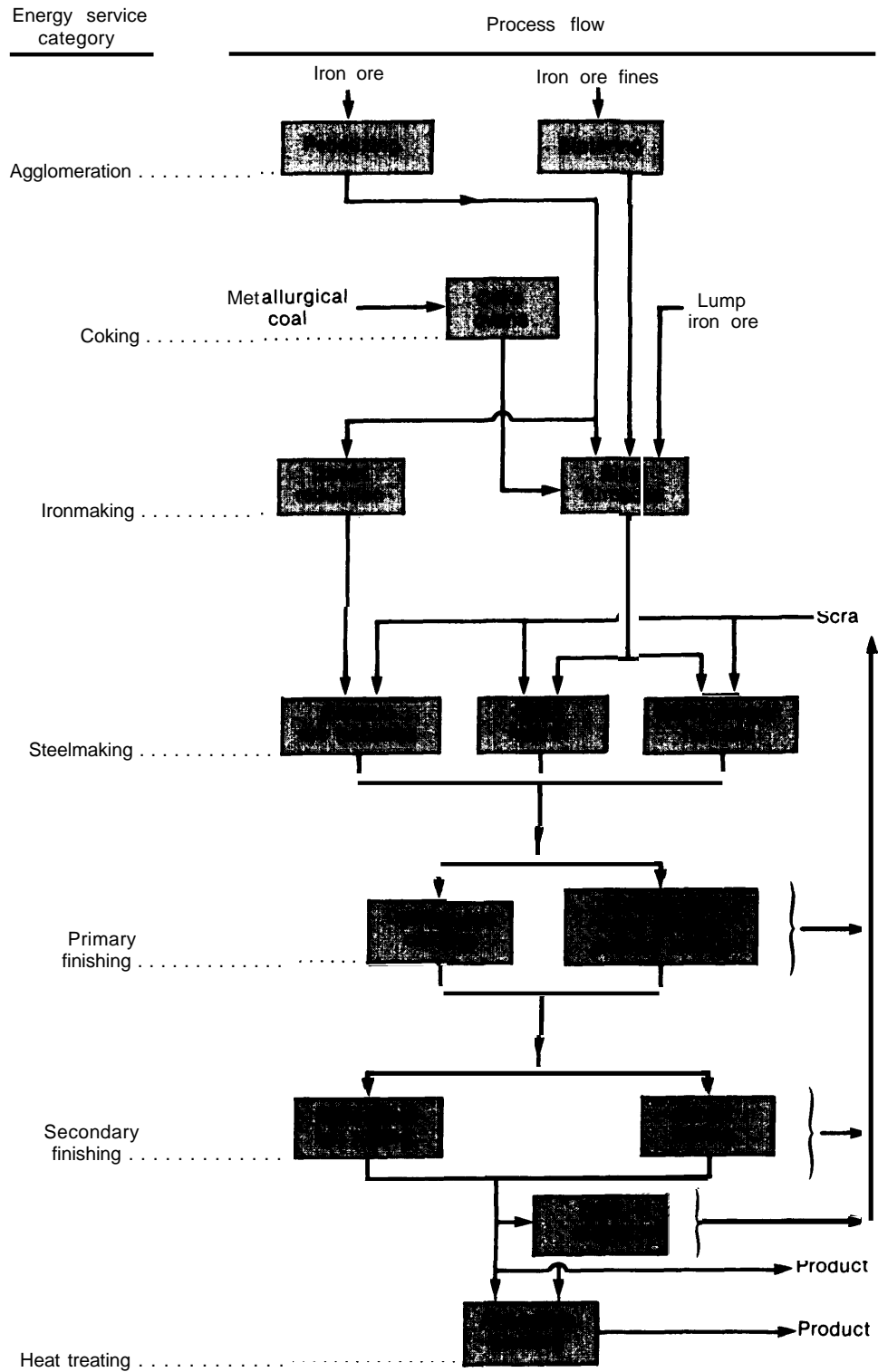

SOURCE: Energy Productivity Center, Mellon Institute, *Final Report on Industrial Energy Productivity Project, Volume 4, The Iron and Steel Industry*, September 1982.

There are two proven processes for manufacturing coke, the beehive oven and the byproduct (slot) oven; although in the United States the byproduct process is used almost exclusively. In the byproduct process, coal is heated in chambers in the absence of air by the external combustion of fuel.

Ironmaking

Iron ore must be first transformed to metallic iron by the reduction of the iron oxides in the blast furnace—the conventional, and only, technology existing in the United States today to produce iron. To make iron, iron-bearing materials (iron ore, sinter, pellets, mill scale, slag, iron or steel scrap, and the like), fuel (coke), and flux (limestone and/or dolomite) are charged into the top of the blast furnace. Heated air (blast) and, in some instances, fuel (gas, oil, or pulverized coal) are blown in at the bottom. The hot air blast burns the coke to heat, reduce, and melt the charge as it descends through the furnace. The liquid iron and slag that collect in the furnace are tapped at regular intervals through separate tap holes.

Blast furnace capacities vary from 1,000 to 10,000 tons per day of hot metal. The industry trend is toward large furnaces. The two most recently built blast furnaces have a production capability in the range of 8,000 to 10,000 tons per day.

Steelmaking

Steelmaking is a refinement process whereby undesirable amounts of other chemical elements, such as carbon, manganese, phosphorus, sulfur, and silicon are reduced and removed from the pig iron, and small quantities of other elements (fluxes and alloying materials) are added to produce desired steel properties.

Steel is made in three types of furnaces—the basic oxygen furnace, the electric arc furnace, and the open hearth furnace. All three processes are used to produce carbon steel. Stainless steel is limited to basic oxygen furnaces and electric arc furnaces; the latter are also used to produce special alloys from select scrap feedstocks.

Now the leading and fastest steel making process, the basic oxygen furnace refines steel (in about 32 minutes per batch) by blowing oxygen into the furnace, producing an intense chemical reaction in the charge of scrap, molten iron, and lime. The basic oxygen process produced 61 percent of the Nation's raw steel in 1979.

The electric arc furnace refines molten iron and produces steel by electric arcing between three carbon electrodes and the scrap iron charge. In 1980, such furnaces produced 27 percent of the Nation's raw steel.

The open hearth furnace is charged by scrap limestone, and iron, followed by molten iron. Oxygen and natural gas, fed into the bath, produce the temperatures necessary to refine the mixture into steel. The open hearth process, which dominated steelmaking in the United States for many years, has steadily lost ground. Production in open hearth furnaces declined from 85 million tons (64 percent) in 1966 to 13 million tons (12 percent) in 1980.

Primary Finishing

Primary finishing includes the operations of casting—pouring liquid steel into its first solid form (raw steel)—and then converting the raw steel to semifinished shapes such as slabs, blooms, and billets. There are two casting techniques, ingot and continuous.

In ingot casting, the conventional casting method, liquid steel is tapped into a refractory-lined, open-topped vessel called a ladle. The ladle is moved by an overhead crane to a pouring platform where the steel is then poured or "teemed" into a series of molds. The steel solidifies in each of the molds to form a casting called an "in got." Subsequently, the molds are removed, and the stripped, cooling ingots are placed in a soaking pit, where they are reheated to an even temperature for rolling (shaping). After soaking, the molds are transported to mills for rolling into blooms (rectangular forms) and billets (square forms) for use in structural shapes and bars, and slabs, for use in all flat-rolled steel.

Continuous casting is a newer process in which liquid steel is directly cast into the desired semi-

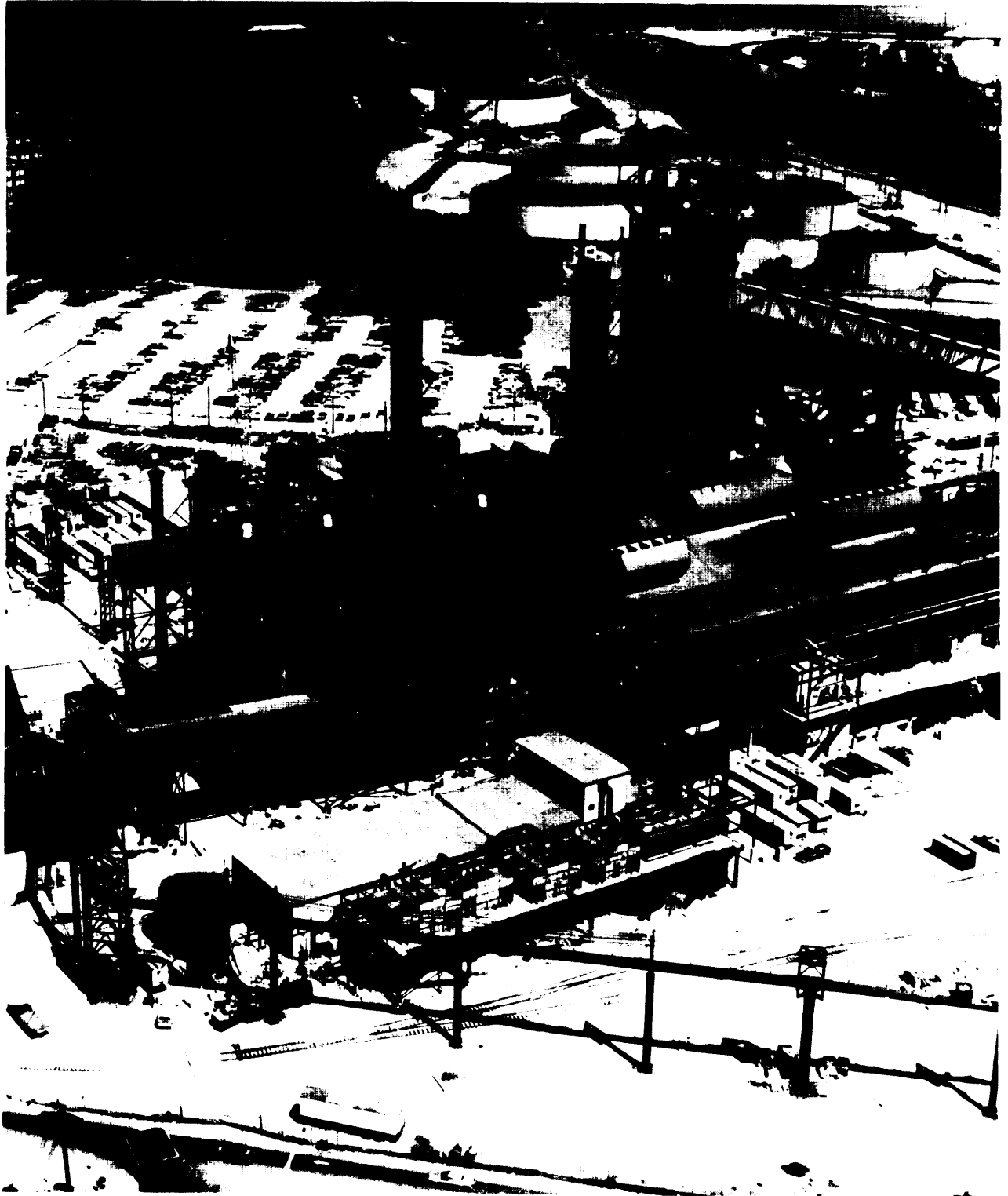

Photo credit: American Iron and Steel Institute

Blast furnace complex

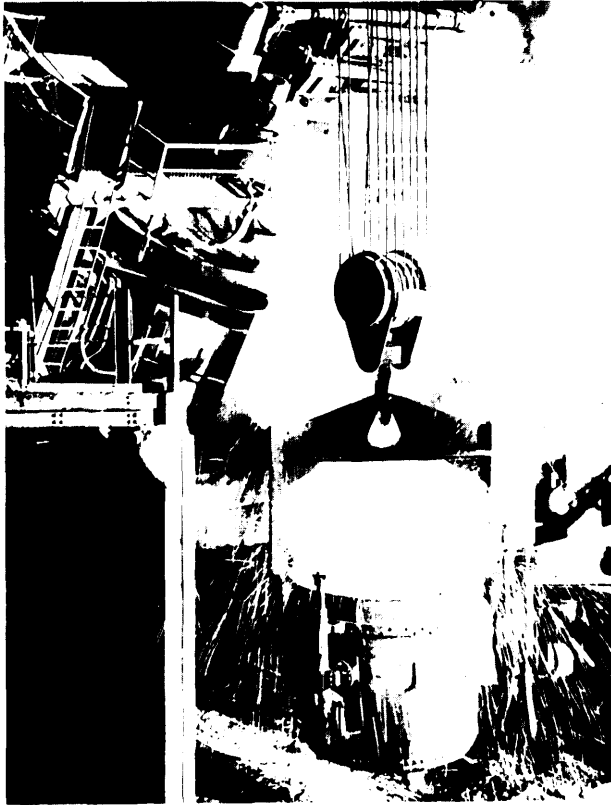

Photo credit: American Iron and Steel Institute

Steel from the electric furnace is being poured into ladle for processing in the continuous caster

finished shape, thus eliminating the intermediate steps of ingot casting and reheating, and lowering the energy **per final ton of product**. **Figure 35 shows a cross-section of a typical caster.**

Secondary Finishing

Secondary finishing includes the operations of reheating the slabs, blooms, and billets produced **in primary finishing and transforming them through hot and cold rolling steps into final products.** **Reheat furnaces** are used to heat steel shapes to temperatures of 2,300° to 2,400° F prior to rolling operations. Such furnaces can be classified into two types—batch and continuous—based on their mode of operation. Fossil fuels are the usual energy sources in these furnaces, but electric furnaces are also used.

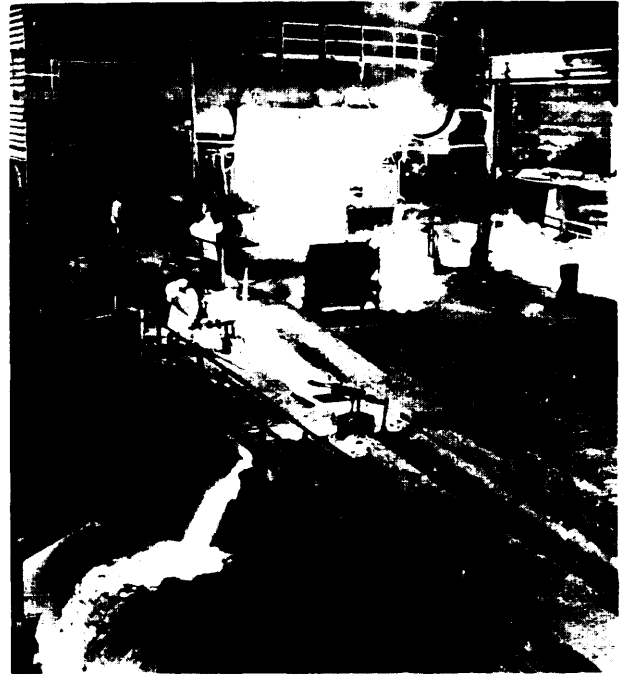

Photo credit: American Iron and Steel Institute

Molten iron is being tapped and taken away from the blast furnace for further processing into steel

Heat Treating

The final step in the finishing operations is heat treating. Cold-working steel results in a highly stressed product with low ductility. The principal purposes of heat treating are to relieve these stresses, obtain full recrystallization to a more uniform grain structure, and improve ductility to a level suitable for forming operations. This goal is accomplished by heating the steel to a specified temperature at which it is held for some time (soaking), followed by gradual cooling. The most common heat treatments performed are annealing, normalizing, spheroidizing, hardening, tempering, carburizing, and stress relieving. Of these, annealing is done on the largest scale within the U.S. steel industry.

Energy Use

All of the stages of steel production use energy to alter the chemical composition of the metal

Figure 35.—Cross-Section of a Typical Continuous Casting Machine

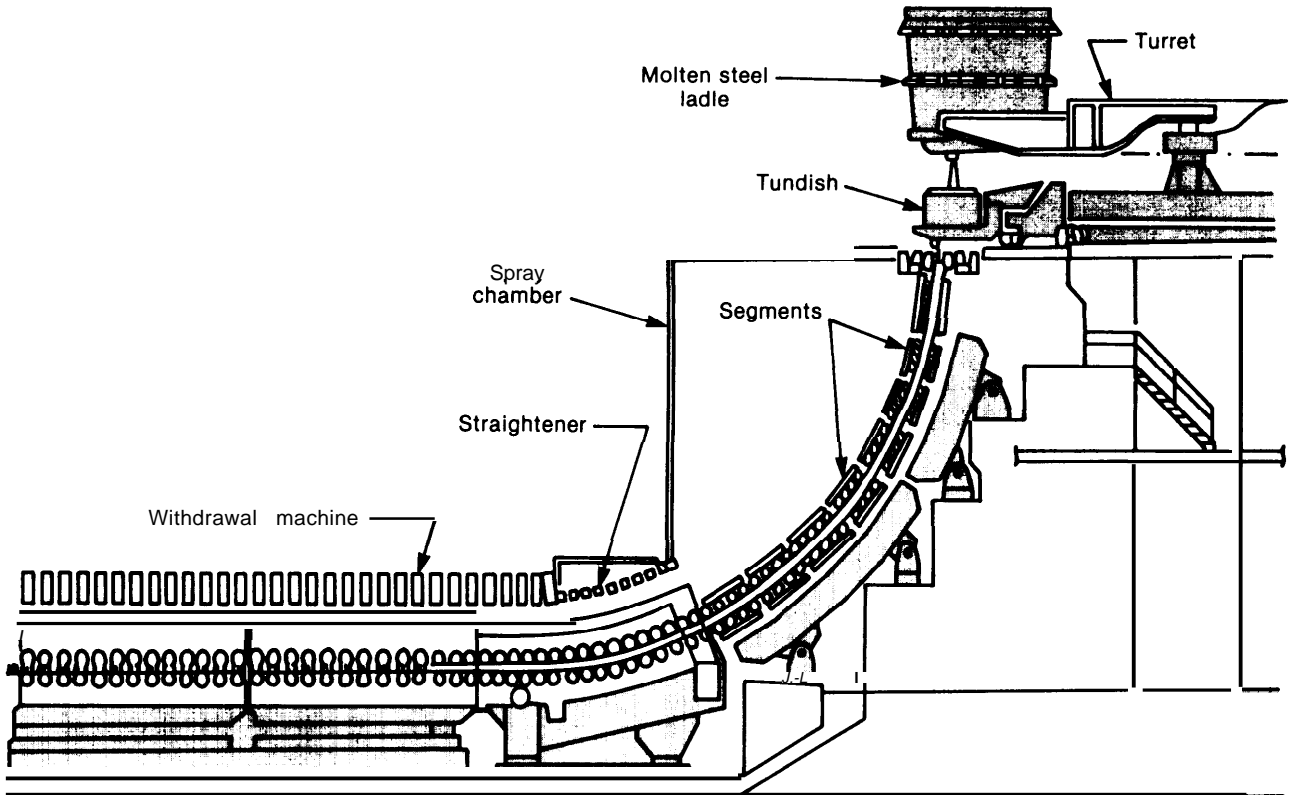

SOURCE: American Iron and Steel Institute, 1976

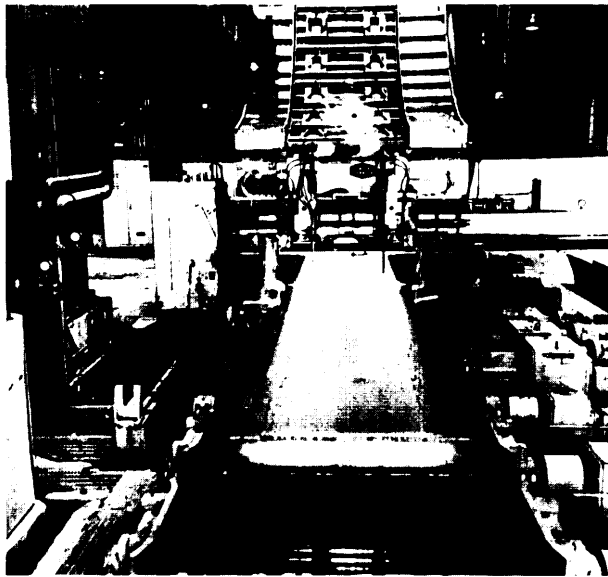

Photo credit: American Iron and Steel Institute

The slab is being torch cut after emerging from the continuous slab caster

or to work the metal into useful forms and shapes. Every plant and company has its own unique mix of process efficiencies, for a variety of reasons such as the age of the plant, the design of equipment, and the mix of products. As an illustration, the mix of primary and byproduct fuels for one major integrated steelmaker is presented in figure 36.

Under the most ideal circumstances, the energy required to produce solid iron from iron oxide can never be less than 7 million Btu per ton (MMBtu/ton). Since the energy required to melt iron under the most ideal circumstances is about 1 MMBtu/ton, the inherent thermodynamic advantage of making liquid steel from scrap rather than from iron ore is about 6 MMBtu/ton. When process heat losses are included, the advantage falls in the range of 9 to 14 MMBtu/ton. *

*These estimates include the energy value of coal at the power generator—i.e., a conversion factor of 10,494 Btu/kWh has been applied.

Figure 36.— Energy Consumption by Production Process in a Typical Integrated U.S. Steelmaker

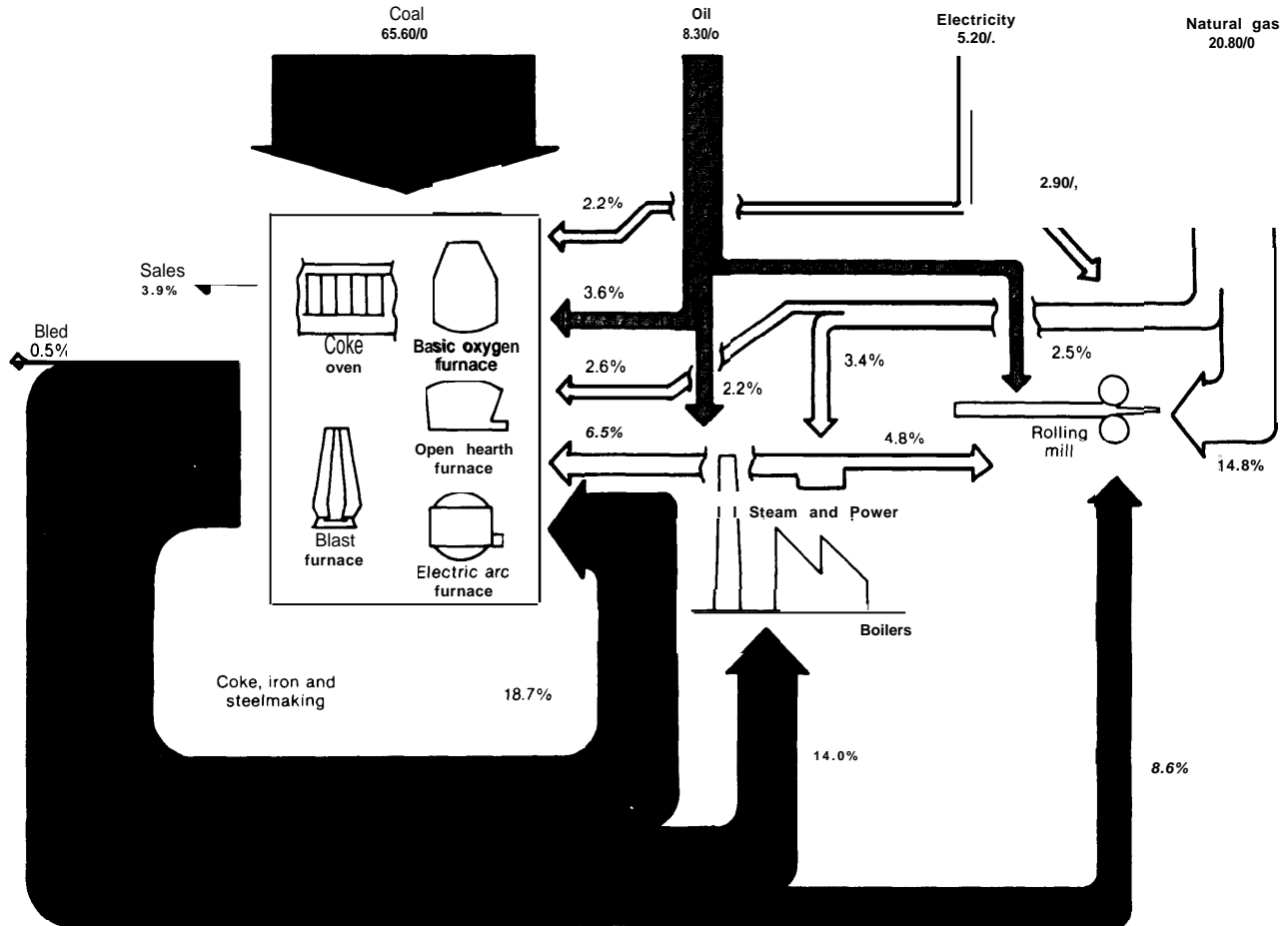

SOURCE Off Ice of Technology Assessment

current total energy requirements for the production of finished steel products in different plants and countries from iron ore range from 25 to 35 MMBtu/net ton. A review of alternative energy sources used in steel production, along with relative shares for the period 1972-80 leads to several points worth noting. First, coking coal, steam coal, and purchased coke consistently provide nearly two-thirds of the energy used in U.S. steel production (see table 52). Natural gas accounts for about 25 percent; petroleum, less than 5 percent; and purchased electricity, which has **risen significantly in recent years, about 7** percent. The increase in electricity is due primarily to increased use of the electric arc furnace. Electricity in this case is generated to a great extent by coal or nuclear fuel.

Petroleum provides only a small amount of **energy**, although the substitution of petroleum and natural gas for coal and other energy sources frequently results in net total energy savings in iron-making and steel making. For example, total energy requirements in the iron blast furnace can be reduced by the injection of oil or gas in the blast, and total energy requirements in the steel-making electric arc furnace can be reduced by in situ heating of scrap with oxyhydrocarbon burners,

A summary of fuel use, scrap use, and process use during the period 1976-80 is presented in table 52. The data are normalized on the basis of tons of shipments. Several important trends are evident. With the addition of continuous casting

Table 52.—Fuel Use and Energy. Related Trends in the Steel Industry

| Fuel use per ton of steel shipments (10° Btu) ^a | 1976 | 1977 | 1978 | 1979 | 1980 | 1981 |
|-------------------------------------------------------------------|--------------|--------------|--------------|--------------|--------------|--------------|
| Coal, coke | 22.4 | 20.0 | 17.2 | 17.9 | 18.2 | 16.0 |
| Coal, steam | | | 0.8 | 0.8 | 0.8 | 0.8 |
| Natural gas | | | 6.7 | 6.2 | 6.1 | 6.4 |
| Purchased coke | | | 1.7 | 1.2 | 1.7 | 1.9 |
| Fuel oil | | | 2.7 | 2.8 | 2.9 | 2.1 |
| Liquefied petroleum as Purchased electricity | | | 0.7 | 1.0 | 0.6 | 0.3 |
| Totals, 10° Btu | 36.5 | 33.7 | 30.9 | 31.2 | 30.0 | 27.8 |
| Cost,^c 1982 dollars | 128.4 | 120.6 | 113.7 | 114.0 | 109.4 | 105.6 |
| Recent trends— | | | | | | |
| Shipments, 10 ⁶ tons | 89.4 | 91.1 | 97.9 | 100.3 | 83.9 | 87.0 |
| Raw steel, 10° tons | 128.0 | 125.3 | 137.0 | 136.3 | 111.8 | 119.9 |
| Yield, % | 69.8 | 72.9 | 71.5 | 73.6 | 75.0 | 72.6 |
| Continuous cast, % | 10.6 | 12.5 | 15.2 | 16.9 | 20.3 | 21.1 |
| % of raw steel: | | | | | | |
| Open hearth | 18.3 | 16.0 | 15.6 | 14.0 | 11.7 | 11.2 |
| Basic oxygen process | 62.5 | 61.8 | 60.9 | 61.1 | 60.4 | 61.1 |
| Electric arc furnace | 19.2 | 22.2 | 23.5 | 24.9 | 27.9 | 27.7 |
| Total purchased scrap, % | 36.0 | 40.0 | 40.0 | 43.0 | 48.0 | |

^aBased on preventative calorific values.^bAssuming 3,412 Btu/kWh.^c1982 average prices applied to yearly figures.^dShipments divided by raw liquid steel. The decline in 1981 is an artifact of a sharp increase in inventory.^ePercent of total metallic feedstocks.

SOURCE: American Iron and Steel Institute and the Office of Technology Assessment.

equipment the yield of steel shipments from raw **liquid steel** has increased at a steady rate. The **increasing** role of electric arc furnaces has brought about a concomitant increase in the use of scrap for steel production. While the use of coal and petroleum products has declined over the last 5 years, the use of natural gas per ton of shipped steel has remained relatively constant. These and other trends and their significance in assessing the possible impacts of legislative options are discussed in the following sections.

Energy Conservation

Steelmaking has a number of investment opportunities to save energy or to switch to lower cost fuels, and many have been exploited in the past decade. A comparison of energy and production data indicates that almost 17 percent less energy was used per ton of product in 1981 compared to 1972 (see table 53 and fig. 37). Most of the investments that have brought about this energy reduction can be described in terms of specific technologies, but some save energy as an incidental benefit of any modernization that

shortens times for processing and handling of hot metals. A sample of these opportunities is summarized in table 54.

While there are many energy-saving technologies, the substitution in the last 5 years of continuous casting for ingot casting and the displacement of the basic oxygen furnace or open hearth furnace by the electric arc furnace are pivotal for economic as well as energy efficiency reasons. In fact, analysis of 1976 and 1980 data shows that actual reductions in energy per ton of steel shipments can be almost entirely explained by the increased use of continuous casting and the melting of scrap in electric arc furnaces. *

Electric Arc Furnace

Electric arc furnace (EAF) technology saves energy by allowing the substitution of scrap metal for iron ore. Expansion of scrap-based production has been encouraged recently by relatively low scrap prices, leading to a cost advantage of

*This analysis is contained in a separate contractor report.

Table 53.—Comparison of 1981 and 1972 Energy Consumption for U.S. Steel Companies

| | For corporations using 1972 as the reference year | |
|------------------------------------------|---------------------------------------------------|---------------------------------|
| | 1981 consumption (trillion Btu) | 1972 consumption (trillion Btu) |
| Bituminous coal ^{a,c} | 1,144 | 1,944 |
| Metallurgical | 1,082 | 1,854 |
| Boiler | 60 | 83 |
| Other | 2 | 7 |
| Anthracite coal | 3 | — |
| Coke (purchased) | 182 | 110 |
| Coke oven gas (purchased) | 2 | 4 |
| Tar or pitch (purchased) | 3 | 1 |
| Total coal | 1,335 | 2,059 |
| Natural gas | 508 | 667 |
| Distillate fuel oil | 9 | 13 |
| Residual fuel oil | 81 | 187 |
| Gasoline | 1 | — |
| Other petroleum products | 4 | 1 |
| Propane | — | 1 |
| Other liquefied petroleum gas | — | 1 |
| Total petroleum | 96 | 204 |
| Electricity | 119 | 125 |
| Purchased steam | 1 | — |
| Total energy consumptions | 2,059 | 3,055 |

^aAll consumption figures shown are net of sales, inventory changes, and excluded usage. Due to historical data collection

procedures for individual fuels, some grouping of particular fuels occurs.

^bBituminous coal may include a small amount of anthracite coal.

^cEnergy content of coal byproduct sold is not included in this figure (i.e., subtracted from the gross figure).

^dOther petroleum products may include some gasoline.

^ePropane consumption may include a small amount of other liquefied petroleum gases.

SOURCE: American Iron and Steel Institute, data for 51 companies operating in 1961.

Figure 37.—Comparison of Steel Industry Energy Use and Production Output, 1972 and 1981

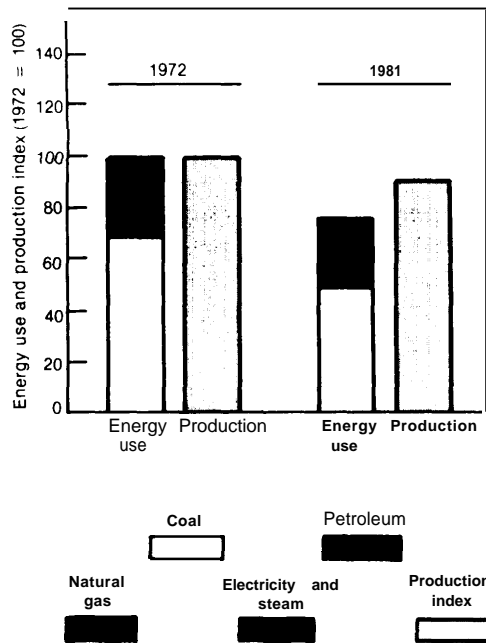

SOURCE: American Iron and Steel Institute

over \$125 per ton of shipments. Furthermore, if total demand for steel products remains steady or grows very slowly, supplies of scrap should continue to balance demand and thus hold scrap prices at favorable levels for steelmaker. This expectation is reinforced by growing supplies of directly reduced iron (DRI) from nations that have inexpensive supplies of natural gas or electricity. DRI is an excellent EAF feedstock because it is free of trace elements that contaminate scrap; therefore, mixtures of DRI and scrap may be used in the future to produce higher quality steel products.

Continuous Caster

Continuous casting is more energy efficient than ingot casting for two reasons. First, the use of continuous casting eliminates the need for ingot stripping, reheating, and primary rolling. Second, the yield of slabs and billets from continuous casting is much greater than that from ingot casting because less metal must be returned to the

Table 54.-Technologies for Improving Energy Efficiency in the Steel Industry

| Investment option | Energy efficiency-improving characteristics |
|---------------------------------------------|--------------------------------------------------------------------------------------------------------------------------------------|
| Dry-quenching of coke | Recovers waste heat of hot coke from ovens; saves coke; reduces environmental pollution because coke is quenched in a closed system. |
| Coke-oven gas desulfurization | Natural gas substitute. Some loss of calorific value, but improved product quality. |
| Blast furnace top gas turbine | Recovers waste energy by cogeneration. Only possible with the best high-pressure furnaces. |
| External desulfurization of hot metal | Saves coke by allowing lower slag volume and hot metal temperature in the blast furnace. Some energy used in desulfurization. |
| High-pressure blast furnace | Lowers coke consumption. |
| Electric arc furnace (EAF) | Allows for increased use of scrap, thereby lowering overall energy requirements for steel production. |
| Water-cooled panels, EAF | Allows for higher productivity and net energy savings in melting when refractory consumption is considered. |
| Oxy-fuel burners, EAF | Saves electrical energy and reduces melting time. Total energy consumption may be increased. |
| Open hearth, shrouded, fuel-oxygen lances | Reduces fuel requirements in the open hearth. May prolong useful life of open hearth. |
| BOF gas collection | Recovers calorific value of carbon monoxide with net energy savings. |
| Scrap preheating, BOF | Allows for greater use of scrap, thereby saving energy in ironmaking. |
| Secondary, ladle refining, EAF (e.g., AOD) | Saves electrical energy by removing refining function from EAF. |
| Closed system ladle preheating | Saves natural gas used for preheating ladles. |
| Continuous casting | Increases yield, thereby decreasing overall energy requirements; saves fuel gas in ingot reheating. |
| Continuous slab reheaters | Saves clean fuel gas through increased efficiency. |
| Continuous annealing and reheating systems | Saves clean fuel gas through increased efficiency. |
| Direct rolling | Saves clean fuel gas through the elimination of slab reheating. |
| Indication heating of slabs/coils | Allows fuel switching to electricity, conserves total energy, and increases yield. |
| Steam-coal injection into the blast furnace | Allows fuel switching from more expensive gas or oil. Technology should be available in 5 years. |

SOURCE: Office of Technology Assessment.

steelmaking processes in the form of waste and unfilled ingot molds. Specifically, the use of continuous casting represents a saving of about 2 MMBtu/ton in clean gaseous fuels used in reheating and about 2.5 MMBtu/ton in the general plant fuel mix from increased yield.

In 1981, 21.1 percent of U.S. steel was continuously cast. For comparison, continuous casting percentages of East European countries and Japan in 1980 were 39.2 and 59.5, respectively. If U.S. industry could invest in continuous casting equipment to raise its percentage to 60 percent, about 5 MMBtu/ton of shipments could be saved without any other changes,

Although all of the technological options have been demonstrated in domestic plants, not all of

them will be competitive investments in every situation. Many of these options require retrofitting existing equipment. In some instances, older equipment cannot be modified at a reasonable cost to take advantage of the opportunity. Sometimes physical plant layout prevents adoption of a specific technology.

In addition, it should be noted that new technologies often result in benefits that are difficult to evaluate. For example, besides saving energy, continuous casting and improved reheating facilities improve steel quality as well as reduce environmental problems.

INVESTMENT CHOICES FOR THE STEEL INDUSTRY

Investment Strategy

Firms that have traditionally been in the steel business are not really in business to make steel, but to make profits. The two objectives—profits and steel—are not necessarily in conflict, as demonstrated by mini mills, but for a broad cross section of major integrated and specialty steel producers, profitability in steel appears to be a distant future goal. Certainly, given the recent capacity utilization rates under 50 percent and the long downward trend for domestic steel production, the steel industry is not a strong magnet for new investments.

With the exception of mini mills, which use scrap metal feedstocks instead of iron ore and coke, existing steel firms are now deciding whether to invest more in steel or not; if they do, large investments are required just to match their foreign and domestic competition. Profits can still be made, but current low operating rates make investment difficult because they severely limit internal funds. Attempts to raise outside capital can lower credit ratings and sharply discount stock values. In these circumstances, many existing firms are forced into triage, writing off their least competitive shops in order to keep their best capacity on line.

Negative investment prospects would turn around if general economic activity were to pick up sharply. When industry experts were asked to comment on the impacts of the four policy options analyzed by OTA, they generally couched their responses in terms of the need for product demand to increase, followed by concern about high interest rates as they affect both product market demand (i.e., steel-intensive products are often investment goods) and the cost of borrowing for steel industry investments. High interest rates reduce the leverage of all four policy options by making it more difficult to achieve efficient capacity configuration. Both of these general economic concerns, the depressed GNP and high interest rates, were often raised to suggest that the steel industry's present **use of energy was justified by existing product and factor markets.**

Closely following is a third broad economic issue—steel imports. Among integrated and specialty steelmaker, there is the widespread belief that many exporting countries are unfairly subsidizing steel exports to the United States and that such imports have been a major reason why domestic capacity is below the 50 to 60 percent levels necessary for breaking even. Consequently, a large cross section of firms believes that restriction of steel imports is a top priority for Government action.

Appropriately, in an economy based on notions of free trade, steel industry proposals for import restriction are controversial. Critics question the steel industry's willingness and ability to meet legitimate foreign competition. They point out that research, development, and demonstration efforts have been minimal for several decades, despite the growing foreign competition. They also identify important inefficiencies in major integrated mills that can be traced to longstanding company and union policies, practical only when U.S. technology was preeminent. Finally, several major companies have recently demonstrated a clear lack of confidence in their ability to compete by abruptly closing down existing plants without replacement and by diversifying into nonsteel activities.

In addition to this general economic background, an energy-related discussion of steel industry investment should take into account the industry's legitimate strategic goals of overall cost minimization and product market growth. Within total costs or total cost per ton, energy (including coke) constitutes 25 to 30 percent, which is somewhat less than the cost share for labor and only somewhat larger than shares for materials and capital. Furthermore, by far the largest energy expenditure is for coal (on the average around 66 percent, excluding coal-fired electricity), which is the most abundant energy resource in the United States. If special attention for energy is justified, it must be primarily because natural gas (a premium fuel) accounts for about one-fourth of total steel energy.

In other words, energy investments must compete for scarce funds along with all other profitable technologies, and in order to examine energy impacts of Federal policy options, the full range of technical investment alternatives must be considered. Fortunately, as discussed above, this does not really stretch the analysis far from energy because the two primary energy-saving technologies, continuous casters (CC) and EAFs, are also two of the best investments to reduce total costs per ton of steel. In fact, CCs and EAFs are virtually mandatory investments for any firm wishing to modernize itself. Without continuous casting, low-product yields and quality, as well as high energy costs, diminish sales and profits. Similarly, without expanding EAF capacity to maximize scrap utilization to produce lower grade carbon steel products, a firm can have costs in excess of \$100 per ton higher than those of its competitors. Consequently, with significant opportunities remaining for both technologies in the United States, CC and EAF investments act as bellwethers for domestic steel. Investment in additional CC and EAF capacity amounts to a greater commitment to stay in the steel business and thus

to invest in other projects that improve product quality and reduce total costs.

Specific Energy-Related Investments

While the following policy analysis will focus on generic CC and EAF technology, there are many other energy investments that save energy and reduce energy costs to a lesser extent. Significant energy savings may also be achieved indirectly when large investments in product finishing **motivate complementary plant reconfiguration that reduce delays in product handling, and thus heat losses** in reheating (see table 54).

When all of these direct and indirect routes to energy saving are added together, they can save as much energy as the addition of CCs or an EAF. But project economics vary a great deal from plant to plant, making it difficult to describe generic projects. Several have been included along with the given CC and EAF in the illustrative internal rate-of-return (1 RR) calculations, but it is important to remember that all such calculations when applied to real investment planning are highly site-specific.

POLICY IMPACTS ON THE STEEL INDUSTRY

policy impacts on energy consumption by the steel industry are defined by comparison to a reference case projection that assumed no change in current policies, including the accelerated depreciation section of the Economic Recovery Tax Act of 1981 (ERTA). Safe harbor leasing provisions are not included in the projections made below, although the steel industry has been among the largest users of this opportunity to raise investment capital by reducing corporate income taxes.

The Reference Case

The steel industry is currently making investments that sharply lower production costs by increasing energy efficiency, among other improvements in **process efficiency and product quality. Besides investments in EAF and CC, significant savings in** energy costs are expected in the 1990's,

when technology will be available for substituting steam coal for natural gas and oil as hydrocarbon, which is injected directly into the blast furnace.

In this reference case, OTA assumed the fuel price growth rates, general economic growth rates, and steel industry growth rates shown in table 55. Figure 38 shows that OTA projects energy efficiency in the production of steel to decline from 31 MMBtu/ton of shipments to about 19 MMBtu/ton by 2000, an improvement predicated on slow but steady growth in shipments. This growth in demand for domestic products is important to assure the availability of investment funds, especially **for the large, integrated producers who in the fall of 1982 were operating well under .50 percent of their available capacity. If this growth in demand does not** occur, improvements in efficiency will occur more slowly, although total energy use may not

Table 55.—Historical and Projected Growth Rates for Production and Fuel Prices, 1976-2000

| | 1976-80 | 1980-85 | 1985-WI | 1990-2000 |
|----------------------------------------------------------|----------|-------------|-------------|-------------|
| All manufacturing FRB ^a growth rate | 3.25%/0 | 3.9% | 4.30/0 | 3.7%/0 |
| Iron and steel industry | -1.6 | | | 0.8 |
| Fuel price, gas(\$MMBtu) | — | 5.0 | 6.3 | 9.0 |
| Fuel price, residual (\$/MMBtu) | — | 5.0 | 6.2 | 9.0 |
| Fuel price, coal (\$/MMBtu) | — | 2.2 | 2.3 | 2.4 |
| Fuel price, electricity (\$/MMBtu) | — | 13.8 | 13.7 | 13.8 |

^aFederal Reserve Board.

SOURCE: Office of Technology Assessment

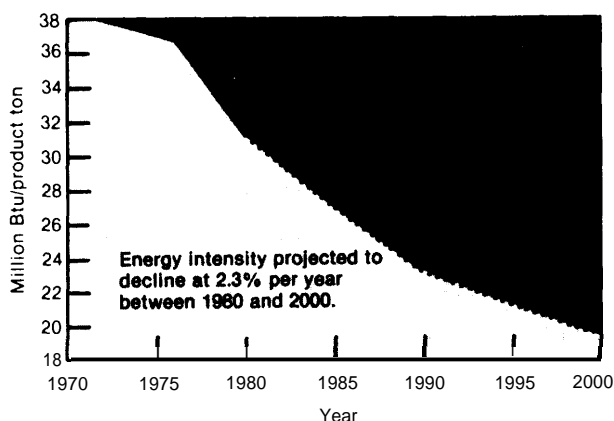
Figure 38.—Iron and Steel Industry Energy Intensity Projections, 1970-2000

SOURCE: Office of Technology Assessment

exceed projected levels because of the shutting down of older, fuel-inefficient capacity.

As part of this general, energy efficiency improvement, the reference projection calls for a steady decline in the use of both oil and gas, shown in table 56, as both premium fuels are displaced in reheating (of in-process ingots, slabs, and billets) and in blast furnace injection. Use of metallurgical coal is also expected to decline, primarily because of the displacement of hot iron from the blast furnace by melted scrap and by directly reduced iron from the EAF. There will also be major declines in the coke rate per ton of hot iron due to the direct injection of cheaper hydrocarbons (steam coal) into the blast furnace.

Table 56.—Fuel Use Summary: Reference Case, 1980-2000 (In trillion Btu)

| Total fuel Use | | | | | | | | | |
|-----------------------|-------------|--------------|----------------|--------------------|------------|-------------|-------------|---------------------|--|
| Year | Natural gas | Residual oil | Distillate oil | Metallurgical coal | Steam coal | Electricity | Other fuels | Total primary fuels | |
| 1980 | 448 | 175 | 33 | 1,675 | | 213 | 0.8 | 2,615 | |
| 1985 | 438 | 136 | 20 | 1,617 | :: | 244 | | 2,543 | |
| 1990 | 368 | 117 | 15 | 1,417 | 111 | 262 | 1.0 | 2,291 | |
| 2000 | 297 | 95 | 10 | 979 | 400 | 307 | 1.0 | 2,088 | |

| Fuel use as percent of total purchased fuels | | | | | | |
|-----------------------------------------------------|-----|-----|------------|--------------------|-------------|--|
| Year | Gas | Oil | Steam coal | Metallurgical coal | Electricity | |
| 1980 | 17 | 8 | | 64 | 8 | |
| 2000 | 15 | 3 | 20 | 47 | 15 | |

| Fuel use as percent of total purchased fuels minus metallurgical coal | | | | | |
|------------------------------------------------------------------------------|-----------|----------|------------|-------------|--|
| Year | Gas | Oil | Steam coal | Electricity | |
| 1980 | 43 | 20 | 7 | 20 | |
| 2000 | 27 | 6 | 38 | 29 | |

SOURCE: Office of Technology Assessment.

The reference case and policy impacts are also illustrated in terms of the profitability of generic investment options. Table 57 describes eight generic investments, along with economic and energy assumptions used to dollars. The profitability of each project is reflected in the calculated IRR on investment (see table 58).

Projected Effects of Policy Options

Option 1: Removal of Accelerated Depreciation

Like all capital-intensive industries, the steel industry welcomes policies that reduce the tax burden on income. Safe harbor leasing conferred exceptionally large benefits on the steel industry—

primary metals obtained the third largest share of leased property among two-digit SIC industries—because many modernization investments were well over due and because low profit rates would not otherwise have provided the opportunity to shelter income from taxes via accelerated depreciation.

The outstanding policy question, however, involves incremental investment activity. Has the steel industry made significantly greater investment in energy-saving equipment because of ERTA and can it be expected to do so in the future? **Equivalently, because energy saving and cost reduction** are more or less accomplished by the same key technologies, has there been significantly greater investment in general?

Table 57.—Steel Industry Projects To Be Analyzed for Internal Rate of Return (IRR) Values

| | |
|-------------------------------------------------------------------------------------------------------------------------------------------------------------------------------------------------------------------------------------------------------------------------------------------------------------------------------------------------------------------------------------------------|-------------------------------------------------------------------------------------------------------------------------------------------------------------------------------------------------------------------------------------------------------------------------------------------------------------------------------------------------------------------------------------------------------------------------------------------------------------------------|
| <p>1. Electric arc furnace. -This furnace is used to melt steel scrap into molten metal suitable for secondary refining, rolling, and casting. Assuming scrap is available at reasonable prices, this investment will substantially lower product costs as well as save energy. Project life—10 years. Capital costs—\$20 million. First year cost savings—\$12 million.</p> | <p>overall effect is to lower inventory, yet maintain the ability to ship products to customers with little or no delay. In typical installations, working capital costs are dramatically reduced. Project life—5 years. Capital and installation cost—\$560,000. Energy savings—0 directly, but working capital could be reduced by \$1.2 million.</p> |
| <p>2. Reheat furnace.—Replacement of existing reheat furnaces improves energy efficiency because prolonged use would have degraded old unit and because the new unit embodies technological developments since the original unit was installed. Project life—10 years. Capital costs—\$12 million. First year cost savings—\$3.5 million.</p> | <p>6. Electric motors. -The steel industry uses electrical motors for rolling, mixing, pumping, and solid materials transfer. In this analysis, OTA has assumed that five aging electric motors will be replaced with newer, high efficiency ones. Project life—10 years. Capital and installation cost—\$35,000. Energy savings—\$16,000 per year at 4¢/kWh.</p> |
| <p>3. Continuous caster.—Continuous casting lowers costs and saves energy by eliminating costs of ingot casting (e.g., stripping, reheating, and primary rolling) and by reducing waste in the form of metal which must be returned to the steelmaking process. Project life—10 years. Capital costs—\$125 million. First year cost savings—\$30 million.</p> | <p>7. Computerized process control—The most common retrofit purchases being made for industrial systems are measuring gauges, controlling activators, and computer processors. The main accomplishment of such a process control system is to enhance the throughput and quality of a steel mill with only materials and small energy inputs. Project life—7 years. Capital and installation costs—\$500,000. Energy savings—\$150,000 per year.</p> |
| <p>4. Dry-quenching of coke.—Dry-quenching involves sealing the coke battery and thus in order to recover thermal and particulate emissions as finished coke is cooled. It results in higher yields and fuel savings besides reduced environmental emission. Project life—10 years. Capital costs—\$16 million. First year cost savings—\$2 million.</p> | <p>8. Steel mill cogeneration project.—Installation of a turbogenerator unit to recover electrical power from steam production facility. Superheated steam is produced at 600 psi and then passed through a mechanical turbine to generate electricity. The turbine exhaust, which is 175 psi steam, is used then for normal plant production. Project life—10 years. Capital and installation cost—\$231,000. Energy savings—\$72,300 per year.</p> |
| <p>5. Inventory control. -A computerized system can keep track of product item availability, location, age, and the like. In addition, these systems can be used to forecast product demand on a seasonal basis. The</p> | |

SOURCE: Office of Technology Assessment.

Table 58.—Effects of Policy Options on IRR Values of Steel Industry Projects

| Project | Reference case | IRR with policy options | | |
|-------------------------------|----------------|-------------------------|-----------|-----------------------|
| | | ACRS removed | 100% EITC | \$1/MMBtu tax no EITC |
| Electric arc furnace. | 57 | 55 | 63 | 57 |
| Electric motors | 43 | 43 | 48 | 43 |
| Reheat furnace | 31 | 29 | 35 | 37 |
| Continuous caster. | 25 | 24 | 30 | 26 |
| Process control | 16 | 17 | 22 | 16 |
| Dry-quenching | 13 | 12 | 16 | 13 |
| Waste heat boiler | 11 | 11 | 14 | 16 |
| Cogenerator | 11 | 11 | 15 | 17 |

SOURCE Office of Technology Assessment.

There is no short, quantitative answer. OTA has only **scattered data on 1981 investment behavior and even with a complete data set, calculation of the incremental impact requires knowing what investment would have been without ERTA.** Furthermore, since only a year has passed since ERTA became law, actual investment data would not reflect many large projects that may have been initiated as a result but have not proceeded beyond the planning stage. From 1979 through 1980 announcements for planned investments were as high as \$7 billion, a fact that strongly suggests that many steel firms believed that ERTA would sharply improve steel prospects. Unfortunately, many projects appear to have been shelved owing to deteriorating sales in 1982.

Regarding the CC and EAF, several pertinent observations can be made. Generic IRR calculations indicate that the accelerated cost recovery system (ACRS) marginally increases the profitability of both technologies (see tables 57 and 58). However, virtually all industry representatives indicated that such marginal improvement has almost nothing to do with actual investment decisions. For EAF, the very large potential reduction in cost per ton allows paybacks that are already in the range of 2 years. It takes longer to amortize a CC, but such investments must be made in order to meet the competition, both in quality and cost. The domestic industry realizes that both technologies are essential, and therefore these investments will proceed at a pace determined primarily by product market conditions and the availability of funds. Since most domestic steel firms are severely restricted **in their access to debt and equity markets**, ERTA has probably

increased steel investment only to the extent that it has actually increased retained earnings. Highly profitable minimills are the exception because they have relatively easy access to outside capital and so the ERTA tax savings can be leveraged into much larger actual investments.

In the energy savings and energy use projections shown in figure 39, ACRS helps cogeneration potential in this industry and encourages improvement in blast furnaces rather than greater reliance on electric arc furnaces—hence, the increase in purchased electricity and lower metallurgical coal demand **shown without the ACRS.** Overall energy, however, is not affected significantly since the most promising technologies here (CC and EAF) are likely to penetrate without the help of a new depreciation scheme.

Option 2: Energy Investment Tax Credits

Like ERTA, the energy investment tax credit (EITC) would have its greatest impact on steel investment by increasing retained earnings. As shown in table 58, it would have a somewhat greater impact on IRR, based on generic project data, but again the increment in IRR would be of small consequence compared to product demand assessments in decisions of whether or not to invest in a CC or EAF.

Energy projections in figure 39 show that an EITC would help the steel industry displace some of its natural gas use in high-temperature heating, mostly through better and wider use of heat recovery equipment. It would have less impact on the use of oil, since oil is not used as widely as gas in applications with heat recovery potential. As a result, total energy demand would change very little in response to the incremental savings from heat recovery.

Offsetting these limited financial benefits, several industry experts were concerned about why tax credits should be targeted to energy use at all. In their view, just about every major investment will involve energy conservation, so targeting may just mean unnecessary administration. Since their primary goal is to reduce total costs, they see no obvious reason why energy deserves more attention than do labor, capital, or materials. Indeed, special tax incentives for retrofits

Figure 39.—Steel Industry Projections of Fuel Use and Fuel Savings by Policy Options, 1990-2000

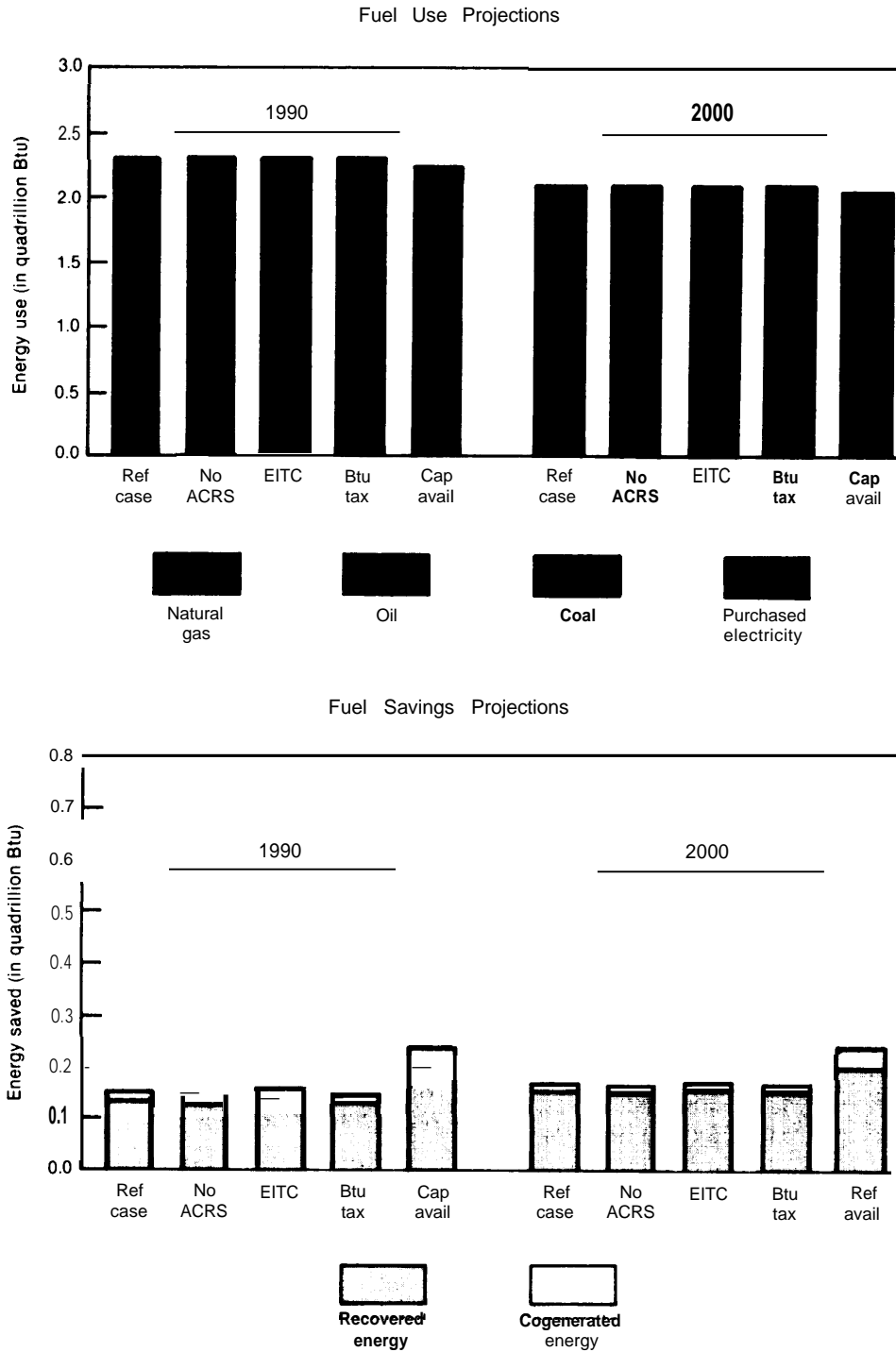

SOURCE: Office of Technology Assessment

(which presumably is how an EITC would apply) could delay or cancel construction of new plants, which many believe could be more efficient in the long run. They emphasized that they would be more concerned if oil were a significant fuel input. Instead, coal is by far the most important fuel, and at \$2.50/MMBtu, there seems to be little economic incentive to subsidize coal conservation.

Furthermore, many in the steel industry are disillusioned by their experience with the original EITC passed in 1978. At that time, the Treasury Department narrowly defined the list of qualifying equipment, excluding specifically the CC because the CC could be justified on grounds other than energy savings. Based on that experience, industry representatives fear that any new EITC legislation would suffer the same fate. Thus, they would rather focus their attention on more pressing issues, such as legislation to restrict imports.

Option 3: Tax on Premium Fuels

Like virtually all materials-intensive industries, the steel industry does not welcome additional taxes on key energy inputs. Approximately 3 percent of total U.S. gas consumption is used for steel. Gas accounts for about 20 percent of the steel industry's total energy supply (including energy for coking coal). Although the steel industry does not use a significant amount of oil directly, steel's primary industrial customers do—especially the auto industry, but also industries involved with consumer durables and construction. All of these industries are affected by oil and gas prices, and an across-the-board tax on these premium fuels would tend to depress what are already depressed activity levels in these industries. Another major concern was that such a tax would disadvantage U.S. firms compared to untaxed foreign competition, causing exports to decline and imports to rise.

However, if an energy tax were to help balance the Federal budget, and thereby lower interest rates and generally improve growth prospects for the GNP, the net impact on the steel industry could be positive. This prospect was considered too speculative compared to the obvious bias in the short run against industries whose fortunes rise and fall with prices of premium fuels.

OTA modeling projections, as shown in figure 39 indicate that a tax on premium fuels, when compared to the reference case, would have little impact on either energy saved or fuel used. This is to be expected, since the steel industry uses predominantly coal, and the policy option is designated not to apply to coal. The IRR calculations in table 58 also show little impact. However, despite its lack of effect on energy saved or used, the premium fuels tax would affect the steel industry in other ways, primarily by reducing demand for steel in autos and other consumer durables. Industry managers and experts with whom OTA consulted were unanimous in their condemnation of an energy tax as being a burden the steel industry, in its current depressed state, could not well bear.

Option 4: Low Cost of Capital

All respondents from the steel industry would like lower interest rates, ideally as a result of a general decline in the real cost of borrowing. Lower interest rates would make all capital-intensive industries more competitive, including the steel industry; and it would make steel-intensive consumer durables, such as home appliances and autos, more attractive. However, this prospect is not directly relevant to this study because a general lowering of interest rates is not really an energy policy option.

Instead, what is meant is a special concessionary rate for energy-intensive industries in general and the steel industry in particular. This would lower investment costs, but in order to be realistic, this policy option must limit the total amount of debt that would be covered. To make a difference, at least \$10 billion must be involved over a period of at least 5 to 10 years in order to convince a severely depressed industry to mount a large new effort to become more competitive. If \$10 billion were outstanding for 10 years, and if the subsidy were 5 percentage points, then Federal outlays would be \$5 billion, an amount that does not include *costs to the entire economy* as funds would be diverted from higher valued uses. A much smaller program could simply drive out privately placed debt with no net increase in total investment.

Assuming such a special program, however, this policy initiative would have greater impacts than the other policy options, both in terms of projected fuel use changes and in terms of illustrative rates of return for energy-related investment (compare tables 58 and 59). As seen in figure 39, natural gas and fuel oil use drops 3 to 5 percent, while coal and purchased electricity demand rise by compatible amounts. Total energy demand also drops (most noticeable in 1990) because of higher conservation through waste-heat recovery and higher investments in new energy-efficient technologies for processing and for cogeneration. Even though more in-plant electricity generation by utilities tends to increase the industry's fuel demand (since it is incurring more generation losses), the steel industry's total energy demand fell slightly. This decline results from the compensating factor of more efficient use of energy through increased waste-heat recovery.

Given that steel is not heavily dependent on oil, many respondents questioned how energy concerns could justify a large capital subsidy. Fur-

Table 59.—Effect of Lower Interest Rates on IRR Values of Steel Industry Projects

| | Reference case with 16% interest rate | IRR policy options: interest rate of 80/0 |
|------------------------------------------|---------------------------------------------|-------------------------------------------------|
| Inventory control | 3850/o | 370% |
| Electric arc furnace | 101 | 107 |
| Electric motors | 93 | 97 |
| Reheat furnace | 54 | 60 |
| Continuous caster | 46 | 53 |
| Computerized process control. | 36 | 44 |
| Waste heat boiler | 24 | 27 |
| Dry-quenching | 17 | 25 |

SOURCE: Office of Technology Assessment.

thermore, a large subsidy offer may not be accepted if domestic firms still do not expect to produce competitively. Conversely, loans may be obtained and then defaulted as optimistic sales projections do not materialize and firms become insolvent. Given many marketing uncertainties and a highly charged political atmosphere where many jobs are at stake, market viability issues would be exceedingly difficult to resolve.

Appendix

The Industrial Sector Technology Use Model

One approach to assessing the potential impact of legislative options on industrial energy use and related investment has been the use of the Industrial Sector Technology Use Model (ISTUM). * The ISTUM approach is to specify end-use energy services (e.g., bleaching in the pulp and paper industry) and to balance technologies providing similar services and outputs in order to predict minimum, direct, lifecycle costs. The model's fundamental decision criterion, minimum lifecycle costs, is used to assess market penetration levels of each competing energy service technology, after which it is possible to project total energy demand, fuel mix, and energy-related investment for each industry and for the overall industrial sector. It is the changes in these projections, resulting from the impact of various policy measures, that are used as part of OTA's assessment.

ISTUM provides a framework for a comprehensive accounting of energy use in the entire industrial sector. It focuses, however, on those industries that are major energy users and on those in which process heat or feedstocks are a significant share of required energy services. Thus, ISTUM targets iron and steel, pulp and paper, petroleum refining, and chemicals industries for particular emphasis. Together with aluminum these industries represent all of industry's feedstock energy

*ISTUM was developed as part of the Mellon Institute's Industrial Energy Productivity Project. Energy and Environmental Analysis, Inc., served as a subcontractor to the Mellon Institute under U.S. Department of Energy contract No. DE-AC01 -79CS-401 51.

uses, over 60 percent of current fuel use in boilers and nearly half of fossil fuel used in industrial process heat.

The key elements of organization of ISTUM are the 27 industrial sector classifications listed in table A-1 and the 52 energy service categories listed in tables A-2 and A-3. Primary emphasis is on energy end use rather than on fuels use. In steel making, for example, emphasis is on the energy needed to convert scrap and pig iron into liquid steel, to shape steel, and to increase the structural strength of steel products.

As shown in table A-2, ISTUM identifies 13 energy services as generic—i.e., common to most industries. These include such services as steam generation, mechanical drive, and space heating. Table A-3 lists the 39 industry-specific services, such as bleaching in the pulp and paper industry and heat treating in the iron and steel industry. This distinction is important because many energy services are generic, and thus there is a large market for energy efficiency-improving technologies throughout the industrial sector.

Figure A-1 lists the data inputs required for ISTUM and illustrates schematically this model's approach to projecting market shares of competing energy service-providing technologies.

The time horizon of ISTUM is long, extending to 2000 in 5-year increments. Its base year is 1976, the most recent year for which detailed energy use data is available from the U.S. Department of Commerce. Future industrial energy demands are calculated for each energy service by converting external (to the

Table A-1.—Standard Industrial Classification Codes Covered in ISTUM

| <i>SIC</i> | Name | SIC | Name |
|------------|------------------|------|--------------------------|
| . | Crops | 29 | Petroleum |
| 2 | Livestock | 30 | Rubber |
| 10, 14 | Nonenergy mining | 31 | Leather |
| 11-13 | Energy mining | 32 | Stone, clay, and glass |
| 15-17 | Construction | 331 | Iron and steel |
| 20 | Food | 3334 | Aluminum |
| 21 | Tobacco | 334 | Other primary metals |
| 22 | Textiles | 34 | Fabricated metals |
| 23 | Apparel | 35 | Nonelectric machinery |
| 24 | Lumber | 36 | Electric equipment |
| 25 | Furniture | 37 | Transportation equipment |
| 26 | Paper | 38 | Instruments |
| 27 | Printing | 39 | Miscellaneous |
| 28 | Chemicals | | |

SOURCE *Standard Industrial Classification Manual* (Washington, D C Office of Management and Budget, 1972)

Table A-2.—Generic Energy Services Used in the Industrial Sector Technology Use Model

Boiler generated steam
Cogenerated steam
Machine drive
Space, H, V, and AC
Electricity generation
Refrigeration
Transportation
Lighting
Direct steam
Heating, dirty
Heating, direct, clean
Drying, dirty
Drying, direct, clean

SOURCE: Mellon Institute, *Industrial Energy Productivity Project, Final Report*, vol. 1, Executive Summary, September 1982.

Table A-3.—Industry Specific Energy Services Used in the Industrial Sector Technology Use Model

| | |
|------------------------|----------------------|
| Lime calcining | Paper lime calcining |
| Concentration | Distillation |
| Paint drying | Cracking |
| Textile drying | Alkylation |
| Food drying | Hydrogen production |
| Metal melting | Hydrotreating |
| Forging | Reforming |
| Heat treating, generic | Agglomerate ion |
| Feed stocks | Iron making |
| Aluminum melting | Coking |
| Aluminum heating | Steel making |
| Aluminum electrolysis | Primary finishing |
| Brick firing | Secondary finishing |
| Cementmaking | Heat treating |
| Glass melting | Organic chemicals |
| Pulping | Inorganic chemicals |
| Bleaching | Plastics and resins |
| Papermaking | Chemical fertilizers |
| Chemical recovery | Chemical feedstocks |
| Pulp drying | |

SOURCE: Mellon Institute, *Industrial Energy Productivity Project, Final Report*, vol. 1, Executive Summary, September 1982.

model) projections of future product demand into requirements for specific energy services, taking into account anticipated material substitutions and production process changes.

ISTUM technological options are used in three ways: as potential energy conversion technologies, as potential energy carrier technologies, and as possible add-on conservation technologies. It is this multilevel approach that constitutes the basic framework of the technology market competition. Technology competition at each level reflects technology choices made at lower levels. The penetration rates of all technologies are determined after the top-level decision has been made. Relative market shares are then translated into actual investments, and technology penetrations and capital stocks are adjusted accordingly.

At the top level, energy conversion technologies (i.e., technologies used to process intermediate products or raw material inputs) compete—i.e., are compared side-by-side such that the most cost-effective technology can be identified. Alternative technologies in a given service category may perform the task differently, but will produce the same output. For example, in papermaking, conventional and displacement bleaching technologies can each treat pulps to the desired degree of brightness. These technologies compete against each other under the criterion of minimizing lifecycle cost per unit of product output.

At the next level, energy carrier technologies are compete—i.e., technologies that convert fuel forms to energy suitable for use in energy conversion technologies. For example, fixed- and fluidized-bed combustion technologies could compete in converting coal to useful process heat. In addition, several energy carriers could compete against one another for use in a particular conversion technology. For a given industry, ISTUM will examine the lifetime dollar costs of each energy carrier technology as a function of fuel, capital, labor, and materials costs, and identify that which provides the needed energy carrier at the best cost. These carriers could be primary fuels such as coal, oil, and natural gas, or a processed carrier such as electricity. Processed carriers may be generated within an industrial plant (e.g., low-Btu gas brought onsite as coal and processed in a gasifier) or purchased from an external utility or supplier. Competition at this level is based on minimizing cost per unit of energy service provided. Finally, either a carrier or conversion-level technology may benefit from the addition of equipment that improves the technology's efficiency of energy use. These add-on conservation options, such as heat exchangers, heat pumps, and computer control systems, are examined at the third level, where they compete against the value of the energy they would displace. This competition is based on minimizing cost per unit of energy required.

A key assumption underlying the market competition analysis is that the costs of alternative technologies cannot be represented adequately as single-point estimates, even at the level of disaggregation built into ISTUM. Site-specific factors will often affect costs significantly so that when all such cases are examined, a distribution of costs results. These distributions are developed explicitly within ISTUM.

Comparison of technologies on a lifecycle cost basis requires knowledge of how each industry discounts future costs and the accruing benefits of a given investment. In ISTUM, this aspect of industrial behavior is represented by an explicit discount rate applied over the useful period of the investment. With this approach, one-time investments and recurring operating,

Figure A-1.—Overview of the Industrial Sector Technology Use Model

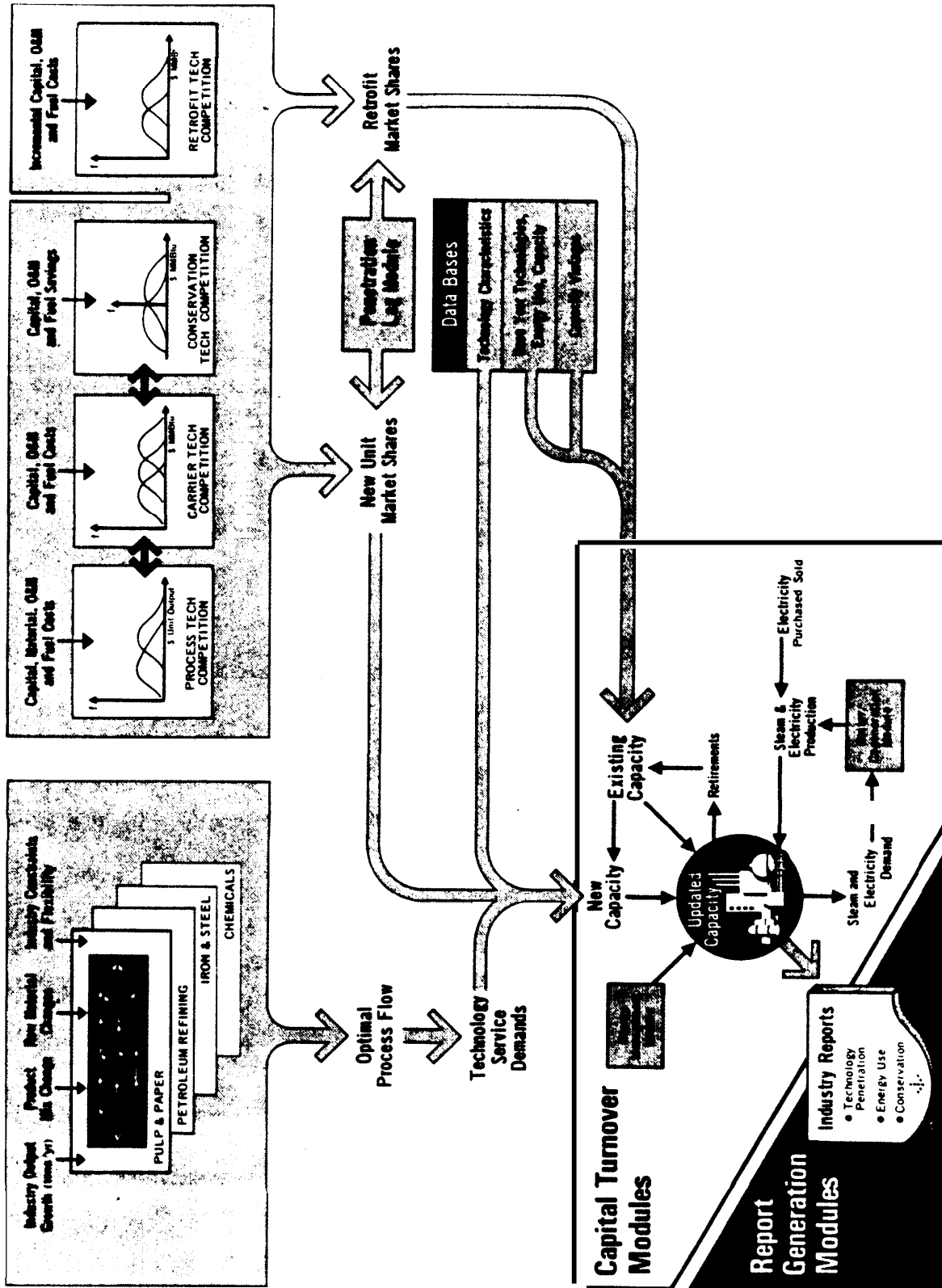

Project, Final Report, vol. 1, Executive Summary, September 1982.

SOURCE: Mellon Institute, Industrial

maintenance, and fuel costs can be placed on a common basis, thereby allowing different technologies to be compared on an equivalent basis.

Given the large number of industrial process steps and the even larger number of technologies available to carry out these steps, the first task of the ISTUM market competition analysis was to gather technologies into groups, known in the model as homogeneous cells. Each cell, corresponding to a particular energy service category, allows competition only among technologies that can substitute for one another or for other material or energy inputs. Where appropriate, further disaggregation within a cell can allow for consideration of product quality, marketplace safety, and minimization of environmental insult. In addition, distinctions within a cell are made for four capacity-size classes representing different product output rates (in units per year) and for four technology utilization factors representing the annual rate of unit use (in hours per year). These distinctions are made because some technologies may be technically constrained in certain size and utilization categories and because the costs per unit of output can change for technologies with different levels of output capability.

Within a model cell, basic equipment and other cost components are developed as individual building blocks, thus assuming consistent cost representation among different technologies. Each cell covers such items as process-related equipment, auxiliary equip-

ment, and indirect costs, and is often in the form of a cost distribution, reflecting variations based on site-specific factors. For example, evaluation of a new coal-fired steam boiler involves consideration of building blocks covering site preparation and powerhouse construction, the boiler and related equipment, fuel and waste handling equipment, environmental controls, installation, and indirect capital costs.

Three steps follow completion of the nominal market share competition. First, nominal market shares, derived by minimizing lifecycle costs, are modified by the results of a behavioral analysis. This analysis takes explicit account of the fact that actual industrial decisions are not entirely economically derived. The behavioral analyses incorporate a series of noneconomic-related "behavioral lags," thereby allowing ISTUM to model to delayed market penetration of certain energy service-providing technologies. These behavioral lags are intended to reflect a host of non-cost factors that cause investment decisions to deviate from strict cost minimization.

Second, given either nominal cost-minimum or behavioral-modified market shares, ISTUM transforms these shares into absolute levels of investment. Total demand for new equipment over a forecast period is derived from data on existing capital stock and rate of growth of product output. In addition, existing capital stock characteristics are modified to account for retrofit upgrade or replacement decisions.

Index

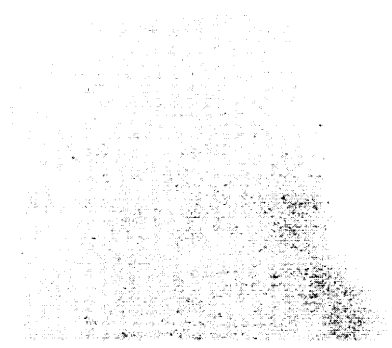

- accelerated cost recovery system (ACRS), 13, 15, 57, 76, 77, 110, 131, 158, 159
- A. D. Little, Inc., 99
- American Iron and Steel Institute (AISI), 144
- American Paper Industry (API), 71, 73
- American Petroleum Institute (API), 98
- Annual Survey of Manufacturers*, 42, 45, 115
- ARAMCO, 91
- Australia, 59, 60
- average depreciation range (ADR), 57
- Battelle Pacific Northwest Laboratories, 61
- B. F. Goodrich, 115
- Borden, 115
- Brazil, 145
- Bureau of Census, 42
- Bureau of Mines, 45
- Canada, 9, 59, 60, 61, 90
- Canadian National Energy Business Program, 61
- Carter, President Jimmy, 54
- Census of Manufacturers*, 42, 45, 65, 120
- Chemical and Engineering News*, 118
- Chemical Manufacturers Association (CMA)**, 121, 128, 129
- chemicals industry:
- ACRS, removal of, 131
 - capital, cost of, 135
 - capital investment, 118, 128, 135
 - decrease in energy use, 4
 - economics of production, 116
 - energy conservation, 121-128
 - feed stock:
 - availability, 124
 - requirements, 125
 - physical separation technologies, 126
 - premium petroleum fuels, **use of**, 124
 - production integration technologies**, 127
 - recovery, technologies** for, 127
 - energy intensity projections (fig. 2)**, 10, 12
 - energy investment tax credits (EITCs)**, 134
 - energy use**, 120
 - foreign competition**, 28, 118
 - imports and exports**, 118
 - investment strategy**, 130
 - overview**, 115-119
 - premium fuel tax, effect of**, 17, 135
 - processes, changing of**, 125
 - product demand**, 28
 - product mix**, 12, 115
 - production processes**, 119
 - ammonia, 119, 123
 - ethylene, 119
 - projects to be analyzed for IRR values (table 38), 131
 - reasons for study, 3
 - SIC major group 28, definition of**, 115
 - structure**, 115, 117
 - top 10 chemicals produced**, 116
- coal, 11, 13, 17, 18, 37, 42, 43
- converting to, 50, 51
 - gasification**, 103
 - liquefaction of**, 106
 - pollution control, 51
 - refinery fuel, 102
 - tax on, 16, 17, 37, 38, 39
 - cogeneration, 9, 15, 16, 17, 40, 55, 56, 77, 127
 - definition, 51, 55
 - environmental problems, 52
 - financial returns, 52
 - principal advantage, 51
- Council on Wage and Price Stability, 143, 144
- Dale Jorgenson Associates**, 7
- Data Resources, Inc.**, 7
- Denmark**, 61
- Department of Commerce**, 22, 47, 165
- Bureau of Economic Analysis (BEA)**, 22
- Department of Energy**, 4, 21, 30, 42, 43, 53, 55, 61
- Industrial Energy Reporting Program, 128
 - Office of Industrial Programs, 58, 73, 97, 98
 - Industrial Energy Conservation Program, 58
 - Implementation and Commercialization Program, 58
 - Industrial Cogeneration Program, 58
 - Industrial Process Efficiency Program, 58
 - Waste Energy Reduction Program, 58
- Department of Treasury, 161
- DHR, Inc., 61
- discretionary capital funds, 8
- Du Pont**, 121, 129
- Eastman Kodak**, 115
- energy growth rate projections (table 3)**, 7
- Energy Information Administration (EIA)**, 7, 45, 129
- energy price assumptions (table 2)**, 7
- energy-related technologies and processes**, 48-53
- computer control systems**, 48
 - combustion control**, 48
 - process control**, 49
 - electric motors**, 50
 - fuel switching**, 50
 - coal, **technology for converting**, 50, 51
 - cogeneration, 51, 52
 - product mix, 53
 - housekeeping**, 48
 - retrofitting**, 48
 - waste heat recovery**, 49
 - heat exchangers, 49
 - upgrading energy, 49
 - heat pump, 50
 - vapor recompression, 50
- Exxon, 107, 115
- Exxon Donor Solvent, 106
- Federal Energy Administration**, 55
- Federal Energy Regulatory Commission (FERC)**, 54, 55, 56
- Federal Reserve Board**, 47, 121
- France, 61, 145
- Gordian Associates**, 99

- gross domestic product (GDP), 59
- gross national product (GNP), 7, 21, 22, 27, 28, 29, 43, 58, 66, 139, 143, 155, 161
- Gulf Oil Co., 97
- Gulf Research & Development Co., 97
- H-Oil, 106
- Illinois, 143
- Indiana, 143
- industrial energy demand, 1950-2000, (fig. 1), 5, 6
- industrial energy use:
- characteristics of, 39-47
 - determinants of, 40
 - cost of equipment, 41
 - Government regulations, 41
 - level of technology, 41
 - product demand, 40
 - relative price of energy, 41
 - use of capital equipment, 41
 - end-use profile, 45
 - qualitative characteristics of, 41
 - capital effects, 43
 - capital intensiveness, 41
 - process-specific technologies, 42
 - raw material use, 42
 - shifts in energy use, 42
 - use of captive energy, 42
 - quantitative characteristics of, 43
 - energy use by divisions, 43
 - overall consumption, 43
 - self-generation, 40
 - trends in energy use, 46
 - between 1947 and 1972, 46
 - since 1972, 47
 - variability of energy intensiveness, 45
 - costs of, 37, 38
 - decline, 4, 9, 11, 12, 46, 47
 - foreign policy, 58-61
 - implications for the United States, 61
 - growth rate projections, 7
 - improved efficiency and conservation, 4, 5, 6, 7, 8, 9, 11, 13
 - investment considerations, 8, 9
 - capital, 8
 - competition, 8
 - Government policy, 8
 - material and labor, 8
 - product demand, 8, 27, 40
 - projections, 13
 - two major alternatives, 7
 - policies that affect, 53-58
 - Federal regulations, 55
 - financial incentives, 56, 57
 - Industrial Energy Conservation Program, 58
 - pricing issues, 53
 - prices, 1970-81 (fig. 8), 39
 - projections of the four major sources, 13
 - sources of, 37
 - use by source (table 6), 38
- industrial investment, 24-26
- capital, 24, 66, 89, 112, 118, 141, 142
 - chemicals industry, 118, 128, 130
 - factors that influence, 27
 - housekeeping, 25
 - management responsibilities, 24, 27
 - new construction, 25
 - nonoil-related, 107
 - paper industry, 73
 - product shift, 26
 - refining industry, 104
 - retrofit of equipment, 25
 - steel industry, 141, 155
- industrial sector, 21-23
- definition of, 21
 - distribution of employment (fig. 6), 23
 - employment, 22
 - energy consumption, 43, 44, 45
 - productivity, 22
 - output in (fig. 5), 22
 - overall energy consumption, 43
- Industrial Sector Technology Use Model (ISTUM), 107, 108, 130, 131, 134, 135, 165-168
- internal rate of return (IRR), 33, 34, 74, 75, 76, 77, 79, 80, 81, 107, 108, 110, 111, 112, 130, 134, 135, 156, 158, 159, 161, 162
- Internal Revenue Service, 15, 111
- International Energy Agency (IEA), 58, 59, 60
- International Trade Commission, 28
- investment tax credit (ITC), 57, 110
- Iran, 26
- Italy, 59, 60
- Japan, 59, 60, 61, 144, 145
- Korea, 145
- legislation:
- Crude Oil Windfall Profits Tax Act (WPTA), 54, 56
 - Economic Recovery Tax Act of 1981 (ERTA), 3, 13, 56, 57, 130, 156, 158, 159
 - Energy Policy and Conservation Act (EPCA), 53, 58
 - Energy Tax Act of 1978 (ETA), 56
 - Environmental Supply and Environmental Coordination Act (ESECA), 55
 - Federal Power Act, 56
 - Natural Energy Conservation Policy Act of 1978 (NECPA), 58
 - Natural Gas Policy Act (Public Law 95-621), 7, 54
 - Omnibus Budget Reconciliation Act of 1981, 55
 - Powerplant and Industrial Fuel Use Act (FUA), 55
 - Public Utility Regulatory Policies Act (PURPA), 52, 55, 56
 - Tax Equity and Fiscal Responsibility Act of 1982, (TEFRA), 57
- Marathon Oil Co., 95
- Marcor, 107
- Mexico, 90, 119, 124
- Michigan, 143
- Minerals Yearbook, 45

- Mobil Oil Co., 107, 115
 Montgomery Ward, 107
- natural gas, decontrol, 54
 Netherlands, 61
- Oak Ridge National Laboratory, 99
 Occupational Safety and Health Administration, 31
 Office of Technology Assessment (OTA), 3, 4, 5, 6, 7, 8, 9, 11, 12, 13, 15, 16, 17, 18, 25, 33, 34, 50, 75, 79, 80, 101, 104, 107, 108, 112, 115, 118, 122, 126, 129, 130, 135, 155, 156
 Ohio, 143
Oil and Gas Journal 105
 oil decontrol, 54
 OPEC, 12
- Pennsylvania, 143
 petroleum refining industry:
 atmospheric fluidized-bed combustion (AFBC), diagram of (fig. 25), 103
 capital expenditures, 104
 capital investment, 89, 104, 105, 107
 coal, use, of, 102
 conventional firing, 102
 corporations earning more than \$16 billion in 1981 (table 22), 86
 crude-running capacity, 85
 decrease in energy use, 4, 11
 domination by vertically integrated firms, 11
 economics, 88, 89
 employment, 88
 energy conservation:
 air and water cooling of process streams, 99
 fractionation efficiency, 101
 housekeeping measures, 101
 instrumentation and controls, improvement, 100
 insulation, improvement, 100
 process heat exchange, improvement, 100
 process heaters and steam boilers, 99, 101
 pump efficiency, 100
 recovery from process streams, 100
 refinery loss control, 101
 steam system improvements, 100
 energy intensity projections (fig. 2), 10
 energy investments:
 alternative energy sources, 106
 geothermal energy production, 106
 nonoil-related, 107
 oil shale mining and processing, 107
 petrochemicals, 106
 synfuels: liquefaction of coal, 106
 energy losses, 97
 energy use, 95
 fluidized-bed combustion, 102
 foreign competition, 89, 90
 increased energy efficiency, technologies for, 99, 101
 low-level heat:
 mechanical recovery of, 104
 thermal recovery of, 104
 overview, 85
 Petroleum Administration for Defense districts, 85
 potential for energy saving, 98
 premium fuel tax, effect of, 17, 111
 product demand, 27, 88
 product mix, 86, 87
 production costs, 89
 production processes:
 alkylation, 93
 atmospheric distillation, 92
 catalytic reforming, 92
 coking, 94
 fluid catalytic cracking, 92
 hydrocracking, 93
 hydrotreating, 93
 residuum desulfurizing, 93
 vacuum distillation, 92
 projects to be analyzed for IRR values (table 26), 108
 reasons for study, 3
 reduction in demand, 11
 refineries, kinds of:
 complex, 94
 hydroskimming, 94
 topping, 94
 SIC major group 29, 85, 87, 88
 structure, 85-86
 trends and uncertainties:
 changing crude mix, 91
 crude oil prices, 91
 crude supply, 91
 environmental constraints, 92
 motor gasoline upgrading, 92
 residual fuel oil demand, 91
 unleaded gasoline, 90
 policy options, 13-18, 75-81, 107-111, 129-135, 156- 62
 ACRS, removal of, 13, 15, 77, 110, 131, 134, 158
 chemicals industry, 129
 industrial sector, effects on, 18, 77, 131
 energy investment tax credits (EITCs), 13, 15, 16, 79, 110 134, 159
 low cost of capital, 13, 17, 80, 112, 135, 161
 paper industry, 75
 petroleum refining industry, 107
 steel industry, 156
 tax on premium fuels, 13, 16, 17, 79, 111, 135, 161
 pulp and paper industry:
 ACRS, removal of, 79
 biomass fuel, 10
 capital investment, 66, 80
 conservation improvements, 9, 10, 73
 corporations earning more than \$1 billion in 1981 (table 15), 66
 economics, 66
 employment, 67
 energy consumption, 71
 energy intensity projections (fig. 2), 10
 energy investment tax credits (EITCS), 79
 exporting, 67
 foreign competition, 9, 28, 67
 overview, 65-67

- premium fuels tax, 16, 79
- product demand, 28, 66
- product mix, 66, 67, 76
- production processes:
 - bleaching, 69
 - papermaking, 70
 - process control, 71, 77
 - pulping, 67, 68
 - recovery operations, 71
 - refining and repulping, 70
- projects to be analyzed for IRR values, 74
- reasons for study, 3
- rise in energy use, 4
- SIC major group 26, 65
- structure, 65
- Union Camp, Savannah, Ga., 66

- Reagan administration, 58
- Reliance Electric, 107
- Resources for the Future (RFF), 59

- Saudi Arabia, 90
- South Africa, 106
- Spain, 61
- SRC-11, 106
- Standard Industrial Classification (SIC), 21, 65, 85, 87, 115, 139, 165
- Standard Oil, 86, 105
- steel industry:
 - ACRS, removal of, 158
 - capital, cost of, 29, 161
 - continuous caster, 150, 153, 156, 158
 - declining domestic sales, 12
 - decrease in energy use, 5, 12
 - economics, 141
 - capital investment, 141, 142
 - employment, 143
 - imports and exports, 144
 - product demand, 144
 - production costs, 143
 - profitability, 141
 - electric arc furnace, 152, 158
 - energy conservation, 152
 - energy intensity projection (fig. 2), 10
 - energy investment tax credits (EITCs), 159, 161
 - energy use, 149
 - foreign competition, 28, 144
 - investment strategy, 155
 - major U.S. companies, shipment by, 140
 - overview, 139-145
 - premium fuels, tax on, 17, 161
 - product demand, 28
 - product mix, 141
 - production processes:
 - heat treating, 149
 - ironmaking, 147
 - primary finishing:
 - continuous casting, 147
 - ingot casting, 147
 - raw materials, preparing of, 145
 - benefication of iron ore, 145
 - coking, 145
 - secondary finishing, 149
 - steelmaking, 147
 - projects to be analyzed for IRR values (table 57), 158
 - raw steel production by State, 1980 (table 49), 141
 - reasons for study, 3
 - representative energy-related technologies (table 54), 154
 - SIC major group 33, 139
 - structure, 139
 - strategic planning, 26-34
 - capital, cost and size of, 28
 - competition, 28
 - elements of, 31
 - financial analysis, 32
 - investment decisions, 27, 155
 - investment levels, 32
 - levels of decisionmaking, 30
 - material and labor, costs of, 29
 - product demand, 27
 - sensitivity analysis, 34
 - time considerations, 31
 - Sweden, 59, 60, 61

 - United Kingdom, 59, 60, 61
 - U.S. Constitution, 56
 - U.S. Supreme Court, 55, 56
 - U. S. S. R., 119, 124

 - Venezuela, 90

 - West Germany, 59, 60, 61, 145