

*Energy Efficiency of Buildings in Cities*

March 1982

NTIS order #PB82-200346

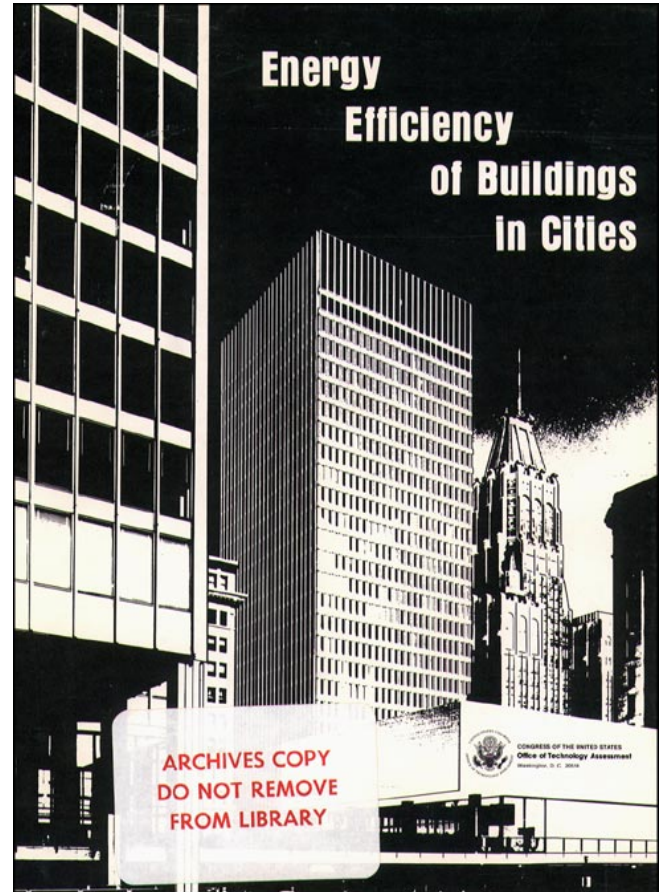

**Library of Congress Catalog Card Number 82-600522**

For sale by the Superintendent of Documents,  
U.S. Government Printing Office, Washington, D.C. 20402

# Foreword

This assessment responds to a request by the House Committee on Banking, Finance, and Urban Affairs for an evaluation of the impact on buildings found in cities, of energy price increases, and of Federal policies to encourage energy efficiency and the use of renewable energy in buildings. By focusing on multifamily and commercial buildings the report complements an earlier OTA study, Residential Energy Conservation, which analyzed the potential for improved energy efficiency of single-family houses.

The report examines the potential for increased energy efficiency in buildings found in cities from two perspectives: that of the energy expert who assesses technical opportunities for improved energy efficiency, and that of the real estate expert who evaluates the financial attractiveness of real estate investment opportunities. The study categorizes existing buildings according to their technical retrofit potential; it also groups building owners according to the likelihood that they will invest in retrofits. It assesses the prospects for large-scale stimulus of building retrofit by private businesses, public utilities, and city and State governments. Several options for Federal policies towards building retrofit are provided. The study also includes an analysis of the technical and economic feasibility of district heating in cities.

We are grateful for the assistance of the project advisory panel, as well as for the background work done by several contractors and the advice of numerous reviewers in State and local governments, universities, public interest groups, and business. It should be understood, however, that OTA assumes full responsibility for this report which does not necessarily represent the views of individual members of the advisory panel.



JOHN H. GIBBONS  
*Director*

# Energy Efficiency of Buildings in Cities Advisory Panel

|  |   |  |
|--|---|--|
|  | William Reilly, Chairman<br>Conservation Foundation |  |
| Francis Hooks Burr<br>Attorney<br>Ropes & Gray | Hewitt Lovelace<br>Public Safety Director           | Victoria J. Tschinkel<br>Florida Department of<br>Environmental<br>Regulation                      |
| Vernon Friason<br>Real Estate, F&H Services    | Neal R. Peirce<br>National Journal                  | James A. Walker<br>California Energy<br>Resources<br>Conservation and<br>Development<br>Commission |
| Lenneal Henderson<br>Howard University         | George Peterson<br>The Urban Institute              | Joseph E. Widmayer<br>Complete Building<br>Services, Inc.  |
| Michael Hogan<br>Utility Consultant            | John H. Robson<br>Marquette Fuels                   |  |
| George Latimer<br>Mayor, City of St. Paul      | Terry L. Sinnott<br>San Diego Gas & Electric        |  |

## Review Group: Existing Building Retrofits

|  |                                   |  |
|--|-----------------------------------|--|
| Dean Alford<br>Claude Terry & Associates   | Robert Naismith<br>Energy Auditor | Howard Ross<br>Department of Energy              |
| Paul Anderson<br>Honeywell Control Systems | Travis Price<br>Architect         | Joseph E. Widmayer<br>Complete Building Services |
| James Mays<br>Energy Auditor               |                                   |  |

## Review Group: Building Owners' Criteria for Energy Retrofit Investments

|  |   |   |
|--|---|---|
| Harley Barnes<br>Hittman Associates                  | Robert Dubinsky<br>Private Consultant                         | Alisa Gravitz<br>Department of Energy                           |
| Thomas Black<br>Urban Land Institute                 | David Engel<br>Department of Housing and Urban<br>Development | Arthur Rieger<br>Department of Housing and Urban<br>Development |
| Deborah Bleviss<br>Federation of American Scientists |   |   |

## Working Group on Policy Options for Bringing About Large= Scale Retrofit of Low= and Moderate= income Housing

|  |   |   |
|--|---|---|
| John Alschuler*<br>Hartford Policy Center                      | David Engel<br>Department of Housing and Urban<br>Development | Judy Kossy<br>Department of Housing and Urban<br>Development    |
| Richard Burk<br>Department of Housing and Urban<br>Development | Dennis Feck<br>Department of Energy Weatherization            | Francis Luzzato<br>ACTION<br>Meg O'Hare<br>Department of Energy |
| Allen Cohen<br>Department of Health and Human<br>Services      | Gene Frankel<br>House Committee on Science and<br>Technology  | Arthur Reiger<br>Department of Housing and Urban<br>Development |
| Lynn Collins<br>Alliance to Save Energy                        | Wayne Gathers* *<br>Department of Energy                      | Tamara Stanton<br>ACTION  |

\*Currently City Manager of Santa Monica, Calif.

\*\* Currently at the Alliance to Save Energy.

## **OTA Energy Efficiency of Buildings in Cities Project Staff**

Lionel S. Johns, Assistant Director, OTA  
Energy, Materials, and International Security Division

Richard E. Rowberg, Energy Program Manager

Mary E. Procter, Project Director

Eric Bazques\*     Burton Goldberg\*     Doreen McGirr\*

Joanne Seder     Nancy Naismith

### *Administrative Staff*

Virginia Chick     Marian Grochowski     Lillian Quigg     Edna Saunders

### *Contractors and Consultants*

Energyworks, Inc.  
Steven Ferrey & Associates  
Alan Meier  
Real Estate Research Corp.

Jane Silverman  
Temple, Barker & Sloane, Inc.  
Frederick Winkelmann

## **OTA Publishing Staff**

John C. Holmes, Publishing Officer

John Bergling     Kathie S. Boss     Debra M. Datcher     Joe Henson

---

\*OTA contractor.

## Acknowledgments

OTA thanks the following people who took time to provide information or to review part or all of the study.

Thomas Bull, Office of Technology Assessment  
Clark Bullard, University of Illinois  
Thomas Casten, Cogeneration Development Corp.  
Gary Dodge, Office of the Mayor, St. Paul, Minn.  
Jack Gleason, Institute for Local Self-Reliance  
Paul Greiner, Edison Electric Institute  
Eric Hirst, Oak Ridge National Laboratory  
Eric Leber, American Public Power Association  
Gerald M. Mara, Center for Renewable Resources  
Richard Morgan, Environmental Law Institute  
Beth McPherson, Center for Renewable Resources  
Bruce McCarthy, New England Electric System

Lou McLelland, University of Colorado  
Hans Nyman, St. Paul District Heating Development Co.  
Deborah Pederson, Office of Technology Assessment  
Jenifer Robison, Office of Technology Assessment  
Danilo T. Santini, Argonne National Laboratory  
Barry Siegus, Conference of Mayors  
Lawrence G. Spielvogel, Consulting Engineer  
Steve Strahs, Northeast Solar Energy Center  
David Strom, Office of Technology Assessment  
Norman Taylor, International District Heating Association  
Jerry Wade, Economist and Private Consultant

## Reviewers of Case Study Materials

### Buffalo, N.Y.

Richard Coley, Buffalo Savings Bank  
Richard Deptula, Niagara Mohawk Power Corp.  
John Garfield, Office of the Erie County Executive  
Gerald Kelly, Greater Buffalo Development Foundation  
Robert Litzenburger, Buffalo Energy Project  
Thomas J. Murphy, Office of the Mayor  
Kenneth E. Sherman, New York Public Interest  
Research Group, Inc.  
Arthur F. Worden, Wilson, Klaes, Brucerk & Worden,  
Consulting Electrical and Mechanical Engineers

### Des Moines, Iowa

Barbara J. Ashton, Office of Neighborhood Development  
Richard L. Bryan, Des Moines Savings  
Martha Hock, Citizens United for Responsible Energy  
Robert Mickle, City Planning and Zoning Commission  
Craig Severance, Iowa Center for Local Self-Reliance  
Linda Wheaton, Neighborhood Housing Services  
E. E. Young, Iowa Power

### Tampa, Fla.

Jan Abell, Local Community Design Center  
H. D. Cusick, Greater Tampa Chamber of Commerce  
Renee T. Faass, Energy Conservation Coordinator  
Richard D. Garrity, Department of Public Works  
G. J. Kordecki, Tampa Electric Co.  
Ron Rotella, Director of Housing Inspections

### Jersey City, N.J.

Harold A. Duncan, McConnell Fuel Oil Co.  
Charles W. Lawrence, New Jersey Energy  
Research Institute  
Steven Miller, Office of the Mayor  
John S. Nettleton, Planner, Rick Cohen & Associates  
Sam Tsarinides, Department of Human Services

### San Antonio, Tex.

Lou Fox, Deputy City Manager  
Mary Flurry, Department of Planning  
Mike Garcia, Mexican-American Unity Council  
Rolan Lozano, Department of Planning  
Howard G. Rogers, Energy Consultant  
William R. Sinkin, Texas Bank  
F. E. Thornton, City Public Service

# Contents

| Chapter  | Page |
|--|------|
| 1. introduction and Summary of Findings . . . . .  | 3    |
| 2. Importance of City Buildings in National Energy Use: Will Energy Efficiency Make a Difference. . . . .        | 27   |
| 3. Technical potential for improving the Energy Efficiency of Buildings in Cities. . . . .                       | 41   |
| 4. Will Building Owners Invest in the Energy Efficiency of City Buildings? . . . . .                             | 99   |
| 5. Retrofit for the Housing Stock of the Urban Poor. . . . .   | 143  |
| 6. Prospects for District Heating. . . . .   | 165  |
| 7. Private Sector Efforts to Stimulate Energy Retrofit of Buildings . . . . .                                    | 197  |
| 8. Potential Role of Utilities Improving the Energy Efficiency of Buildings. . . . .                             | 211  |
| 9. public Sector Role in Urban Building Energy Conservation. . . . .   | 241  |
| 10. Case Studies. . . . .  | 269  |
| 11. public Policy Options. . . . .   | 299  |
| Appendixes   |      |
| A. Options for Thirteen Building Types in the St. Louis Climate Zone. . . . .                                    | 313  |
| B. Estimated Cumulative Energy Savings From Packages of Retrofits for Thirteen Different Building Types. . . . . | 327  |
| C. Retrofit Descriptions. . . . .  | 334  |
| D. Sources for Retrofit Costs and Savings . . . . .  | 359  |

**Chapter 1**

# **Introduction and Summary of Findings**



# Contents

|  | Page      |
|--|-----------|
| <b>Introduction</b> . . . . .  | <b>3</b>  |
| <b>Summary of Findings</b> . . . . .   | <b>4</b>  |
| overview . . . . .   | 4         |
| <b>Building by Building Retrofit Potential.</b> . . . .  | <b>5</b>  |
| <b>Technical Description.</b> . . . . .  | <b>5</b>  |
| <b>Capital Costs</b> . . . . .   | <b>7</b>  |
| <b>Importance of Solar Retrofits.</b> . . . . .  | <b>8</b>  |
| <b>The Difficulty of Predicting the Outcome of<br/>a Retrofit to a Particular Building</b> . . . . . | <b>9</b>  |
| <b>Will Owners of City Buildings Invest in the<br/>Energy Efficiency of Their Buildings? . . . .</b> | <b>10</b> |
| <b>Why Do Homeowners Forego the Large<br/>    Potential Returns on Retrofit? . . . . .</b>           | <b>12</b> |
| <b>High Cost of Finance. . . . .</b>   | <b>12</b> |
| <b>impact of Risk. . . . .</b>   | <b>12</b> |
| <b>The Impact of Two Forms of Subsidies:<br/>    Lower Financing Costs and Tax Credits.</b> . . . .  | <b>13</b> |
| When the Building Owner is the<br>Government . . . . .   | 14        |
| General Prospects for Retrofit of<br>Buildings in Cities. . . . .                                    | 14        |
| Prospects for District Heating . . . . .   | 15        |
| Prospects for Private Sector Marketing<br>of Energy Retrofits . . . . .                              | 15        |
| Will Gas and Electric Utilities Stimulate<br>Investment in Energy Retrofits? . . . . .               | 17        |
| Public Sector Programs to Stimulate Energy<br>Retrofits . . . . .                                    | 17        |
| Potential Role of City Governments<br><b>in Urban Building Retrofit. . . . .</b>                     | <b>17</b> |
| <b>Potential Role of State Governments<br/>    in Urban Building Retrofit . . . . .</b>              | <b>19</b> |

|   |           |
|---|-----------|
| <b>The Future: Federal Policy Options for<br/>Stimulating the Retrofit of Buildings<br/>in Cities</b> . . . . . | <b>20</b> |
| Option A: No Intervention . . . . .   | 20        |
| Option B: Small Federal Market<br>Assistance Role. . . . .  | 20        |
| Option C: Large Active Federal Role. . . . .  | 21        |

## LIST OF TABLES

| Table No.  | Page      |
|--|-----------|
| 1. <b>The Gap Between Likely Energy Savings<br/>Through Retrofit and Technically<br/>Feasible Savings by the Year 2000:<br/>Building Types Covered in This Report. . . . .</b> | <b>5</b>  |
| 2. <b>Thirteen Types of Buildings With<br/>Significantly Different Retrofit Options.. . . .</b>  | <b>7</b>  |
| 3. <b>Three Ways to Express the Relative Cost<br/>Effectiveness of Energy Retrofits . . . . .</b>  | <b>8</b>  |
| 4. <b>Retrofit Payback Criteria, Holding Periods<br/>and Access to Financing, and Advice for<br/>Different Types of Owners. . . . .</b>  | <b>11</b> |
| 5. <b>Owners Likely, and Not Likely to Retrofit<br/>Their Buildings . . . . .</b>  | <b>14</b> |
| 6. <b>Two Forms of Federal Subsidy . . . . .</b>   | <b>21</b> |

## FIGURE

| Figure No.   | Page      |
|--|-----------|
| I. <b>Combinations of Loan Terms and Interest<br/>Rates Which Allow the Value of Energy<br/>Savings to Exceed the Cost of Borrowed<br/>Money the First Year. . . . .</b> | <b>13</b> |

# Chapter 1

## Introduction and Summary of Findings

---

### INTRODUCTION

The future of buildings in this Nation's cities arouses both interest and concern. Great department stores and hotels, museums and cultural centers are by and large to be found in cities. The office buildings of the financial districts of New York, Chicago, Houston, and San Francisco shelter major economic decisions affecting our Nation. Some of the most exciting modern real estate development has occurred within cities—Baltimore's Harbor Place, Boston's Quincy Market and San Francisco's Ghirardelli Square. The Nation's rediscovery of its own past has found expression in loving restoration of Victorian homes in such cities as Savannah, Cincinnati, Pittsburgh, and Hartford. Elsewhere, however, empty factories and boarded up tenements in cities are reminders of economic stagnation and population shifts. Some magnificent old buildings in cities stand crumbling amid pitted streets and recalcitrant ancient sewers, testimony to the failure to maintain the architectural and engineering legacies of the past.

One contributor to the economic difficulties of buildings in cities has been the rise in the cost of energy. This study of the energy efficiency of buildings in cities has a double focus, arising both from concern about the Nation's cities and the viability of their building stock and from concern about the Nation's energy future and the prospects for increased energy efficiency in the building sector.

Looked at from the point of view of urban policy this report deals with the energy efficiency of commercial and multifamily buildings because such buildings are important in the building stock of U.S. central cities. Over half of the denser forms of housing—attached houses, small multifamily buildings with up to four apartments and larger multifamily buildings—are located in central cities.

From an energy policy perspective, the buildings that are the primary subject of this re-

port—all commercial buildings, all multifamily buildings, all housing occupied by low-income people, and single-family homes located in central cities—are also important. These categories of buildings together used about 14 Quads of primary energy in 1980, half of all U.S. building energy in that year. Most of the rest of energy in buildings was used by middle and upper income single-family homes located outside central cities (about 10 Quads of primary energy). The technical and economic prospects for improved energy efficiency of single-family homes were dealt with in an earlier OTA report *Residential Energy Conservation*. \*

This report attempts to bridge the gap between urban and housing specialists, on the one hand, who understand such subjects as primary and secondary mortgages, building codes, and the ins-and-outs of municipal bonds, and, on the other hand, energy specialists who are expected to understand building envelope efficiencies, heating system efficiencies, utility load forecasting, and load management potential. Both sets of specialists must understand some of the others' expertise if sensible building energy policy (including deliberate nonintervention) is to be made. The analysis is from the perspective of various different actors in the field with potential impact on building retrofit—including the energy auditor or retrofit contractor, the real estate financial analyst, and the city energy program director. The analysis attempts to assess energy conservation opportunities in the context of real estate decision making.

Many aspects of the energy efficiency of buildings are not affected by the building location—urban, suburban, or rural. This report treats buildings regardless of location in several chapters: chapter 2, projections of building energy use; chapter 3, technical prospects for

---

\*Office of Technology Assessment, U.S. Congress, *Residential Energy Conservation*, OTA-E-92 (Washington, D. C.: Government Printing Office, July 1 1979).

improved energy efficiency of buildings; chapter 7, private sector marketing of energy conservation; chapter 8, utility conservation programs; and chapter 9, State and Federal energy conservation programs.

On the other hand, an urban location does influence some aspects of real estate decision-making and local government policy. The discussion of building owner motivation (ch. 4) is based on interviews with owners of buildings in central cities. The description of local government programs (in ch. 9) deals only with city government and may not apply to suburban, small town, or county government. The report includes a set of case studies (ch. 10) drawn exclusively from central cities: Buffalo, N.Y.; Jersey City, N. J.; Des Moines, Iowa; Tampa, Fla., and San Antonio, Tex. Finally, the chapter on district heating (ch. 6) describes a technology which is primarily suitable for cities, although it may be feasible elsewhere under the right circumstances.

In order to avoid covering ground that has been amply covered elsewhere, this report does not address, except in passing, several topics which also have a bearing on the development of national energy policy for the building sector. The report mentions but does not discuss extensively the many factors which have influenced

the development of a national energy policy in recent years, such as national security considerations, balance of payments or conservation of capital resources. Nor does the report examine the basis for alternative projections of energy use in the building sector, although it does present a simple projection of building energy use for purposes of placing the more detailed examination of the building sector in context. The report assesses the practical potential for building retrofit but does not itself set out to define the technically optimum degree of conservation investment. Rather it seeks to compare what seems practical and feasible for some actual buildings with what is likely to occur in the majority of buildings.

Finally, the reader is cautioned against over-generalization. In buildings, as in many other aspects of everyday life, there are many special situations. Just as buildings differ widely in their energy use and retrofit characteristics, many individuals, companies and building owners will vary in their choices of investment. The diversity that characterizes the opportunities for conservation makes it difficult to make universally applicable statements. The report seeks rather to explain and examine the many factors that underly that diversity, so that Federal policies may take advantage of, rather than be thwarted by, these individual choices.

## SUMMARY OF FINDINGS

### Overview

Overall, OTA estimates that about 7 Quads\* per year of energy savings is technically possible by 2000, through feasible\*\* investments in the improved energy efficiency of building types covered in this report (see table 1). Nearly 3

\*A Quad equals a quadrillion Btu of energy, a very large unit of energy. It is equivalent to about 500,000 barrels of oil per day for a year, or about 50 million tons of coal, or the output of 18 1,000-MW powerplants at average utilization. Seven Quads is equivalent to the energy of more than two-thirds of the oil the United States imported in 1981.

\*\*Feasible investments are defined as those which in 1981 are technically feasible and which would be cost effective over a 20-year lifetime, assuming no real increases in energy prices and a 3-percent real return on investment.

Quads of these potential energy savings are likely to come about because of investments in energy efficiency made by building owners who have personal or business reasons to invest money in improved energy efficiency of their buildings.

**The other 4 Quads of potential energy savings, on the other hand, may not occur because building owners fail to make investments in the energy efficiency of their buildings.** Part of the failure to retrofit is due to the difficulty and costliness of improvements in energy efficiency to some building types. Part of the failure is due to building owners' stringent

requirements for return on investments in energy efficiency. The diversity of buildings and

owners and their implications for national energy use is described below.

**Table 1.—The Gap Between Likely Energy Savings Through Retrofit and Technically Feasible Savings by the Year 2000: Building Types Covered in This Report (quadrillion Btus of primary energy)**

|   | Projected energy use <sup>a</sup> | Technical savings potential | Likely savings <sup>c</sup> | Gap: technical savings potential not realized |
|---|-----------------------------------|-----------------------------|-----------------------------|---|
| Multifamily buildings (all) . . . . .                             | 2.4                               | 1.0                         | 0.3                         | 0.7   |
| Commercial buildings (all). . . . .                               | 6.3                               | 3.5                         | 1.3                         | 2.2   |
| Low income single family (all). . . . .                           | 1.6                               | 0.8                         | 0.2                         | 0.6   |
| Moderate and upper income single family homes in cities . . . . . | 3.5                               | 1.8                         | 0.9                         | 0.9   |
| Total buildings covered in this report . . . . .                  | 13.8                              | 7.1                         | 2.7                         | 4.4   |

<sup>a</sup>Projected energy use in 2000 assumes no reduction from current energy use by these buildings and is based on a set of assumptions, that are described in the appendix to ch. 2, about demolition of existing buildings and construction of new buildings needing retrofit. A quadrillion Btu equals approximately 500,000 barrels of oil per day for a year.

<sup>b</sup>The technical savings potential is defined as that resulting from all retrofits to these building types which as of 1981, are technically feasible and which would be cost effective over a 20-year lifetime, assuming no real increases in energy prices and a 3-percent real return on investment.

<sup>c</sup>Likely savings are those which are likely to come about from investments by building owners under current conditions of availability of capital, retrofit information, and public programs.

SOURCE: Office of Technology Assessment

## BUILDING BY BUILDING RETROFIT POTENTIAL

### Technical Description

The national potential (estimated in table 1) for increased energy efficiency of the building stock is the result of physical changes to improve the energy efficiency of millions of buildings. For convenience, these physical changes are referred to as energy retrofits in this report. While recognizing that each building is to some extent a unique problem, OTA did identify the major characteristics of buildings which influence the types of energy retrofits that are likely to be most effective. These are:

- **Size.**—Energy retrofits which improve the energy efficiency of the building envelope (walls, windows, and roof) are more important for small buildings than for large buildings. On the other hand, certain kinds of retrofits which bring about similar savings in small buildings and large buildings will cost relatively less per unit of energy saved in large buildings because of economies of scale.
- **Wall and roof type.**—Masonry or curtain walls and flat roofs without attics or with very small crawl spaces are much more difficult to insulate than are wood frame walls and roofs with attics and ample crawl spaces.
- **Mechanical system (HVAC) type.**—Physical changes to the way space heating or cooling is produced and circulated can provide significant increases in building efficiency but vary with the type of heating ventilation and air conditioning (HVAC) system used by the building.
- **Building use.**—Most commercial buildings are used from 9 to 5 on weekdays (offices) or 9 to 9 daily (shopping centers) and are unoccupied outside these hours. This provides opportunities for improved energy efficiency by careful control of temperature and lighting between operating and nonoperating hours. Opportunities also exist for more efficient and task-specific lighting in commercial buildings. Finally, retrofits to



m

m

g

g

g

m

g

the hot water system of multifamily buildings can usually save considerable energy.

### Capital Costs

OTA reduced 43 potential combinations of the four building characteristics described above to 13 building types for which the lists of appropriate retrofit options are distinct (although there may be considerable overlap among them). The 13 building types are shown in table 2, **OTA identified no major category of building typically found in cities for which substantial savings were not available from retrofits of low or moderate capital cost compared to savings.**

**For some of the building types, a major part of the potential savings are likely to come from retrofits of low capital cost compared to savings (see table 3) in the sense that they will pay for themselves in energy savings in 2 years or less and will earn real rates of return over the life of the retrofit (20 years on average) of more than so percent per year assuming no increase in the real cost of energy.** These building types include all small frame houses, moderate or large multifamily buildings with central air or

water mechanical systems, and all commercial buildings except the usually older commercial buildings with water or steam heating systems and window air-conditioners. Clearly the problem of financing retrofits for these buildings should be minimized by the fast payback (and high return) of their retrofit options. Some of these fast payback retrofit options include wall insulation in frame buildings, economizer cycles which make greater use of outside air for air-conditioning in commercial buildings and hot water flow restrictors in multifamily buildings.

**For all of the remaining building types, on the other hand, substantial savings are more likely to come from retrofit options of moderate capital cost compared to savings, which will payback in 2 to 7 years and whose real rate of return can range from as high as 50 percent to as low as 13 percent per year over a 20-year retrofit life** (also see table 3). These building types include all small masonry rowhouses, moderate or large multifamily buildings with decentralized heating and cooling systems, and older commercial buildings with water or steam systems and window air-conditioners. For owners of such buildings there may be significant

**Table 2.—Thirteen Types of Buildings With Significantly Different Retrofit Options**

| Building type and wall type                                    | Mechanical system type            | Retrofit options predominantly |                                    |
|--|-----------------------------------|--------------------------------|------------------------------------|
|  |                                   | Low capital Cost <sup>a</sup>  | Moderate capital cost <sup>a</sup> |
| Small house with frame walls (single family or 2-4 units)      | Central air system                | X                              |                                    |
| Same   | Central water system <sup>b</sup> | X                              |                                    |
| Same   | Decentralized system              | X                              |                                    |
| Small rowhouse with masonry walls (single family or 2-4 units) | Central air system                |                                | X                                  |
| Same   | Central water system              |                                | X                                  |
| Same   | Decentralized system              |                                | X                                  |
| Moderate or large multifamily building (masonry or clad walls) | Central air system                | X                              |                                    |
| Same   | Central water system              | X                              |                                    |
| Same   | Decentralized system              |                                | X                                  |
| Moderate or large commercial building (masonry or clad walls)  | Central air system                | X                              |                                    |
| Same   | Central water system              |                                | x                                  |
| Same   | Complex reheat system             | x                              |                                    |
| Same   | Decentralized system              | x                              |                                    |

<sup>a</sup>See table 3 for a definition.

<sup>b</sup>OTA's assumption is that this building type has a central water system and window air-conditioners.

SOURCE: Office of Technology Assessment.

**Table 3.—Three Ways to Express the Relative Cost Effectiveness of Energy Retrofits**

| Relative capital cost <sup>a</sup>                      | Simple pay back <sup>b</sup> (in years) | Annual real return on investment (percent) |
|---|---|--|
| Low capital cost <sup>d</sup> . . . . .                 | Less than 2 years                       | More than 50% per year                     |
| Moderate capital cost <sup>e</sup> . . . . .            | 2 to 7 years                            | 13 to 50% per year                         |
| High capital cost <sup>f</sup> . . . . .                | 7 to 15 years                           | 3 to 13% per year                          |
| Cost of retrofit exceeds savings <sup>g</sup> . . . . . | More than 15 years                      | Less than 3% per year                      |

<sup>a</sup>See ch. 3 for a full definition. Low capital cost is defined as less than \$14.00 per annual million Btu saved. Moderate capital cost is defined as \$14.00 to \$49.00 per annual million Btu saved. High capital cost is defined as \$49.00 to \$105.00 per annual million Btu saved. In all OTA's calculations in ch. 3, all electricity savings are multiplied by 2.46 to reflect the higher cost of electricity.

<sup>b</sup>Number of years for value of first year's energy savings to equal retrofit costs. Assumes value of energy savings is \$7.00 per million Btu (approximately equal to the average price of distillate fuel oil in 1960).

<sup>c</sup>Annual real discount rate that equates costs and savings over a 20-year measure lifetime. This assumes that fuel savings escalate at the same rate as inflation.

<sup>d</sup>Compared to savings.

<sup>e</sup>Not cost effective.

SOURCE: Office of Technology Assessment,

and annual real rates of return of less than 13 percent per year (over 20 years). If lifecycle costing is used, such retrofits may in fact be less expensive over the full life of the measure of the cost of the energy they would save. However, their very slow payback and low annual rate of return create serious financing obstacles. **For most of the building types OTA examined, such high cost retrofits would save no more than 20 percent of the full technical savings potential.** The three exceptions and the estimated percentage of total savings from high cost retrofits are:

- Masonry rowhouse with a heating system using air (40 percent).
- Masonry rowhouse with a water or steam system (25 percent).
- Large multifamily building with an air system (30 percent).

Examples of some high cost retrofits which produce substantial savings in certain building types include: wall insulation in masonry rowhouses and multifamily buildings and night-time window quilts in multifamily buildings.

### Importance of Solar Retrofits

Passive and active solar system retrofits can reduce the energy requirements for space heating and hot water just as nonsolar energy retrofits can. OTA compared costs and energy savings of seven different kinds of solar retrofits to



Photo credit, Department of Housing and Urban Development

Single-family detached framehouses supply more than half of all housing in U.S. Central cities

problems of financing substantial energy retrofits. Some examples of effective retrofits with moderate capital cost include: roof insulation and storm windows for masonry rowhouses, hot water heat pumps for multifamily buildings with decentralized systems, and replacing low efficiency window air-conditioners with more efficient models.

**For most of the building types there are also retrofit options of high capital cost compared to savings with paybacks of longer than 7 years**



Photo credit, Department of Housing and Urban Development

Adding wall insulation to masonry rowhouses saves substantial energy but is of high capital cost compared to savings

small and large residential building types. Many solar retrofits are of high capital cost (slow payback and low return on investment); a few are of moderate capital cost and none are of low capital cost. For all building types and retrofits examined there are nonsolar energy retrofits which save as much and cost the same or less, if **3.**

chosen strictly on the basis of capital cost and effectiveness, the nonsolar retrofits would probably be chosen first, although there are many reasons including aesthetic ones for choosing solar retrofits. Some cost-effective solar retrofits on some building types are identified in chapter

## DIFFICULTY OF PREDICTING THE OUTCOME OF A RETROFIT TO A PARTICULAR BUILDING

While the general prospects for cost-effective retrofit are good they may be very unpredictable for particular buildings. Extensive research and applied work on the retrofit of buildings to improve energy efficiency has only been underway for the past few years and most of this work has focused on single-family housing. **There are little data on the actual effects of building retrofits, and for some types of buildings there are almost no data.** Few energy auditors or building owners have maintained and made available careful records of preaudit fuel consumption, cost and type of retrofit, and postretrofit performance. A recent compilation of data on actual retrofits of commercial and larger multifamily buildings (see ch. 3) included data on **222** buildings. Among these, there was only one multifamily building, one shopping center, and four hotels. Most of the rest were schools and office buildings. **These data on actual retrofits confirm that, on average, considerable savings are possible from low and moderate cost retrofits.** For almost 90 percent of the buildings surveyed with good cost data available, the cost of the retrofit package installed paid back in energy savings in 3 years or less.

**However, actual savings may be considerably higher or considerably lower than predicted for individual buildings.** For the 60 buildings with data on savings predicted by an audit as well as actual savings achieved by the retrofit, actual savings varied in both directions (more than predicted and less than predicted) by a wide margin. For a group of 18 similar community centers, for example, actual energy savings averaged 85 percent of the predicted amount but varied (within one standard devia-

tion) from 50 percent more than predicted to **80** percent less than predicted. Such results are only suggestive. Carefully designed data collection would be necessary to estimate more accurately the predictability of energy savings from different combinations of retrofit measures. The available data, however, are consistent with OTA's finding that there are inherent characteristics of building retrofit which are responsible for the substantial variation of likely savings from a particular retrofit from the predicted value. The variability can be reduced from its present level but it will probably remain substantially above zero.

**Each structure is a unique combination of design, siting, construction, and previous retrofits. The behavior of the building occupants and the climate will also affect energy savings in unpredictable ways. These factors make it difficult to gather consistent data to determine the actual (compared to the theoretical) results of retrofit.** Buildings with the same generic design will use energy differently due to the location of the structure in relation to the Sun. Further, buildings tend to vary in construction, even given the same design. Substantial amounts of energy can be lost through openings in interior walls, through leaky duct systems, and in other ways not obvious to the observer.

While there are methods commonly used to calculate heating loads, cooling loads, and other factors, these formulas best apply to a controlled situation rather than a real structure. As each energy retrofit is added to a structure, the system is changed, and very little is known



about how to predict the interaction of several retrofits on a given building. Differences from building to building in the number of occupants and their living and working patterns (e.g., open windows v. air-conditioning) complicate the issue. In addition to behavior, microclimates and yearly weather changes will affect the actual amount of energy used. Thus, a researcher trying to figure out the real building energy use in a multifamily structure needs to know vacancy rate and local weather conditions that year as well as fuel use. Not all data are corrected for climate, and not all climate correction techniques are the same. It is even less common for data to be corrected for occupancy. The variation in data adds to uncertainty.

**In many buildings increased energy efficiency depends heavily on building operation and maintenance.** Some of the buildings described in the survey above failed to save as much energy as predicted because of poor performance by the equipment operator. For larger buildings, systematic improvements in operation and maintenance are likely to save as much or more energy as capital investment. An energy auditor can recommend these changes in practice but they are not permanent improvements and will affect the degree to which actual savings match predicted savings.

## WILL OWNERS OF CITY BUILDINGS INVEST IN THE ENERGY EFFICIENCY OF THEIR BUILDINGS?

Given an investment with a probable high return but a possibility of partial or complete failure (as well as a possibility of greater-than-expected success), how are the owners of buildings in cities likely to respond to the opportunities to increase the energy efficiency of their buildings?

**Energy is now important.** After many years of energy price increases the cost of energy is now sufficiently important for building owners in the balance of income and expense of their buildings that steps have to be taken to control it. This is a change from general building owner opinion of several years ago.

**Several categories of building owners with good access to equity capital, reliable professional advice on retrofits and a long holding strategy for their buildings are retrofitting their buildings and installing retrofits of low and moderate capital cost compared to savings.** Institutional owners of buildings, such as insurance companies and pension plans, have set energy efficiency goals for their property managers and routinely make capital investments in energy efficiency if they will pay back in less than 5 to 7 years (see table 4). Large corporations which generally occupy any buildings they

own also install retrofits with moderately long expected paybacks (3 to 5 years). Nationally syndicated partnerships also have generous payback criteria.

**Several other categories of building owners with access only to debt financing and tight constraints on the building's cash flow are only installing the most cost-effective retrofits in their buildings.** Small business owner-occupants and owner-occupants of multifamily buildings expect to hold their buildings for a long time and would benefit from retrofit, but they are severely constrained by lack of access to capital and generally cannot tolerate losses in cash flow. Individual and small partnership investor-owners of buildings require that energy retrofits pay back in 1 to 2 years. They have poor access to equity capital and poor access to professional advice.

**The prospects for retrofit of commercial and multifamily buildings differ.** With the exception of flourishing markets in dynamic neighborhoods in such cities as Washington, D. C., and San Francisco, multifamily buildings have suffered as a group from lagging rents and therefore lagging resale value (except as condominiums) that reduces their likelihood of retrofit

**Table 4.—Retrofit Payback Criteria, Holding Periods and Access to Financing, and Advice for Different Types of Owners**

| Building owner type                   | Typical payback criteria | Building for own use? | Expected holding period | Access to capital | In house professional advice |
|---------------------------------------|--------------------------|-----------------------|-------------------------|-------------------|------------------------------|
| <b>Owner-occupants</b>                |                          |                       |                         |                   |                              |
| Large corporations . . . . .          | 3-5 years                | Yes                   | Long                    | Good              | Good                         |
| Small businesses . . . . .            | 1 year                   | Yes                   | Long                    | Poor              | Poor                         |
| Multifamily owner-occupants . . . . . | 1-3 years                | Yes                   | Long                    | Poor              | Poor                         |
| Condominium . . . . .                 | No Data                  | Yes                   | Long                    | Mixed             | Fair                         |
| <b>Investor-owners</b>                |                          |                       |                         |                   |                              |
| Institutional owners . . . . .        | 5-7 years                | No                    | Long                    | Good              | Good                         |
| Development companies . . . . .       | 1-3 years                | No                    | Short                   | Fair              | Good                         |
| Partnership syndicates . . . . .      | 3 years                  | No                    | Short                   | Fair              | Good                         |
| Local partnerships . . . . .          | 1-2 years                | No                    | Short                   | Poor              | Fair                         |
| Individuals . . . . .                 | 1 year                   | No                    | Mixed                   | Poor              | Poor                         |

NOTE Long holding period = more than 10 years Short holding period = 8 to 10 years

SOURCE Office of Technology Assessment.



Photo credit. Department of Housing and Urban Development

Net and passthrough leases reduce the incentives of owners of small retail and office buildings to retrofit their buildings

below that of commercial buildings owned by the same owner. Where technically possible, owners of multifamily buildings have converted them to tenant utility meters so that owners will no longer be responsible for paying the utility costs. Owners of tenant-metered buildings have little or no current incentive to retrofit their buildings. Most believe that it will be a long time before owners of energy efficient multifamily buildings can charge higher rents than owners of similar but inefficient buildings.

The most likely buildings to be retrofit are office buildings, hotels, and department stores owned by a large corporation or institutional owner. The least likely to be retrofit are tenant-metered multifamily buildings owned by individuals or local partnerships.

### Why Do Some Owners Forego the Large Potential Returns on Retrofit?

Most individual owners and many partnership owners will not invest in energy retrofits even if they payback in as short a period as 2 or 3 years. This unwillingness occurs despite the fact that a retrofit package with a 3-year payback will generate a very large return on investment—more than 33 percent real return per year—over a 20-year life of a retrofit installation.

### High Cost of Finance

Much of real estate, including major development companies, is financed by debt not equity. In the terms of the industry, equity is “highly leveraged.” A major portion of the financing for purchase of a new or existing building almost always comes from a mortgage. Additional financing for expansion, rehabilitation, repair, or retrofit of a building has traditionally come from refinancing a building with a new bigger mortgage at a similar rate of interest as the original mortgage. The recent increase in interest rates has effectively eliminated that option for most building owners. No one is likely to refinance a 7-, 9-, or 11-percent mortgage at 14- to 17-percent interest in order to get funds for rehabilitation or retrofit. The primary source of funds other than mortgages for building owners is a commercial loan. These are generally 18- or

24-month high-interest loans used for financing construction projects. During much of 1980 such loans were only available at variable interest rates 2 percentage points above the prime rate.

**A building owner, unable to tolerate much reduction in the cash flow from a building, cannot manage anything but a retrofit with a very fast payback if his only financing option is a short-term high-interest loan.** Figure 1 illustrates this clearly. A 2-year payback retrofit will generate more energy savings than it will cost in debt service, even at 22-percent interest, if it is financed with a 3-year loan or longer. A 5-year payback retrofit, on the other hand, will cost more the first year in debt service than it will generate in energy savings unless it is financed for at least 10 years at interest rates of 10 or 13 percent, or for 20 years at an interest rate of 16 percent. \*

### Impact of Risk

**The problems faced by a building owner forced to finance a retrofit with short-term, high-cost debt are made much more serious by the uncertainty of the return on retrofit for his particular building, even though, on the average, the general prospects for retrofit are good.** Based on the limited information cited earlier on the accuracy of audits, it is possible that savings from a retrofit could be 50 and even 70 percent below those predicted by an audit. (There is an equal likelihood that actual savings will be above predicted.) A predicted 3-year payback retrofit will turn into a 6-year payback retrofit if actual savings are 50 percent below the prediction, and it will turn into a 10-year payback retrofit if savings are 70 percent below what is predicted.

| Extent of savings                | First-year savings from a \$10,000 loan | Payback (in years) |
|----------------------------------|---|--------------------|
| Predicted by an audit.....       | \$3,300                                 | 3                  |
| 50 percent below prediction..... | \$1,650                                 | 6                  |
| 70 percent below prediction..... | 990                                     | 10                 |

\*In years after the first year, inflation in energy costs (even if no faster than general inflation) will increase the value of energy savings relative to debt service. If energy costs increase at the rate of inflation, they will increase in current dollars and will be constant in real 1972 dollars, while fixed annual debt service payments are constant in current dollars and decrease in real 1972 dollars over time. Thus, any debt service payment in excess of fuel savings will diminish over time.

**Figure 1.—Combinations of Loan Terms and Interest Rates Which Allow the Value of Energy Savings to Exceed the Cost of Borrowed Money the First Year**

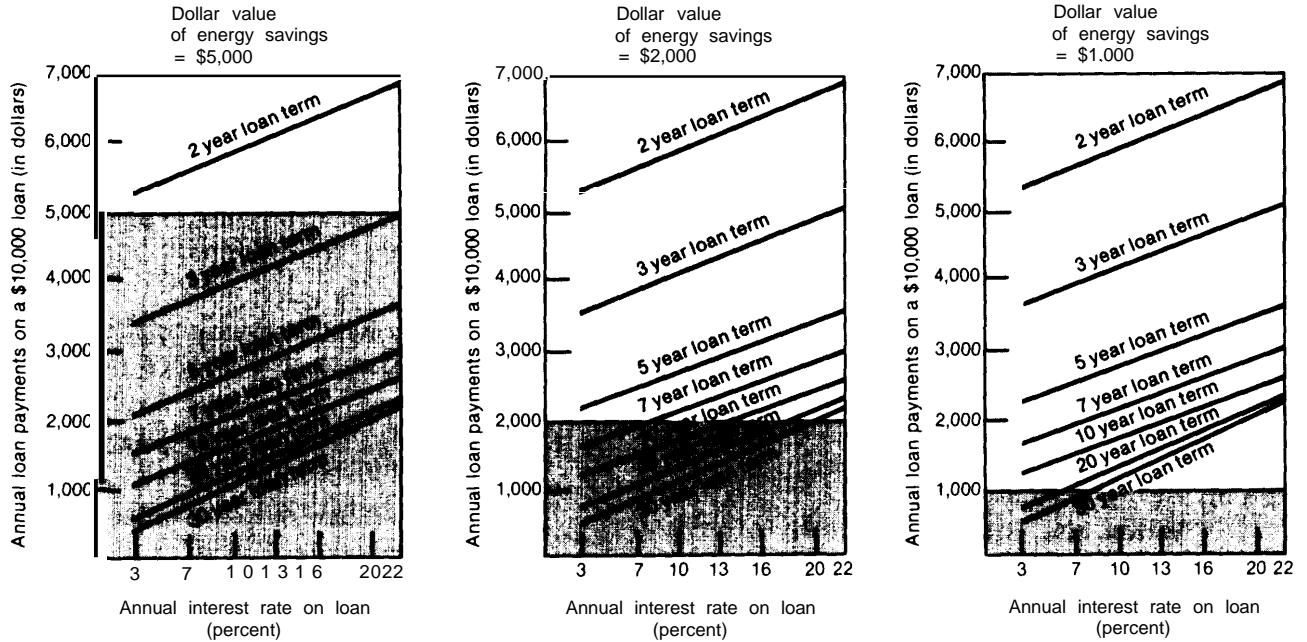

Case 1 : Energy savings from a 2 year payback retrofit (maximum payback considered by an individual or local partnership owner)

Case 2: Energy savings from a 5 year payback retrofit (criteria used by corporations, insurance company owners)

Case 3: Energy savings from a 10 year payback retrofit (maximum payback criteria of any owner interviewed)

Key:

Cash flow loss the first year

 Cash flow *increase* the first year

SOURCE: Office of Technology Assessment

it would be devastating, especially to many small business owners, or investor-owners of multifamily buildings, to carry the debt service for a major retrofit and fail to achieve the energy savings necessary to keep their cash flow up. Yet this is a realistic possibility given both the newness of the retrofit business and the individual nature of building energy performance.

### The Impact of Two Forms of Subsidies: Lower Financing Costs and Tax Credits

Until interest rates drop, various subsidies from public sources or private sources such as utilities may be helpful. OTA analyzed some

hypothetical multifamily buildings to determine whether a tax credit\* or a financing subsidy might increase the ease of doing a retrofit and concluded from this analysis that a financing subsidy is more helpful in making retrofits possible and less expensive than a tax credit. The beneficial impact of a financing subsidy is greatest for a hypothetical low-rent high energy cost building typical of the low-rent end of the multifamily market. An unsubsidized retrofit

\*It should be remembered that a tax credit for energy retrofit is only one of several tax provisions that affect energy use and energy retrofit. Energy expenses are fully deductible as a business expense, while Investments In energy retrofit can be partly deductible through deductions of interest rates and depreciation.

loan (16 percent interest for 5 years) for a 6-year payback retrofit virtually wipes out the cash flow of this building.

A subsidy of approximately 15 percent to lower the interest rate and extend the loan term (13 percent interest for 10 years) restores the cash flow of the building immediately and increases it noticeably by the fifth year following the retrofit. (This analysis of hypothetical multifamily buildings is described in ch. 4.) Of the building owners interviewed, two-thirds preferred a financing subsidy to a tax credit. The one-third that preferred a tax credit included some partnerships that welcomed increased tax shelters, and also included some corporations that had adequate internal sources of finance but would benefit from a tax shelter.

### When the Building Owner Is the Government

Energy use in buildings owned by local, State, or Federal government is significant. About 0.5 Quad of energy was used by public buildings in 1980 and about 1.5 Quads in educational buildings, most of which are publicly owned. Much like the corporate or large institutional owner, governments and school districts have annual formal budgeting procedures which identify the importance of energy cost increases and compare them from year to year. Governments and school districts have professional general property management department and often at least part-time energy advisors.

Unlike the corporate or large institutional owner, on the other hand, government owners of buildings have severe constraints on access to capital due to constraints on annual budgets and many kinds of limits on bonding authority. The result (see ch. 9) is that government owners of buildings often implement effective operating programs of improved maintenance and energy conservation practices by building occupants but restrict their capital investment in buildings to retrofits with 1 to 2 years payback. Only if the retrofit can be linked to other major repairs (such as roof insulation with new roofs) or if paid for by a Federal grant, are longer payback periods allowed.

### General Prospects for Retrofit of Buildings in Cities

Public programs and private campaigns to market increased energy retrofits of buildings must take into account the variety of motivations of building owners. Owners not likely to retrofit their buildings either lack financial reason to do so, lack feasible means to do so, or both. The implications for public policy and private marketing are different for each category.

The category of owners willing and able to retrofit (labeled category A in table 5) do not need

**Table 5.—Owners Likely and Not Likely to Retrofit Their Buildings**

| Owners' access to finance and tolerance of risk | Importance of reducing energy costs to owner's goals  |  |
|---|---|--|
|   | Important   | Not Important  |
| Owner can both finance and absorb risk          | <b>A. Willing and able to retrofit</b> <ul style="list-style-type: none"> <li>• Corporate owner-occupants of commercial buildings</li> <li>• Institutional investor-owners of commercial and multifamily buildings</li> </ul>   | <b>B. Able but unwilling</b> <ul style="list-style-type: none"> <li>• Large partnership owners of tenant-metered multifamily buildings</li> <li>• Well-financed owners of office buildings and retail buildings in tight, energy-insensitive markets (large partnerships and development companies)</li> </ul>   |
|   | <b>C. Willing but not able</b> <ul style="list-style-type: none"> <li>• Owner-occupants of small multifamily buildings</li> <li>• Small business owner-occupants</li> <li>• Individual and small partnership owners of master-metered multifamily buildings</li> <li>• Individual and small partnership owners of office buildings in energy-sensitive markets</li> <li>• Government owners of buildings</li> </ul> | <b>D. Unwilling and unable</b> <ul style="list-style-type: none"> <li>• Individual and small partnership owners of tenant-metered multifamily buildings</li> <li>• Individual and small partnership owners of office or retail buildings with net or pass-through leases in energy-insensitive markets</li> <li>• Owners of buildings in marginal areas</li> </ul> |

SOURCE: Office of Technology Assessment,

any additional public incentives to retrofit. Many are prime targets for private marketing efforts by companies that specify and/or install retrofit products. Category B is able but unwilling to retrofit. This category of owners would be expected to respond to increased requirement for energy efficiency in existing buildings. If required, they would have the means to carry out the retrofit.

Those owners that are willing and even anxious to retrofit but lack access to low-cost finance and good technical advice and cannot to/crate risk are labeled category C in table 5. These owners would be prime targets for marketing by successful private companies organized to put up capital and absorb the risk of retrofit. These owners are also likely to respond to public programs that reduce financing costs and lower the risk of retrofit.

The most difficult to motivate are the owners in category D for they are both *unwilling and* unable to retrofit. If local governments choose to require them to invest in the energy efficiency of their buildings (through an energy efficiency code for existing multifamily buildings, for example) local government must also see to it that financing of at least moderately long terms is available, or these owners will not be able to comply with the requirement. Owners of buildings in marginal areas are unwilling to invest in their buildings unless they believe the neighborhood is viable enough to recoup their invest-

ment in the resale value of the building. For such owners, an energy retrofit program is best folded into a general neighborhood rehabilitation program which combines concentrated private investment in one neighborhood with such public investment as improved sidewalks, storm sewers, and tree planting.

There are insufficient data on either the physical nature of the building stock or patterns of ownership to allow anything but very rough estimates of the amount of energy that might be saved by each of these categories of owners. OTA estimates that about 1 Quad of the 4-Quad gap in foregone energy efficiency retrofits is attributable to multifamily and commercial building owners that are willing but unable to retrofit because they lack financing and/or access to reliable information. Another 1.5 Quads of the foregone retrofits would be due to building owners that were unwilling to retrofit their buildings because they could see insufficient advantage in doing so. About two-thirds of these owners also lack access to financing or professional advice.

The rest of the estimated 4 Quads of foregone retrofits would result from moderate and upper income homeowners in cities unable or unwilling to finance retrofits of moderate and high capital cost compared to savings (about 1 Quad) and low-income homeowners (regardless of location) unable to finance any retrofits (about 0.5 Quad).

## PROSPECTS FOR DISTRICT HEATING

District heating is a system for piping heat in the form of hot water (or steam) from a central source of heat to individual buildings. Under the right conditions a well-managed district heating system may be an energy efficient way of supplying heat to city buildings.

From a national energy perspective, district heating offers an opportunity to save fuel oil or natural gas by making use of the waste heat from electricity generation for space and water heating. Hot water district heating has been widely and successfully introduced in Northern

Europe over the past three decades. District heat also offers an opportunity to shift from premium fuels such as natural gas and distillates to coal or renewable resources (including municipal solid waste) for supplying heat to buildings. To building owners who are district heating customers, it promises slower increases in energy prices. For local governments, district heating can be a tool in the overall task of economic development since it uses local workers for construction and operation, helps attract new development to central city locations, and helps to stabilize energy prices for existing buildings.

For all the possible advantages of district heating, however, the design, approval, construction, and successful operation of a district heating system is a formidable undertaking whose complexity and difficulty should not be underestimated. To be successful, a district heating system must offer heat at prices that are low enough to persuade owners of existing buildings to abandon their buildings' natural gas or fuel oil boilers or furnaces, retrofit their buildings to accept the hot water (or steam) from the district heating system and continue to purchase the district heat through the life of the system. Or the system must persuade owners of new buildings of the long-term advantages of foregoing the cost of their own heating system and equipping their buildings to take district heat rather than burn fuel directly.

If general interest rates lower substantially or a substantial financing subsidy is made available, hot water district heating could become a sensible long-term investment that stabilizes fuel prices costs over the long run in one or two dozen U.S. cities. **At current high interest rates and without special subsidies, large-scale district heating may be feasible for those few U.S. cities with dense areas of customers using expensive fuel oil, and a long enough heating season to make possible a reasonably high use of district heating capacity.** This number is less than five and may even be zero. However, small district heating systems for a small number of large buildings located close together may be feasible even at current high interest rates.

## PROSPECTS FOR PRIVATE SECTOR MARKETING OF ENERGY RETROFITS

In theory, there should be ample opportunity for private businesses to fill the gap between the large potential return on investment in energy efficiency and the slow pace of retrofit among some types of buildings. Businesses willing to provide the capital over a long term and willing to absorb all or part of the risks of retrofits to individual buildings ought to be able to realize part of that return.

Investors could lease energy efficient equipment to building owners and claim the tax benefits for themselves. They could install energy efficiency measures and provide energy savings guarantees to building owners. Or they could take over responsibility for the energy costs of a building as energy management companies. In the latter case the investors, in return for a monthly energy management fee, would install energy efficient equipment and assume all responsibility for paying utilities.

**In practice OTA was able to identify only a handful of enterprises providing retrofit cap-**

**ital or absorbing the risk of retrofit.** In part this is the result of the general difficulties encountered by all new businesses in a time of high interest rates. Energy retrofit enterprises, however, also face several special problems. It is difficult to predict accurately energy savings from specific energy efficiency investments partly because much retrofit technology has not yet been installed in many buildings. It can be difficult to come to a legally viable agreement on what constitutes energy savings given variations in energy use caused by changes in weather, occupancy of a building, and occupant behavior. It can be difficult to agree on a definition of the equipment to secure the investment since much energy efficient equipment becomes part of the building it is installed in.

OTA was also able to identify only a few co-ops and nonprofit corporations involved in the retrofit of buildings. Co-ops and nonprofit corporations are hampered by lack of capital and the difficulties of managing a large-scale retrofit program.

## WILL GAS AND ELECTRIC UTILITIES STIMULATE INVESTMENT IN ENERGY RETROFITS?

Rapid deterioration in the financial health and future prospects for many electric and gas utilities have created more than token interest in developing energy retrofit programs. Customers are increasingly vocal against utility rate increases at rate hearings. In response to increased prices, customer demand for electricity and gas has grown more slowly than forecast a decade ago and in some utility areas has actually declined. In an era of growth in interest costs and inflation in construction and fuel costs, lags in utility ratemaking have led to utilities earning less than the designated rate of return. In response to many of these problems, some utilities have developed energy efficiency improvement programs either to improve relations with customers, earn a greater return, or both.

Some utilities have energy retrofit programs in response to directives by their State regulatory commissions (e.g., Florida, New York, and California) and others developed energy audit programs on their own. In all, about 65 utilities offered residential energy audits as of the winter of 1977-78 before the Federal Residential Conservation Service (RCS) program was announced. Even if such audit programs are no longer mandated by the Federal Government under the RCS, many utilities are likely to continue them. Customer demand for utility audits, however, is likely to remain limited unless the utility markets audits vigorously with an eye to achieving measurable energy conservation goals.

A few electric utilities have built energy retrofit programs into their projections for future generating capacity and have deliberately ex-

changed planned new capacity for planned curtailment of demand. The New England Electric System (**NEES**) for example has announced a program to assist in the retrofit of commercial buildings for load management, thus reducing the need for new peak generating capacity. As now structured, the NEES program would not affect residential buildings much at all.

Theoretically, both slow-growing utilities, like NEES, which have time to plan and assess conservation, and fast-growing utilities, such as those in Florida who have to try everything to avoid falling short of meeting demand, could build energy retrofit programs into their strategic planning. In practice, utilities who do this must have the innovative leadership to develop new products, new marketing techniques, new customer relations, and new forecasting and monitoring techniques. **In a period when utilities are struggling against very difficult financial problems, OTA concluded that few may develop the leadership to undertake ambitious large-scale energy retrofit programs on their own.** A larger number of utilities may be willing to cooperate with State governments that are promoting energy retrofit programs as in Florida and California. As electric utilities become increasingly interconnected across State boundaries, there could be a role for the Federal Government in encouraging cooperation among State utility regulatory commissions as they integrate conservation goals and planned new electric generating capacity. Utilities, however, will continue to look to the State ratemaking process for encouragement or discouragement of conservation programs since State level ratemaking determines utility return.

## PUBLIC SECTOR PROGRAMS TO STIMULATE ENERGY RETROFITS

### Potential Role of City Governments in Urban Building Retrofit

**A few visionary leaders in a few cities have created a link between the energy retrofit of**

**local buildings and such broad goals as the long-term viability of the housing stock, and the long-term stability of regional income and economic productivity.** They have promoted this view in speeches and reports and encour-



aged citizens to be aware of energy and its role in the city or region.

**In most cities, however, citizens' worry about rising energy costs has been more directed at the local utilities, and mayors and city councils feel little pressure in city hall to do anything directly about energy.** Most cities

do not have active energy programs. Only 5 percent have full-time energy coordinators; most of the part-time energy coordinators spend less than 1 day a week on energy. The primary energy concern of most mayors and formally designated city energy coordinators is to reduce the growing share of energy cost in the cities budgets.

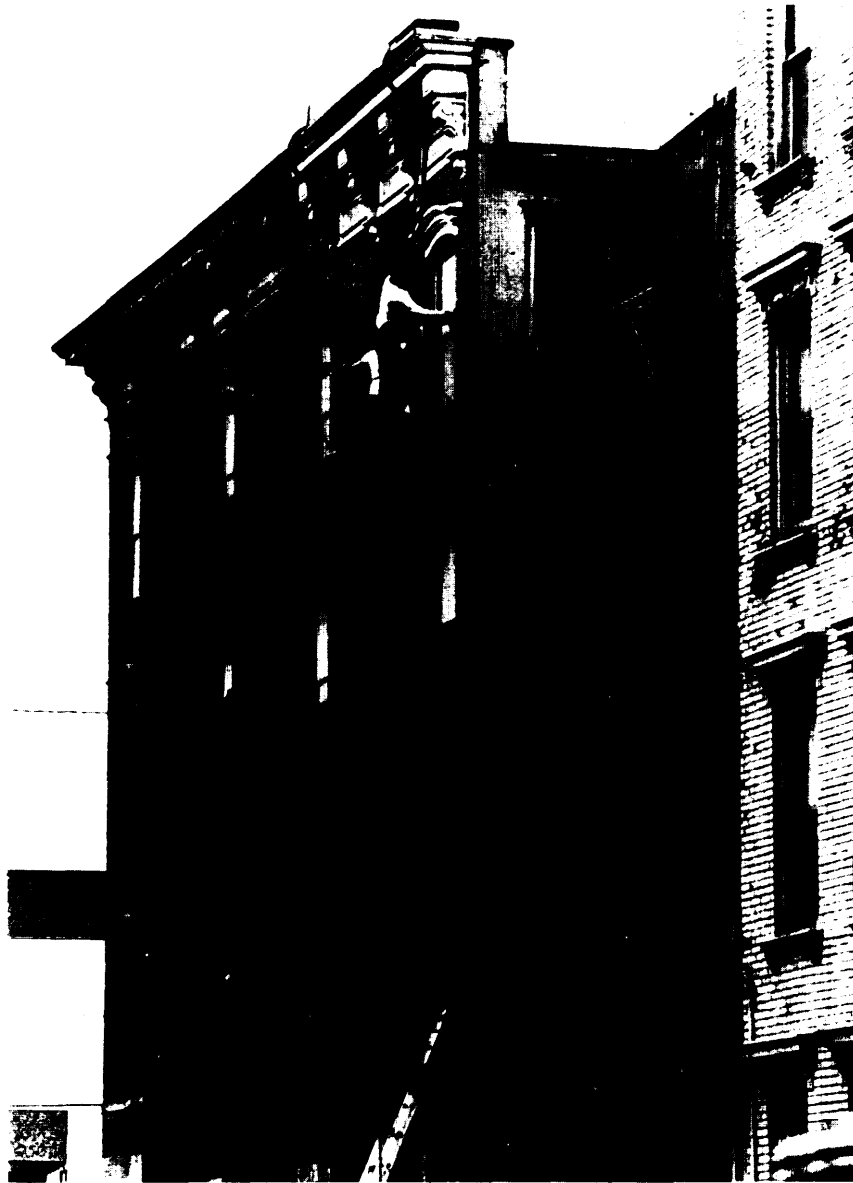

Photo credit: OTA staff

For many cities, energy retrofit programs fit best in the context of programs to promote general housing rehabilitation

For some cities energy problems do reach city hall in the form of complaints about landlords' failure to provide adequate heat. In New York City, for example, the number of such complaints increased from **225,000** in 1978-79 to **320,000** in 1980-81. In cities where a metropolitan oversupply of housing softens the market for rental housing in the center city, the rapid increase in energy costs is sometimes perceived as a trigger for landlord abandonment of buildings. Such abandonment has been reported as severe in such smaller cities as Rochester, N.Y., and Springfield, Mass.

Many cities have incorporated energy retrofit into their housing rehabilitation programs. These are usually financed by Federal community development block grants (CDBG) or other housing rehabilitation funds. Linking retrofit to general housing rehabilitation has two advantages. It makes possible general repairs in roof or windows that are needed to make the energy efficiency measures work. It also addresses the concern of property owners confronting a retrofit investment that the building as a whole has resale value and that the neighborhood it is located in be economically stable. Housing rehabilitation programs in cities generally proceed neighborhood by neighborhood, often combining support for private rehabilitation with expenditures on such public works as sidewalks. **A program that promotes energy retrofit in the context of general property upgrading fits well with city government concern for the general health of the housing stock and the property tax base.**

Cities have other ways to promote building retrofit besides their housing rehabilitation programs. They may promulgate energy efficiency building standards at time of sale (Portland), issue municipal bonds to subsidize private retrofit expenditures (Minneapolis and Baltimore), or manage Federal weatherization directly and vigorously (Des Moines) rather than allow it to be administered by local nonprofit antipoverty agencies.

## Potential Role of State Governments in Urban Building Retrofit

**Some States have active energy audit or retrofit programs with potentially far-reaching results.** Florida and California typify one source of motivation for States. Both States have rapidly growing populations and projected requirements for continued expansion of electrical generating capacity. Both States have difficulty finding large number of sites for new powerplants. Although their climates are mild and yearly energy bills lower than States with colder climates, both States face certain increases in natural gas prices and possible sharp increases in electricity prices if powerplant capacity must be added very fast. Florida and California have both required that utilities develop extensive energy audit programs, linked to slowdowns in construction of new generating capacity.

New York, Minnesota, and Massachusetts on the other hand have slowly growing or stable populations, State officials are not concerned about utility construction plans since utilities in these States are likely to face economic problems caused by excess generating capacity rather than the need to construct new generating capacity. Rather, State officials are motivated by concern about the health of the housing stock and hardship caused by the combination of high energy prices and severe winters.

States seeking to bring about large-scale retrofit have several possible tools to use. They may require high-powered utility audit programs (generally using the framework of the Federal RCS audit program), bring effective management to bear on the Federal weatherization program (Pennsylvania), require energy efficiency building code standards for new or existing buildings (Minnesota), or occasionally provide their own subsidized financing for energy retrofit (New Jersey).

**For every State, however, which has developed programs to stimulate building retrofit, there are many States with similar concerns**

**which have not developed active retrofit programs.** Like cities, States have many other demands on their economic and managerial re-

sources. Thus, State stimulus of building retrofit is likely to remain uneven, strong in some States and weak or nonexistent in others.

## THE FUTURE: FEDERAL POLICY OPTIONS FOR STIMULATING THE RETROFIT OF BUILDINGS IN CITIES

Many programs developed or implemented by States and local government actually originated with the Federal Government. After 7 years of steadily increasing Federal involvement in energy conservation since the 1973 oil embargo, a basic shift in emphasis is now underway. All but a few of the Federal energy conservation programs have been substantially reduced in the 1982 budget.

The current debates about the proper role of the Federal Government in energy conservation, housing and community development programs and assistance to the poor will affect the nature of the Federal role in stimulating the retrofit of buildings in cities. The following discussion of the Federal options for stimulating building retrofit reflects the broad range of Federal roles advocated by different parties to the debate.

### Option A: No Intervention

The rationale for this option for the Federal role is that energy retrofit is best left to the private sector. If managerial and legal problems can be solved, a wide variety of innovative technical and financial approaches will be developed by the private sector over the next decade to take advantage of the investment opportunities presented by retrofit. Efforts to reduce the high risk of retrofit by more accurate documentation of energy savings will eventually be better undertaken by trade associations and other private organizations with a stake in the results than they would be by the Federal or other levels of government.

Under this option, State governments and city governments would be free to develop energy retrofit programs of their own: States, as part of their regulation of public utilities; cities, as part

of community development programs. Federal efforts to stabilize the economy, to allow accurate energy price signals and to lower interest rates are viewed as the only legitimate Federal role in accelerating retrofit opportunities.

### Option B: Small Federal Market Assistance Role

Under this view, the private market must be assisted by the Federal Government because there is a strong national interest in higher energy efficiency, and because it is possible that the private market, by itself, is insufficient to satisfy national need and to maximize economic efficiency. On the other hand, according to this view, constraints on the Federal budget are severe enough to prohibit all but a small Federal role.

Even with a fairly low budget, however, the Federal Government could develop a clearly focused research, development, and information program to reduce the risks of retrofit. Such a program is probably best modeled on private sector efforts in order to ensure maximum information exchange. Several restaurant chains have set up proprietary programs to test retrofits in different building types. Sears & Roebuck explicitly tested several kinds of retrofits in its stores before launching a multi million dollar retrofit program. An ongoing Department of Energy program to test retrofits to hotels and motels and disseminate the results through the American Hotel & Motel Association could be expanded to other trade associations and other building types. The most urgent need is to document retrofits within the multifamily building sector and publicize them through the several multifamily trade associations,

Small-scale Federal retrofit subsidy programs, such as the schools and hospitals program and the Solar and Conservation Bank (described in ch. 9) would have the most impact if used primarily to increase knowledge and reduce the risk of retrofit. Public housing modernization funds used for energy retrofit of public housing could also be used to document energy savings from energy retrofits. Under this approach, private building owners or public housing authorities receiving subsidies, would be asked to participate in a program to describe and document the results of the retrofit and disseminate it, through trade associations and chambers of commerce, to other building owners.

### Option C: Large Active Federal Role

This Federal role would be consistent with both an activist philosophy of government and the view that reducing U.S. energy use over the long run is an important national goal for reasons of national security, minimizing disruption to the environment and maximum economic growth and competitiveness. Under the rationale for a high budget Federal role, if energy retrofit is the path of least total cost and if it is not likely to come about because of the nature of the energy problem and private markets, then the Federal Government should encourage and subsidize energy retrofit to the point where the major part of the cost-effective retrofit actually occurs.

This Federal approach should first and foremost include the risk-reducing activities described in the low budget approach above. A reduction in the perceived risk of a retrofit is

essential if all building owners are to take advantage of a financing subsidy and make the investment. Vigorous promotion of State and utility development of audit programs for all building types and development of audit training programs would also, under this approach, help reduce the perceived risk of retrofit.

The Federal Government already provides a major financing subsidy to single-family homeowners in the form of a residential energy tax credit. About 4.8 million taxpayers used the credit in 1979 to make about \$3.5 billion worth of energy efficiency investments. The credit cost the Treasury about \$440 million. Multifamily building owners currently have no effective access to energy tax credits (although there is a narrowly defined business energy tax credit for improving the energy efficiency of industrial processes).

A new Federal effort to subsidize energy retrofit could either extend the energy tax credit to multifamily and commercial building owners or it could take the form of a program to subsidize interest rates and extend energy retrofit loan terms to such owners. OTA estimated the approximate size of a large-scale effort designed to produce 2 Quads of annual savings through retrofit at the end of 10 years. A subsidy used to lower annual interest rates by 2 to 3 percentage points and extend loan terms could subsidize about \$4 billion worth of retrofits per year at an annual cost of about \$600 million, a little more than the current cost to the Treasury of the residential energy tax credit (see table 6). (The assumptions behind this estimate are described in ch. 11.)

**Table 6.—Two Forms of Federal Subsidy**

| Subsidy type  | Cost per year | Energy impact  | Estimated value of savings (in dollars) |
|---|---------------|--|---|
| Subsidized \$40 billion in conventional loans over 10 years for energy retrofit                             | \$600 million | 2 Quads saved annually after 10 years  | \$14 billion to \$30 billion per year   |
| Ten district heating systems allowed to use tax-exempt financing (\$1.5 billion each), constructed 10 years | \$600 million | 0.3 Quad displaced annually from fuel oil or gas to coal, solid waste or waste heat (after 10 years) | \$1.2 billion per year                  |

SOURCE: Office of Technology Assessment

An active Federal approach might also include a financing subsidy for district heating, most conveniently by permitting tax-exempt bonds in magnitudes greater than the currently allowed \$10 million. A subsidy to permit 10 systems of \$1.5 billion each in 10 cities is likely to cost annually about 4 to 5 percent of the system (in foregone taxes on tax-free bonds). The 10 systems could be expected to displace about one-third of a Quad of fuel oil or natural gas and substitute coal, heat from solid waste or waste heat from electricity generation.

Two Quads of energy savings per year is a substantial amount of energy. It is the equivalent of 1 million barrels of oil per day, or about 20 percent of all U.S. oil imports in 1981. It is also equivalent to about 36 electric generating plants of 1,000 **MW** each, at average utilization rates. There are two ways of estimating the value of 2 Quads of energy savings in 1981 dollars; they would be worth \$14 billion at the 1981 average price for home heating oil of

about \$1 per gallon, or \$20 billion to \$30 billion at the current estimated price of synthetic oil from coal in 1981 dollars. (See the forthcoming OTA report on synfuels for further discussion. )

The value of savings from an equivalent subsidy to district heating is much less. If district heating primarily serves to shift demand from premium fuels, such as oil and gas to coal, the savings comes from the price difference between the two kinds of fuel. At \$4 per million Btus, (about the current price differential between oil and coal for utilities), substituting 0.3 Quad of heat from coal for heat from oil would be worth \$1.2 billion.

It also may be possible, although OTA has not analyzed this option, to achieve the same impact on energy retrofit not by subsidizing retrofit but by reducing or eliminating the tax deduction of energy costs as a business expense, since this tax deduction has the effect of subsidizing the inefficient use of fuel.

**Energy Conversion Factors**

| To convert   | Into   | Multiply by approximately | Exactly   |
|--|--|---------------------------|---|
| <b>Energy units used in national energy projections</b>                  |  |                           |   |
| 1. Quads/year.....   | Millions of barrels of oil per day                       | 0.5                       | 0.4760  |
| 2. Quads.....  | Trillion cubic feet of natural gas                       | 1.0                       | 0.9872  |
| 3. Quads.....  | Million tons of coal                                     | 44.0                      | Depends on type of coal   |
| 4. Quads.....  | Billions of kWh  | <b>300.0</b>              | <b>294.0000</b>   |
| 5. Quads/year of primary fuel <sup>a</sup> .....                         | Number of 1,000-MW powerplants                           | 18.0                      | Depends on specific assumptions   |
| <b>Energy units used in building energy analysis</b>                     |  |                           |   |
| 1. Million Btu/year.....   | Thousand kWh/year  | <b>300.0</b>              | <b>294.0000</b>   |
| 2. Million Btu/year.....   | Gallons of fuel oil                                      | 7.0                       | 7.1400  |
| 3. Million Btu/year.....   | Thousand cubic feet of natural gas                       | 1.0                       | 0.9870  |
| 4. Million Btu/year.....   | Therms of natural gas                                    | 10.0                      | 10.0000   |
| <b>Energy units used in district heating analysis</b>                    |  |                           |   |
| 1. Trillion Btu of annual thermal output.....                            | Million kWh of annual output (thermal kWh)               | 300.0                     |   |
| 2. Megawatts (thousand kilowatts) of thermal capacity <sup>b</sup> ..... | Million Btu of annual thermal output                     | 8,800.0                   | Depends on specific assumptions about capacity, etc.                                      |
| 3. Billion Btu of annual output <sup>c</sup> .....                       | Kilowatts of peak thermal capacity                       | 114.0                     |   |
| 4. Million Btu/hour of peak thermal output.....                          | Kilowatts of peak thermal capacity                       | 300.0                     |   |
| <b>Energy units used in powerplant analysis</b>                          |  |                           |   |
| 1. 1,000 megawatts of electric generating capacity <sup>d</sup> .....    | Trillion Btu of annual end-use output of electricity     | 17.5                      |   |
| 2. 1,000 megawatts of electric generating capacity <sup>e</sup> .....    | Million Btu of primary fuel used to generate electricity | 58.0                      | Depends on specific assumptions about capacity utilization and fuel conversion efficiency |
| 3. Billion Btu of annual end-use electricity.....                        | Kilowatts of electric generating capacity                | 57.0                      |   |
| 4. Billion Btu of annual primary fuel used to generate electricity.....  | Kilowatts of electric generating capacity                | 18.0                      |   |

NOTES: Assumptions used in conversions between annual energy output and peak capacity for district heating and electric powerplants

- <sup>a</sup>If one 1,000-MW plant requires 56,555 billion Btu/year primary fuel consumption (see explanation e below) then 1 Quad/O 0565 Quad Per plant<sup>17.71,000-MW plants per Quad</sup>
- <sup>b</sup>1 MW x 8,766 hours x 0.3 capacity factor = 2,632,000 kWh/300 kWh per million Btu = 8,773 million Btu
- <sup>c</sup>1,000 million Btu (1 billion Btu) x 300 kWh per million Btu = 300,000 kWh/ (8,766 hours per year x 0.3 capacity factor) = 114 kW generating capacity
- <sup>d</sup>1,000 MW x 8,766 hours x 0.6 capacity factor = 5,260,000 kWh per year/300 kWh per million Btu = 17,532 billion Btu/year end-use electricity per year from one 1,000-MW plant
- <sup>e</sup>To produce 17,532 billion Btu/year end-use electricity from a 1,000-MW powerplant - by 0.31 (efficiency of conversion from fuels to electricity) = 56,555 billion Btu/year primary fuel consumption for one 1,000-MW powerplant
- <sup>f</sup>One billion Btu of annual end-use electricity x 300 = 300,000 kWh annual output - (8,766 hours per year x 0.6 capacity factor) = 57 kW of electric generating capacity
- <sup>g</sup>One billion Btu of primary fuel used to generate electricity x 0.31 efficiency of conversion from fuels to electricity = 31 (1 million Btu of end-use electricity x 300 kWh per million Btu = 93,000 kWh end-use output - (8,766 hours per year x 0.6 capacity factor) = 177 kW of capacity

Chapter 2

**Importance of City Buildings in  
National Energy Use: Will Energy  
Efficiency Make a Difference?**

# Contents

|   | <i>Page</i> |
|---|-------------|
| <b>Trends In Building Energy Use</b> . . . . .                                      | 27          |
| <b>Central City Building Stock</b> . . . . .  | 31          |
| Forecast Energy Prices . . . . .  | 31          |
| <b>Projections of Building Energy Use.</b> . . . . .                                | 32          |
| Projections of the Impact of Energy Conservation on Building Energy Use. . . . .    | 32          |
| <b>Contribution of the Buildings in This Study to Future Building Energy Use...</b> | 33          |
| <b>Energy Savings Potential and Likelihood of Retrofit</b> . . . . .                | <b>34</b>   |
| <b>Chapter 2 Appendix—Assumptions</b>   |             |
| Used in Calculating Projected Energy Savings From Retrofit of Buildings . . . . .   | 36          |

## LIST OF TABLES

| <i>Tab/e No.</i>   | <i>Page</i> |
|--|-------------|
| <b>7.</b> Primary Energy Consumption in Different Types of Buildings . . . . .         | <b>27</b>   |
| <b>8.</b> EIA's Projection of Primary Energy Use in Buildings in the Year 2000.. . . . | 32          |

|  | <i>Page</i> |
|--|-------------|
| 9. Two Projections of Reduced Building Energy Use in the Year 2000 . . . . .   | 33          |
| 10. Likely Primary Energy Savings Compared to the Technically Possible Savings for Building Types Covered in This Report . . . . . | 35          |

## LIST OF FIGURES

| <i>Figure No.</i>   | <i>Page</i> |
|---|-------------|
| 2. Trends in Primary Energy Use by <b>Sector</b> , 1960-80 . . . . .                                      | 28          |
| 3. History and Projections of End-Use Energy by Fuel Type: Residential and Commercial Buildings . . . . . | 29          |
| 4. Trends in the Price of Delivered Electricity, 1960-80 . . . . .  | 29          |
| 5. Trends in the Price of Delivered Natural Gas, 1960-80 . . . . .  | 29          |
| 6. Trends in the Price of Delivered Home Heating Oil, 1960-80 . . . . .                                   | 30          |
| 7. Trends in Real Energy Prices, 1960-80 . . . . .  | 30          |
| 8. Primary Energy Use by Fuel and End-Use for Residential Buildings, 1980 . . . . .                       | 30          |
| 9. Primary Energy Use by Fuel and End-Use for Commercial Buildings, 1980 . . . . .                        | 30          |



## Importance of City Buildings in National Energy Use: Will Energy Efficiency Make A Difference?

Residential and commercial buildings together account for about one-third of U.S. energy consumption. The buildings that are the primary subject of this report—multifamily buildings, office buildings, retail buildings, hotels, educational buildings, public buildings, and single-family homes inside central cities—together used about half of all U.S. building energy in 1980. Most of the rest of the building energy in the United States is used by single-family homes outside central cities. A previous OTA report, *Residential Energy Conservation*, described at length the prospects for improved efficiency of single-family homes. This report also discusses single-family houses but only in the context of those building and owner types characteristic of central cities. Table 7 shows what share of U.S. building energy use is used by different building types.

**Table 7.—Primary Energy Consumption in Different Types of Buildings (1975)**

| Building type                       | Quads | Percent of building energy |
|-------------------------------------|-------|----------------------------|
| Single-family residential . . . . . | 15.3  | 57.5%                      |
| Multifamily low density . . . . .   | 0.7   | 2.6                        |
| Multifamily high density . . . . .  | 1.6   | 6.0                        |
| Mobile homes . . . . .              | 0.3   | 1.1                        |
| Office . . . . .                    | 4.4   | 5.2                        |
| Retail/wholesale . . . . .          | 2.2   | 8.3                        |
| Garage . . . . .                    | 0.1   | 0.3                        |
| Warehouse . . . . .                 | 0.3   | 1.1                        |
| Educational . . . . .               | 1.7   | 8.4                        |
| Public . . . . .                    | 0.4   | 1.5                        |
| Hospital . . . . .                  | 0.7   | 2.6                        |
| Religious . . . . .                 | 0.3   | 1.1                        |
| Hotel/motel . . . . .               | 0.5   | 1.6                        |
| Miscellaneous . . . . .             | 1.1   | 4.1                        |
| Total . . . . .                     | 26.6  | 100                        |

NOTE: Percentages may not add to 100% due to rounding

SOURCE: Alton J. Penz, "Building Energy Efficiency: The Motivation for Change," Institute for Building Sciences Research Report No. 16, Carnegie Mellon University, April 1981, table 2, p. 10. These numbers were estimated from estimates of numbers of buildings, building square footage and energy use per square foot, for different building categories (Details available from Mr. Penz.) They are generally consistent with but not precisely the same as estimates of commercial energy use in Jerry Jackson, *The Commercial Demand for Energy: A Disaggregated Approach*, Oak Ridge, ORNL/CON-15, p. 11, and estimates of residential energy use in Eric Hirst, et al. *The ORNL Engineering-Economic Model of Residential Energy Use*, Oak Ridge, ORNL/CON-24, appendix.

### TRENDS IN BUILDING ENERGY USE

Primary energy use in buildings essentially remained constant from 1976 to 1980 despite continued expansion of total square feet. The long-term trends are shown in figure 2. Since 1965, building energy use has increased at about the same rate as energy for either transportation or industry. The most important source of increase in energy use in both commercial and residential buildings has come from their increasing dependence on electricity. As can be seen in figure 3, the share of final demand for electricity increased from about 9 to 20 percent in the residential sector and from about 13 to about 21 percent in the commercial sector. In terms of primary energy (see footnote 1), electricity use by all buildings (1965-80) in-

creased from 36 to 49 percent in commercial buildings and from 31 to 48 percent in residential buildings.

These trends—overall slow growth in the energy use of buildings but a rapid increase in the share of electricity—can be understood in light of the trends in the prices of those fuels used by buildings. While the prices of all fuels increased rapidly in current dollars over the decade from 1970 to 1980 (see figs. 4, 5, and 6) the real price of electricity (in 1972 dollars) increased quite slowly, by only 11 percent over the decade, while the real price of natural gas (in 1972 dollars) increased by 66 percent and the real price of fuel oil (in 1972 dollars) increased by 153 percent. The contrast between the slow increases in real electricity prices and the more rapid increases in real natural gas and fuel oil prices can be seen clearly in figure 7. To be sure the price of electricity varies more from

<sup>1</sup>This is based on tables of energy end-use by fuel and sector in the Energy Information Administration, *1980 Annual Report to Congress*, April 1981. Electricity end-use was multiplied by 3.3705 to get primary energy. This assumes 3,412 Btu/kWh electricity end-use and 11,500 Btu/kWh primary energy.

**Figure 2.—Trends in Primary Energy Use by Sector, 1960-80**

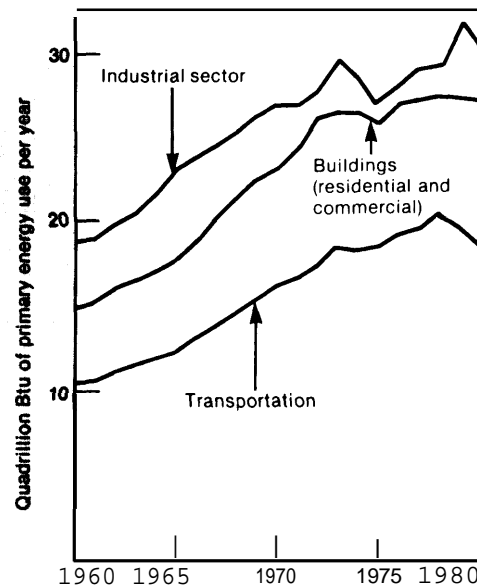

NOTE Primary energy includes energy used to generate electricity. Energy consumption by electric utilities is allocated to the major end-use sectors in proportion to electricity sales by privately owned Class A and B electric utilities. These electric utilities accounted for 78 percent of total electricity sales in 1979.

SOURCE Energy Information Administration, *1980 Annual Report to Congress*, April 1981

region to region than the price of natural gas or fuel oil. A few utilities such as Long Island Lighting (1 5.5 percent growth per year from 1973 to 1979) and Arizona Public Service (1 3.9 percent per year) experienced rapid growth in prices.<sup>2</sup> The price increases by these utilities, however, were offset by slow growth in prices of electricity by other utilities such as Cincinnati Gas & Electric (6.9 percent per year) and Puget Sound Gas & Electric (7.0 percent per year). Electricity

<sup>2</sup>Increases in Residential Electricity Rates. Source: Electrical World, *Directory of Electric Utilities*, 1974-75, 83d ed., 1974; and 1980-81, 89th ed., 1980. (See table 1 in ch. 9 of this report.)

prices in the latter two utilities actually increased slightly more slowly than the general increase in prices over the same period. J

For both residential and commercial buildings, the biggest share of energy goes for space heat (see figs. 8 and 9). Space cooling and lighting are the next most important uses of energy for commercial buildings while hot water and cooling are for residential buildings.

<sup>1</sup>Electrical World, op. cit.; G N P deflator increased at 7.4 percent per year from 1973-79 (vol. 2: EIA, *1980 Annual Report to Congress*, April 1981).

**Figure 3.—History and Projections of End-Use Energy by Fuel Type: Residential and Commercial Buildings**

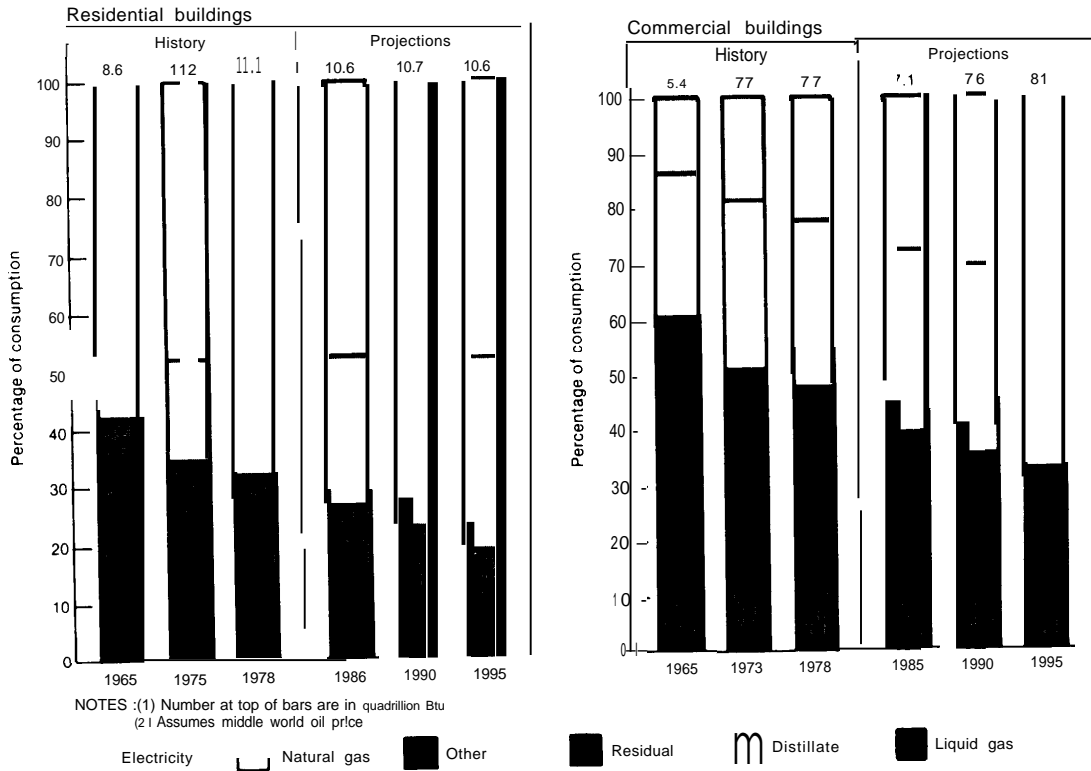

SOURCE: Energy Information Administration, *1980 Annual Report to Congress*, April 1981, pp. 60-61

**Figure 4.—Trends in the Price of Delivered Electricity, 1960-80**

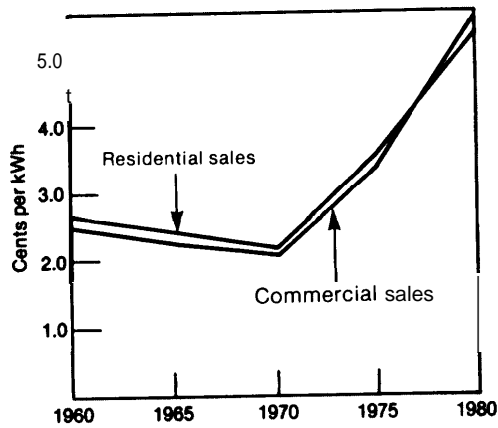

SOURCE: *1980 Annual Report to Congress, Volume 2*, DOE/EIA-0173 (80)/2, Energy Information Administration, U.S. Department of Energy, Washington, D.C., April 1981.

**Figure 5.—Trends in the Price of Delivered Natural Gas, 1960-80**

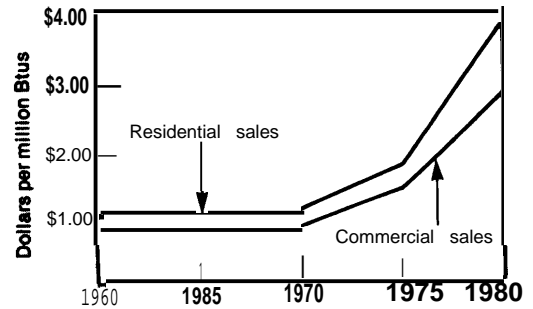

SOURCE: *1980 Annual Report to Congress, Volume 2*, DOE/EIA-0173 (80)/2, Energy Information Administration, U.S. Department of Energy, Washington, D.C., April 1981.

Figure 6.—Trends in the Price of Delivered Home Heating Oil, 1960-80

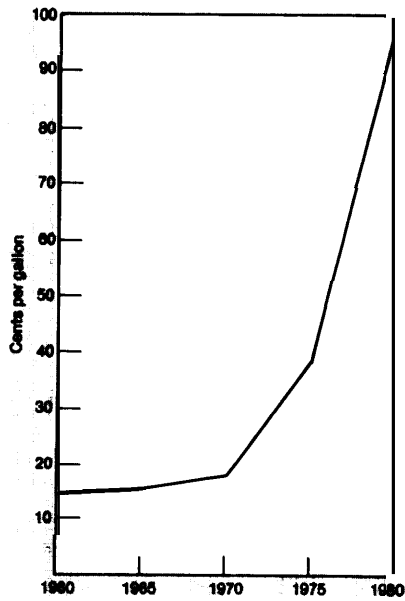

SOURCE 1980 Annual Report to Congress, Volume 2, DOE/EIA-0173 (80)/2, Energy Information Administration, U.S. Department of Energy, Washington, D.C., April 1981.

Figure 7.—Trends in Real Energy Prices (1972 dollars), 1960-80

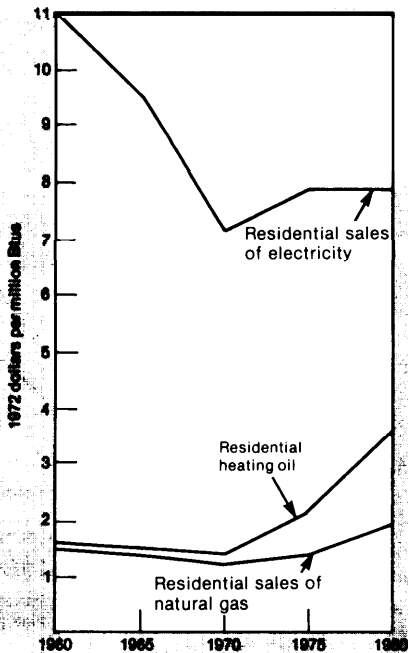

SOURCE: 1980 Annual Report to Congress, Volume 2, DOE/EIA-0173 (80)/2, Energy Information Administration, Washington, D.C., April 1981.

Figure 8.—Primary Energy Use by Fuel and End-Use for Residential Buildings, 1980

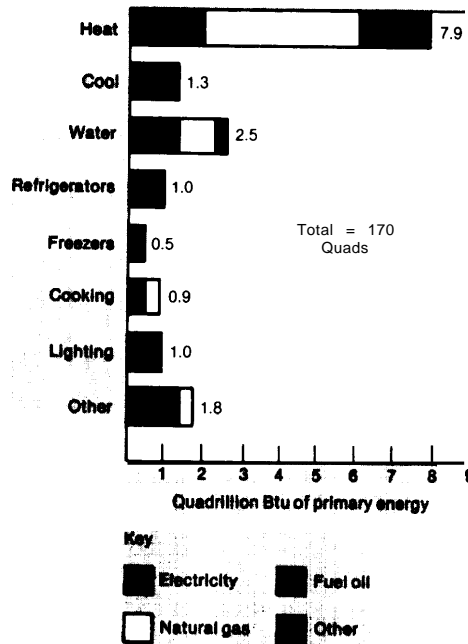

SOURCES: 1980 Annual Report to Congress, Volume 2, DOE/EIA-0173 (80)/2, Energy Information Administration, U.S. Department of Energy, Washington, D.C., April 1981; Office of Technology Assessment

Figure 9.—Primary Energy Use by Fuel and End-Use for Commercial Buildings, 1980

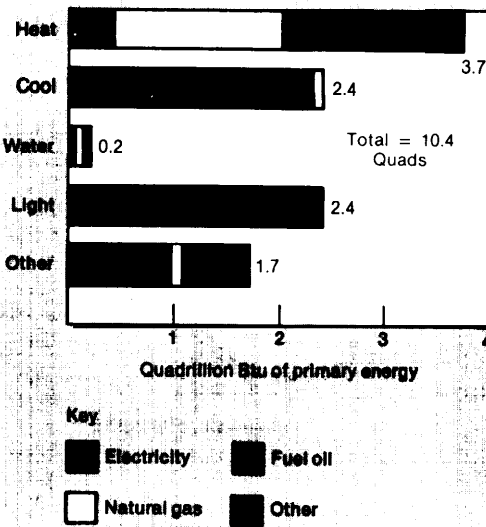

SOURCES: 1980 Annual Report to Congress, Volume 2, DOE/EIA-0173 (80)/2, Energy Information Administration, U.S. Department of Energy, Washington, D.C., April 1981; The Commercial Demand for Energy: A Disaggregated Approach, ORNL/CON-15, Oak Ridge National Lab, April 1978; Office of Technology Assessment.

## CENTRAL CITY BUILDING STOCK

More than half of all the denser forms of housing are located in central cities: 48 percent of all attached housing, 50 percent of all multifamily housing buildings with two to four units, and 56 percent of all multifamily housing in buildings of five units or more.<sup>4</sup> Only 21 percent of all single-family houses are located in central cities, but single-family houses, nonetheless, are a large fraction (43 percent) of all the housing units in central cities.

OTA was not able to assemble national data on the urban, suburban, or rural location of the 4 million commercial buildings. The first survey of the commercial building stock was published in March 1981 by the Energy Information Ad-

<sup>4</sup>*Annual Housing Survey, 1978: Part A General Housing Characteristics*, U.S. Department of Commerce, Bureau of the Census, and U.S. Department of Housing and Urban Development.

ministration (EIA) of the Department of Energy, but it did not include data on the location of buildings (central city, metropolitan area outside central city, or rural). Rough estimates of commercial location could in theory be constructed from fire insurance maps for individual cities but this is time-consuming and difficult to make representative of the whole building population. Estimates can also be constructed from employment data. This method is also subject to considerable inaccuracy.<sup>5</sup>

<sup>5</sup>*Nonresidential Buildings Energy Consumption Survey: Building Characteristics*, March 1981, DOE/EIA-0246, Energy Information Administration. Estimating the location of the commercial building stock from employment data reported in Commerce Department reports on *County Business Patterns* suffers from two problems: employment data by county is not complete and there is no accurate information on square footage per employee. Furthermore, there is no way to estimate the size distribution of commercial buildings from employment data.

## FORECAST ENERGY PRICES

There is considerable uncertainty about future energy prices for different fuels. While most published forecasts agree that the price of oil will continue to increase rapidly (and they may also be equally wrong), there is no consensus about the likely impact of price increases in either electricity or natural gas. On the one hand, forecasts of relative stability in electricity prices (at least by the late 1980's) in many parts of the country are based on assumptions of the continued regulation of electricity prices (which averages in high-priced electricity with low priced). Other assumptions are a gradual shift in electricity generation away from high-priced oil and natural gas and a slowdown in the addition of new generating plant with its expensive debt service. On the other hand, continued dependence on oil and gas and further rapid additions of new generating plant could lead to continued substantial increases in the price of electricity.

As in the past the price of electricity will vary sharply from utility to utility. Some utilities will experience price increases considerably faster than inflation; others will have electricity prices falling relative to the general price level.

There is equal uncertainty about the price path of natural gas that is still regulated but which is scheduled to be gradually increased in price until 1985. Full deregulation would increase the pace of price increases but it is not clear where the price of natural gas would settle relative to oil and electricity prices. Since natural gas competes with efficient use of electricity in buildings and industry there is some speculation that the price of gas may eventually stabilize if the price of electricity stabilizes. On the other hand, it may increase to full parity with oil prices.

## PROJECTIONS OF BUILDING ENERGY USE

In the most recent forecast of energy use prepared by EIA, and shown in table 8, primary energy use by buildings (including the fuel used to generate electricity), is projected to increase by about 35 percent between now and the year 2000. Commercial floorspace is projected to increase by 2.4 percent per year and residential dwelling units are projected to increase by 2 million units per year, or about 2.5 percent per year. For both residential and commercial buildings, increased primary energy use is largely due to a projected increase in the share of end-use electricity (see fig. 3).

The accuracy of such projections is limited by the fact that there are far better data available

**Table 8.—EIA’s Projection of Primary Energy Use in Buildings in the Year 2000**

|                       | Primary energy use<br>(quadrillion Btu) |             |                |
|-----------------------|---|-------------|----------------|
|                       | 1980                                    | 2000        | Percent change |
| Residential. . . . .  | 17.0                                    | 20.9        | + 230/o        |
| Commercial . . . . .  | 10.4                                    | 16.0        | + 54           |
| <b>Total combined</b> | <b>27,4</b>                             | <b>36.9</b> | <b>+35</b>     |

SOURCE 1980 *Annual Report to Congress*, Energy Information Administration, April 1981, p. 142, Mid. Level 011 Price Projection

on which to base a projection of residential energy use than for a projection of commercial building energy use. The U.S. Census collects regular data on numbers of dwelling units by type and location and on new construction and demolition of dwelling units. Until this year (when EIA completed a survey of commercial buildings), there were no such comprehensive data on the U.S. commercial building stock. Based on data obtained in the survey, EIA estimated the current stock of commercial and industrial buildings at 52 billion ft<sup>2</sup>, a much higher figure than the 32 billion ft<sup>2</sup> of at least one previous estimate.<sup>6</sup> There are very incomplete data on annual demolitions or annual new construction of commercial buildings, so there are as yet no data on which to base an estimate of how fast the commercial building stock is likely to increase.

<sup>6</sup>*Nonresidential Buildings Energy Consumption Survey: Fuel Characteristics and Conservation Practices*, fig. 1, p. 4. Energy Information Administration, June 1981. One prior estimate was made by Oak Ridge as reported in *A User's Guide to the ORNL Commercial Energy Use Model*, R. W. Barnes, C. J. Emerson, Kenton R. Corum, ORNL/CON-44, Oak Ridge National Laboratory, May 1980, p. 40.

## PROJECTIONS OF THE IMPACT OF ENERGY CONSERVATION ON BUILDING ENERGY USE

There are two different approaches to estimating the impact of energy conservation on building energy use and both of these are illustrated in table 9. Both assume that strenuous efforts are made to induce energy conservation beyond what is likely to be induced by an increase in energy prices. The impact of energy prices alone is incorporated in a base case or trend energy projection.

One approach is to assume that high conservation policies increase the relative energy efficiencies of different appliances and heating and cooling systems but that the increased efficiencies are offset by increased use of these more efficient appliances and systems. As calculated by

EIA, this results in a modest reduction from trend energy use of 6 percent in residential buildings and 10 percent in commercial buildings by 1990. Applying these same percentages to 2000, as has been done in table 9, gives a modest reduction of 3 Quads from trend energy use. Even if the percentage impact in 2000 were double what was estimated for 1990 by EIA the reduction would only be about 6 Quads.

Another approach, also illustrated in table 9, is to calculate the technical feasibility of different improvements in energy efficiency and assume that all of them which fall within some defined limit of cost effectiveness will be carried out. This approach was used by the Solar Energy

**Table 9.—Two Projections of Reduced Building Energy Use in the Year 2000**

| Definition of projection  | Projected building energy use in the year 2000<br>(quadrillion Btu of primary energy) |      |
|---|---|------|
|   | Energy Information  |      |
|   | Administration  | SERI |
| Trend or base case . . . . .  | 36.9  | 35.3 |
| Assuming all technically feasible<br>improvements in energy efficiency. . . . | —   | 18.3 |
| Projection assuming "high conservation"<br>Federal policies . . . . .         | 33.6a   | —    |
| Reduction in energy use . . . . .   | 3.3   | 17.0 |

<sup>a</sup>Applies percentage reductions in residential and commercial use in "high conservation use" in 1990 to the projection of trend energy use in 2000

SOURCE 1980 *Annual Report* to Congress, Energy Information Agency, p 65 and *A New Prosperity Building a Sustainable Energy Future* The SE RI/SOLAR Conservation Study (Andover, Mass Brick House Publishing, 1981), p 13

Research Institute (SERI) for its report *Building a Sustainable Energy future*. SERI calculated the cost of retrofits to several prototypical buildings assuming the retrofits would be paid for in annual payments on a loan of 3-percent real interest rates over the lifetime of the measure (generally 20 years). Any retrofit costing less per Btu saved (on this basis) than the current (1980) cost of fuel oil or electricity would be considered cost effective. The technical potential for reduc-

tions in energy use calculated in this way is much greater than the reductions projected by EIA, 17 Quads instead of 3. The difference between these two projections is a measure of the range of controversy about how much of the technically feasible reductions in building energy use are likely to come about within the framework of the decisions made by those responsible for buildings.

## THE CONTRIBUTION OF THE BUILDINGS IN THIS STUDY TO FUTURE BUILDING ENERGY USE

This study looks more closely at some residential and commercial building types to examine how much cost-effective retrofit might actually occur given the motivation of different owners to invest in retrofit. The analysis that follows draws on the detailed analysis in the rest of the report but relies on some simplifying assumptions consistent with that analysis. It also ignores some subtleties important for designing retrofit strategies for particular cities but not important when analyzing national energy use two decades from now. The overall analysis presented here is designed for simplicity and clarity. Readers should be aware that the main objective of the whole report was not to perform a national energy forecast but to clarify the complexity of the building sector that is one of the most inherently local of all economic sectors in the way in which decisions are made about growth and investment.

From table 7 energy use for the primary building types covered in this report are obtained. They are as follows:

|                            |           |
|----------------------------|-----------|
| Multifamily . . . . .      | 2.3 Quads |
| Off ice buildings. . . . . | 1.4 Quads |
| Retail/wholesale . . . . . | 2.2 Quads |
| Hotel/motel . . . . .      | 0.5 Quad  |

In addition to these building types, owner motivation and public policies are analyzed for three other building types:

|   |           |
|---|-----------|
| E d u c a t i o n a l   b u i l d i n g s                   | 1.7 Quads |
| Public buildings. . . . .                                   | .04 Quad  |
| Single-family homes owned by<br>low-income people'. . . . . | 1.6 Quads |

<sup>7</sup>See appendix to this chapter for assumptions used in calculating energy use by low-income people.

The technical potential and owner motivation for all these categories of building types is assessed regardless of where they are located, on the grounds that such building types make up a large fraction of buildings in central cities but that city/suburban boundaries do not make an important difference in the retrofit potential of such buildings.

The study, however, devotes some brief attention to another group of buildings only to the extent they are located in central cities. These are single-family houses owned by families of all income classes, but located in central cities. **AI-**

though the technical potential for retrofit and owner motivation for retrofit of such buildings was thoroughly analyzed in OTA's previous report on Residential Energy Conservation, this new report sheds some additional light on public and private programs to stimulate retrofit in these buildings. Single-family houses in cities use a large fraction of city building energy use:

Single-family houses in cities. . . . ., 3.5 Quads

All of these building types taken together used half the building energy use in 1975.

## ENERGY SAVINGS POTENTIAL AND LIKELIHOOD OF RETROFIT

The analysis of the likely energy savings compared to the possible energy savings for the building types covered in the report uses a set of simple assumptions consistent with the results of the detailed analysis described in the rest of the chapters of the report.

The detailed assumptions used in the analysis are described in the appendix to this chapter and include assumptions about:

- The rate of demolition of the current building stock.
- The rate of addition of new energy inefficient buildings (since these will require retrofit to become energy efficient).
- The technical potential for retrofits of different types of buildings.
- The likelihood that different types of owners will actually retrofit their buildings.
- The share of commercial buildings that are owner occupied.
- The share of residential dwelling units that are occupied by low-income people.

Using these assumptions, OTA calculated for each building and owner type:

- Projected trend energy use in 2000 (same as 1975 because of cumulative effect of changes due to demolition or additions of energy inefficient buildings).
- Savings if all technically feasible, cost-effective measures were installed.

- Likely savings (either fast payback retrofits only or maintenance and use savings only).
- The gap between technically possible savings and likely savings.
- What share of the gap is represented by fast payback savings that are not likely to be achieved.

Since the projection is meant to illustrate the implications of the findings in the study if they were carried forward, the calculations assume current energy prices in estimating the technically feasible retrofits (as did the SERI projection described above) and current costs and accessibility of capital in estimating the likely response of building owners. No attempt to forecast changes in real energy prices or changes in the cost of capital was made. If real energy prices on average were to increase significantly the amount of technically feasible retrofit would increase slightly, and if the cost of capital were to fall significantly, the motivation of building owners to retrofit should increase. Readers of this report may take these two possibilities into account in judging the implications of OTA'S projections.

Potential and likely savings are shown for each building type in table 10. The results for all buildings needing retrofit between now and 2000 and covered in this report can be summarized as follows:

- For the building types covered in this report, the total trend energy use in 2000 of



**Table 10.—The Likely Primary Energy Savings Compared to the Technically Possible Savings for Building Types Covered in This Report**

| Building types   | Trend energy use <sup>a</sup> | Technical savings potential | Year 2000      |  |   |
|--|-------------------------------|-----------------------------|----------------|--|---|
|  |                               |                             | Likely savings | Gap: technical potential saving not realized | Gap: fast-payback savings not realized <sup>b</sup> |
| <b>Residential</b>   |                               |                             |                |  |   |
| <b>(quads of Btus)</b>   |                               |                             |                |  |   |
| <b>Single-family buildings</b>                                       |                               |                             |                |  |   |
| • Low income   | 1.6                           | 0.8                         | 0.2            | 0.6  | (0.2)   |
| • Moderate and upper income in cities                                | 3.5                           | 1.8                         | 0.9            | 0.9  | 0   |
| • Moderate and upper income outside cities (not dealt within report) | (10.2)                        | (5.1)                       | (2.5)          | (2.5)  | 0   |
| • Mobile Homes   | (0.3)                         | unknown                     | unknown        | unknown                                      | unknown   |
| <b>Multifamily buildings</b>   |                               |                             |                |  |   |
| • Low-income   | 0.6                           | 0.2                         | 0.1            | 0.1  | (0.1)   |
| • Moderate and upper income master-metered                           | 0.9                           | 0.4                         | 0.1            | 0.3  | (0.1)   |
| • Moderate and upper income tenant-metered                           | 0.8                           | 0.4                         | 0.1            | 0.3  | (0.1)   |
| Total residential energy dealt with in this report                   | 7.4                           | 3.6                         | 1.4            | 2.2  | (0.5)   |
| Not dealt with in this report  | (10.5)                        |                             |                |  |   |
| Total residential primary energy                                     | 17.9                          |                             |                |  |   |
| <b>Commercial buildings</b>  |                               |                             |                |  |   |
| <b>Office buildings</b>  |                               |                             |                |  |   |
| • Owner-occupied   | 0.7                           | 0.4                         | 0.2            | 0.2  | 0   |
| • Investor-owned   | 0.7                           | 0.4                         | 0.1            | 0.3  | (0.1)   |
| <b>Retail buildings</b>  |                               |                             |                |  |   |
| • Owner-occupied   | 1.1                           | 0.6                         | 0.3            | 0.3  | 0   |
| • Investor-owned   | 1.1                           | 0.6                         | 0.1            | 0.5  | (0.2)   |
| <b>Hotel/motel</b>   |                               |                             |                |  |   |
| • Owner-occupied   | 0.3                           | 0.2                         | 0.1            | 0.1  | 0   |
| • Investor-owned   | 0.3                           | 0.2                         | 0              | 0.2  | (0.1)   |
| <b>Educational buildings</b>   | 1.7                           | 0.9                         | 0.4            | 0.5  | 0   |
| <b>Public buildings</b>  | 0.4                           | 0.2                         | 0.1            | 0.1  | 0   |
| Commercial energy dealt with in this report                          | 6.3                           | 3.5                         | 1.3            | 2.2  | (0.4)   |
| Not covered in this report:  |                               |                             |                |  |   |
| • Hospitals  | (0.7)                         |                             |                |  |   |
| • Warehouses   | (0.3)                         |                             |                |  |   |
| • Religion   | (0.3)                         |                             |                |  |   |
| • Miscellaneous  | (1.1)                         |                             |                |  |   |
| • Total  | (2.4)                         |                             |                |  |   |
| Total commercial primary energy                                      | 8.7                           |                             |                |  |   |
| <b>Total energy covered in this report</b>                           | <b>13.7</b>                   | <b>7.1</b>                  | <b>2.7</b>     | <b>4.4</b>                                   | <b>(0.9)</b>  |
| Total building energy  | 26.6                          |                             |                |  |   |

<sup>a</sup>Assumes 2000 energy use by inefficient building 1975 use (see text)

<sup>b</sup>Fast-payback savings not realized are included in figures on total savings not realized in column at left

SOURCE Office of Technology Assessment

- buildings in existence in 1980 plus the fraction of buildings built between now and 2000 that are energy inefficient (about 33 percent) is projected to be 13.7 Quads (out of a total building energy use for existing buildings and new energy-inefficient buildings of **26,6** Quads).
- Of this energy use, technically feasible and cost-effective (see p. 4 for definition) retrofits could produce 7.1 Quads of savings.

- Only 2.7 Quads of savings of this amount are actually likely to be saved because of stringent criteria applied to energy retrofits placed by building owners of different kinds and described in chapter 4 of this report.
- Of the estimated 4.4-Quad gap between the technical potential for savings from retrofit and likely savings from retrofit, about 0.9 Quad are very cost-effective retrofits

(fast payback retrofits) that will not be installed because some owners totally lack financial means (low-income owners) or motivation (owners of tenant-metered multifamily buildings) or both. The rest of the gap, 3.5 Quads, represents the retrofits that

cost more compared to the savings they bring about but would still be considered cost-effective investments by an investor with a long perspective. Of these about 2.5 Quads are from retrofits of moderate payback.

## CHAPTER 2 APPENDIX—ASSUMPTIONS USED IN CALCULATING PROJECTED ENERGY SAVINGS FROM RETROFIT OF BUILDINGS

The assumptions used in constructing table 10 were as follows:

**Trend Energy Use in the Year 2000 of Building Types Covered in This Report That Are Also Candidates for Retrofit.—For simplicity** this is assumed to be the same as the breakdown shown in table 7 for 1975. This result comes about because a set of far more complicated assumptions have the overall effect of canceling each other out. The more detailed assumptions are as follows:

- **1980** building energy use is **3** percent higher than 1975 energy use.
- Residential buildings in existence in 1980 will be demolished at 1 percent per year until 2000 leaving 82 percent of the 1980 buildings standing. Commercial buildings will be demolished at 1.25 percent per year leaving 74 percent of the 1974 buildings still standing.
- New residential buildings will be constructed between 1980 and 2000 equivalent to 50 percent of the 1980 building stock. One third of these, or about 17 percent of the 1980 building stock will be energy inefficient and will need retrofit.
- New commercial buildings will be constructed between 1980 and 2000 equivalent to 60 percent of the 1980 building stock. One third of these (or 20 percent of the 1980 building stock) will be energy inefficient and will need retrofit.
- Compared to the 1975 stock the result of these assumptions is that trend building energy use for those buildings needing retrofit in **2000** will be 102 percent of 1975 energy use for residential buildings and 97 percent for commercial buildings. This is too close to 1975 energy use to make any difference in OTA's crude calculations of savings potential and so the 1975 energy was used as a starting point.

**Low-Income Share of Single-Family and Multifamily Housing.—OTA** assumed that 10 percent of all single-family energy use is low income and 25 percent of all multifamily energy use. This is based

on the further assumption that 13 percent of single-family owners are low income (125 percent of poverty) and they use 80 percent of the energy used by moderate and upper income. For multifamily renters, 30 percent are assumed to be low income, also using 80 percent of the energy used by moderate and upper income people.

**Master and Tenant Metering of Multifamily Buildings.—OTA** assumed that half of all multifamily buildings are master metered and that this proportion will not change between now and 2000.

**Technical Potential of Retrofit of Commercial Buildings.—Based** on the analyses of retrofit potential described in chapter 5, it is assumed that if all cost-effective measures were installed in commercial buildings, the average energy savings would be 50 percent of trend energy use.

**Technical Potential for Retrofit of Residential Buildings.— From the analysis** in chapter 5 *multifamily* buildings, on average, have less retrofit potential. OTA assumed a potential savings of 40 percent of trend energy use. For *single-family buildings* OTA assumed a technical retrofit potential of 50-percent savings.

**Owner Occupancy of Office, Retail, and Hotel Buildings.—OTA** assumed that **50 percent of these buildings** are **owner occupied**. This is consistent with the data in the March 1981 survey of nonresidential buildings (see footnote 5 for reference). EIA data shows that the proportion of owner occupancy averages 48 percent and does not vary greatly by type of commercial building or size of building.

**Savings Achieved by Fast-Payback Retrofits.—**Based roughly on the technical analysis described in chapter 5, OTA assumed that 20-percent savings can be achieved by fast payback retrofits in multifamily buildings and that 30-percent savings can be achieved by fast payback retrofits in commercial buildings and single-family buildings.

**Savings Achievable by Changes in Maintenance and Behavioral Practices.—OTA** assumed that 10-percent savings is achievable in all building types

without capital investment but with changes in use and maintenance practices.

**Willingness of Owner Types To Do Retrofits.—**

Based on the analysis of building owner motivation in chapter 6, OTA made the following assumptions about average owner willingness to retrofit their build buildings:

- Willing to invest **in** a full set of technically feasible retrofits. None as a group although small categories within some groups.
- Willing to invest in *fast* payback retrofits *only*.
  - Owner-occupants of office buildings, retail buildings and hotels. The willingness of the better financed owners of these buildings to
- do more is offset by the reluctance of the poorly financed owner-occupants to do *any* retrofits.
- Owners of educational and public buildings.
- Moderate and upper income owners of single family buildings in cities.
- Master-metered multifamily buildings.
- Unwilling to retrofit *but* achieving *savings due to* changes in *use or behavior*.
  - investor-owners of office buildings, retail buildings, and hotels.
  - Owners of tenant-metered multifamily buildings.
  - Low-income owners of single-family homes.

## Chapter 3

# Technical Potential for Improving the Energy Efficiency of Buildings in Cities

## Contents

|   | Page |   | Page |
|---|------|---|------|
| Introduction . . . . .  | 41   | Site-Specific Nature of Building Retrofit. . . . .              | 80   |
| A Few Characteristics of Buildings<br>Influence Their Retrofit Potential. . . . .               | 43   | Unpredictability of Savings From<br>Building Retrofits. . . . . | 84   |
| An Overview of the Retrofit Potential of<br>Different Building Types. . . . .                   | 44   | Implications for Retrofit of Buildings in Cities. . . . .       | 87   |
| Building Stock of Cities. . . . .   | 47   | Energy Retrofit Business. . . . .                               | 87   |
| Small Wood Framehouses. . . . .   | 48   | Problems and Opportunities of Urban Retrofit                    | 89   |
| Small Solid Masonry Houses. . . . .   | 52   | Urban Retrofit: Mass production or<br>Custom Work?. . . . .     | 89   |
| Moderate- and Large-Size Multiamily<br>Buildings . . . . .                                      | 53   | Retrofit, Rehab, or Demolish?. . . . .                          | 91   |
| Moderate and Large Commercial Buildings. . . . .  | 56   |   |      |
| Effectiveness of Individual Retrofits for<br>Different Building Types. . . . .                  | 61   |   |      |
| Retrofits to the Building Envelope. . . . .   | 61   |   |      |
| Retrofits to the Mechanical System. . . . .   | 68   |   |      |
| Retrofits to the Domestic Hot Water System. . . . .   | 77   |   |      |
| Retrofits to the Lighting Systems. . . . .  | 78   |   |      |
| Conclusion—variation in Retrofit<br>Applicability by Building Type. . . . .                     | 80   |   |      |
| Energy Savings for Particular Buildings May Be<br>Both Site Specific and Unpredictable. . . . . | 80   |   |      |

| LIST OF TABLES  |      |
|---|------|
| Table No.   | Page |
| 11. Thirteen Types of Buildings With<br>Significantly Different Retrofit Options. . . . . | 44   |
| 12. Types of Housing Found in Central Cities. . . . .                                     | 48   |
| 13. Housing Stock With and Without<br>Wall Insulation and Roof Insulation. . . . .        | 50   |
| 14. Housing Stock With and Without<br>Storm Windows. . . . .                              | 50   |
| 15. Small Framehouse: Sample List of Retrofit. . . . .                                    | 51   |
| 16. Small Masonry Rowhouse: Sample<br>List of Retrofit options. . . . .                   | 52   |

| Table No.   | Page |
|---|------|
| 17. Multifamily Building: Sample List of Retrofit Options. . . . .  | 56   |
| 18. Characteristic Sizes of Commercial Buildings in Downtown Baltimore. . . . .                                     | 59   |
| 19. Large Commercial Buildings: Sample List of Retrofit Options. . . . .  | 60   |
| 20. Calculated Capital Cost of Window Retrofits in Buffalo and Tampa. . . . .                                       | 65   |
| 21. Calculated Capital Costs of Energy Efficiency Retrofits Compared to Active and Passive Solar Retrofits. . . . . | 67   |
| 22. Calculated Capital Cost of Retrofits to Air and Water Mechanical Systems . . . . .                              | 74   |
| 23. Calculated Capital Costs of Four Retrofits to Commercial Lighting Systems . . . . .                             | 79   |
| 24. Energy Use Per Square Foot in Buildings of Downtown Baltimore . . . . .   | 81   |
| 25. Documented Energy Savings by Type of Commercial Building. . . . .   | 84   |
| 26. Summary of Findings From Survey of Commercial Building Retrofits . . . . .                                      | 85   |
| 3A. Building Types for Which Retrofit Lists Were Developed. . . . .   | 92   |
| 3B. Retrofits Assessed by the Office of Technology Assessment. . . . .  | 93   |
| 3C. Characteristics of the 12 Building Types. . . . .   | 94   |
| 30. Assumptions About the Mechanical System Types Used in OTA's Analysis of Retrofit Cost-Effectiveness. . . . .    | 95   |

**FIGURE**

| Figure No.  | Page |
|---|------|
| 10. Heating Systems Found in Owner- and Renter-Occupied Housing Stock in U.S. Central Cities. . . . .   | 50   |
| 11. Heating Systems in Central Cities Housing Stock by Region. . . . .                                  | 50   |
| 12. Air-Conditioning in Central Cities Housing Stock by Region. . . . .                                 | 50   |
| 13. Small, Medium, and Large Multifamily Buildings in Central Cities: U.S. Total and Northeast. . . . . | 54   |
| 14. Electricity Used for Heat in Single-Family and Multifamily Buildings. . . . .                       | 55   |

| Figure No.   | Page |
|--|------|
| 15. Square Footage of Commercial Buildings. . . . .  | 58   |
| 16. Relative Sizes of Various Types of Commercial Buildings. . . . .   | 58   |
| 17. Heating and Air-Conditioning Systems for Commercial Buildings by Year of Construction. . . . .                 | 59   |
| 18. Adding Wall Insulation to Existing Frame Walls and Existing Masonry Walls. . . . .                             | 63   |
| 19. Calculated Costs and Savings: Wall Insulation. . . . .   | 64   |
| 20. Calculated Costs and Savings: Roof Insulation. . . . .   | 64   |
| 21. . . . .  | 65   |
| 22. One Active and Two Passive Solar Devices for Heating Buildings. . . . .  | 66   |
| 23. Five Systems for Adjusting the Amount of Heat and Cooling to Different Zones in a Commercial Building. . . . . | 69   |
| 24. Sample Retrofits to Central Air Heating and Cooling Systems. . . . .   | 72   |
| 25. Sample Retrofits to Water-Based Heating Systems. . . . .   | 73   |
| 26. Calculated Capital Costs of a Modulating Aquastat-Three Building Sizes. . . . .                                | 74   |
| 27. Calculated Capital Costs of Four Mechanical System Retrofits-Three Buildings Sizes. . . . .                    | 75   |
| 28. Calculated Capital Cost of Replacing Window Air-Conditioners in Tampa, St. Louis, and Buffalo. . . . .         | 76   |
| 29. Calculated Capital Costs of Solar Hot Water Heaters and Three Other Hot Water Retrofits . . . . .              | 78   |
| 30. Diagram of Heat Pump Hot Water Heater. . . . .   | 78   |
| 31. . . . .  | 80   |
| 32. Simple Payback Period . . . . .  | 85   |
| 33. Categories of Completed Retrofits: Summary of Commercial Building Retrofits . . . . .                          | 86   |

**LIST OF BOXES**

|  | Page |
|--|------|
| A. The Energy Auditor's Work. . . . .                                    | 41   |
| B. The Cost Effectiveness of Energy Retrofits: Four Definitions. . . . . | 46   |

# Technical Potential for Improving the Energy Efficiency of Buildings in Cities

## INTRODUCTION

The building stock of U.S. cities is inherited from eras of energy use that were very different from the one that the country faces over the next two decades. Some buildings date from the mid-19th century when the only building fuel was firewood and the average home consumed 17 cords per year.<sup>1</sup> Many buildings still have old coal furnaces in their basements, later converted to burn oil. The shiny glass office buildings of the 1960's and early 1970's were built in the expectation of cheap electricity getting cheaper.

How well are these buildings likely to survive as energy prices continue to increase in response to the increasing scarcity of oil and gas? To be sure, those who work and live in old buildings will have the option of using them the way their ancestors did with closed off rooms and lowered temperatures in the winter, windows open, shirtsleeves, and long cool drinks in the summer.

To what extent, however, can the buildings themselves be made more energy efficient in response to higher prices? What specific changes can be made to walls, windows, and heating equipment of different kinds of city buildings to make them more efficient? At what cost compared to savings in energy? With what degree of uncertainty? Are there types of buildings that will never be even moderately frugal in their energy use and so will be prime candidates for abandonment if their energy costs become the dominant expense?

To answer these questions OTA conducted a systematic survey of physical changes that could be made to different kinds of buildings to improve their energy efficiency. For convenience,

these will be called *energy retrofits* in this report. The analysis used methods of calculation of costs and savings that are somewhat more sophisticated than those of many energy auditors (see box A) but are generally simpler than calculation methods used in some elaborate computer programs. For some retrofits and some building types there have been individual

### Box A.-The Energy Auditor's Work

**The energy auditor's work has two components: a theoretical component and a site-specific component. In the theoretical component, the auditor takes a small number of facts about a building's walls, windows, roof, lighting, and mechanical systems and applies a series of formulas to estimate the amount of energy savings that might result from each of several retrofit measures. He estimates the cost of the components, also based on standard cost information.**

**The auditor subsequently, or simultaneously, inspects the building and discusses it with its owner in order to take into account several additional factors which are peculiar to the building and the owner's plans for it. The auditor, in this site-specific component will:**

- **make a precise assessment of the efficiency of the current mechanical system components;**
- **identify any peculiar features of the building that waste energy, such as cracks around vents that release heat to the outside;**
- **identify any peculiar local variations in the cost of labor or materials; and**
- **take into account the owner's plans for renovating or repairing such features as the roof or mechanical systems that would be affected by a retrofit.**

<sup>1</sup>*Energy in the American Economy, 1850-1975: An Economic Study of Its History and Prospects*, Sam H. Schurr and Bruce Netscher, with Vera F. Eliasberg, Joseph Lerner, Hans H. Landsberg, Resources for the Future, Inc., 1977, p. 49.

studies that provide more detail than the comprehensive survey of retrofits described in this chapter, but these do not provide ways to compare retrofits across building types. Where applicable these studies are referenced or described in the text and in footnotes. z

The data on actual retrofits are skimpy and do not permit any conclusions comparing savings from one category of retrofits to another or comparing one building type to another. These data are reported on later in the chapter.

The data on the nature of the building stock are also skimpy. Although much is known about the location, size, structure, and heating systems of the housing stock and the rate of new construction and demolition, until this year virtually nothing was known about the commercial building stock. Now, thanks to a survey of nonresidential (mostly commercial but a few industrial) buildings\* something is known about the size, use, and heating and cooling systems of commercial buildings but still very little about their location (in central cities, suburbs, or rural areas) or the rate at which they are being constructed or demolished. This chapter, where possible, relates data on characteristics of the building stock, which are expected to affect its retrofit potential.

**On the average, retrofits to existing buildings of most types are practical, feasible, and have a low capital cost compared to savings. At the same time, however, there is a large margin of uncertainty and risk about the savings achievable in a particular building. This is due both to the early stage of development and** use of retro-

fits to buildings, and to some inherent lack of predictability for a technology applied in hundreds of thousands of buildings each with its own special characteristics. The chapter is organized to present the information to demonstrate these two overall conclusions. The first part of the chapter is devoted to the theoretical differences among buildings that systematically influence their retrofit potential. The second part of the chapter describes the reasons why energy savings for a particular building may be unpredictable.

The chapter also discusses key differences among the retrofit potential of building types that should be taken into account in designing a focused public or private retrofit program. Three of the critical differences are:

1. Which aspects of the *buildings type are most susceptible to retrofit?*—The retrofit business is still fragmented. Different businesses specialize in insulation, storm windows, improvements to the mechanical system, improvements to the hot water system, and improvements to the lighting systems. A designer of a retrofit program should know which businesses should be dealing with which building types.
2. *Is the building type capable on average of substantial/ reductions in energy use?* —This helps determine possible targets of retrofit programs. All programs, public or private, can benefit from early success and satisfied customers. Aiming a retrofit program first at those building types that are most likely to be capable of substantial reductions in energy use is one way to build the credibility of retrofits,
3. *Can a large fraction" of the potential energy savings of the building type be achieved with retrofits of low capital cost relative to savings ?*—For building types with a retrofit potential with this characteristic, financial assistance with the retrofit should not be as necessary as for building types with a large fraction of potential savings likely to come from retrofits of moderate capital cost relative to savings or a large fraction of retrofits with high capital cost relative to savings.

\*Some examples of computer programs to assess retrofits include DOE-2 (formerly Department of Energy), E CUBE (Southern California Gas Co. ) and BLDSIM (Honeywell). For more information see article and bibliography T. Kusuda "Comparison of Energy Calculation Procedures, " *ASHRAE Journal*, August 1981. Two notable studies of the retrofit potential of different categories of buildings are: 1 ) *A Study of Energy Conservation in Rental Housing*, prepared by Ritter, Suppes, Plantz, Architects, Ltd. for the Minnesota Housing Finance Agency, January 1979; and 2) *Energy Conservation in Existing Office Building*, Syska and Hennessy and Tishman Research for the U.S. Department of Energy, New York, June 1977.

\* Published by the Energy Information Administration of the Department of Energy in April 1981.

## A FEW CHARACTERISTICS OF BUILDINGS INFLUENCE THEIR RETROFIT POTENTIAL

The variety of city buildings may seem infinite: from the small brick rowhouses of Baltimore and wooden Victorians of San Francisco to the towering offices of downtown Atlanta. To the trained eye of the energy auditor, however, there are only a few important characteristics of a city building that will determine the kinds of energy retrofit measures that should increase that building's energy efficiency. Three of these characteristics are usually visible from the outside of the building: size, wall and roof type, and building purpose (residential or commercial). A fourth, equally important but invisible to the outside, is mechanical system type. Each of these characteristics will affect the list of retrofit options as follows:

**Size.**—Energy retrofits that improve the tightness of the building envelope are more important for small buildings than for large buildings. Wall insulation, roof insulation, and window treatments such as storm windows save more energy for small buildings than large ones because in small buildings there is more outside surface through which heat and cooling can escape compared to the useful floor area of the building. On the other hand, certain kinds of retrofits to central heating and cooling systems or domestic hot water systems are less expensive for the same savings in large buildings than in small because of economies of scale in equipment size.

**wall and roof type.**—Masonry or clad walls (steel frame with brick, concrete, steel, or glass veneer) and flat roofs without attics or with very small crawl spaces are much more expensive to insulate than are wood frame walls and roofs with attics and ample crawl spaces. Many buildings characteristic of cities—cinderblock bungalows, brick rowhouses, large clad-wall apartment buildings, or stone or brick commercial strip buildings—cannot improve the energy efficiency of their structures through insulation except at great expense.

**Mechanical system (HVAC) type.**—Physical changes to the way space heating and cooling is

produced and circulated can provide significant increases in building efficiency but vary with the type of heating, ventilation, and air-conditioning (HVAC) system used by the building. Air systems that circulate centrally heated and cooled air in various ways provide many opportunities for improved efficiency. Decentralized systems, on the other hand, use individual space heaters and air-conditioning units and generally have improved efficiency only by replacing the individual units at considerable expense. Mixed *water-based systems*, typical of older buildings that heat with circulating hot water and steam through radiators but cool with window air-conditioners, can be retrofit in the central system but share with decentralized systems the problems of retrofitting the air-conditioners. Finally complex reheat systems, typical of newer commercial buildings can have their efficiency greatly improved by changing from a very energy inefficient “reheat” way of maintaining constant temperature to a more efficient one.

**Building purpose.**—Most commercial buildings are used from 9 to 5 (offices) or 9 to 9 (shopping centers) and are empty outside these hours. This provides opportunities for improved energy efficiency by careful control of temperature and lighting between operating and nonoperating hours. Greater ventilation requirements and cooling loads in commercial buildings permit energy savings from careful use of outside air and opportunities also exist for more efficient and task-specific lighting in commercial buildings. Multifamily buildings on the other hand use a lot of hot water; retrofits to the hot water system can usually save energy. Since multifamily buildings must be comfortable temperatures at night, there are significant opportunities for preventing heat loss through windows at night.

The age of a building was not added to this set of four critical characteristics because by itself it does not directly influence the list of retrofits that is appropriate to the building. The age of a building is, rather, an indicator of the other



characteristics of the building which will directly affect its retrofit potential. Older buildings are more likely to have solid masonry walls and central water or steam heating systems. Rather than central air-conditioning they are likely to have window air-conditioners, or none at all.

An older building is also somewhat more likely to have inefficient heating systems and poorly fitting window frames subject to infiltration. However, old buildings may also be carefully maintained, and equipped with upgraded heating equipment and newly fitted windows,

## AN OVERVIEW OF THE RETROFIT POTENTIAL OF DIFFERENT BUILDING TYPES

**There is a List of Practical Retrofit Options for Each Distinctive Building Type. Most energy auditors prepare their** work in the form of a list of retrofit options that show the cost of each option, estimated savings, and expected pay-back. Although retrofit lists were initially constructed for over 40 combinations of the four building characteristics described above, it was found that 13 sets of building characteristics (see table 11) were enough to explain most of the the variation among the retrofit lists. Some sample lists for some building types are presented later in the chapter (tables 15, 16, 17, and 19).

The retrofit lists were constructed from a total list of almost 40 retrofits. The 13 distinct building types consist of:

- three types of small framehouses of one to four dwelling units (distinguished by their mechanical systems);
- three types of small masonry rowhouses also distinguished by their mechanical systems;
- three types of moderate or large multifamily buildings; and
- four types of moderate or large commercial buildings.

**Table 11.—Thirteen Types of Buildings With Significantly Different Retrofit Options**

| Building type and wall type                                    | Mechanical system type            | More energy savings from                       |   |
|--|-----------------------------------|--|---|
|  |                                   | Low capital cost retrofit package <sup>a</sup> | Moderate capital cost retrofit package <sup>a</sup> |
| Small house with frame walls (single family or 2-4 units)      | Central air system                | X  | .   |
|  | Central water system <sup>b</sup> | X  | —   |
|  | Decentralized system              | x  | —   |
| Small rowhouse with masonry walls (single family or 2-4 units) | Central air system                | —  | X   |
|  | Central water system              | —  | X   |
|  | Decentralized system              | —  | x   |
| Moderate or large multifamily building (masonry or clad walls) | Central air system                | x  | —   |
|  | Central water system              | x  | —   |
|  | Decentralized system              | —  | x   |
| Moderate or large commercial building (masonry or clad walls)  | Central air system                | x  | .   |
|  | Central water                     | —  | x   |
|  | Complex reheat system             | x  | —   |
|  | Decentralized system              | x  | —   |

<sup>a</sup>See app. B at the end of the report for details on retrofit packages for the different building types.  
<sup>b</sup>OTA's assumption is that this building type has a central water system and window air-conditioners.  
 SOURCE: Office of Technology Assessment.

A complete listing of the full set of building types and of the full list of retrofits analyzed can be found at the end of the chapter in appendixes 3A and 3B.

**For Almost All of the 13 Building Types the Retrofit Lists Contain Predominantly Retrofit Options of Low Capital Cost Compared to Savings.** OTA classified retrofits on each list into low, moderate, and high capital cost compared to savings. To accommodate several common methods used by energy and housing analysts to express cost effectiveness, OTA has translated its definition of low capital cost compared to savings into three other ways of expressing cost effectiveness (see box B). The retrofit options of low capital cost on the retrofit lists are those that cost less than \$14 for each annual million Btu that they save, which are expected to pay back in less than 2 years, earn an annual real return of at least 50 percent per year for 20 years, and cost less than \$3.50 per million Btu saved at a capital recovery rate of **25** percent. Any way that one looks at their cost effectiveness, such retrofits are very good investments and are not likely to pose serious financing problems.

The sample retrofit lists for each of the 13 building types are shown in appendix A at the end of this report. A number of very powerful low-cost retrofits are responsible for a large share of the low-cost energy savings on each list: roof insulation for small buildings, wall insulation for frame buildings, reduction of ventilation and economizer cycles for commercial buildings with air systems, conversion from incandescent to hybrid fluorescent lamps in those commercial buildings still equipped with incandescent lights, and flow controllers and hot water system insulation in multifamily buildings.

All of the retrofit lists have on them substantial numbers of retrofits of moderate capital cost compared to savings. Such retrofits pose more serious financing difficulties for building owners no matter how the capital cost is expressed. Using OTA's definition and three other ways of expressing capital cost (see box B) moderate capital cost retrofits cost between \$14 and \$49 for each annual million Btu saved and would pay back in 2 to 7 years. They would earn more

than 13 percent but less than 50 percent in annual real return per year over 20 years. If annualized at a capital recovery rate of 25 percent (corresponding to a 5-year loan at the fairly low interest rate of 10 percent) these retrofits would cost between \$3.50 and \$12.75 per annual million Btu saved. Some retrofits of moderate capital cost compared to savings include: storm windows for small buildings, shading devices for commercial buildings, and window insulation at night for multifamily buildings.

There are also a few retrofits with high capital cost compared to savings on each list but they are only important for a few building types. High capital cost retrofits pose very serious financing problems. They are not expected to payback for 7 to 15 years and are expected to earn less than 13 percent per year real return on investment. An outstanding example of a high capital cost retrofit that achieves substantial energy savings is wall insulation for masonry-walled buildings.

**When Individual Retrofit Options Are Combined Into Retrofit packages, the Cumulative Savings is Significantly Less Than the Sum of the Savings From Individual Retrofits.** Many of the low and moderate capital cost retrofits (which are the first that any cost-minded building owner is likely to install) reduce the potential for savings for some or all retrofits installed later. For example, storm windows reduce the amount of heat that escapes from windows. Savings from nighttime insulating window shades will be greater if installed on windows without storm windows than on those already equipped with storm windows.

For this reason savings from individual retrofits on the retrofit option lists cannot be added together. The energy savings produced when these retrofits are combined into packages is significantly less than the sum of what savings each would be expected to produce by itself. Because of the dozens of ways in which individual retrofits can be combined, each of which will produce a separate estimate of cumulative savings, most auditors generally calculate combined savings for one or a few retrofit packages.

**Box B.—The Cost Effectiveness of Energy Retrofits: Four Definitions**

This is an easy reference for translating the measure of retrofit cost effectiveness used by OTA (retrofit cost per annual Btu saved) into three other expressions of cost effectiveness. Each requires more assumptions than the simple cost per million Btu. The three other ways are shown below and compared to the cost per million Btu shown at left.

| Capital cost compared to savings | OTA's method   | Simple payback assuming                       |  |
|----------------------------------|--|---|--|
|                                  | Total cost of retrofit per annual million Btu saved* | Value of energy savings = \$7 per million Btu | Value of energy savings = \$4.50 per million Btu |
| Low capital cost                 | \$ 7.00<br>\$ 1400                                   | 1 Yr.<br>2 Yrs.                               | 1 ½ Yrs.<br>3 Yrs.                               |
| Moderate capital cost            | \$ 21.00<br>\$ 35.00<br>\$ 49.00                     | 3 Yrs.<br>5 Yrs.<br>7 Yrs.                    | 4 ½ Yrs.<br>8 Yrs.<br>11 Yrs.                    |
| High capital cost                | \$ 70.00<br>\$10500                                  | 10 Yrs.<br>15 Yrs.                            | 15½ Yrs.<br>23 Yrs.                              |

**Simple payback**, often used by energy auditors in dealing with their clients, is defined as the number of years for the first year's annual dollar value of energy savings to equal the cost of the retrofit. Simple payback does not take into account fuel escalation nor discount for future years. In addition to the cost per million Btu of the retrofit this measure requires an assumption about the value of fuel savings. In the example at the left, a low capital cost retrofit will have a simple payback of 2 years if the value of the first year savings is high because fuel oil is being saved, but will have a simple payback of 3 years if the lower cost natural gas is being saved.

| Capital cost compared to savings | OTA's method   | Real return on Investment assuming.         |                             |
|----------------------------------|--|---|-----------------------------|
|                                  | Total cost of retrofit per annual million Btu saved* | Measure lifetime = 5 years (annual percent) | Measure lifetime = 20 years |
| Low capital cost                 | \$ 7.00<br>\$ 14.00                                  | 97%<br>41%                                  | 100%<br>50%                 |
| Moderate capital cost            | \$ 21.00<br>\$ 35.00<br>\$ 49.00                     | 20%<br>0<br>Loss                            | 33%<br>19%<br>13%           |
| High capital cost                | \$ 70.00<br>\$10500                                  | Loss<br>Loss                                | 8%<br>3%                    |

**Real return on investment**, used in business and real estate decisionmaking, takes into account the life of the retrofit measure and is defined as the real discount rate that equates costs and savings. In the example at left, a moderate capital cost retrofit costing \$35.00 per annual million Btu saved will provide a 19 percent real return on investment if it lasts 20 years, but no return at all if it lasts only five years.

| Capital cost compared to savings | OTA's method   | Cost of conserved energy assuming                  |                               |
|----------------------------------|--|--|-------------------------------|
|                                  | Total cost of retrofit per annual million Btu saved* | Capital recovery rate of 0.07 (\$ per million Btu) | Capital recovery rate of 0.25 |
| Low capital cost                 | \$ 7.00<br>\$ 14.00                                  | \$0.47<br>0.94                                     | \$ 1.75<br>3.50               |
| Moderate capital cost            | \$ 21.00<br>\$ 35.00<br>\$ 49.00                     | 1.41<br>2.35<br>3.28                               | 5.15<br>8.75<br>12.25         |
| High capital cost                | \$ 70.00<br>\$10500                                  | 4.70<br>7.04                                       | 17.50<br>26.25                |

**Annualized cost of conserved energy** is often used when comparing the cost of new energy supplies to the cost of conserving energy. It requires an assumption about a capital recovery rate in order to translate a one-time capital expenditure into annual expenses. In the example at left, the cost of conserved energy of a moderate capital cost retrofit of \$49.00 per annual million Btu saved will be \$3.28 per million Btu if capital is recovered at a capital recovery rate of 0.067 per year. (This corresponds to a 3 percent rate of interest over 20 years and is the assumption commonly used in lifecycle costing.) The same retrofit will cost \$12.25 per annual million Btu saved at a capital recovery rate of 0.25 per year, (a rate which would amortize a 5-year loan at an annual interest rate of 10 percent).

\*OTA assumes that all end-use Btu of electricity savings are multiplied by 2.46, in order to adjust for the difference in cost per million Btu between fuel at \$1 per gallon (\$7 per million Btu) and electricity at \$0.06 per kWh (\$17 per million Btu).

To illustrate the difference between lists of retrofit options and retrofit packages, the savings from packages of retrofits for each of the 13 distinct building types is calculated. These are shown in appendix B at the end of this report.

**For Five of the Building Types the Bulk of Potential Savings is Likely to Come From Retrofits of Moderate Cost Compared to Savings.**

The owners of such buildings must cope with the difficulties of financing retrofits in order to achieve substantial savings. These building types and the estimate of potential savings from moderate cost retrofits are (see also table 11):

- masonry rowhouse with air system (30 percent),
- masonry rowhouse with water system and window air-conditioners (55 percent),
- masonry rowhouse with decentralized system (70 percent),
- large commercial building with water system and window air-conditioners (50 percent), and
- large multifamily building with decentralized system (**50 percent**).

**Only a Few Building Types Are Expected to Have Substantial Savings From Retrofits of High Capital Cost Compared to Savings.**

For most of the 13 building types a high-cost retrofit package would contribute less than **20** percent of the total savings. This is fortunate because, as box B makes clear, the payback on a high-cost retrofit is very slow.

However, for three building types a high-cost retrofit package compared to savings would be expected to contribute more than 20 percent of

the total potential energy savings. These three building types and the expected contribution of high capital cost retrofits are:

- small masonry rowhouse *with* an air system (high-cost retrofits would contribute 40 percent of the total);
- small masonry rowhouse with a water or steam system (high-cost retrofits would contribute **25 percent of the total**); and
- **multifamily building with an air system** (high-cost retrofits would contribute **30** percent of the total).

For all these building types wall insulation is the most important element of the high capital cost retrofit package. It costs a lot but also saves a lot. For these buildings, public or private programs to facilitate the long-term financing of high-cost measures would help to realize the substantial savings available from high-cost retrofits. For the other 10 building types analyzed, high capital cost measures would contribute little enough that they can be ignored if financing is not easily available.

**The Total Savings Potential of Large Buildings Appears To Be Greater Than That of Small Buildings.**

According to OTA's analysis of total savings potential from retrofit packages, multifamily and commercial buildings have the potential to save .50 to 60 percent of their initial energy use while smaller framehouses and rowhouses have the potential to save 30 to 40 percent. For those commercial buildings still heavily dependent on incandescent lights, the savings potential from retrofit packages that include a shift to more efficient fluorescent lights may go as high as **70** percent of initial energy use.

## BUILDING STOCK OF CITIES

What then are the prospects for improved energy efficiency in the building stock of U.S. cities? Each of the sections that follows describes the nature and general retrofit potential of one of the four major categories of the city building stock: small framehouses, small mason-

ry rowhouses, moderate to large multifamily buildings, and moderate to large commercial buildings. A few additional types of buildings, e.g., freestanding masonry houses and very small commercial buildings, are also dealt with briefly.

The four categories of buildings include all 13 building types shown in table 11. Each of the four structural types (e.g., small framehouse) is further subdivided into mechanical system types because it is the mechanical system types which, especially in larger buildings, influence the retrofit potential of the building,

### Small Wood Framehouses

Contrary to common perceptions about cities, the most typical building in a U.S. central city is the small wood framehouse. More than 16 million (see table 12) of the 25 million housing units in U.S. central cities are single-family detached houses (about 11 million) or are in buildings of two to four apartments (about 5 million). of these, it is estimated that a very large majority (80 to 90 percent) are buildings of wood frame construction, although there is no precise breakdown of the housing stock between wood frame and solid masonry. In four out of five of the case study cities visited—Buffalo, N. Y.; Des Moines, Iowa; Tampa, Fla., and San Antonio, Tex.—the basic housing stock is of wood. only in a fifth case study, Jersey City, N. J., is masonry construction important. Half of the dwelling units in Buffalo's wooden houses are found in buildings of two to four apartments.

OTA found that the lists of retrofits applicable to such buildings is influenced by their small size (arbitrarily defined at less than **4,000 ft<sup>2</sup>**) and **wall construction**. From an energy auditor's point of view the important characteristic of this

type of housing is that the wood studs of the building frame provide a cavity into which wall insulation can be blown. Since the wood frame can be used to support a variety of wall types the external appearance of a wood framehouse may vary. The outer wall is most commonly of wood siding but it may also be of brick or stone veneer, or concrete blocks with and without stucco finish—a housing structure common in the South and southwest regions of the country.

The lists of retrofits most effective for such buildings are also influenced by their type of heating and cooling system. Retrofits for small wood framehouses with central air heating and cooling will differ from those with *central water or steam heat and window air-conditioners* and also differ from those with *decentralized heating and cooling systems* (electric baseboard heaters, heat pumps, gas heaters, wood stoves, or fireplaces). The likelihood of finding different types of heating and cooling systems in different types of housing is shown in figures 10, 11, and 12. Warm air heating systems are more common in owner-occupied housing (mostly single-family detached) and in regions outside the Northeast. Water and steam systems provide the heat in more than two-thirds of the housing units of the Northeast. Room air-conditioning units are still the dominant form of cooling except in the South. More than half of all the housing units in the Northeast and West have no air-conditioning at all.

OTA's list of typical retrofits for wood framehouses assumes that the retrofits are applied to

**Table 12.—Types of Housing Found in Central Cities**

| Type  | Central city housing stock |                  | U.S. housing stock         |                  |
|---|----------------------------|------------------|----------------------------|------------------|
|   | Number of units (millions) | Percent of total | Number of units (millions) | Percent of total |
| Single-family detached . . . . .            | 10.9                       | 43 %             | 52.4                       | 63.0             |
| Single-family attached . . . . .            | 1.5                        | 6                | 3.1                        | 4                |
| 2-4 unit buildings . . . . .                | 5.3                        | 21               | 10.8                       | 13               |
| Buildings with five or more units . . . . . | 7.2                        | 29               | 12.9                       | 16               |
| Mobile homes . . . . .                      | 0.2                        | 1                | 3.7                        | 4                |
| Total . . . . .                             | 25.2                       | 100%             | 82.8                       | 100 %            |

NOTE: Details may not add to total due to rounding.

SOURCE: HUD, *Annual Housing Survey*, 1978.



Photo credits: OTA staff

More than half of the housing stock of U.S. central cities are small detached framehouses. These come in many forms: bungalows (as in Tampa, Fla., upper left), triple-deckers (as in Waterbury, Conn., lower left), set close together (as in San Francisco, Calif., upper right) or set well apart (as in Des Moines, Iowa, lower right). Lists of retrofit options will be similar for framehouses with similar heating and cooling systems

an uninsulated house. While more than half of the housing stock as a whole has wall insulation (50 percent), roof insulation (59 percent), and all windows covered with storm windows (41 percent), there is reason to believe that the older central city building stock is less well-insulated than the building stock as a whole. Two-thirds of the buildings with two to four units, which comprise about one-third of the Central city building stock, either don't have wall or roof insulation or don't know if they have (see tables 13 and 14).

A sample retrofit list for one type of small framehouse is shown in table 15. This type has a

central water (or steam) system for supplying heat and window air-conditioners for cooling. The most powerful retrofits on this list would increase the efficiency of the building envelope. These are roof and wall insulation and storm windows. Retrofits to the mechanical system are also powerful—setback thermostat, stack heat reclaimer, vent damper, etc.

Sample retrofit lists for two other types of small framehouses—with central air system and with decentralized heating and cooling—can be found in appendix A at the end of this report. Envelope retrofits are also the most powerful retrofits on these two lists. In addition, the

**Figure 10.— Heating Systems Found in Owner- and Renter-Occupied Housing Stock in U.S. Central Cities**

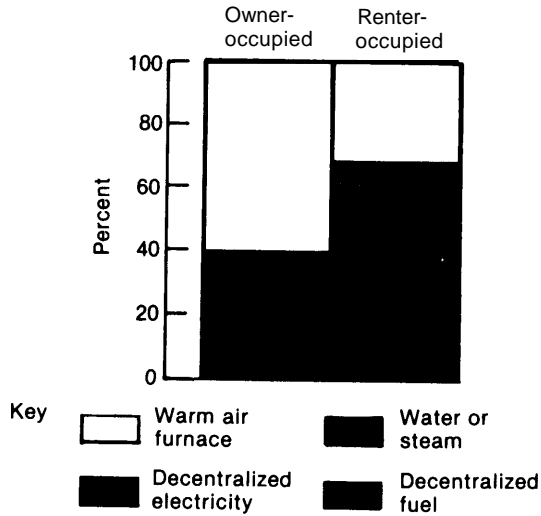

SOURCE: Energy Information Administration, *Characteristics of the Housing Stock and Households: Preliminary Findings From the National Interim Energy Consumption Survey*, October 1979.

**Figure 11.— Heating Systems in Central Cities Housing Stock by Region**

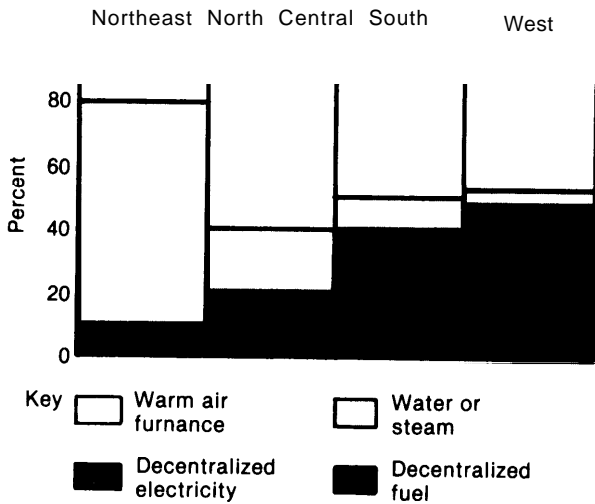

SOURCE: Energy Information Administration, *Characteristics of the Housing Stock and Households: Preliminary Findings From the National Interim Energy Consumption Survey*, October 1979.

**Figure 12.— Air-Conditioning in Central Cities Housing Stock by Region**

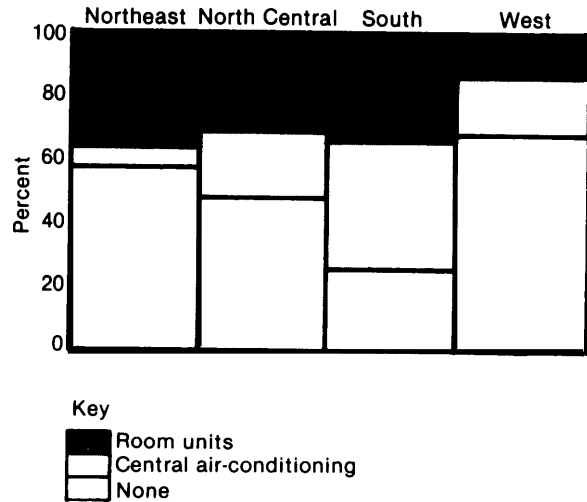

SOURCE: Energy Information Administration, *Characteristics of the Housing Stock and Households: Preliminary Findings From the National Interim Energy Consumption Survey*, October 1979.

**Table 13.—Housing Stock With and Without Wall Insulation and Roof Insulation (in percent)**

|                                     | Yes | No  | Don't know |
|-------------------------------------|-----|-----|------------|
| <b>Building has wall insulation</b> |     |     |            |
| All housing units 1-4 units         | 50% | 27% | 22%        |
| Single-family detached              | 54  | 17  | 17         |
| Single-family attached              | 44  | 28  | 28         |
| Buildings with 2-4 units            | 28  | 27  | 44         |
| <b>Building has roof insulation</b> |     |     |            |
| All housing units 1-4 units         | 69  | 19  | 12         |
| Single family detached              | 77  | 17  | 6          |
| Single family attached              | 53  | 26  | 21         |
| Buildings with 2-4 units            | 35  | 29  | 36         |

SOURCE: EIA Survey of Residential Energy Consumption, February 1980.

**Table 14.—Housing Stock With and Without Storm Windows (in percent)**

|                               | All windows covered | Some windows covered | No windows covered |
|-------------------------------|---------------------|----------------------|--------------------|
| • All housing units 1-4 units | 41 %                | 20 %                 | 39 %               |
| • Single-family detached      | 41                  | 22                   | 37                 |
| • Single-family attached      | 55                  | 11                   | 34                 |
| • Buildings with 2-4 units    | 39                  | 18                   | 43                 |

SOURCE: EIA Survey of Residential Energy Consumption, February 1980.

**Table 15.—Small Framehouse:<sup>a</sup> Sample List of Retrofit Options**

| Retrofit                                | Category   | Total retrofit cost (dollars) | Total energy savings <sup>b</sup> (million Btu) | Capital cost per annual million Btu saved (dollars) |
|---|------------|-------------------------------|---|---|
| <b>Low capital cost</b>                 |            |                               |   |   |
| Roof insulation . . . . .               | Envelope   | 565                           | 40  | Low (13)  |
| Wall insulation . . . . .               | Envelope   | 650                           | 110   | Low (6)   |
| Weatherstripping . . . . .              | Envelope   | 110                           | 9   | Low (12)  |
| Setback thermostats . . . . .           | Mechanical | 135                           | 25  | Low (6)   |
| Modulating aquastat . . . . .           | Mechanical | 250                           | 25  | Low (10)  |
| Hot water flow controls . . . . .       | Hot water  | 20                            | 15  | Low (1)   |
| Insulate hot water storage. . . . .     | Hot water  | 30                            | 7   | Low (4)   |
| <b>Moderate capital cost</b>            |            |                               |   |   |
| Storm windows . . . . .                 | Envelope   | 990                           | 40  | Moderate (25)                                       |
| Vent damper . . . . .                   | Mechanical | 225                           | 10  | Moderate (25)                                       |
| Replace burner . . . . .                | Mechanical | 880                           | 20  | Moderate (46)                                       |
| Stack heat reclaimers . . . . .         | Mechanical | 875                           | 25  | Moderate (36)                                       |
| Replace room air-conditioners . . . . . | Mechanical | 890                           | 55  | Moderate (16)                                       |
| Hot water vent damper. . . . .          | Hot water  | 150                           | 6   | Moderate (25)                                       |
| <b>High capital cost</b>                |            |                               |   |   |
| Window insulation . . . . .             | Envelope   | 910                           | 15  | High (61)   |

**NOTE:** Savings should not be added. See app. B for estimates of cumulative savings.

<sup>a</sup>2,000 sq ft building with frame walls and central water or steam system with window air-conditioners in the St. Louis climate.

<sup>b</sup>Electricity savings are multiplied by a factor of 246 to reflect the difference between the cost of fuel (oil) at \$7 per million Btu and the cost of electricity at \$17 per million Btu for electricity priced at \$0.06 per kWh.

SOURCE: Office of Technology Assessment

retrofit list for the building with the air system has several retrofits suitable only to an air system (and does not include retrofits suitable to water systems). Because all retrofits to the house with decentralized (electric) heating and cooling save expensive electricity, they are each more cost effective than comparable retrofits to the other two types of small framehouses.

Because of specific assumptions used in compiling the list of retrofits for the three types, two important additional types of small framehouse are not directly covered in the above lists of retrofits. One type is the partially *insulated wood framehouse*. For most such houses it is probable that more roof insulation can be added and possible that more wall insulation can be added. In one recent estimate, adding insulation to a partially insulated roof was calculated to cost about three times as much for each annual million Btu saved as adding roof insula-

tion to an uninsulated houses Under these conditions, adding roof insulation is a moderate capital cost retrofit rather than a low-cost retrofit compared to savings.

Another type of small framehouse not strictly covered in the lists of retrofits, is the house with *decentralized heating systems using oil or gas rather than electricity*. These are a large fraction of the housing units especially in the West and South (see fig. 11). The list of retrofit options would be similar to the list for houses with decentralized electricity but since saving oil or gas is worth less money than saving electricity, fewer retrofits for this type of building would be of low or moderate capital cost compared to savings.

<sup>c</sup>Solar Energy Research Institute (SERI), *Report on Building a Sustainable Future*, vol. 2, published by the U.S. House of Representatives Committee on Energy and Commerce, April 1981, p. 96.



### Small Solid Masonry Houses

Only about 1.5 million buildings in U.S. central cities are single-family attached houses and almost half of these are in the central cities of the Northeast.<sup>4</sup> Virtually all rowhouses are made of solid brick or stone walls to prevent the spread of fires. A large fraction of the buildings with two to four housing units are also masonry attached buildings; such buildings form the bulk of the building stock in the case study city, Jersey City, N.J. A much smaller fraction of the single-family detached houses are also of solid masonry walls. Brick or stone rowhouses are typical of the building stock in the Mid-Atlantic States, in such cities as Philadelphia or Reading, Pa. Both detached masonry houses and masonry rowhouses can be found in the older cities of the Southeast and detached houses of solid cinderblock construction are common in the South and Southwest.

From an energy auditor’s point of view the main characteristics of these buildings that affect the list of retrofit options available to them are their small size and the wall construction

<sup>4</sup>In the central cities of the Northeast there are 743,000 attached houses. Source: HUD *Annual Housing Survey*, 1978.

type that has *no cavity* into which wall insulation can be inserted. Furthermore, rowhouses often have flat roofs with crawl spaces that are somewhat harder to insulate than the peak roofs common in wood framehouses. The lists of retrofits are also influenced by the three types of *heating and cooling systems* that were distinguished above for small wood framehouses.

A sample list of retrofit options for a small masonry rowhouse is shown in table 16 for a building with central air heating and cooling. Several things are worth noting in this list. Envelope retrofits are still very powerful but less cost effective than similar retrofits for frame buildings. Roof insulation costs substantially more per annual million Btu saved, although it still fits within the low capital cost category. Wall insulation is a high capital cost retrofit for this type of building. Because of the relative expense of envelope retrofits, retrofits to the hot water and mechanical systems for this building look relatively more attractive.

Retrofit lists for two other types of masonry rowhouses—one with a water heating system and window air-conditioners and one with decentralized heating and cooling—are shown in appendix A. They are similar to the list in

**Table 16.—Small Masonry Rowhouse:<sup>a</sup> Sample List of Retrofit Options**

| Retrofit                              | Category   | Total retrofit cost (dollars) | Total energy savings <sup>b</sup> (million Btu) | Capital cost per annual million Btu saved (dollars) |
|---------------------------------------|------------|-------------------------------|---|---|
| <b>Low capital cost</b>               |            |                               |   |   |
| Weatherstripping . . . . .            | Envelope   | 60                            | 7   | Low ( 9)  |
| Roof insulation . . . . .             | Envelope   | 690                           | 50  | Low (13)  |
| Setback thermostats . . . . .         | Mechanical | 135                           | 15  | Low ( 9)  |
| 2-speed fans . . . . .                | Mechanical | 80                            | 15  | Low ( 5)  |
| Hot water flow controls . . . . .     | Hot water  | 20                            | 15  | Low ( 1)  |
| Insulate hot water storage, . . . . . | Hot water  | 30                            | 7   | Low ( 4)  |
| <b>Moderate capital cost</b>          |            |                               |   |   |
| Storm windows . . . . .               | Envelope   | 450                           | 20  | Moderate (21)                                       |
| Vent damper . . . . .                 | Mechanical | 225                           | 6   | Moderate (38)                                       |
| Hot water vent damper. . . . .        | Hot water  | 150                           | 6   | Moderate (25)                                       |
| <b>High capital cost</b>              |            |                               |   |   |
| Wall insulation . . . . .             | Envelope   | 4,700                         | 40  | High (1 14)   |
| Window insulation . . . . .           | Envelope   | 420                           | 8   | High ( 53)  |
| Insulate ducts . . . . .              | Mechanical | 810                           | 15  | High ( 54)  |

NOTE: Savings should not be added. See app. B for estimates of cumulative savings.

<sup>a</sup>2,000 ft<sup>2</sup> building with frame walls and central water or steam system with window air-conditioners in the St. Louis climate.

<sup>b</sup>Electricity Savings are multiplied by a factor of 2.46 to reflect the difference between the cost of fuel (oil) at \$7.00 per million Btu and the cost of electricity at \$1700 per million Btu for electricity priced at \$0.06/kWh.

SOURCE: Office of Technology Assessment.

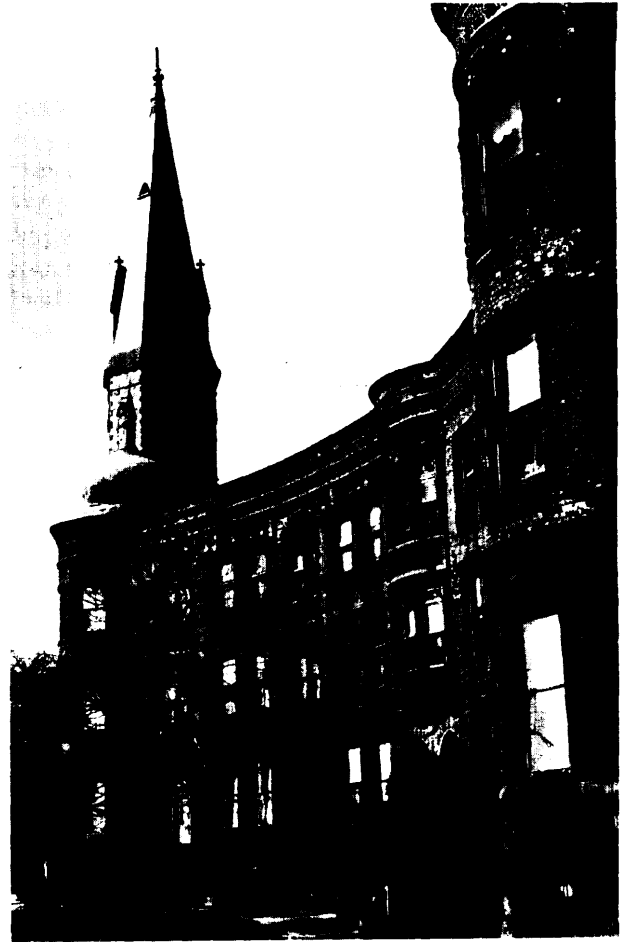

Photo credit: OTA staff

Masonry rowhouses can come plain (as in Lancaster, Pa.) (upper left), or fancy (as in Bridgeport, Conn.) (right), and are typical of the central city housing stock in the middle Atlantic States. One-story detached cinderblock of masonry houses (such as this one in Gainesville, Fla.) (lower left) are characteristic of cities in the South. Lists of retrofit options will be similar for small masonry houses with similar heating and cooling systems

table 16 in that wall insulation is very high capital cost and roof insulation costs more per million Btu saved than in frame buildings. The differences among the lists are similar to those explained above for the small framehouse. The list for the building with the water system and window air-conditioners has some retrofits suitable to that mechanical system type. For the building with decentralized (electric) heating and cooling, hot water retrofits are relatively more cost effective because they save electricity

rather than oil or natural gas. A hot water heat pump is an especially effective retrofit for this kind of building.

These lists of retrofit options for masonry rowhouses are not precisely applicable to small detached *masonry houses* of cinderblock, stone, or brick. With four unattached walls instead of two, the energy demands for heating and cooling detached buildings will be greater. Wall insulation, however, will still be a very expensive retrofit.

### Moderate- and Large-Size Multifamily Buildings

Multifamily buildings with more than 10 units provide slightly less than one-half of all central city housing in buildings with more than one family, and less than one fifth of all housing in U.S. central cities. There are no data on the size of multifamily buildings. Using data on the size of the average apartment, it is estimated that multifamily buildings of 10 to 19 units average 10,000 ft<sup>2</sup> and those of more than 50 units average 44,000 ft<sup>2</sup>. There appear to be fewer very large multifamily buildings than commercial buildings. Buildings with more than 50 units provide 18 percent of all multifamily central city housing in the United States as a whole but a much greater fraction of the multifamily housing of the Northeast (27 percent) (see fig. 13).

For purposes of developing lists of retrofits, the important characteristics of multifamily buildings of this type are their size (arbitrarily defined as more than 10,000 ft<sup>2</sup>) and use. Multifamily buildings compared to commercial buildings of the same size require more heating and cooling at night and use a lot more energy for hot water. Because of these characteristics, lists of retrofits for dormitories and hotels will resemble those for multifamily buildings. Lists of retrofit options for condominium buildings will be the same as lists of options for the same building types occupied by renters.

A third important characteristic is wall type. Included in this type are multifamily buildings with solid masonry walls characteristic of the older densely settled parts of major cities such as Chicago and New York and load walls (steel frame with concrete or brick veneer) characteristic of many new large high rises in the downtowns of U.S. cities (as well as the close-in suburbs).

The type of heating and cooling system is also important for developing the lists of retrofit options for multifamily buildings. There are no complete data on types of heating systems for larger multifamily buildings. More of them, however, use electricity for heat (31 percent) than do smaller buildings, as shown in figure 14. Data shown earlier (figs. 10 and 11) indicate that

Figure 13.—Small, Medium, and Large Multifamily Buildings in Central Cities: U.S. Total and Northeast

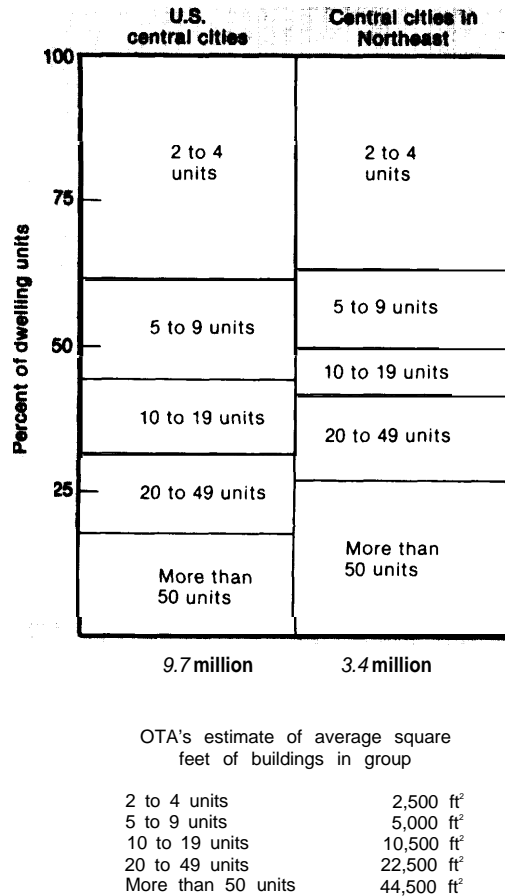

SOURCE: Office of Technology Assessment

both rental units in central cities and housing in the central cities of the Northeast are much more likely to have a water or steam system. Since large multifamily buildings are a substantial fraction of both rental units and of Northeast rental housing it is estimated that at least 20 to 30 percent of large multifamily buildings have central water or steam heat.

A sample list of retrofit options for a large multifamily building with decentralized (electric) heating and cooling is shown in table 17. Such buildings are characteristic of the most recently constructed multifamily buildings in

Figure 14.—Electricity Used for Heat in Single-Family and Multifamily Buildings



Photo credit. OTA staff

Large multifamily buildings with masonry clad walls (such as this condominium in Tampa, Fla.) (top), or middle-sized solid masonry walkups (such as these in Hoboken, N. J.) (bottom) will have similar lists of retrofit options if they have similar heating and cooling systems



SOURCE: EIA Survey of Residential Energy Consumption, February 1980

U.S. cities partly because they facilitate individual metering of utilities so that electricity bills can be paid by apartment tenants rather than the building's owner (see the discussion of tenant-metered buildings in ch. 4). Because all retrofits save electricity, all savings for this building have been increased by a multiplier to reflect the higher cost of electricity. (The multiplier has been applied to electricity savings for other building types as well as is explained in the footnotes to tables 15, 16, 17, and 19.)

Owners of large buildings think of retrofit costs in cost per square foot and this list reflects that convention. Roof insulation for this building at **\$0.30/ft<sup>2</sup>** would actually cost about \$30,000 for a building of this size (100,000 ft<sup>2</sup>). Roof insulation is estimated to save about 7,000 Btu/ft<sup>2</sup>/year or about 700 million Btu per year.

**Table 17.—Multifamily Building:<sup>a</sup>Sample List of Retrofit Options**

| Retrofit                                | Category   | Total cost/ft <sup>2</sup> (dollars) | Energy savings/ft <sup>2</sup> (thousand Btu) <sup>b</sup> | Capital cost per annual million Btu saved (dollars) |
|---|------------|--------------------------------------|--|---|
| <b>Low capital cost</b>                 |            |                                      |  |   |
| Roof spray . . . . .                    | Envelope   | <b>0.03</b>                          | 15   | Low (3)   |
| Setback thermostats . . . . .           | Mechanical | <b>0.04</b>                          | 7  | Low (6)   |
| Flow controls . . . . .                 | Hot water  | <b>0.02</b>                          | 31   | Low (0.5)   |
| Insulate hot water storage . . .        | Hot water  | 0.03                                 | 34   | Low (1)   |
| Hot water vent damper . . . . .         | Hot water  | 0.01                                 | 8  | Low (0.5)   |
| Hot water heat pump . . . . .           | Hot water  | 0.14                                 | 40   | Low (3)   |
| Hybrid lamps . . . . .                  | Lighting   | 0.09                                 | 15   | Low (6)   |
| <b>Moderate capital cost</b>            |            |                                      |  |   |
| Roof insulation . . . . .               | Envelope   | <b>0.30</b>                          | 7  | Moderate (41)                                       |
| Weatherstripping . . . . .              | Envelope   | <b>0.05</b>                          | 1  | Moderate (39)                                       |
| Window insulation . . . . .             | Envelope   | 0.25                                 | 8  | Moderate (31)                                       |
| Install heat pumps . . . . .            | Mechanical | 1.08                                 | 22   | Moderate (50)                                       |
| Replace room air-conditioners . . . . . | Mechanical | <b>0.40</b>                          | 15   | Moderate (26)                                       |
| <b>High capital cost</b>                |            |                                      |  |   |
| Wall insulation . . . . .               | Envelope   | 2.16                                 | 27   | High (81)   |

**NOTE: Savings should not be added.**

<sup>a</sup>Large (100,000 ft<sup>2</sup>) multifamily building with masonry walls and decentralized system in the St. Louis climate.

<sup>b</sup>Electricity energy savings are multiplied by 246 to reflect the difference between the cost of fuel (011) at \$7.00 per million Btu and the cost of electricity at \$17.00 per million Btu for electricity at \$0.06 /kWh.

SOURCE: Office of Technology Assessment.

At **\$7** per million Btu that is worth about \$4,900 per year.

Because hot water use is intensive in multifamily buildings and because hot water retrofits for this type of building save electricity, these are the most powerful and cost effective retrofits—all of low capital cost compared to savings.

Lists of retrofit options for the two other types of multifamily buildings—one with a water system and window air-conditioners and one with central air heating and cooling—may be found in appendix A. Hot water retrofits are also important on these lists but not as powerful because they do not save expensive electricity. Retrofits to the mechanical system (as appropriate to either air or water systems) are also very cost effective,

one category of multifamily house that the lists of retrofits does not explicitly cover are the *multifamily houses of in-between size (five to nine units)*. There are about 1.7 million dwelling units in these types of buildings in U.S. central cities. Many are likely to be of wood frame construction; others are likely to be attached masonry buildings. OTA did not calculate lists of retrofits for these buildings and it is not known

whether the lists of retrofit options would be dominated by retrofits to the building envelope (as with small wood frame and masonry houses) or would be dominated by retrofits to the hot water and mechanical systems (as for the large multifamily buildings). Careful analysis and/or systematic retrofitting of such buildings would be needed to make the determination.

### Moderate and Large Commercial Buildings

Of the approximately 4 million commercial buildings in the country as a whole, less than 25 percent are 10,000 ft<sup>2</sup> or larger but these contain more than 60 percent of all the commercial building square footage (see fig. 15). Commercial buildings used for education or lodging tend to run bigger than the average (see fig. 16) while buildings used for retail or services, or food sales tend to run smaller. Office buildings follow the size distribution of all commercial buildings.

The number and relative size of commercial buildings located in central cities is not known (see ch. 2). It is possible to speculate that larger commercial buildings can be found inside cen-

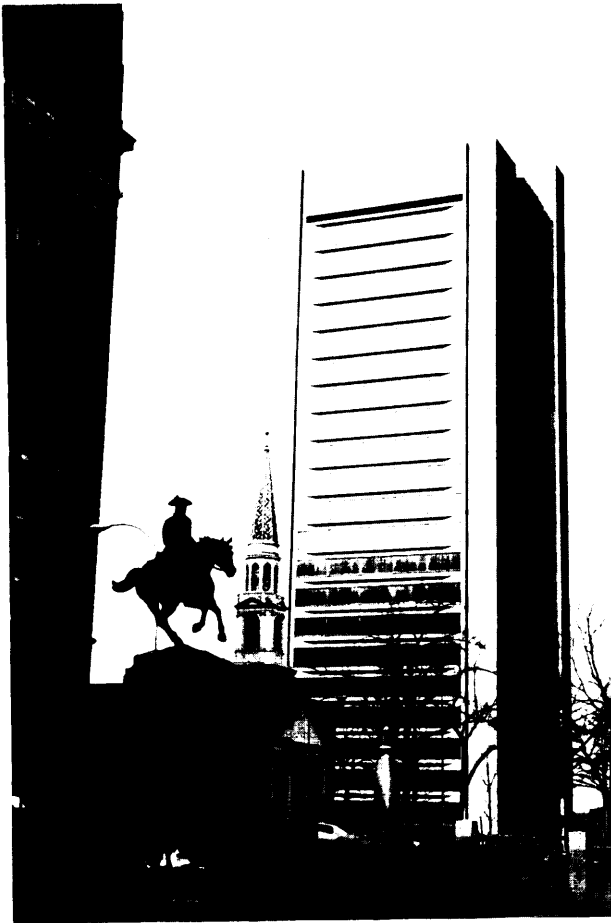

Photo credit: OTA staff

Lists of retrofit options will be similar for diverse types of moderate- and large-sized commercial buildings with similar heating and cooling systems, including: large curtain-wall office buildings (such as these in Wilmington, Del.) (left and top right), middle-sized masonry retail buildings typical of older shopping areas in U.S. cities, or large commercial buildings converted from solid masonry factories and warehouses (such as this shopping center converted from a cigar factory in Tampa, Fla.) (bottom right)

tral cities, Most metropolitan areas have a distinct downtown area of large office buildings, hotels, retail buildings, and government buildings. Large buildings are somewhat more common in the Northeast which has only 17 percent of all commercial buildings but almost 30 percent of the buildings of more than 100,000 ft<sup>2</sup>. OTA identified one survey of commercial buildings in downtown Baltimore, that showed that commercial buildings come in all sizes and for many types of buildings the characteristic size is small (less than 5,000 ft<sup>2</sup>) (see table 18).

From the energy auditor's point of view the characteristics of commercial buildings that affect the list of retrofit options available to them are:

1. moderate *or* large size which diminishes the importance of measures to improve the building envelope;
2. commercial use which means the building uses a lot of energy for lighting and is not normally occupied at night; and
3. wall type.

Figure 15.—Square Footage of Commercial Buildings

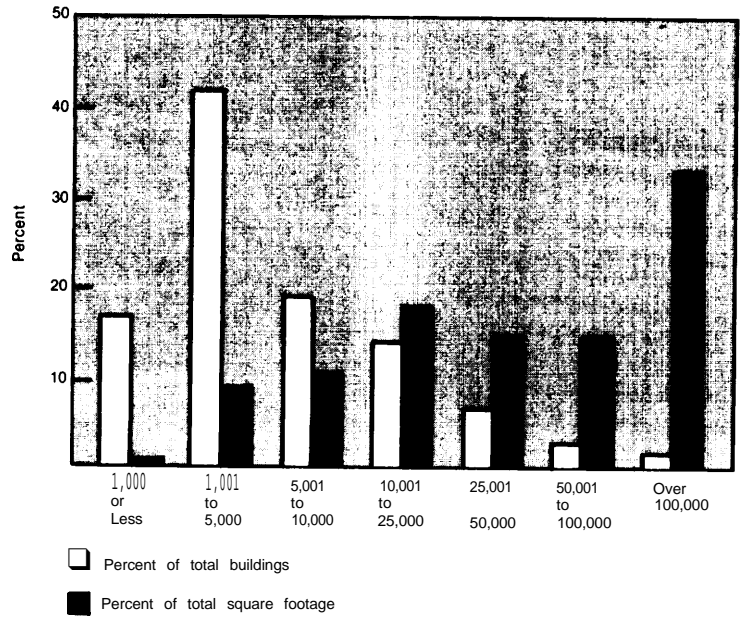

NOTE: Includes about 250,000 industrial buildings out of 4.2 million nonresidential buildings. All the rest are commercial buildings.

SOURCE: Energy Information Administration, Nonresidential Buildings Energy Consumption Survey, Fuel Characteristics and Conservation Practices, June 1981.

Figure 16.—The Relative Sizes of Various Types of Commercial Buildings

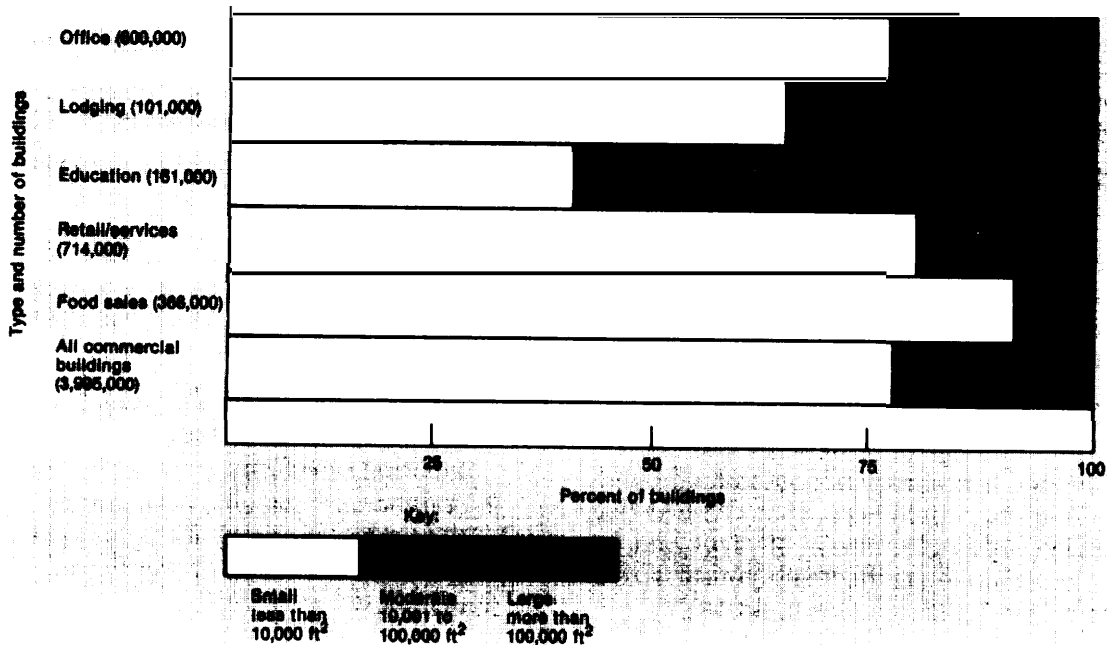

SOURCE: Energy Information Administration, Survey of Nonresidential Buildings: Building Characteristics, and the Office of Technology Assessment

**Table 18.—The Characteristic Sizes of Commercial Buildings in Downtown Baltimore**

| Categories                       | Total range (ft <sup>2</sup> ) | Characteristic size      |                  |
|----------------------------------|--------------------------------|--------------------------|------------------|
|                                  |                                | Range (ft <sup>2</sup> ) | Percent in range |
| Office buildings . . . . .       | 500-552,200                    | 500-4,000                | 49               |
| Motels/hotels . . . . .          | 1,000-235,000                  | None                     | —                |
| Theaters . . . . .               | 500- 13,500                    | None                     | —                |
| Small (general) stores . . . . . | 500- 26,000                    | 500-4,000                | 85               |
| Department stores . . . . .      | 500-142,000                    | None                     | —                |
| Drug stores . . . . .            | 1,000- 19,500                  | 1,000-3,500              | 72               |
| Food stores . . . . .            | 500- 10,000                    | 500,1,500                | 90               |
| Restaurants . . . . .            | 500- 14,500                    | 500-4,000                | 82               |
| Banks . . . . .                  | 500- 31,500                    | 500-3,500                | 61               |
| Personal . . . . .               | 500- 8,000                     | 500-2,000                | 66               |

SOURCE: Hittman Associates, "Physical Characteristics, Energy Consumption and Related Institutional Factors in the Commercial Sector." A report for the Federal Energy Administration, February 1977, p. 51

Although there are no good data available on the structure of commercial buildings, it is concluded from observation that there are very few wood frame commercial buildings of moderate or large size. Virtually all of the moderate- and

large-size commercial buildings are of solid masonry wall construction (typical of low-rise attached commercial buildings in older parts of U.S. cities) or of clad wall construction (steel or concrete frame with a brick, concrete, steel, or glass veneer).

For commercial buildings, the lists of retrofits options are influenced most decisively by the type of heating and cooling system in the building. Retrofits options will differ substantially for commercial buildings with: central air heating and cooling systems, complex reheat systems, central water or steam heat with window air-conditioners, or decentralized heating and cooling systems. The distribution of heating and cooling systems among commercial buildings built in different eras is shown in figure 17. Central air systems are used in more than half the commercial buildings built since 1946. Central

**Figure 17.— Heating and Air-Conditioning Systems for Commercial Buildings<sup>a</sup> by Year of Construction**

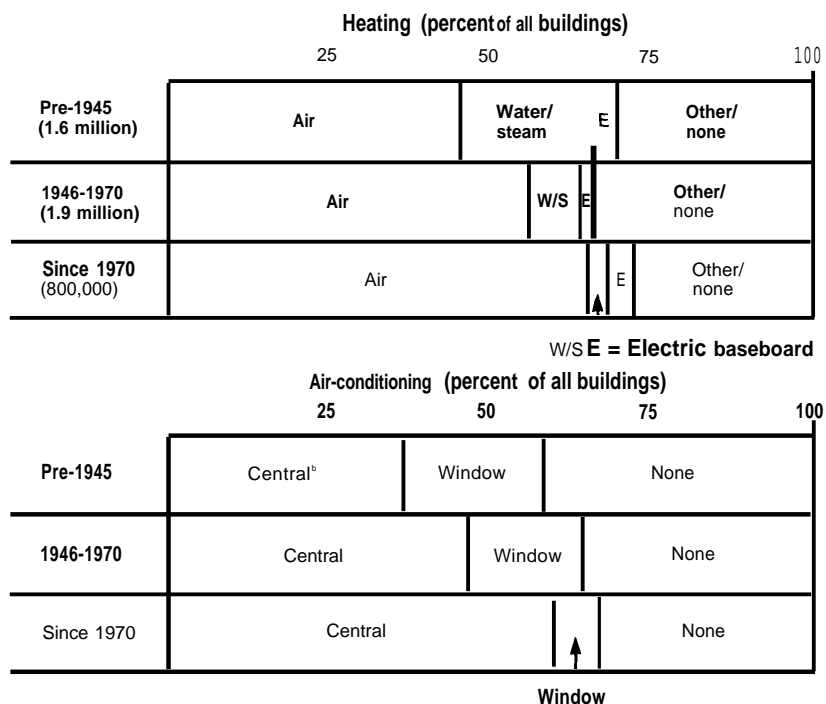

<sup>a</sup>Includes about 250,000 mixed commercial/industrial buildings  
<sup>b</sup>Includes custom-made central, package and combination/other

SOURCE: Energy Information Administration, Survey of Nonresidential Buildings Energy Consumption: Building Characteristics; and the Office of Technology Assessment



water or steam systems are likely to be found only in buildings built before 1945 where they provide heat to 23 percent of the buildings. Decentralized electric systems are rare among commercial buildings as a group but can be found in 4 percent of the buildings built since 1970. The data do not explicitly show complex reheat systems. It is concluded from discussions with energy auditors that these systems are used in large commercial buildings built since 1960. Figure 17 also shows that the share of central air-conditioning has increased to over 50 percent in buildings built since 1970. Window air-conditioning provides cooling to 25 percent of the buildings built before 1945 but only 10 percent of the buildings built since 1970.

A sample list of retrofit options for a large commercial building with a complex reheat type of mechanical system is shown in table 19.

Compared to the other sample lists this list is a long one. There are a large number of low capital cost retrofits to the mechanical system. The most powerful of these is a conversion from the energy wasteful terminal reheat form of controlling the temperature of a multizone building to the variable air-volume method. (Both of these systems are explained in fig. 23, pp. 70-71.) If this building is still equipped with incandescent lights, conversion of fluorescent lights is the most powerful retrofit of all. It saves expensive electricity both for lighting and for cooling. If the building is already equipped with fluorescent lights, a shift to high-efficiency fluorescent lights is cost effective but not nearly as powerful as the shift from incandescent. For commercial buildings the most effective envelope retrofits are those which improve the energy efficiency of the windows. Hot water retrofits are of low capital cost but are insignificant in impact.

**Table 19.—Large Commercial Building:<sup>a</sup>Sample List of Retrofit Options**

| Retrofit                              | Category   | Total retrofit cost (dollars/ft <sup>2</sup> ) | Total energy savings <sup>b</sup> (thousand Btu/ft <sup>2</sup> ) | Capital cost per annual million Btu saved (dollars) |
|---------------------------------------|------------|--|---|---|
| <b>Low capital cost</b>               |            |  |   |   |
| Roof spray . . . . .                  | Envelope   | 0.04   | 10  | Low ( 4)  |
| Replace burner . . . . .              | Mechanical | 0.05   | 20  | Low ( 2)  |
| Vent damper . . . . .                 | Mechanical | 0.02   | 8   | Low ( 3)  |
| Stack heat reclaim . . . . .          | Mechanical | 0.05   | 28  | Low ( 2)  |
| Boiler turbotators . . . . .          | Mechanical | 0.09   | 9   | Low (10)  |
| Setback thermostats . . . . .         | Mechanical | 0.04   | 9   | Low (10)  |
| Convert reheat to variable            |            |  |   |   |
| air volume . . . . .                  | Mechanical | 0.14   | 45  | Low ( 3)  |
| Hot water flow controls . . . . .     | Hot water  | 0.01   | 1   | Low ( 0.5)  |
| Hot water vent damper. . . . .        | Hot water  | 0.01   | 2   | Low ( 1)  |
| Fluorescent hybrid lamps . . . . .    | Lighting   | 0.76   | 132   | Low ( 6)  |
| High-efficiency fluorescent . . . . . | Lighting   | 0.13   | 10  | Low (13)  |
| <b>Moderate capital cost</b>          |            |  |   |   |
| Weatherstripping . . . . .            | Envelope   | 0.06   | 1   | Moderate (44)                                       |
| Double glazing . . . . .              | Envelope   | 0.65   | 13  | Moderate (48)                                       |
| Window insulation . . . . .           | Envelope   | 0.38   | 11  | Moderate (36)                                       |
| Shading devices . . . . .             | Envelope   | 0.25   | 15  | Moderate (17)                                       |
| Insulate ducts . . . . .              | Mechanical | 0.50   | 15  | Moderate (23)                                       |
| Insulate hot water storage . . . . .  | Hot water  | 0.01   | 1   | Moderate (17)                                       |
| <b>High capital cost</b>              |            |  |   |   |
| Roof insulation . . . . .             | Envelope   | 0.30   | 4   | High (73)   |
| Water-cooled condenser . . . . .      | Mechanical | 0.32   | 4   | High (86)   |
| Task lighting . . . . .               | Lighting   | 0.68   | 13  | High (52)   |

NOTE: Savings should not be added. See app. B for estimates of cumulative savings.  
<sup>a</sup>100,000 ft<sup>2</sup> commercial building with clad walls and a complex reheat central heating and cooling system in the St. Louis climate zone.

<sup>b</sup>Electricity energy savings are multiplied by 246 to reflect the difference between the cost of fuel (oil) at \$7.00 per million Btu and the cost of electricity at \$17.00 per million Btu for electricity at \$0.06/kWh.

SOURCE: Office of Technology Assessment.

Three other sample retrofit lists for other types of commercial buildings—with air systems, with water systems and window air-conditioners, and with decentralized heating and cooling—are shown in appendix A. The retrofit lists for commercial buildings with air or water systems also have large numbers of retrofit options to the mechanical systems although the specific retrofits differ from system to system. For a commercial building with a decentralized system on the other hand, the only cost-effective retrofit to the mechanical system is the moderate cost retrofit of replacing all the window air-conditioners with more efficient models. Improvements to the energy efficiency of windows are more cost effective for commercial buildings with decentralized systems because the electricity saved is so expensive. The lists for all four commercial buildings include the very powerful option of shifting from incandescent to fluorescent

lights (for the relatively few commercial buildings with incandescent lights) as well as less powerful and less cost-effective lighting measures.

OTA did not specifically develop a list of retrofits for the 40 percent of commercial building square footage in small commercial *buildings* (less than 10,000 ft<sup>2</sup>). Based on discussions with energy auditors, OTA concludes that a list of retrofits for such buildings would also stress lighting retrofits and retrofits to the mechanical systems (differing by type of system) but would also include storm windows and roof insulation because such measures are feasible and effective in small buildings. Among smaller commercial buildings, a substantial (but unknown) percentage are wood frame construction, for which wall insulation should be of low or moderate capital cost compared to savings.

## EFFECTIVENESS OF INDIVIDUAL RETROFITS FOR DIFFERENT BUILDING TYPES

From the analysis of the effectiveness of specific retrofits for different building types in four climate zones, there are several general observations about the extent to which some retrofit measures are effective in almost all buildings, some measures are only physically applicable to some building types and not to others, and some measures, while physically applicable to all building types are far more effective for some building types than to others. These observations are discussed in this section.

In the analysis that follows, the costs and measures of *cost effectiveness* are approximate and should be used as *rough guides only to distinguish among measures that are very cost effective and those that are not*. For any given building, detailed analysis of costs, estimated savings, and cost effectiveness of measures may differ substantially from these, based on local conditions, building conditions, and more detailed methods of estimating. Appendix C, at the end of the report, gives a brief description of each retrofit and the caution that must be exer-

cised in estimating its savings potential and cost. The full lists of building types and retrofits analyzed and some of the critical assumptions about structural and mechanical system types are listed in appendix tables 3A through 3O at the end of the chapter. The sources for costs and savings estimates for each retrofit are listed in appendix D. Finally, a full set of assumptions is to be published separately in a working paper as a second volume to this report.

The observations about the relative effectiveness of retrofits for different building types based on the calculations and occasional other studies are summarized below in four sections:

- Retrofits to the building envelope.
- Retrofits to the mechanical systems.
- Retrofits to the domestic hot water system.
- Retrofits to the lighting systems.

### Retrofits to the Building Envelope

**Wall Insulation for All Masonry-Bearing and Clad-Wall Buildings Can Be More Than 10**

**Times as Expensive for the Same Energy Savings as Wall Insulation in Cavity Wall Buildings.**

Cavity wall structures can be retrofitted with blown-in insulation at relatively low cost, and with no materials other than the insulation itself and a small amount of material for patching and replacing interior or exterior wall covering, to cover up the holes through which the insulation is blown in (see fig. 18). Masonry-bearing and clad-wall buildings, by contrast, seldom if ever have any available cavity through which to add insulation. The contractor must either create cavities through the addition of a stud wall inside the existing wall, which can receive blown or batt insulation, or must add rigid insulation outside or inside the wall, and pay the cost of completely new exterior or interior wall covering, with corresponding window and door trim.

The calculations of the costs and savings of wall insulation for a wood framehouse and a masonry wall rowhouse are shown below (see fig. 19). The particular calculations are not strictly applicable to detached masonry houses since both costs of wall insulation and savings would be greater in a building with four exposed walls, but the relative cost effectiveness should be the same. Similar results in calculations of the cost effectiveness of wall insulation for moderate-sized buildings were obtained.

**Roof Insulation is Several Times More Expensive for Buildings With Flat Roofs and No Attics or Crawl Spaces Than It is for Buildings With Pitched Roofs That Enclose Attics.**

Although insulation of approximately the same thermal qualities is added to all building types, the estimates of cost effectiveness vary significantly. The retrofit cost per annual million Btu saved is lowest for the insulation work done in attics beneath pitched roofs because of the ease of accessibility. For the cost estimates described here, it was assumed that the attics were unfinished, either with no floor or, at most, with rough floorboards; access to these is relatively straightforward. Costs increase slightly for single-family homes typical of rowhouses in cities, with flat roofs that still have an accessible crawl space between the roof decking and the ceiling of the room below. Costs are higher for

the other roof types, typical of all multifamily and commercial structures, because there is almost never an available cavity. Therefore, the only practical way to add insulation is to reroof, adding rigid insulation beneath the new layer of roofing material.

A sample of the calculations of the costs of roof insulation are shown below (fig. 20). The costs for insulating the concrete slab roofs include the cost of a new roof. It was assumed that the flat roofs already had a thin slab of roof deck insulation. It was also assumed that the peaked roof attic of the small house was insulated—an assumption that excludes the large share of partially insulated houses in the housing stock (see previous section). If the same insulation were added, for example, to an attic equipped already with 2 inches of somewhat compacted rock wool insulation, it is estimated that savings would be only about **60** percent of those in the uninsulated attic,

**Storm Windows and Double Glazing (Replacing Existing Single Pane Glass With New Double-Glazed Units) are Applicable and Cost Effective for Different Window Types.**

Storm windows can be used with wood or metal frame double-hung windows and cannot be used with commercial or residential casement windows. Double-glazing, on the other hand, costs less than half as much for commercial casement windows (\$6/ft<sup>2</sup> of window area) as it does for double-hung wood frame windows (\$13.50/ft<sup>2</sup> of window area). Storm windows are generally cost-effective retrofits for small single-family and multifamily buildings while double glazing is cost effective for commercial buildings and large clad-wall multifamily buildings.

**Most Window Treatments are Cost Effective in Cold Climates and Prohibitively Expensive in Hot Climates.**

Storm windows, double glazing, and night insulation reduce the thermal transmission of windows and are most effective when there is a big differential between inside and outside temperature, especially in cold climates in the winter. Sunscreens and reflective films (see fig. 21) are designed to block the solar gain through windows. Some types are also designed to reduce thermal transmission in the winter.

**Figure 18.—Adding Wall Insulation to Existing Frame Walls and Existing Masonry Walls**

The illustrations below compare the relatively inexpensive technique for adding wall insulation to a frame building (blown-in insulation) with three different, and relatively expensive, techniques for adding wall insulation to solid masonry walls. Similar techniques would also be required for adding insulation to clad walls.

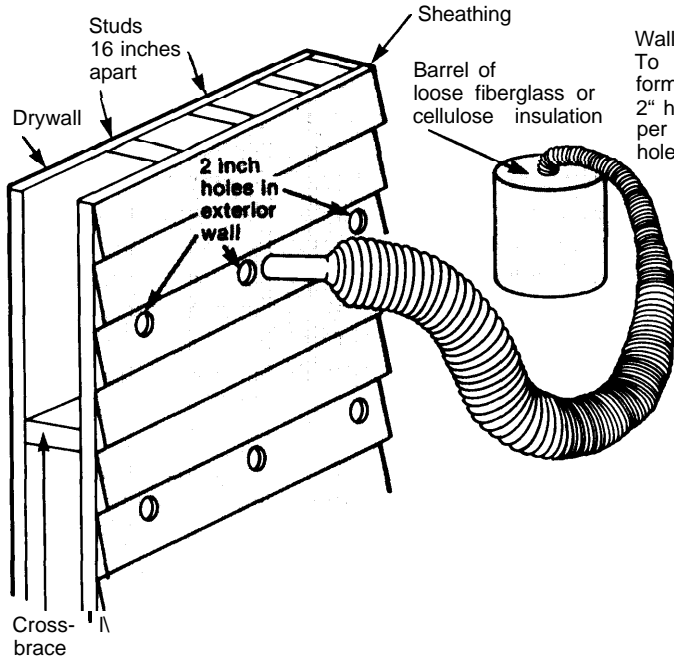

**Wall insulation for frame walls (left)**

To insulate existing frame walls with substantial cavities formed by studs, cross-braces, exterior and interior walls, 2" holes are drilled in each cavity (approximately 2 per stud per floor) and loose fiberglass or cellulose fill is blown. The holes are then plugged with wooden plugs.

**Wall insulation for masonry walls (below)**

There are three ways to add insulation to masonry walls, all of which are expensive. The first way (shown at left) is to add 2 inches of rigid insulation (usually a polystyrene compound with insulation value of R10 to R14) to the outside of the wall and cover it with some acceptable exterior wall finish such as a cement compound with a stucco-like appearance. The second way (middle illustration) is to add 2 inches of rigid insulation on the inside and cover it with drywall. The third way (shown at the right) is to construct an interior wall with 3-5 inch cavities into which batt or loose fill insulation can be placed.

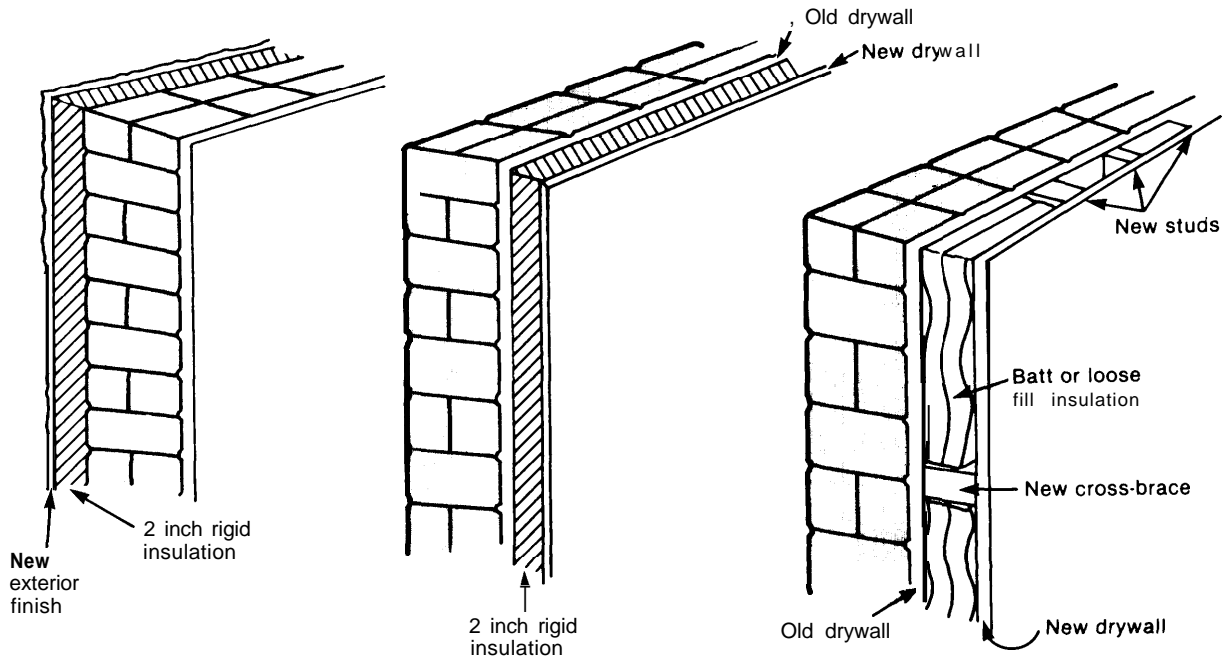

**Figure 19.—Calculated Costs and Savings:<sup>b</sup>  
Wall Insulation**

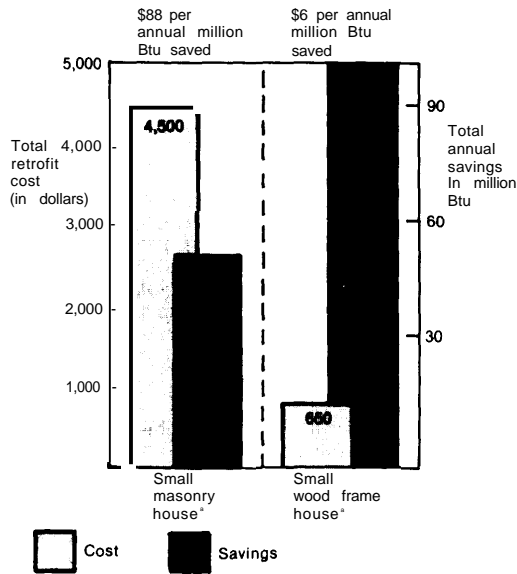

<sup>a</sup>Small houses with water systems in St. Louis climate  
<sup>b</sup>All electricity energy savings have been multiplied by 246 to reflect the difference between the cost of fuel (011) at \$7.00 per million Btu and the cost of electricity at \$1700 per million Btu or electricity at \$0.06/kWh

SOURCE: Office of Technology Assessment. Detailed sources for retrofits in app. G.

The calculations of the cost effectiveness of various window treatments for multifamily and commercial buildings in Buffalo and Tampa are shown in table 20. The particular models of shading device and reflective film analyzed were only applicable to commercial buildings and did block thermal transmission as well as reduce solar gain. The shading device analyzed is a fiberglass screen that acts as a storm window on the window (see fig. 21). It is installed on all windows in the summer and on all windows except those on the south in the winter, and is more cost effective in Buffalo than Tampa. Shading devices that only reduce solar gain were not analyzed, but are likely to be less cost effective in Buffalo than Tampa. Similarly the particular reflective films analyzed are more cost effective in cold climates than hot because they are designed to block thermal transmission as well as solar gain.

**For All Active and Passive Solar Retrofits to All Types of Buildings There are Retrofits to the Building Envelope With Comparable Savings at**

**Figure 20.—Calculated Costs and Savings:  
Roof Insulation**

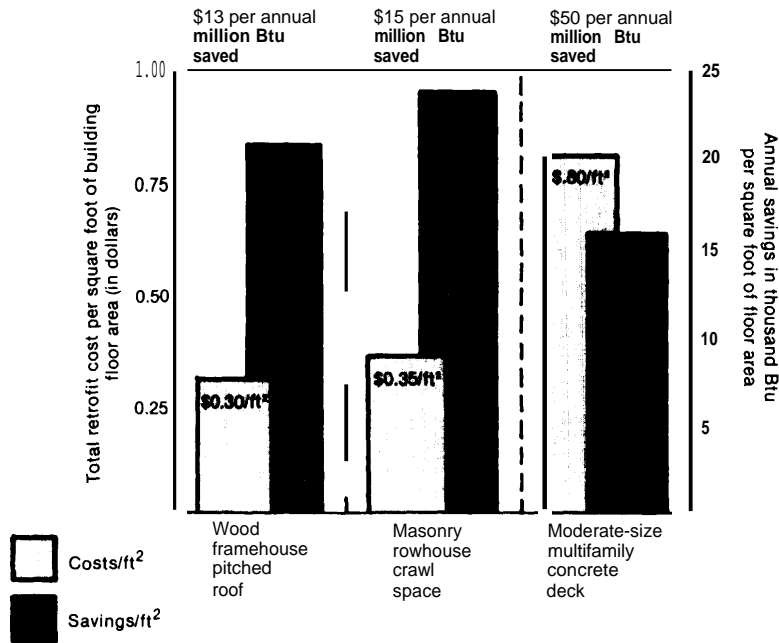

NOTE: Buildings with water systems. St. Louis climate

SOURCE: See app. G.

Figure 21.—Three Window Retrofits

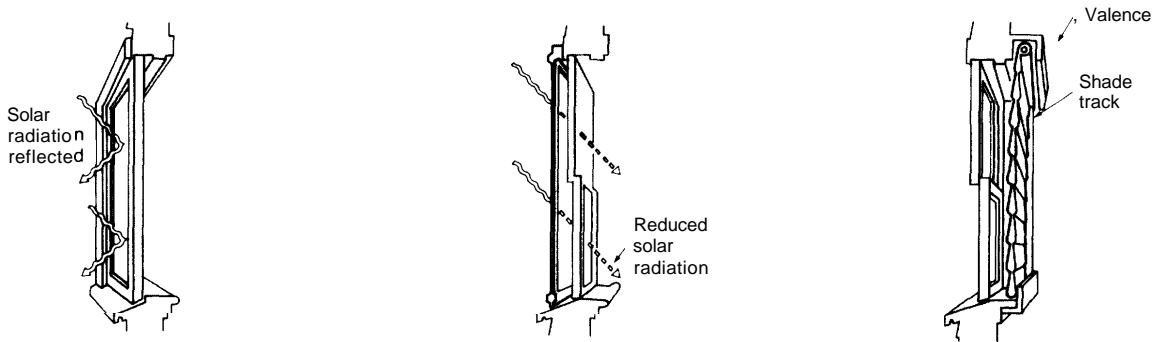

**Reflecting film**

Semitransparent plastic film with a very thin reflective layer reflects solar radiation out to reduce cooling requirements and also reflects thermal radiation back into the room to reduce heating requirements.

SOURCE: Office of Technology Assessment.

**Sunscreen**

A solid sheet of tinted fiberglass is fitted outside, reducing conductive heat loss in winter and solar gain in summer.

**Thermal shade**

Quilted, polyester fiber-fill lined window shade with a track or magnetic fastening system to maintain a good air seal between the shade and the window.

Table 20.—Calculated Capital Cost of Window Retrofits in Buffalo and Tampa (approximate investment cost per annual million Btu saved is shown in parentheses)<sup>c</sup>

|  | Buffalo         | Tampa                      |
|--|-----------------|----------------------------|
| <b>Retrofits for a moderate-sized multifamily building<sup>a</sup></b> |                 |                            |
| Weatherstripping   | Moderate (\$20) | High (\$60)                |
| Storm windows  | Moderate (\$20) | High (\$75)                |
| Window insulation  | Moderate (\$35) | Not cost effective (\$300) |
| Double glazing   | High (\$70)     | Not cost effective (\$140) |
| <b>Retrofits for a moderate-sized commercial building<sup>b</sup></b>  |                 |                            |
| Shading device (see illustration)                                      | Moderate (\$15) | Moderate (\$20)            |
| Reflective film (designed to also block thermal transmission)          | Moderate (\$25) | High (\$40)                |
| Double glazing   | Moderate (\$40) | High (\$60)                |

<sup>a</sup> 15,000 ft<sup>2</sup> masonry building with air system

<sup>b</sup> 15,000 ft<sup>2</sup> clad wall building with air systems

<sup>c</sup> All electricity savings have been multiplied by 2.46 to reflect the greater expense of electricity

SOURCE: Office of Technology Assessment.

**the Same or Less Cost.** Passive solar retrofits are retrofits designed to use the heat of the Sun (solar gain) through windows or glazed walls to provide heat to a building. By definition they are systems that have no moving parts and as such are simpler and usually less expensive than active solar systems (which must use pumps or fans to transfer heat from liquids or air heated by the Sun—see fig. 22).<sup>5</sup> OTA did some simple

<sup>5</sup>For further discussion of active and passive solar systems see two previous OTA studies: *Application of Solar Technology to Today's Energy Needs*, vol. 1, OTA-E-66, June 1978; *Residential Energy Conservation*, vol. I, OTA-E-92, July 1979.

calculations to compare the cost effectiveness of several passive solar and active solar retrofit measures with the cost effectiveness of wall insulation, roof insulation, and various conservation retrofit measures for windows. The results (shown in table 21) are only suggestive, but they are consistent with several other studies.

For a wood frame single-family house, under OTA's assumptions, wall insulation is by far the most cost-effective retrofit and has much lower capital cost than any solar retrofits. Two passive solar retrofits, however, are of moderate capital cost and comparable to roof insulation or storm windows for such a house. One of these retrofits is very simple. It would add 100 ft<sup>2</sup> of glazing on the south side of the house and provide insulation for this area at night. In a variation of this retrofit, glazing would also be added but water wall storage would be used behind part of it to store the heat to provide heat at night.<sup>6</sup>

For a masonry wall rowhouse, adding glazing (with insulation) is far less expensive than wall insulation and comparable to roof insulation and storm windows. It is also substantially less expensive for the savings than another passive solar retrofit considered suitable to masonry buildings—the Trombe Wall (see fig. 22). For this retrofit, the wall is painted black and

<sup>6</sup>OTA's calculations did not include the cost of savings for night insulation in addition to the storage. Night insulation would increase both the cost and savings with an indeterminate impact on cost effectiveness.

**Figure 22.—One Active and Two Passive Solar Devices for Heating Buildings**

The illustrations below show two passive solar devices for providing space heat to buildings—a *thermosiphoning air panel* and a *Trombe wall*. Also shown is an *active solar collector* which provides both hot water and space heat.

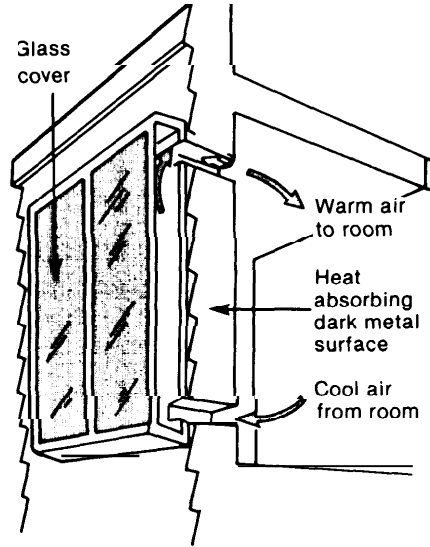
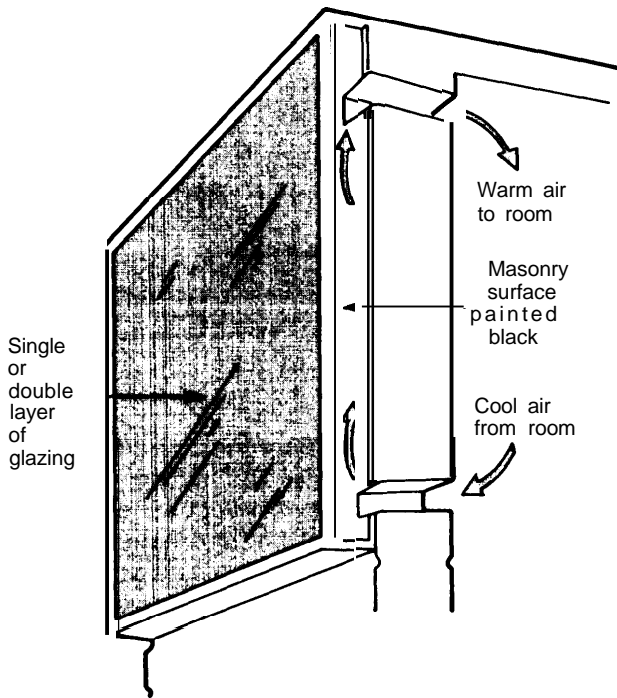

**Thermosiphoning air panel (above)**

Where masonry walls do not exist, metal panels painted black and covered with glazing can be attached to the south wall. As for the Trombe wall, there are thermocirculation vents at the top and the bottom of the panel.

**Trombe wall (above)**

For this retrofit, a south-facing masonry wall is painted a dark color and covered with glazing to minimize heat loss. Thermocirculation vents at the top and bottom provide a flow of air that draws hot air into the room at the top and draws cold air out of the room at the bottom. Dampers are closed at night to prevent backdraft losses.

**Active solar space and domestic hot water heater**

Flat plate collectors are installed in the roof. The solar-heated liquid circulates through a heat exchanger in a central tank of hot water. This water in turn runs through a heat exchanger into the domestic hot water tank and through another heat exchanger into an air handling unit for space heat.

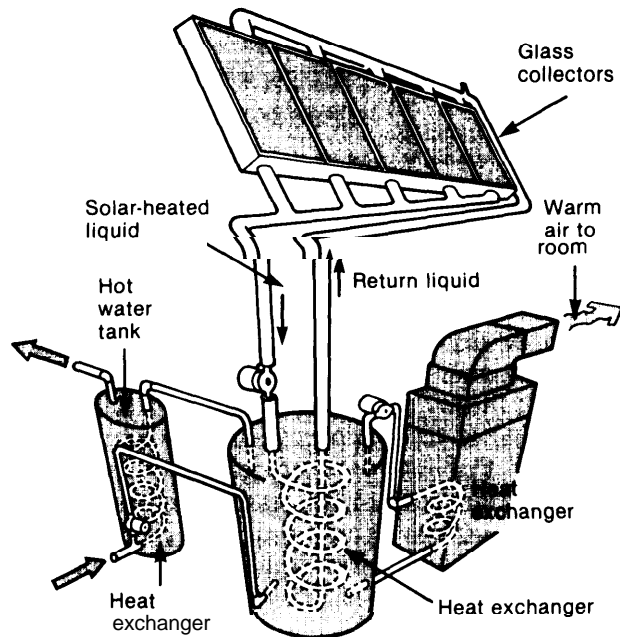

**Table 21.—Calculated Capital Costs of Energy Efficiency Retrofits Compared to Active and Passive Solar Retrofits**

|  | Estimated total annual energy savings <sup>a</sup> |                | Capital cost category (dollars per annual million Btu of savings) |                          |
|--|--|----------------|---|--------------------------|
|  | Energy efficiency retrofit                         | Solar retrofit | Energy efficiency retrofit  | Solar retrofit           |
|  | (million Btu)                                      |                |   |                          |
| <b>Small wood framehouse<sup>b</sup></b>                           |  |                |   |                          |
| Roof insulation . . . . .  | 42   |                | Moderate (15)   |                          |
| Wall insulation . . . . .  | 108  |                | Low (6)   |                          |
| Storm windows . . . . .  | 31   |                | Moderate (30)   |                          |
| Add 100 ft <sup>2</sup> of glazing with night insulation . . . . . |  | 30             |   | Moderate (20)            |
| Add glazing with thermal storage . . . . .                         |  | 35             |   | Moderate (40)            |
| Add thermosiphoning wall panel . . . . .                           |  | 17             |   | Not cost effective (120) |
| <b>Moderate masonry rowhouse<sup>b</sup></b>                       |  |                |   |                          |
| Roof insulation . . . . .  | 47   |                | Moderate (15)   |                          |
| Wall insulation . . . . .  | 53   |                | High (1 10)   |                          |
| Add glazing with night insulation . . . . .                        |  | 30             |   | Moderate (20)            |
| Glaze masonry wall (Trombe wall) . . . . .                         |  | 43             |   | High (65)                |
| <b>Large masonry multifamily building<sup>b</sup></b>              |  |                |   |                          |
| Roof insulation . . . . .  | 637  |                | High (50)   |                          |
| Night insulation on all windows . . . . .                          | 631  |                | Moderate (40)   |                          |
| Flat plate collectors for space heat and hot water . . . . .       |  | 1,480          |   | High (80)                |
| Add glazing with thermal storage . . . . .                         |  | 480            |   | High (70)                |
| Add glazing with night insulation . . . . .                        |  | 520            |   | Moderate (30)            |

NOTE: Savings should not be added. For detailed sources see app. D.

<sup>a</sup>All savings of electricity have been multiplied by 2.46 to reflect the greater expense of electricity.

<sup>b</sup>2,000 ft<sup>2</sup>, 15,000 ft<sup>2</sup>, and 100,000 ft<sup>2</sup> buildings with water systems in the St. Louis climate zone.

SOURCE: Office of Technology Assessment

glazed. Ventilation openings cut in the wall allow heated air to rise in the space between metal panel and glazing and flow into the room. By OTA's calculations, this retrofit is of **high** capital cost for the savings.

For a large multifamily building, roof insulation is high capital cost (compared to savings) and wall insulation is not cost effective at all. The calculated high capital cost of an active flat plate system for providing space heat and hot water (see fig. 22) is at least comparable to these measures. The only envelope retrofits of moderate capital cost are adding night insulation on all windows (conservation retrofit) or adding glazing on the south side equipped with night insulation (passive solar retrofit). As was pointed

out in the preceding section, however, retrofits to the building envelope in general are less cost effective for large multifamily buildings than are retrofits to the domestic hot water system and to the mechanical system.

The results are consistent with the results of several other studies of solar retrofits and solar features in cities. A careful architectural analysis of the optimum balance of insulation, passive and active solar features for rehabilitated and retrofitted buildings in the low-income Manchester neighborhood of Pittsburgh came to a preliminary conclusion that the best combination is likely to be either thorough insulation and blocking of infiltration alone or a combina-



tion of thorough insulation and large windows on the south side for increased solar gain. <sup>7</sup>

An analysis of low-cost solar options in the Boston area concluded that many passive solar retrofits (such as solar porches, sunspaces and greenhouses, wall collectors, thermosiphoning wall panels—see fig. 22—and night insulation applied to increased window size) are only competitive with the costs of conventional fuels if labor is contributed free or at reduced cost, if the retrofit cost is amortized over the life of the measure and if a tax credit or other subsidy is provided. These are very stringent criteria in light of the impact of financing difficulties and high interest rates described in chapter 4. Of all the measures analyzed, only homemade insulating shades provide a payback that would categorize the measure as of moderate capital cost. <sup>8</sup>

For climates that are more favorable than those of Boston, the cost effectiveness of passive solar retrofits appears greater although very variable. In a survey by the Tennessee Valley Authority (TVA) of costs and savings of passive solar retrofits, the retrofit cost per annual million Btu saved ranges from \$14 per annual million Btu saved to \$140 for a Trombe Wall, from \$28 to \$190 for south windows, and from \$27 to \$360 for a solar greenhouse. <sup>9</sup>

### Retrofits to the Mechanical System

For many building types, especially larger building types, retrofits to the mechanical system are likely to be the most effective of all retrofits, although specific retrofits and their relative cost effectiveness differ substantially among the four mechanical systems analyzed for this report. OTA developed lists of retrofits for each mechanical system type for each size

and use of building. In a few cases the precise list of retrofits is more applicable to the specific system modeled than it is to other systems of the same general type. Appendix table D to this chapter describes the basic mechanical systems modeled for each type and identifies the most important differences in the lists of retrofits for other systems of the same type. The general conclusions from the analysis are described below.

#### **The Most Effective Retrofit to a Building With a Complex Reheat System is to Convert the Reheat System to a Variable Air Volume System.** (See fig. 23 for diagrams of a terminal reheat system, variable air volume system, and three other mechanical systems suitable for large commercial buildings with several zones.)

Complex systems with terminal reheat features are extremely wasteful; their name derives from the fact that they operate by centrally cooling all air to be used in the building to a single temperature, typically around 55° F. This chilled air is then distributed to the various zones of the building through ducts, and just before being introduced into the conditioned space, the air is reheated to the desired temperature. Used almost solely in commercial buildings, a terminal reheat system provides very precise temperature control. In addition, it neatly handles the conditioning problem that occurs in commercial buildings with large "core" areas, i.e., interior areas of the building, where, because of the amount of heat generated by people, lights, and office equipment, air-conditioning is required year round. On a cold day in January, in this type of building, a terminal reheat system can send cooled air without reheat to the core areas of the building, and send cooled air which is then reheated at the perimeter areas near the windows, where relatively heated air is needed. This type of system uses energy twice to achieve a single desired temperature; first using energy to cool, then to heat air. As a result, the total heating load of commercial buildings with complex systems is more than twice that of comparable buildings with air or water systems. Reheat mechanical systems can generally be converted to variable air volume systems, a type of air system, with little difficulty. Variable air volume

<sup>7</sup>*Energy Guidelines for an Inner-City Neighborhood*, Travis O. Price III & Partners and VolkerHartkoff, Naomi Yoran, and Lawrence Hoffman of Carnegie Mellon University. *Proceedings of the Fifth National Passive Solar Conference*. Published by the American Section of the International Solar Energy Society, Inc., a workbook based on this analysis is due to be published in 1981.

<sup>8</sup>*Boston Solar Retrofits: Studies of Solar Access and Economics*. Michael Shapiro (with Shauna Doyle), Kennedy School of Government, December 1980.

<sup>9</sup>*Building a Sustainable Future*, vol. 2, SE RI, published by the House Committee on Energy and Commerce, April 1981, p. 171.

systems supply air at constant temperatures for each set of hot air and cool air requirements and satisfies the needs for different zones by varying the volume of air supplied. Such systems require central air-handling controls which are usually already installed for reheat systems. Installing such controls is estimated to add about 30 percent to the cost. Some temperature control is sacrificed, but the savings are so great that they equal the cost of the retrofit very quickly. In the particular calculation done for a building of 100,000 ft<sup>2</sup>, the retrofit would cost about \$0.14 ft<sup>2</sup> (\$14,000 total) and save about 45,000 Btu/ft<sup>2</sup> which would be worth about \$0.32 ft<sup>2</sup> for heating oil at \$1 /gal. The savings in this case would equal the cost of the retrofit in less than a year (see table 19).

**Lists of Retrofits are Different for Air Systems and Water Systems But They Perform Similar Functions.** Some retrofits to improve the efficiency of air (including reheat systems converted to variable air volume systems) and water mechanical systems are described in figures 24 and 25. The calculations of costs and savings for some of them are shown in table 22. Some retrofits improve the combustion efficiency of the central heat source: replacing the burner for both air and water systems (see fig. 25 for a description of the source of improved efficiency), replacing the *entire boiler* for a water-based system or replacing the furnace for an air system. [In the particular set of calculations shown in table 22, it was assumed that an old boiler of slightly over 50-percent combustion efficiency (the ratio of Btu of usable heat to Btu of fuel) was replaced by a new boiler of almost 75-percent combustion efficiency. The costs of a new boiler are estimated to be large but savings are great enough that it falls into the category of moderate capital cost compared to savings.

*Vent dampers* improve the efficiency of both water and air systems by preventing heat from escaping up the flue when the burner is not firing. An electrically activated damper automatically closes when the burner is cycled off. A stack heat *reclaimer* is a device for water systems that uses the heat that escapes up the stack from a boiler to preheat the water that

passes through the boiler. A *boiler* turbolator reduces stack heat losses before heat goes up the stack by improving the exchange of heat between the hot combustion gases and the water to be heated.

Several devices improve efficiency by taking better advantage of variations in outside temperature with the change of seasons. For water systems, a *modulating aquastat* regulates the temperature of the water in the boiler according to the outdoor temperature. On very cold days, the boiler temperature is allowed to rise. On milder days, it is kept lower. For air systems with central air-conditioning a similar retrofit varies the temperature of chilled water according to the outside temperature, setting it coldest on the hottest days. Also for air systems a *two-speed fan motor* sets the fan to blow faster for the peak cooling load and slower for the heating load which usually requires a smaller air volume. An *economizer damper control*, also for air systems, makes possible the automatic use of outside air for cooling when outside air is cooler than that inside. Most of these retrofits are low or moderate capital cost compared to savings.

**Many Retrofits to Mechanical Systems Benefit From Economies of Scale and Cost Significantly Less per Annual Million Btu Saved in Large Buildings Than in Small Ones.** The cost of many retrofits to mechanical systems is only somewhat greater for large buildings than small, but the savings can be many times greater. This point can be illustrated with the calculations of the costs and savings for a modulating aquastat (the device that increases boiler water temperature when the outside air is colder, and vice versa). As shown in figure 26, the cost of the modulating aquastat for a 100,000 ft<sup>2</sup> multifamily building is about double the cost of one for a small 2,000 ft<sup>2</sup> rowhouse, but the savings are 40 times as great. Figure 27 illustrates the same phenomenon for four other retrofits to mechanical systems. Replacing a boiler, for example, at \$50 per annual million Btu saved would be a high capital cost retrofit for a small rowhouse in Buffalo, but is a low capital cost retrofit (at \$12 per annual million Btu saved) for a large multifamily building.

**Figure 23.—Five Systems for Adjusting the Amount of Heat and Cooling to Different Zones in a Commercial Building**

The illustrations below and next page show five different heating and cooling systems designed to handle the complex requirements of large commercial buildings. In such buildings, core areas and machine rooms with high heat loads require less heat and more cooling than peripheral areas of the building. An effective but energy-inefficient way to handle these mixed requirements is using any of a number of systems with reheat features: *terminal reheat* or *multizone* or *variable air volume* which may or may not include reheat. In reheat systems the air may be cooled below the temperature needed and then reheated for purposes of dehumidification as well as zone control. A *variable air volume* system with no reheat feature is far more energy efficient than any of the systems with reheat. *Induction* and *fan-coil* systems also eliminate simultaneous heating and cooling. In OTA's classification, terminal reheat and multizone are classified as *water systems*. (See app. table 3D for a more comprehensive list of systems in each type.) Retrofits which are appropriate to such systems are generally determined by their general type.

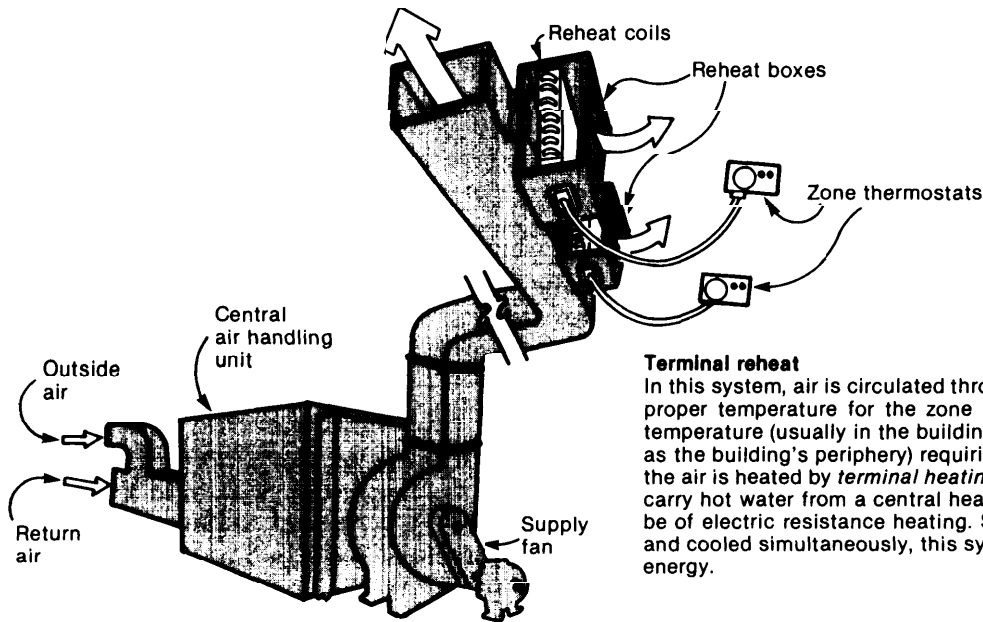

**Multizone**

This system requires separate air ducts for each zone. The proper air temperature for each zone is mixed in a central mechanical room by varying the amount of air coming from a *hot deck* or a *cold deck* as dictated by *zone thermostats*. A *master thermostat* controls the temperatures of the hot decks and the cold decks.

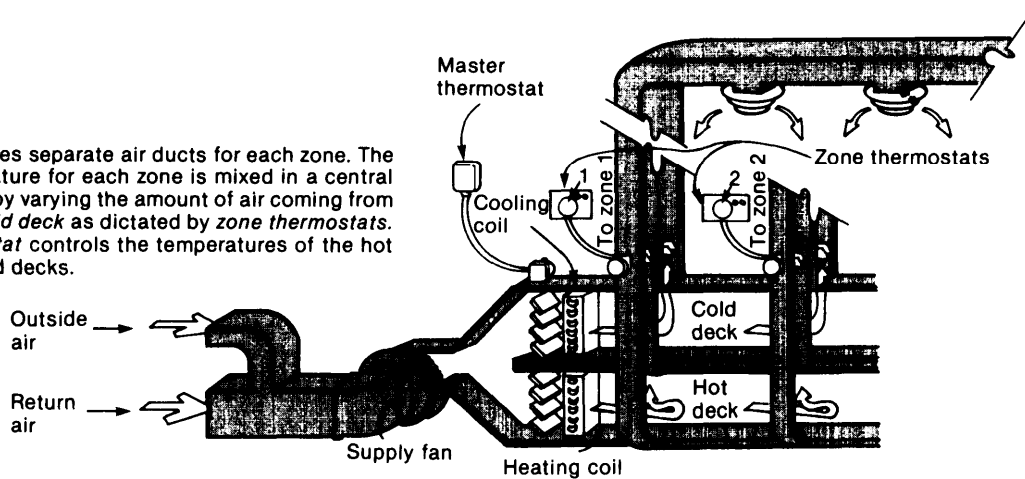

SOURCE: Office of Technology Assessment.

Figure 23.—Five Systems for Adjusting the Amount of Heat and Cooling to Different Zones in a Commercial Building (Continued)

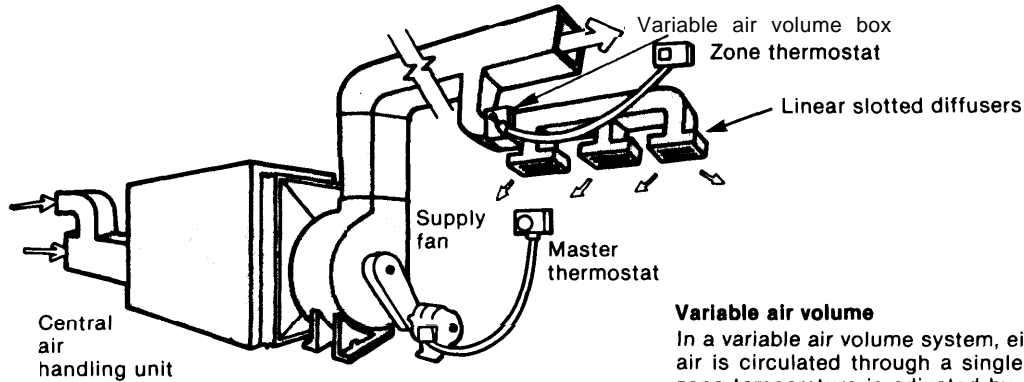

**Variable air volume**

In a variable air volume system, either heated air or cooled air is circulated through a single duct to each zone. The zone temperature is adjusted by adjusting the size of the orifice in the variable air volume box. Terminal reheat systems can usually be converted to variable air volume systems for low to moderate capital cost compared to savings.

**Induction system**

This system uses both water and air to provide heat to different zones in a commercial building. For heat, hot water is circulated through pipes from a boiler to auxiliary heating cooling coils inside induction units in each zone. These units are also supplied with heated or cooled air from a central air handling unit. The air is ejected at high speed from nozzles within each unit, inducing room air to be drawn across the heating coil. For cooling, cold water from a chiller is circulated to the induction units.

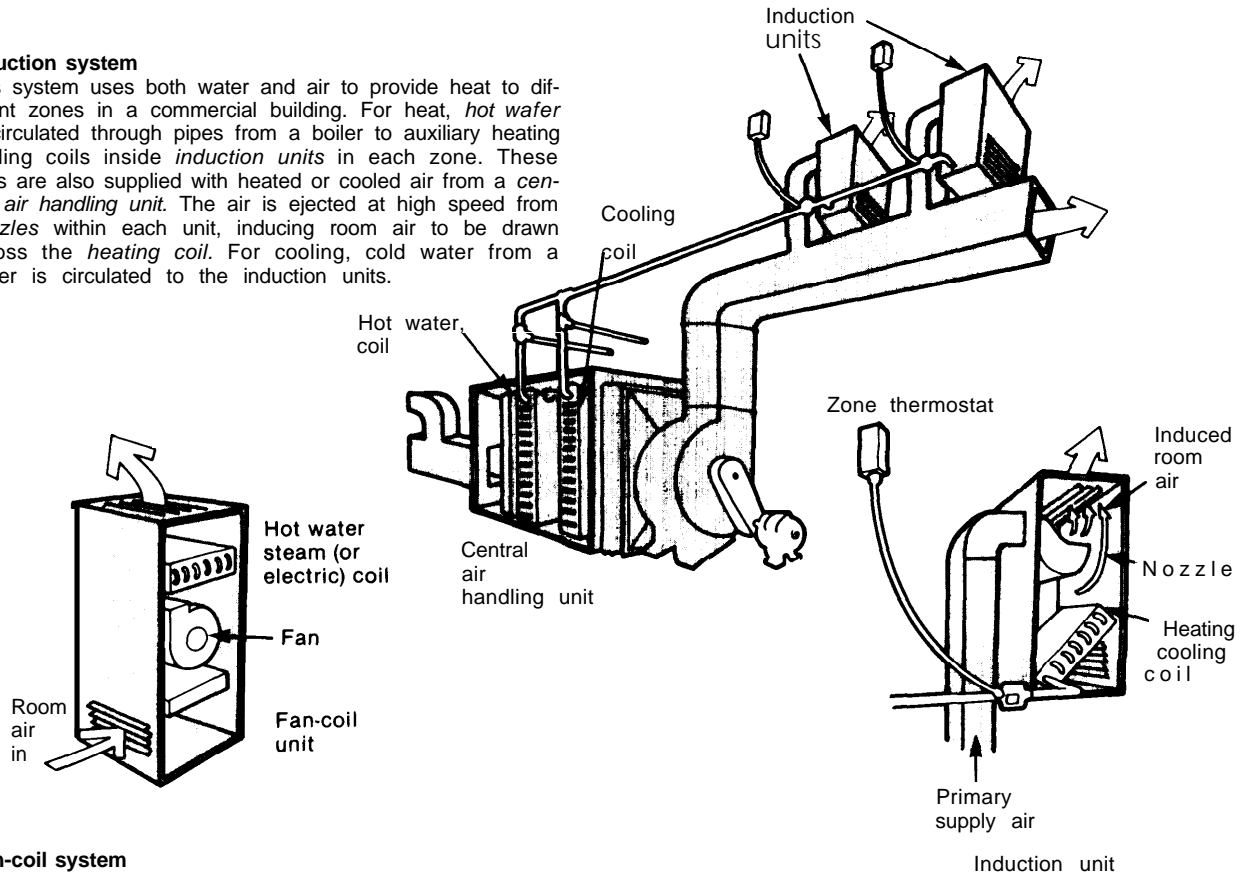

**Fan-coil system**

In a fan-coil system, the hot or cool water is circulated from a central source to the coils in a fan-coil unit in each zone. Within each unit, a fan propels air over the hot coil (for heat) and out into the room while cooler air from the room is drawn into the fan coil unit to be warmed. For cooling, air from the room is cooled by a similar process.

SOURCE: Office of Technology Assessment

**Figure 24.—Sample Retrofits to Central Air Heating and Cooling Systems**

The illustration below shows a single-zone air heating and cooling system and several of the retrofits that might be applicable to such a system.

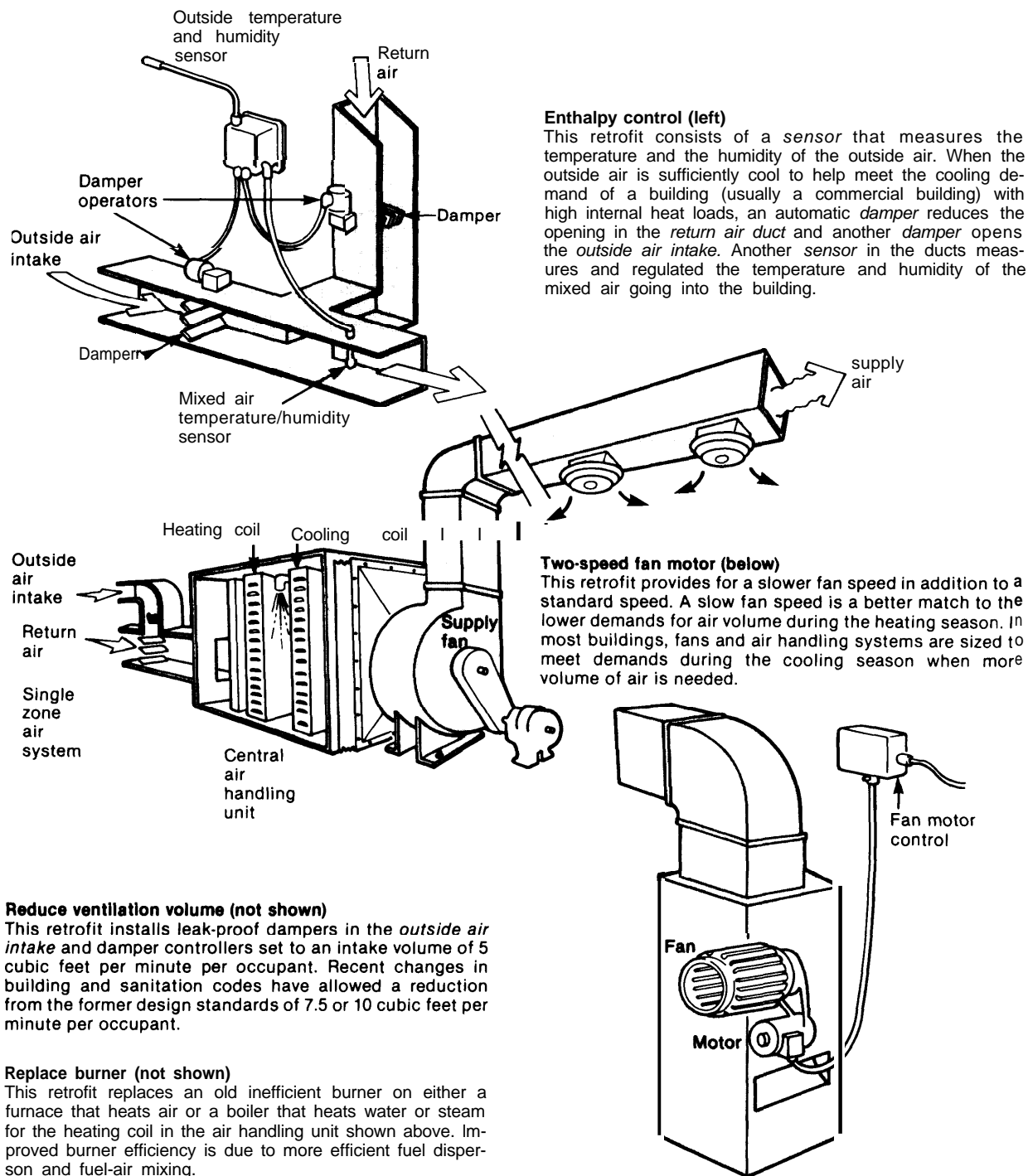

SOURCE: Office of Technology Assessment.

**Figure 25.—Sample Retrofits to Water-Based Heating Systems**

The illustrations below show five different retrofits appropriate to water systems. All three heating sources shown are boilers.

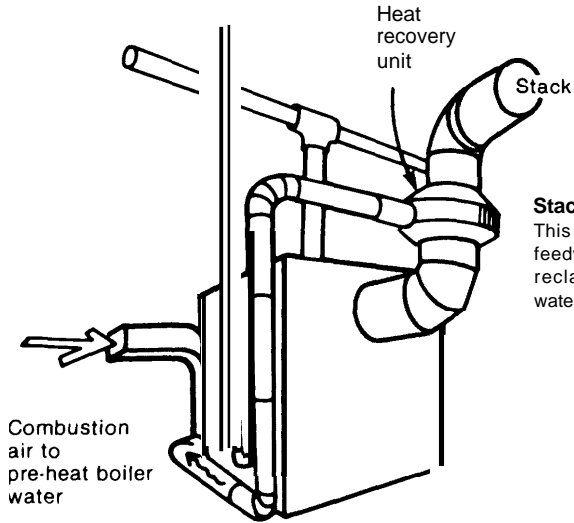

Vent damper (not shown)  
An electronically-controlled vent damper closes the stack when the burner is not firing in order to reduce the loss of heat up the stack.

**Stack heat reclaimer (left)**

This device recaptures heat by circulating water (for boiler feedwater) or air (for combustion air) through the stack heat reclaimer, thus transferring heat from the flue gas to the water or air.

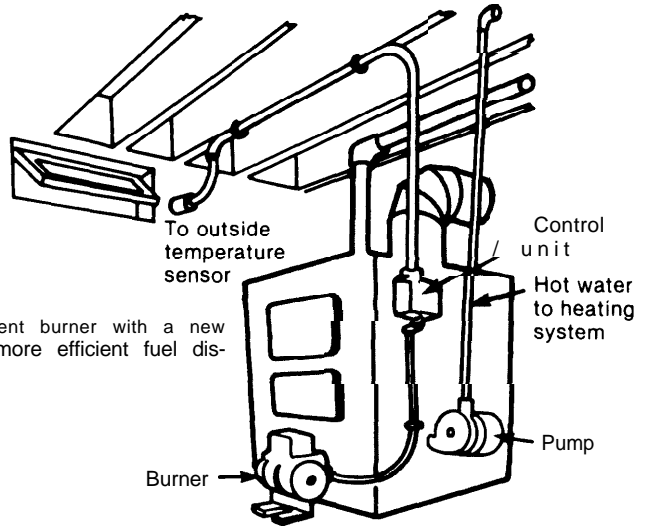

**Replace burner**

This retrofit replaces an old inefficient burner with a new burner of greater efficiency due to more efficient fuel dispersion, and fuel-air mixing,

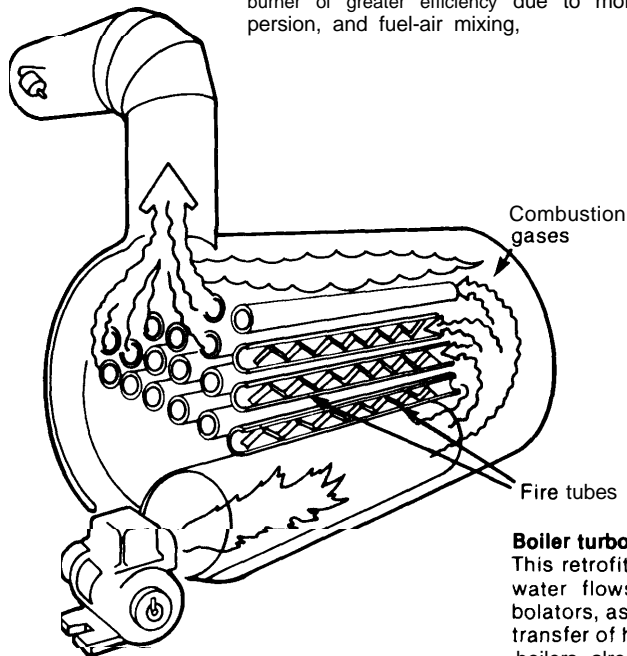

**Modulating aquastat (above)**

This device consists of an outside temperature sensor and a control system that automatically resets boiler water temperature to match the outside temperature: hotter water for colder outside temperatures and vice versa.

**Boiler turbolators**

This retrofit only applies to fire tube boilers (in which the water flows around tubes filled with hot gases). Turbolators, as shown, slow the gases down and improve the transfer of heat between hot gas and water. Many fire-tube boilers already have turbolators.

SOURCE: Off Ice of Technology Assessment

**Table 22.—Calculated Capital Costs of Retrofits to Air and Water Mechanical Systems**

| Retrofit  | Total cost per installation | Relative capital cost (number in parentheses is retrofit cost per annual million Btu saved) |
|---|-----------------------------|---|
| Applicable to both air and water systems                            |                             |   |
| —Vent damper . . . . .  | \$1,300                     | Low ( <b>\$7</b> )  |
| —Replace burner . . . . .   | 2,900                       | Moderate ( <b>\$35</b> )  |
| Applicable to air <b>systems only</b>                               |                             |   |
| —Economizer damper control (to use temperate outside air) . . . . . | <b>2,000</b>                | Low ( <b>\$2</b> )  |
| —2 speed fan motor . . . . .  | <b>500</b>                  | Low ( <b>\$4</b> )  |
| —Vary temperature of chilled water. . . . .                         | 2,200                       | Moderate ( <b>\$24</b> )  |
| —Replace furnace . . . . .  | (Not estimated)             |   |
| Applicable to water systems only                                    |                             |   |
| —Stack heat reclaim (to pre-heat boiler water) . . . . .            | <b>1,200</b>                | Low ( <b>\$12</b> )   |
| —Modulating aquastat . . . . .                                      | <b>400</b>                  | Low ( <b>\$5</b> )  |
| —Replace boiler . . . . .   | <b>4,500</b>                | Moderate ( <b>\$35</b> )  |
| —Boiler turbolator . . . . .  | 1,800                       | High ( <b>\$90</b> )  |

**NOTES: Calculations** were done for a hypothetical 15,000 ft<sup>2</sup> multifamily building in St. Louis. See app. C for a description of each measure and app. D for sources on costs and savings.

**SOURCE:** Office of Technology Assessment.

**Figure 26.—Calculated Capital Costs of a Modulating Aquastat—Three Building Sizes**

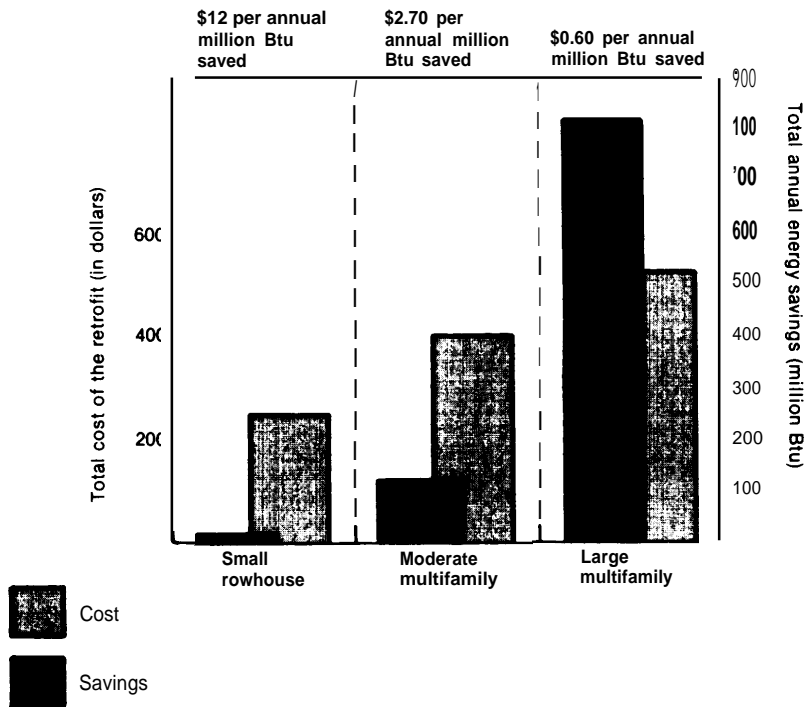

**SOURCE:** Office of Technology Assessment, See app. D for detailed sources on retrofits.

**Figure 27.—Calculated Capital Costs of Four Mechanical System Retrofits—Three Building Sizes**

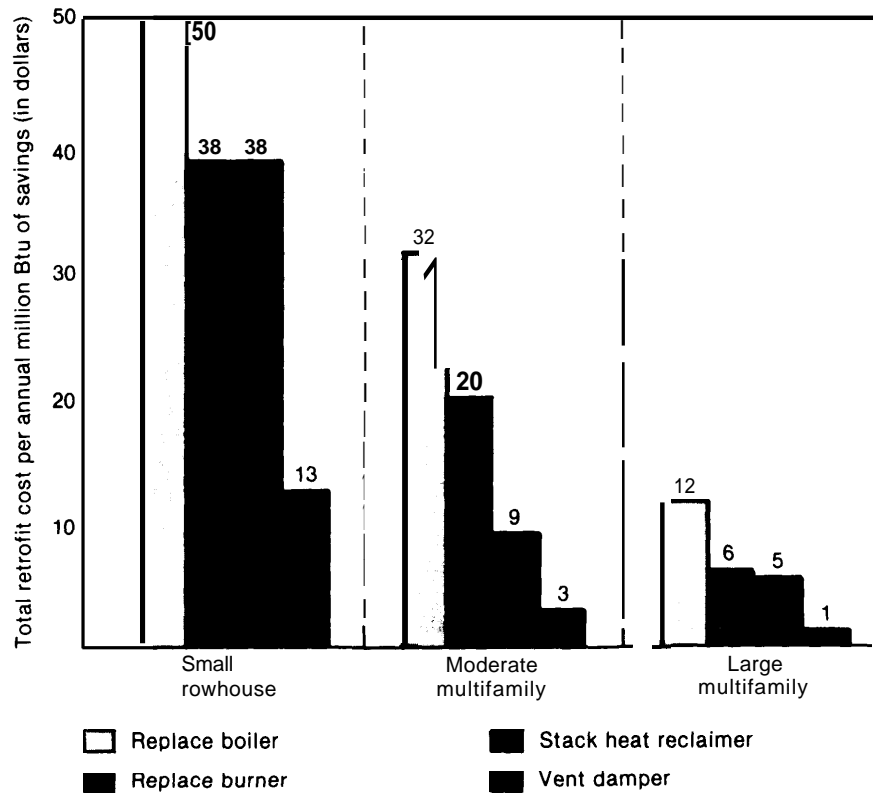

NOTE: Buildings of 2,000 ft<sup>2</sup>, 15,000 ft<sup>2</sup>, and 100,000 ft<sup>2</sup> with water systems in Buffalo climate.

SOURCE Office of Technology Assessment See app D for detailed sources for individual retrofits

**The Installation of Setback Thermostats is Very Cost Effective, If Used Properly, in All Building Types and All Climate Zones Except the Very Warmest.** This retrofit measure, by now well-known and well-documented, is adaptable both to small family homes and large commercial buildings. At its simplest, it reduces the temperature of specific rooms or zones overnight or when unoccupied. Timers lower the temperature automatically and may be set to raise it again before the room or zone will be occupied in the morning. The savings estimated for this analysis assume that the daytime temperature is 65° and nighttime temperature is 55°, and that the daytime temperature was maintained around the clock before the setback thermostat was installed. There will be no savings, except in labor costs, if maintenance crews already performed the setback function manually.

Setback thermostats can also reduce cooling loads, but it was assumed for this analysis that the cooling load is already kept to a minimum by maintaining the daytime temperature at 78° and turning off the cooling system in commercial buildings at night. OTA did not analyze the substantial benefits of more complex energy management systems that are being successfully installed in many commercial buildings. Such systems, using central or microcomputers, can manage lighting systems, ventilation, and the temperature of circulating water as well as space thermostat settings.

The estimates of the retrofit cost per annual million Btu saved range from low (\$5) for setback thermostats installed in a large multifamily building in Buffalo, to moderate (\$25) for the same building in Tampa.



**For Buildings With Decentralized Systems, There are Few Cost Effective Retrofits to the Mechanical Systems. Decentralized systems heat and cool with individual air-conditioners, individual gas heaters, or occasionally with individual heat pumps. By definition, there are no ducts or pipes, nor is there** complex interaction among ventilation, heating, and cooling. Efficiency improvements cannot be achieved by modifications to a single central plant. In most cases, efficiency can only be improved by replacing all less efficient individual units with more efficient individual units.

Under some circumstances, savings can be considerable by replacing *all air-conditioners in a building with more efficient air-conditioners*. The calculations of the costs and savings from such a retrofit are shown in figure 28. For both a

small framehouse and a large multifamily building, it is assumed that room air-conditioners with a seasonal efficiency of 1.5 (coefficient of performance—the ratios of Btu of cooling to Btu of input electricity) were replaced with new air-conditioners with a seasonal efficiency of 2.3. Savings are greatest in hot climates and thus the retrofit has a much lower capital cost (per annual million Btu saved) in Tampa than it does in Buffalo. It is assumed that the cost of each unit air-conditioner is the same for large buildings as for small and that the cooling load per square foot is somewhat lower. So under these assumptions, replacing the air-conditioners has a higher capital cost in a larger building than in a small one. If a discount were available for a bulk purchase of new air-conditioners for a large building, however, this retrofit might be equally cost effective in large buildings,

**Figure 28.—Calculated Capital Cost of Replacing Window Air-Conditioners in Tampa, St. Louis, and Buffalo**

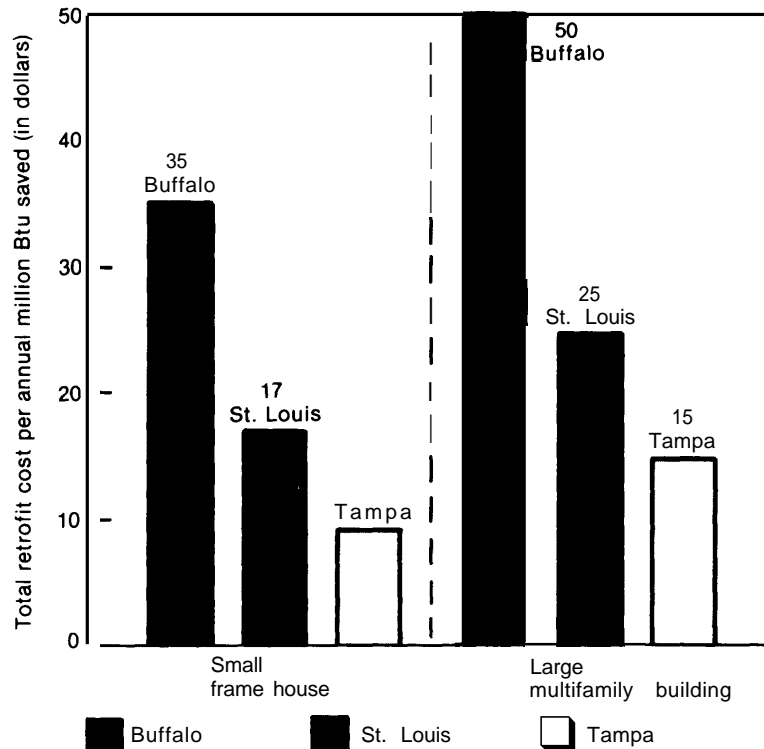

NOTES: The original ratios of cost to savings in end-use Btu are multiplied by 0.4 to reflect the difference between the cost of fuel (oil) at \$7.00 per million Btu and the cost of electricity at \$1700 per million Btu (equals \$0.06 per kWh).

SOURCE: Off Ice of Technology Assessment.

OTA also estimated costs and savings for replacing both the electric resistance heaters and air-conditioners with heat pumps that perform both heating and cooling. Heat pumps currently on the market tend to be more efficient at heating than electric resistance heaters but less efficient at cooling than conventional window air-conditioners. The calculations reflect this assumption. Installing heat pumps is a retrofit of moderate capital cost, compared to savings, for a large multifamily building in Buffalo, St. Louis and Memphis, but actually uses more energy in Tampa where the cooling load is far more important than the heating load. Newer heat pump technology with higher efficiencies for both heating and air-conditioning should prove to be an effective retrofit in Tampa as well as in colder climates. Further improvements in air-conditioning technology could also increase the cost effectiveness of replacing existing air-conditioners with more efficient ones. "

### Retrofits to the Domestic Hot Water System

**Many Retrofits to Improve Hot Water System Efficiency are Very Cost Effective in All Types of Residential Buildings in All Climates.** The energy used for domestic hot water is a significant fraction of single-family and multifamily energy use and a much smaller fraction of the energy use of most commercial buildings. This can be illustrated with the calculations of the fraction of energy for domestic hot water used for several types of buildings in Buffalo and Tampa.

|                             | Hot water as a percent of total building energy use |
|-----------------------------|---|
| Small framehouse            | 7   |
| Small rowhouse              | 11  |
| Large multifamily building. | 25  |
| Large commercial building.  | 6   |

Furthermore domestic hot water is a bigger fraction of the energy use of all buildings, residen-

<sup>10</sup>OTA's assumptions about relative seasonal efficiencies were as follows:

- a. Heat pump cooling efficiency: 85 percent of conventional window air-conditioner—1.5 instead of 1.8 Instantaneous coefficient of performance (COP) and 1.3 Instead of 1.5 seasonal COP.
- b. Heat pump heat/rig efficiency: Seasonal COP: Buffalo , 1.3; St. Louis 1.55; Memphis 1.8; Tampa 2.15.

tial and commercial, in warmer climates (since a smaller fraction of energy goes for heat).

Several retrofits to the hot water system are very cost effective in all climates and to all residential building types. The most cost effective are also cost effective for commercial buildings. A vent damper that shuts automatically when the heater is off reduces heat losses when the hot water heater is not heating. Flow control devices on faucets and shower heads use the available water pressure more efficiently to disperse the water better and create a higher apparent pressure for less actual water use. Insulating the hot water storage tank with a 1 ½ inch thick insulation blanket reduces heat losses from the storage tank.

All three retrofits benefit from economies of scale and should cost less for the savings they achieve in a bigger building than in a small building. A hot water heater vent damper, for example, costs only 25 percent more in a moderate multifamily building than it does in a single-family house (according to OTA's calculations), but it saves more than 10 times as much energy. The calculations of retrofit costs per annual Btu saved are shown in figure 29.

There are two other much more expensive retrofits to the hot water system which each save about as much energy (under OTA's assumptions) as installing water flow controllers. The active *solar hot water heater* according to OTA's calculations would be a retrofit of high capital cost (compared to savings) for both a single-family detached house and a multifamily building in Buffalo, if it were used to save energy in the form of fuel (see fig. 29).

When used to save electricity, however, both the solar hot water heater and another retrofit, the air-to-water heat pump (see fig. 30) fall into the category of moderate capital cost retrofits. The air-to-water heat pump is now available in small and medium sizes. OTA assumed that a set of them (five medium and one small) could be used to heat hot water for a large multifamily building. Because medium-sized heat pumps cost somewhat less per unit of heat produced, there would probably be some economies of scale in using heat pump hot water heaters for

**Figure 29.—Calculated Capital Costs of Solar Hot Water Heaters and Three Other Hot Water Retrofits**

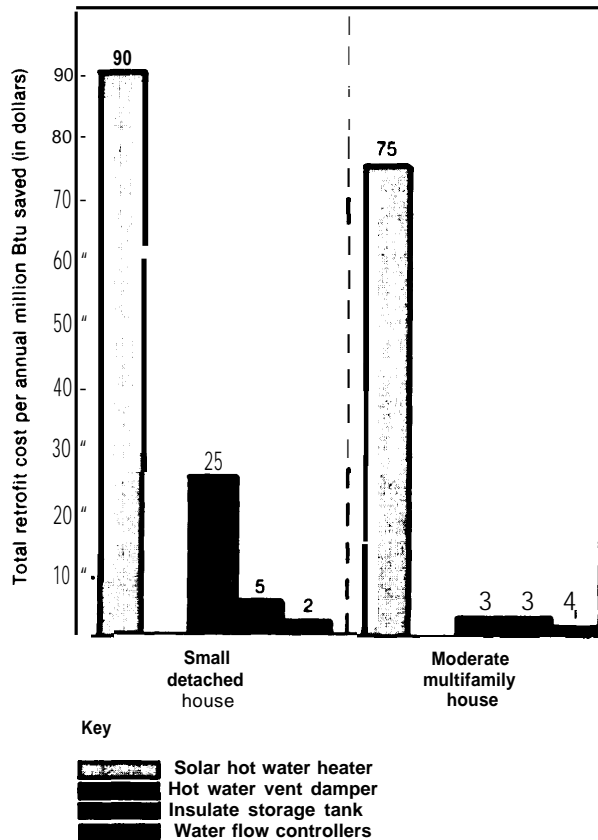

NOTE: 2,000 ft<sup>2</sup> and 15,000 ft<sup>2</sup> building with water systems in Buffalo  
 SOURCE: Office of Technology Assessment. See app. D for sources for individual retrofits.

larger buildings than for a small house. Further technical developments that produced large-sized heat pump hot water heaters should increase the potential for economies of scale. Solar hot water heaters are most cost effective in areas of greatest insolation. By OTA's calculations, a solar hot water heater would cost about 30 percent less per unit of heat produced in Tampa than in Buffalo.

### Retrofits to the Lighting Systems

Lighting absorbs a large share of the energy used by commercial buildings in the form of electricity—the most expensive form of energy. For buildings built in 1975-76, and sampled in the Department of Energy survey in preparation for developing building energy performance

**Figure 30.—Diagram of a Heat Pump Hot Water Heater**

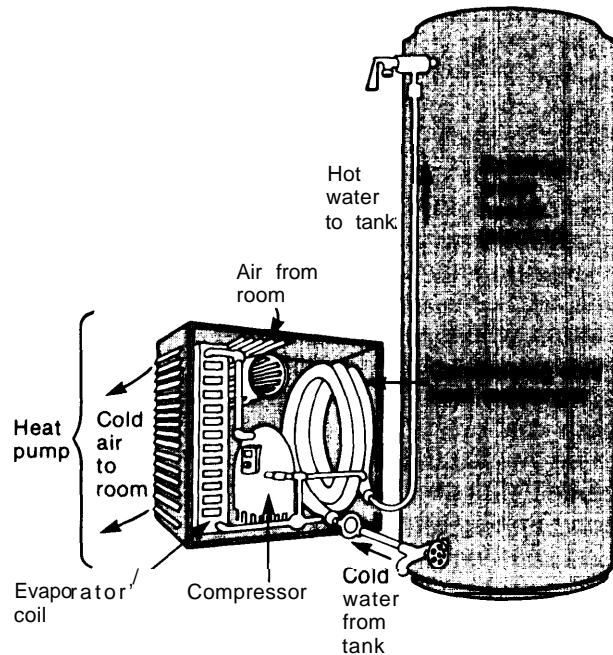

SOURCE: Office of Technology Assessment.

standards, offices had an average of 2.8 W/ft<sup>2</sup> of installed lighting while multifamily buildings had only 1.6 W/ft<sup>2</sup>. The sample also demonstrated the variation in lighting practice in office buildings. Thirteen percent had less than 2 W/ft<sup>2</sup> installed capacity while 17 percent had over 4 W/ft<sup>2</sup>.<sup>11</sup>

**Many Types of Lighting System Retrofits for Commercial Buildings are Expensive, But are Included in the Low or Moderate Capital Cost Category Because They Save Expensive Electricity.** The most powerful of these would replace incandescent lights with far more energy-efficient fluorescent lights. Since much of the energy used for incandescent lights is used (and wasted) as heat rather than light, this category of retrofit has two important side effects—it greatly reduces cooling requirements in a commercial building and increases heating requirements. OTA found no information on the number of commercial buildings that still use incandescent lights; from observation, it appears that most

<sup>11</sup> Results from the BEPS phase I analysis of sample buildings were reported in SERI, op. cit., Vol. 2, p. 365.

use fluorescent lights already. For multifamily buildings and single-family houses, however, a shift to fluorescent lighting could still produce substantial savings. For completeness, OTA has included this category of retrofits in its list of retrofit options for commercial buildings, but it has not been included in the estimates of cumulative savings from retrofit packages.

Lighting retrofits will have an impact on the interior appearance of a building more than any other kind of retrofit except passive solar retrofits, sunscreens, or reflective film (all of which affect daylighting). The tone, intensity and form of the light can all be changed. For this reason, planning a lighting retrofit can require some assistance from an interior designer. Four lighting retrofits analyzed are described briefly below. Their costs and savings are compared in table 23. (Other types of lighting retrofits—such as sodium vapor lights (for gymnasiums) or installations to maximize daylighting—can be very effective in particular buildings but their general cost effectiveness cannot be analyzed.)

*Change incandescent fixtures to fluorescent fixtures.* Fluorescent lights use only about one-third as much energy as incandescent lights, but they normally come in different shapes and have a cooler light. This retrofit will generally change the shape of fixtures from round to rectangular and lighting tone from warm to cool. Cooling savings are added to lighting savings in

table 23 and requirements for increased heating are subtracted from the total.

*Install fluorescent hybrid lamps* (see fig. 31). In this variation on the same retrofit, any of several makes of fluorescent lights that fit into incandescent sockets are substituted for incandescent lights. Calculating the costs and benefits of this retrofit is tricky. OTA assumed an initial cost of installing the lamps at 15 times the cost of incandescent bulbs, and savings of about 55 percent for the same brightness. The lamps are estimated to last 7,500 hours, or about 10 times as long as conventional lamps (more than 3 years for 45 hours a week use). Using these assumptions over a 10-year period (assuming electricity at an average of \$0.10/kWh over the period) the 10-year savings (net of lamp replacement cost) from a 100-W lamp installation would be \$121 per lamp.

*Use high-efficiency fluorescent lamps.* In this retrofit 40-w fluorescent lamps are replaced with lamps of 32 to 35 W. The capital cost is assumed to be the cost of changing all the lamps at once. The cost can be spread out over a period of time by replacing original fluorescent lights as they burn out.

*Use low wattage task lighting.* This retrofit reduces overall wattage per square foot by installing fixtures designed for each task area. This saves energy in two ways. It permits lower watt-

**Table 23.—Calculated Capital Costs of Four Retrofits to Commercial Lighting Systems (large commercial building<sup>a</sup>)**

| Retrofits  | Costs and savings from the retrofit/ft <sup>2</sup> |   | Capital cost category                                 |
|--|---|---|---|
|  | costs (dollars/ft <sup>2</sup> )                    | Savings (thousand Btu/ft <sup>2</sup> ) | Dollars per annual million Btu of energy <sup>b</sup> |
| Replace incandescent fixtures with fluorescent . . . . . | \$2.30  | 214                                     | Low (\$11)  |
| Install fluorescent hybrid lamps . . . . .               | 0.75  | 205                                     | Low (\$4)   |
| Install task lighting . . . . .                          | 0.70  | 26                                      | Moderate (\$26)                                       |
| Install high-efficiency fluorescent lights . . . . .     | \$0.15  | 16                                      | Low (\$0)   |

NOTE: Savings should not be added,

<sup>a</sup>Estimates are for a clad-wall commercial building with an air system in the St. Louis climate

<sup>b</sup>Retrofit cost per annual million Btu of energy saved is adjusted by a fuel factor 0.46 times end-use Btu to reflect the difference between fuel 011 at \$7 per million Btu and electricity at \$17 per million Btu for electricity at \$006 per kWh

SOURCE: Office of Technology Assessment

**Figure 31.—Hybrid Lamps Are Fluorescent Bulbs That Fit in Incandescent Sockets**

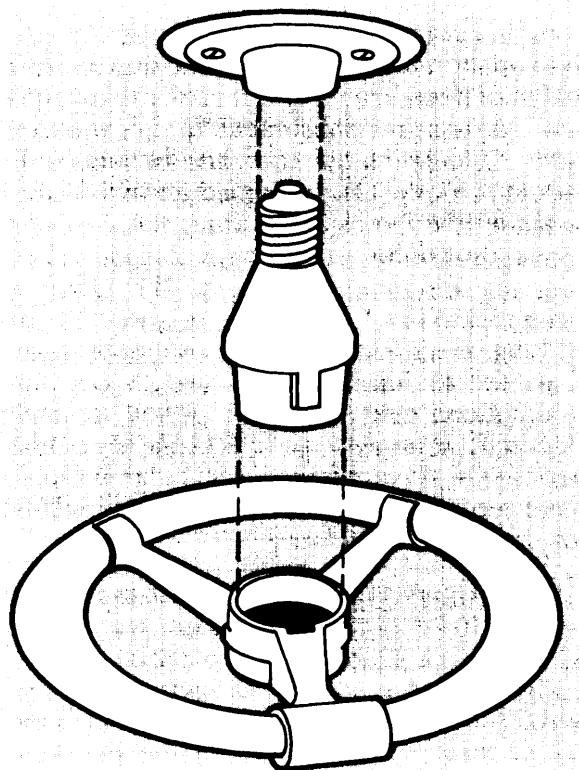

SOURCE: Energy works and Office of Technology Assessment.

age for the same illumination in the task areas since the fixture usually brings the light closer to the work being done, and it permits lower levels of general illumination outside the task area. This retrofit probably requires the most careful design work in order to retain the maximum flexibility for future changes in the arrangement of task locations.

### **Conclusion—Variation in Retrofit Applicability by Building Type**

This long section of the report has laid out OTA's assessment of the variation in the retrofit potential of different building types. The analysis has shown that a relatively small number of building characteristics systematically affect the likelihood that a particular retrofit will be generally effective. The next section of the report describes the site-specific nature of building retrofit, i.e., those aspects of particular buildings which affect their individual potential for energy savings.

## **ENERGY SAVINGS FOR PARTICULAR BUILDINGS MAY BE BOTH SITE SPECIFIC AND UNPREDICTABLE**

This section of the report describes two inter-related characteristics of building retrofits. The first is that, for many reasons, the site-specific aspects of a building's susceptibility to retrofit may outweigh the systematic aspects derived from its structure, size, use, and mechanical system type. The second characteristic of building retrofit is that energy savings are difficult to predict now and because of the site-specific nature of much effective retrofit, there is a limit to the future predictability of building retrofits even with far better data on retrofit performance than exists now.

### **The Site-Specific Nature of Building Retrofit**

Many aspects of a building will affect its energy use and prospects for retrofit—its regional location, orientation to the Sun and wind, condition of structure and equipment, intensity of occupancy, carefulness of management, and many other factors. Compared to the small number of factors that affect the energy performance of an automobile, many more factors must be taken into account in assessing the energy performance of a building.

one of the few surveys to date of energy use in different kinds of commercial buildings, in the Baltimore central business district, found that energy use varied strikingly for buildings used for similar purposes. As can be seen from table 24, office energy use ranged from a low of 21,000 Btu/ft<sup>2</sup> to a high of 432,000 Btu/ft<sup>2</sup> (more than 20 times as much). The most energy-extravagant banks use five times as much energy as the least extravagant; the most energy-extravagant department stores use six times as much energy as the least. In this survey only some of the variation could be explained by general characteristics such as glass area, type of heating and cooling, or building height.

There are several effective retrofits that are highly dependent on individual characteristics of buildings and are so site specific that their applicability cannot be easily predicted by type of building. Some of these retrofits are described below.

**Blocking Thermal Leaks and Thermal Bypasses.** Techniques developed at Princeton and elsewhere have proved effective in locating such leaks as warm air leaking into unheated attics and cold air leaking into basements. Such leaks are found typically in single-family detached houses. Instruments that have proved helpful in locating such leaks include a blower to be installed in the door or window of a house to pressurize it to find the leaks and an infrared scanner to identify differences in temperature where air is leaking. For other building types,

warm air may be wasted as it flows up in spaces along party walls of attached buildings or in spaces created by later additions to buildings. Such thermal bypasses can often be identified by careful three-dimensional analysis of buildings, taking note of dead space and passages from floor to floor. If significant leaks or bypasses are blocked, savings can be significant and cost low.

**Energy Management System Controls.** Computerized controls can go well beyond thermostat setbacks and can be used to manage ventilation dampers, heating system pressure valves, and temperature settings. These controls take advantage of existing equipment. Savings will depend on the specific nature of existing equipment and may also include labor savings as well as energy savings. Such computerized systems are often designed to include security and fire-safety features.

**Cogeneration.** For certain very large commercial and multifamily buildings in cities with high electricity rates, it may make sense to produce both heat and electricity using any of several types of building-size cogenerators. Several large buildings in New York City, where electricity rates are the highest in the country, have taken this step. The economic and technical feasibility of cogeneration for a variety of uses is to be analyzed in detail in a forthcoming OTA report *Industrial and Commercial Cogeneration*, to be published by the summer of 1982.

**Daylighting.** There are several devices available to increase the use of daylight as a substitute for electric lighting. "Lighting shelves" installed in or near windows can reflect light up to reflective panels on the ceiling and reflect daylight deep into a building. Outside reflecting panels can also be used to increase daylighting. The savings from such retrofits may be considerable but are highly dependent on the availability of light outside the building, the configuration of windows, the configuration of walls inside the building and the nature of computerized or other controls that control switching between daylighting and electric lighting.

**Adjustable Radiator Vents.** Steam systems in older buildings frequently have problems with

**Table 24.— Energy Use per Square Foot in Buildings of Downtown Baltimore**

|                             | Thousand Btu/ft <sup>2</sup> |                          |
|-----------------------------|------------------------------|--------------------------|
|                             | Median                       | Range minimum to maximum |
| Offices . . . . .           | 90                           | 20-430                   |
| Department stores . . . . . | 70                           | 55-360                   |
| Hotels/motels . . . . .     | 145                          | 100-235                  |
| Small stores . . . . .      | 90                           | 15-725                   |
| Banks . . . . .             | 130                          | 50-250                   |
| Restaurants . . . . .       | 340                          | 65-900                   |

SOURCE: Hittman Associates, February 1977. "Physical Characteristics, Energy Consumption, and Related Institutional Factors in the Commercial Sector" (fig 16), p. 73.

overheating on floors away from the space thermostat that controls the flow of steam to the radiator. Adjustable air vents can be installed to control this problem. The amount of savings may be considerable if the overheating is considerable and if the adjustable vents are actually used to control radiator heat (rather than the more typical method in such buildings of **opening the windows**). A somewhat more expensive retrofit adds thermostats to the adjustable valves and controls the radiator temperature automatically.

**Whole House Fans.** A powerful fan installed in the attic or upper floor of a small building is designed to ventilate the whole house by drawing cooler air in from the outside. Such a fan permits air-conditioning systems to be turned off when outside air is cool enough. The effectiveness of this retrofit is dependent on the location of the building in terms of the likelihood of cooler outside temperatures and is also dependent on the tolerance of the occupants for the higher humidity of unconditioned air.

Reducing **Orific (Nozzle) Sizes. Boilers and furnaces often have firing rates well in excess of the peak heating load requirement, and therefore operate inefficiently all of the time, with increased flue and standby losses. This can be a particular problem** where building envelope conservation measures have greatly reduced the heating requirements. The firing rate can be reduced by adjusting the fuel/air mixture and reducing the fuel orifice or nozzle size to reduce the overall fuel volume. This problem was very evident in a recent survey of the retrofit options for multifamily buildings in Minneapolis. Out of six buildings, four had oversized furnaces. For these buildings downsizing was a top priority retrofit.<sup>12</sup>

**Refrigeration Heat Reclaim To Heat Hot Water.** Special heat exchangers can be installed on the condenser side of an air-conditioning system to extract condenser heat for heating hot water. This measure can also be used to extract

heat from freezers and refrigerators and is thus useful in supermarkets and restaurants. There are two sources of savings. Energy is saved that would otherwise be used to heat the water and the cooling system works more efficiently because the temperature of the condenser is lowered. The potential for such a retrofit in a particular building depends on the relative locations of cooling equipment and water-heating equipment and the cost of transporting heat from one to another.

In addition to these particular retrofit measures that are site specific, there are two general categories of steps that are often very important in determining energy savings.

**Operations and Maintenance Steps.** For some buildings there is a lot of wasted energy that could be eliminated, before any retrofit investments are made, simply by careful maintenance of equipment. There are several convenient lists and explanations of such steps.<sup>13</sup> Some examples of them are: clean air-conditioning condenser coils, clean and repair steam traps, remove excess lamps (delamp), repair steam and water leaks, and repair ventilation dampers. Energy savings will be greatest from such measures when the building and its equipment have been least well managed. Prospects for savings, however, depend on the prospects for better management of the equipment in the future. In some cases this may require a change in staffing or supervision of maintenance crews.

**Auxiliary Repairs.** Many smaller buildings that lack energy efficiency features such as storm windows and roof and wall insulation, also have more basic problems such as structural weaknesses in roof or floor or poorly fitting basic windows. Although the data on specific problems that affect energy use is poor, the extent of the problem can be judged by the fact

<sup>12</sup>Final Report on Energy Conservation Modifications: Buildings 2-8, 2-9, 2-10, 2-181, 2-18B and 2-22" Chasney Associates, presented to the Minneapolis Housing and Redevelopment Authority, May 15, 1979.

<sup>13</sup>Recommended operations and maintenance steps can be found in: *Total Energy Management: A Practical Handbook on Energy Conservation and Management*, National Electrical Contractors Association (NECA) and National Electric Manufacturers' Association (NEMA) 1976, 2d ed., 1979. An evaluation of operations and maintenance steps recommended in hospital audits can be found in: Eric Hirst, et al., *Analysis of Energy Audits in 48 Hospitals*, Oak Ridge National Laboratory, July 1981. (Both reports also assess capital investments in energy efficiency.)

that more than half of all detached houses lacking roof insulation, storm windows, and storm doors, also are substandard, while substandard housing is only 3 percent of all housing.<sup>14</sup> This problem is discussed in more detail in chapter 7 because it greatly affects the implementation of the weatherization program. For buildings with basic deficiencies these must often be corrected before or during a basic energy retrofit. Primary windows must be repaired or replaced before storm windows will perform the function of creating an air barrier to block heat transfer. The roof may be repaired as it is being insulated.

### **Interactive Effects Among Retrofits Are Site Specific**

Savings from individual retrofits can be estimated by careful testing of retrofits one-at-a-time. When combined into packages, however, the savings from the package will be different from the sum of the savings from the individual retrofits. If retrofits are installed as a series the savings contributed by each will depend on how many retrofits have been already installed. For these reasons, cumulative savings for an individual building must be estimated for that particular building taking into account the package of retrofits or series of packages of retrofits that the owner wishes to install. An auditor cannot possibly compute in advance cumulative savings from all the possible combinations of retrofits so that the owner may choose among them, but must get some input from the owner on his preferences first.

Some of the most important interactive effects are described below. In a few cases interactive effects may actually increase energy savings from a package of retrofits over what savings are available from individual retrofits. More often, the impact of interactive effects is to reduce savings below the simple sum of the individual retrofits in the package.

**Measures That Act on the Same Feature of the Building Envelope Will Combine To Save Less Than the Sum of Each Alone.** For example, window insulation will save less if storm win-

dows are already reducing heat loss through a building's windows. Wall insulation, attic insulation, and storm windows, on the other hand, all improve resistance to heat loss (and cooling loss) of different features of a building envelope and savings of these should be additive.

### **Measures To Improve Mechanical System Efficiency May Have a Mutually Reducing Effect.**

Replacing the burner, for example, with a more efficient burner will increase combustion efficiency and reduce the amount of heat going up the stack. If a stack heat reclaimer is installed after the increase in burner efficiency it will save less because there will be less stack heat to reclaim. A vent damper on the other hand should not be so affected by an increase in burner efficiency because it prevents heat loss up the line when the burner is not firing.

**Improving the Building Envelope Efficiency May Decrease the Seasonal Efficiency of the Heating System. If better insulation reduces the heating load of the building, the boiler or furnace will operate less time each day in order to heat the building. This reduces the overall efficiency of the heating system because of heat loss while the system is off and because more fuel must be used to fire up a cold boiler or furnace than a hot one. A combined retrofit package that can achieve more savings than the sum of individual retrofits would downsize a heating system to match the new more efficient load. If the heating system was oversized before (as is frequently the case) this package will both reduce the load and increase the efficiency of the equipment,**

**Domestic Hot Water Measures May Reduce Each Others' Effects. Flow controls and storage insulation reduce the hot water load which in turn reduces the effect of an efficiency improving measure like a vent damper.**

**Improved Lighting Efficiency May Increase the Heating Load and Reduce the Cooling Load of a Building,** Inefficient lighting due to either excessive illumination for the tasks involved or excessive wattage for the illumination required (such as happens when incandescent lights are used instead of fluorescent lights) will give off more heat than efficient lighting.

<sup>14</sup>Andreassi, et al., *The Impact of Residential Energy Consumption on Households*, the Urban Institute, Washington, D. C., June 1980. A more complete discussion of this data can be found in ch. 5.



A careful energy audit will take all these factors into account when recommending an optimum package of retrofits. An audit that does not, may recommend acceptable retrofits but not a package that will produce the most savings for the money as a group.

### Unpredictability of Savings From Building Retrofits

There is ample evidence that energy savings from retrofits to buildings on average are likely to be significant and cost effective. However, savings are unpredictable for particular buildings. This characteristic of building retrofit concerned many building owners interviewed for the analysis of building owner motivation in chapter 4. While this situation should improve with the maturity of retrofit technology and practice, the site-specific nature of building retrofit described above will make it difficult, for example, to achieve the predictability of gas mileage performance for different models of automobile. The reasons for this situation are described below.

**Poor Documentation of Retrofit Results.** Despite considerable theoretical analyses and thousands of audits, there is still very little documented information on the results of actual retrofits on different types of buildings. In the biggest survey of documented retrofits to date, Howard Ross and Sue Whalen collected energy savings and retrofit information on 222 buildings.<sup>15</sup> Only 65 of these buildings had complete

<sup>15</sup>The 19 smaller surveys of buildings from which data was compiled for this study included: 1) 21 public schools retrofitted for the Maine Advancement Programs; 2) 14 office buildings included in the total Energy Management Research Report by NECA and NEMA; 3) 11 office buildings for which data was provided by Hagler, Bailly & Co.; 4) 15 buildings owned by the State of New York; 5) 7 office buildings for which data was provided by Flack and Kurtz of New York City; 6) 9 buildings for which data was provided by EBASCO Services, Inc. of New York City; 7) 10 buildings owned by Ohio State University; 8) 10 school buildings analyzed in *Saving School House Energy* sponsored by the American Assn. of Schools Administration; 9) 10 buildings owned by the State of New Jersey; 10) 80 schools monitored by the Buffalo Board of Education; 11) 24 community buildings for which data was collected by the Columbia Association of Columbia, Md.; several other reports on individual buildings. From: "Conservation progress in Commercial Buildings." *Building Energy Use Compilation and Analysis: Part C. Howard Ross and Sue Whalen*, unpublished report. May 1981 (revised August 1981) to be published in *Energy and Buildings Magazine*, Lansanne, Switzerland.

information to allow a full cost benefit analysis. The distribution of building types is scarcely representative of urban building types. Over half the buildings are schools, and about a fifth are large office buildings. There is only one shopping center, one multifamily building, one small office building, and four hotels. There are no small stores or department stores (see table 25).

Individual private retrofit efforts for such buildings as restaurants, retail store chains, and supermarkets have also been documented but the results are considered proprietary and are not available for use by other building owners. Data beyond the Ross and Whalen survey have also been assembled by Lawrence Berkeley Laboratory and by a group analyzing 40 building reporting retrofit results in the *Energy User News*. Data from these sources also are very skimpy on retrofits to multifamily buildings and to small office buildings and stores.<sup>16</sup>

### Available Data on Retrofits Show Energy Savings are Variable and Unpredictable

The Ross and Whalen data confirm the general predictions of theoretical analyses of energy retrofits to buildings as a group. The results of their survey are shown in table 26. The survey also shows, however, that savings vary greatly from building to building including a significant prob-

<sup>16</sup>H. P. Misuriello and R. M. Bily, Jr., "A Study of Actual Metered Energy Savings for Energy Conservation Retrofit Measures Reported for Commercial Buildings.", April 1981, cited in Hirst, op. cit., A. H. Rosenfeld, et al., *Commercial Building Retrofit Survey* draft September 1980.

**Table 25.—Documented Energy Savings by Type of Commercial Building**

| Building category               | Site                       |             | Source                     |             |
|---------------------------------|----------------------------|-------------|----------------------------|-------------|
|                                 | Average percent of savings | Sample size | Average percent of savings | Sample size |
| Elementary . . . . .            | 24%                        | 72          | 21 %                       | 72          |
| Secondary . . . . .             | 30                         | 38          | 28                         | 37          |
| Large office . . . . .          | 23                         | 37          | 21                         | 24          |
| Hospital . . . . .              | 21                         | 13          | 17                         | 10          |
| Community center . . . . .      | 56                         | 3           | 23                         | 18          |
| Hotel . . . . .                 | 25                         | 4           | 24                         | 4           |
| Corrections . . . . .           | 7                          | 4           | 5                          | 4           |
| Small office . . . . .          | 33                         | 1           | 30                         | 1           |
| Shopping center . . . . .       | 11                         | 1           | 11                         | 1           |
| Multifamily apartment . . . . . | 44                         | 1           | 43                         | 1           |

SOURCE: Ross and Whalen, "Building Energy Use Compilation and Analysis—part C: Conservation Progress in Commercial Building," draft, May 1981 (revised August 1981),

**Table 26.—Summary of Findings From Survey of Commercial Building Retrofits**

|  | Average                | Range <sup>a</sup>            | Sample size      |
|--|------------------------|-------------------------------|------------------|
| Savings <sup>b</sup> including 22 failed retrofits . . . . . | 190/0                  | 1.5-36.5%                     | 195 <sup>c</sup> |
| Savings excluding failed retrofits . . . . .                 | 22 %                   | 7 - 37 %                      | 173              |
| Electricity savings . . . . .                                | 80/0                   |                               | 156              |
| Fossil fuel savings. . . . .                                 | 28/0                   |                               | 151              |
| Average cost of retrofit . . . . .                           | \$0.65/ft <sup>2</sup> | \$0.13-\$1.17/ft <sup>2</sup> | 77               |

<sup>a</sup>Within one standard deviation  
<sup>b</sup>Primary energy including energy used to generate electricity.  
<sup>c</sup>Excludes buildings for which primary energy savings could not be estimated  
 SOURCE "Building Energy Use Compilation and Analysis—Part C, Conservation Progress in Commercial Buildings " Draft Howard Ross and Sue Whalen May 1981. and Office of Technology Assessment

ability of *increased* energy use. Further the survey shows that savings also vary substantially from what was predicted for those buildings for which predictions are available. The specific findings of the study are as follows:

On average, retrofits saved considerable energy and were low in capital cost. —Savings for 173 buildings out of a subsample of 195 buildings with decreases in energy use following the retrofit averaged 22 percent of preretrofit energy use. For almost 90 percent of the retrofits, the cost of the retrofit could be recovered in a 3-year payback or less<sup>17</sup> (see fig. 32).

On the *other hand*, savings were very variable. Twenty-two of the 195 buildings failed to save any energy at all following a retrofit and some actually *increased* their energy use. The experience of the buildings that did save energy ranged from a low of 7-percent savings to a high of 37-percent savings.

*Actual savings differed considerably from predicted savings.* A set of 60 buildings out of the full sample had some information on predicted savings as well as actual savings. One group within the 60—a set of 18 community centers from Columbia, Md.—illustrates the variation from predicted to actual savings. For this group actual savings on average were only 85 percent of predicted savings. Six buildings had higher savings than predicted while 12 had lower savings. Savings ranged (within one standard deviation) from 80 percent less than predicted to 50

<sup>17</sup>The Ross and Whalen results are reported for different sample sizes out of the 222 buildings in order to get consistency of data.

**Figure 32.—Simple Payback Period**

N = 65 (does not include 3 buildings which failed to save)

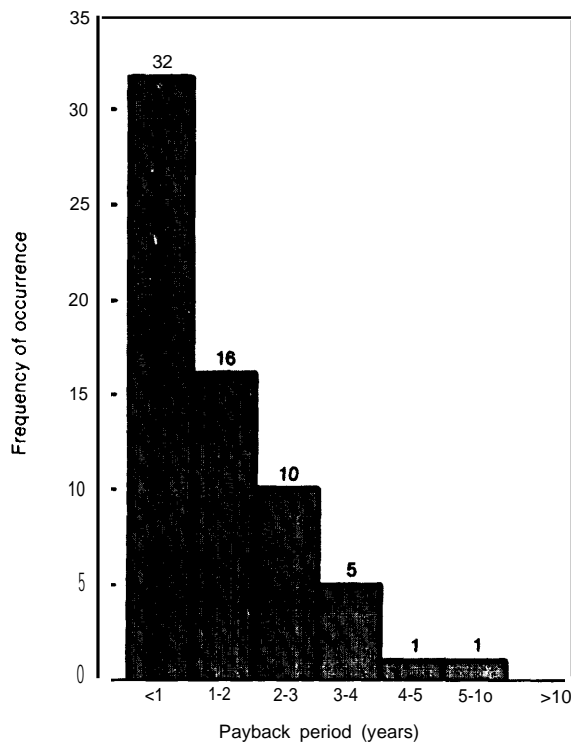

SOURCE Ross and Whalen, "Building Energy Use Compilation and Analysis—Part C: Conservation Progress in Commercial Building," draft, May 1981.

percent *more* than predicted. Several other groups described by Ross and Whalen experienced equal or more savings than predicted. A group of Maine schools had predicted 5-year paybacks, for example, and achieved 3-year paybacks. On the other hand, actual savings for the nine school buildings retrofitted by the American Association of Schools Administration were far less than predicted by computer simulation. An analysis of the poor retrofit performance was done for each school, and identified errors in selecting retrofits, installing them and maintaining them afterward. In one school, for example, maintenance personnel allowed a blown steam trap to remain in service, although a new one would have paid off in weeks. Apart from these 60 buildings reported on by Ross and Whalen, OTA found no study comparing actual to predicted savings.

Many buildings gradually increased their savings in the years following the retrofit, but some

decreased their savings. Out of 15 **buildings with** more than 1 year of data on energy savings following the retrofit, **9** buildings increased their savings following the retrofit, but **6** buildings decreased their energy savings over time.

*Retrofits were limited to simple, cheap and well-known measures.* Improvements in operations and maintenance and lighting measures (including delamping) were the most frequent retrofits (see fig. 33). Only 76 buildings or about one third of the total installed more complex and expensive retrofits to the mechanical system or windows, or installed insulation or

energy management systems. No buildings in the survey had installed some of the more “innovative” retrofits described earlier in the chapter—night insulation, passive solar additions, waste heat recovery systems or automatic daylighting control systems. It was not possible to draw any conclusions on the relative effectiveness of individual measures from the survey. It is evident that owners are cautious in their choice of retrofits and are sticking to those that are both inexpensive and well known.

**Improved Data Should Increase the predictability of Building Retrofit Up to a Point.** Im-

**Figure 33.—Categories of Completed Retrofits: Summary of Commercial Building Retrofits**

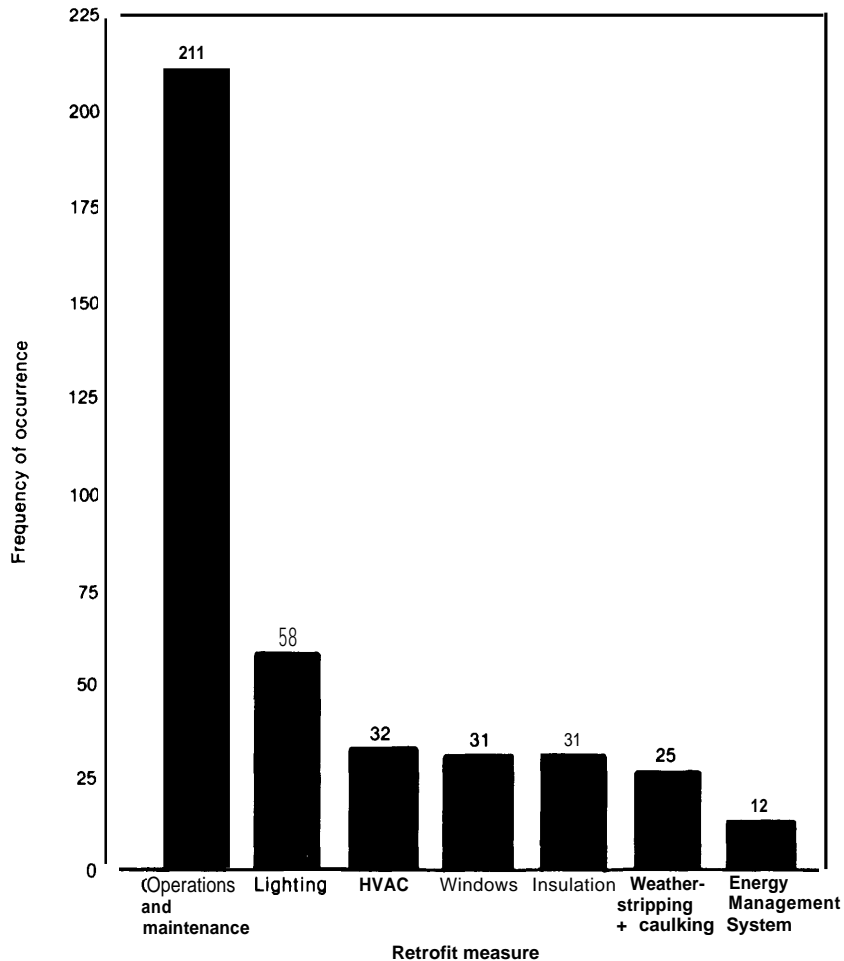

SOURCE: Ross and Whalen, “Building Energy Use Compilation and Analysis—Part C: Conservation Progress in Commercial Building,” draft, May 1981, “

proved data of several kinds would certainly improve the predictability of savings from building retrofits.

Improved data on *the results of individual retrofits*. While there are now substantial data on savings from installing the more common retrofits such as energy management systems, there are still very little data on actual installations of some of the most effective retrofits identified in testing and computer simulation such as: night insulation for multifamily buildings or heat pump hot water heaters replacing electric resistance hot water heaters.

Improved data on *the results of retrofit packages*. These data would result from systematic retrofit of categories of buildings with similar uses, sizes and mechanical systems. Multifamily buildings are one category of buildings for which there are almost no data on systematic retrofits. Technical data could be obtained from retrofits of condominiums, which appear to be more likely than other multifamily types to be retrofit.

Data on actual savings *compared to predicted*. Systematic studies of actual savings compared to savings predicted in an energy audit should be able to identify categories of retrofits for which savings tend to be overestimated and those for which savings are usually underestimated. A careful examination of the reasons for differences in actual savings could identify categories of retrofits which are particularly susceptible to errors in installation or subsequent maintenance.

There is a limit, however, on the precision with which data can be gathered to improve the

predictability of energy savings for particular buildings. The limit arises out of the site-specific nature of building retrofit described above. In collecting data on retrofit results for a group of buildings an analyst must:

- Allow for differences in the combinations of retrofits which will affect the behavior of individual retrofits due to the interactive effects described above.
- Allow for differences in hours of occupancy and vacancy among the buildings.
- Allow for weather conditions if the data are from several years. This is especially true for any solar retrofits for which hour-by-hour data are often necessary.
- Take into account the impact of very site-specific retrofits described above, such as blocking thermal bypasses or recovering waste heat from cooling equipment.

By the time these factors have been taken into consideration the analysis has become very complex and the power of generalization from large numbers has been reduced.

OTA's conclusion is that predictability of building retrofit could certainly be increased through improved data beyond the fragmentary data available in 1981. However, a certain amount of variation in actual savings from that predicted by a retrofit will probably always be characteristic of building retrofit, and this variability will have an impact on the motivation of those building owners, especially smaller building owners whose financial situation does not allow them to absorb risk. (These are discussed in ch. 4.)

## IMPLICATIONS FOR RETROFIT OF BUILDINGS IN CITIES

This analysis of the systematic and site-specific nature of the retrofit of buildings has some implications for the actual practice of building retrofit in cities through private enterprise and public programs. This section summarizes some observations about the nature of large-scale retrofit in cities, some of which is also ap-

plicable to buildings in general, wherever they may be located,

### Energy Retrofit Business

One of the reasons why actual building retrofits have lagged behind the identification of

ample opportunities for retrofit (as described earlier in the chapter) is that the energy retrofit business, as a business, is still in the process of organization. Although some parts of the business—such as home insulation and energy management systems for large buildings—have considerable track records by now, it still is difficult to find a single place for the owner of an existing building to go to for advice and action. There has been a lot of talk about a “one-stop” type of organization that would serve such a need in the private sector. Why are there so few now? A partial answer is that retrofit of a building is complex. A building’s energy ailments must be diagnosed first, then cost-effective solutions proposed, then the retrofit work must be performed. Retrofits may affect almost every aspect of a building: structure, hot water, lighting, and mechanical system. Such a task may require a set of building services that is almost as complex as that used to construct the original building.

For small *buildings*, especially frame buildings, the most cost-effective retrofits will be insulation and improvements in window efficiency. This requires little more than light carpentry skill but is demanding work to organize and maintain of high quality. Insulation crews often work in semiaccessible places; it takes care to see that gaps in insulation are avoided and peculiar structural features in the walls are taken care of. Such work is difficult to streamline; it is exceedingly labor intensive. Separate companies often specialize in window retrofits and insulation.

A separate specialty is developing in the retrofit of small buildings—solar specialist. Active solar domestic hot water heating is an enterprise requiring carpentry, and licensed plumbing and electrical work. passive solar retrofit requires carpentry skills that are upward extensions of the skills currently in use by insulation and storm window contractors, but which are not typically in the portfolio of those organizations. The current trend has been toward further disaggregation of the small building retrofit industry as contractors specializing in renewable retrofit start up practices without regard to the lower technology

conservation work. This may change as more people come to understand the benefits of combining conservation retrofits with active or passive solar retrofits.

Many retrofits to the mechanical systems are cost effective even in small buildings and these cannot usually be performed by insulation contractors with carpentry skills. A retrofit contractor usually must subcontract out the installation of a new burner, hot water heat pump, vent damper, or modulating aquastat. Some natural gas utilities and larger fuel oil dealers maintain service departments which perform these functions. otherwise, they are carried out by mechanical system specialists in furnaces, boilers, and air-conditioners. A few retrofits can be done directly by the small building owner, such as installing a clock thermostat or faucet and shower flow controllers.

In the *retrofit of larger buildings*, the full range of building trades (including sprinkler system specialists for roof sprays), gets involved. With the higher intensities of lighting and inherent wastefulness of many of the HVAC systems installed on larger buildings, this study has shown the tremendous cost effectiveness of a much broader range of retrofits on larger buildings than on smaller ones. Large buildings have more complex central plants, and require more highly trained and experienced people to retrofit them. In addition, retrofit of the distribution portion of the heating and cooling system is limited to insulation of pipes and ducts for small buildings, whereas specialists are needed in large buildings who can change ventilation settings, install outside air controls, or make the switch from a terminal reheat system to a variable air volume distribution system. Work on the lighting system is much more intense in larger buildings, and electricians are required to make the shift to task lighting, or change over incandescent fixtures to fluorescent or sodium vapor. Large buildings often have engineers or maintenance personnel with skills enough to perform the simpler retrofits themselves.

Offsetting all this large building complexity is the fact that envelope retrofit plays a much smaller role except in major renovations. In ad-

dition, the construction industry which caters to the large building is as a whole much more used to packaging diverse construction operations under a single general contract. Therefore, the large building is much more likely to be systematically retrofitted than the small one, even though the job requires higher skill levels.

### Problems and Opportunities of Urban Retrofit

The construction business in urban areas has always operated differently than in rural areas. What particularly is different about retrofitting in the city?

*Because of the high proportion of relatively old buildings in urban areas, a lot of retrofit cannot occur at all without a certain amount of restorative work occurring first.* For instance, people working in weatherization programs in our cities are familiar with having to patch holes in walls before performing the wall insulation itself. This characteristic of urban buildings (discussed more extensively in ch. 5) tends to increase costs of retrofit above those presented in this report, which consider only the costs of the retrofit itself, not those of any repair which may be necessary beforehand.

What makes a city a city is its density. *Urban density can result in economies of scale, but high density always drives up construction costs associated with access problems.* The kinds of economies of scale that can result from high density include reduced travel time to any given retrofit site, an important cost consideration for many small retrofit jobs, for which travel is a large percentage of total job costs. For any step prior to retrofit, such as a sales call, an estimating visit, or an onsite energy audit, costs of travel are an even larger fraction of the total cost of the activity. Access problems associated with urban construction sites include increased travel times and parking fines caused by streets congested with either traffic or snow, difficult ladder access because ladders must rest on an adjacent property or a public sidewalk, and tremendously increased costs associated with accessing any kind of exterior retrofit location above ladder access level. The retrofitter install-

ing storm sash, caulking, replacement sash, wall insulation, or any other envelope retrofit measure above the third floor has the choice of erecting scaffolding or disturbing the occupants of the building. Either tactic adds cost to the job.

The opportunity for renewable retrofit is different in cities. There are plenty of masonry-walled structures appropriate for passive solar retrofit strategies, and acres of flat roofs available for the mounting of active solar collectors or small wind energy conversion devices. On the other hand, urban buildings may be so close together that they shade one another's sun or obstruct one another's wind.<sup>18</sup> In addition, urban particulate pollution degrades collector efficiency more rapidly than in relatively unpolluted locations. Vandalism, or the threat of vandalism, discourages any solar retrofit that will place a breakable panel, passive or active, within stone's throw of the street.

There is more crime in urban areas. This increases the cost of doing retrofit business by raising insurance costs, both for retrofit vehicles and equipment and for the business location itself. In addition, vandalism can degrade the performance of more than just solar collectors. Heating and air-conditioning thermostats, storm windows, and reflecting trim are also subject to intentional damage, with the resultant elimination of the energy savings these improvements were designed to cause.

### Urban Retrofit: Mass Production or Custom Work?

Based on the results of this report, can a general set of retrofit measures be confidently recommended for a given building type without further site analysis of actual individual buildings? The results suggest that it would be tempting to do this, but a poor risk.

It is attractive to consider that retrofit could be performed without site-specific consideration in the form of an energy audit. The total cost of retrofitting urban buildings is not just the cost of

<sup>18</sup>An analysis of hours of exposure to sunlight for buildings of different heights in Boston is described in Shapiro, op. cit.

the construction service itself, but also the cost of the energy audit. Depending on how close the energy audit comes to being a construction estimate that the retrofitter can work from, the energy audit can make up 2 to 10 percent of the typical cost of retrofit. Avoiding some of this cost would help. Some "class action" retrofit occurs now in the form of two Federal programs, "no cost/low cost" and the Residential Conservation Service (RCS). "No Cost/Low Cost" recommends a set of conservation measures without hesitation in a brochure that uniformly recommends the same action to a homeowner in Minneapolis as it does to a homeowner in Los Angeles. This is possible because the improvements recommended, such as flow restrictors for shower heads and faucet aerators are so cheap that it is practically impossible for a poor recommendation to be made. Domestic hot water usage is almost completely independent of climate, and even if a homeowner doesn't heat the home's domestic hot water at all, water bill savings are sufficient to pay for flow restrictors in less than a year. Besides, the first flow restrictor comes with the "No Cost/Low Cost" brochure anyway. This is not to say that "No Cost/Low Cost" is completely incapable of causing a homeowner to make a mistake, that is to invest money foolishly. For example, the program recommends that the temperature cutoff on hot air furnaces be adjusted downward to make the most of the heat contained in the furnace itself. A certain number of people are going to pay a serviceperson to come to their homes to make the temperature adjustment only to discover that the adjustment has been made. The designers of "No Cost/Low Cost" find this an acceptable risk, and rightly so. Far more money would be wasted having energy auditors tell people whether their hot air furnaces needed adjustment than just going ahead and adjusting them.

RCS is a partial "class action" program. Under RCS, energy auditors visit homes, collect site-specific data, and then make projections of cost and fuel savings that may accrue from the implementation of a variety of individual measures, from small wind energy conversion systems to weatherstripping. This makes sense, because it is foolish to make a blanket recom-

mendation of window weatherstripping, regardless of the severity of the heating or cooling climate, unless the condition of the existing prime window and storm window (if any) is known. But RCS is by no means a program customized to each home. The regulations that have governed RCS specify that the auditor shall make estimates of cost and savings for a limited set of energy-conserving measures.<sup>19</sup> Flame retention oil burners are included, but modulating aquastats are not. Under the original RCS regulations, as long as a home audited under RCS has an oil burner that is not of the flame retention variety, the auditor must make an estimate. No matter how appropriate the home is for installation of a modulating aquastat on the hot water space heating system, the auditor may not take any recommendations for it (unless the particular state in which a home is located has applied for, and secured approval to consider that energy-conserving improvement). So for RCS, some judgments were made in advance of the promulgation of the program as to which energy-conserving improvements were sufficiently applicable to make their consideration a cost-effective use of the energy auditor's time. Implicit criteria included commercialization of the measure (it had to exist in the marketplace, and there had to be evidence that a fair number of people were in business who could reliably install the measure), as well as evidence of energy-conserving performance. Under regulations proposed in the winter of 1981 which would extend the RCS concept to a Commercial and Apartment Conservation Service it was recognized that commercial buildings and apartment buildings are far more varied than small houses. The regulations required only five measures to be evaluated for every building and a much longer list of measures to be considered for evaluation if appropriate.<sup>20</sup>

There is sufficient predictability of applicable measures by building type to support a RCS-type program (whether Federal, State, or utility directed) for buildings other than single-family

<sup>19</sup>The rigidity of these regulations was reviewed by the Reagan administration and new more flexible regulations have now been issued (see ch. 9).

<sup>20</sup>Proposed Regulations for Commercial and Apartment Conservation Service, February 1981.

houses in which onsite auditors are asked to consider certain kinds of measures for certain building types. The predictability of retrofits, on the other hand, is not universal or consistent enough to justify a “No Cost/Low Cost” style program for larger buildings. For instance, for climates in cities like Buffalo, nearly half of the energy-conserving measures considered fall into the category of low capital cost under the assumptions used for these calculations. But variations specific to individual buildings will be sufficient to cause some of these measures to be of moderate capital cost compared to savings.

There are other powerful reasons for making onsite judgments even after a particular set of retrofit measures have been identified as usually physically applicable and potentially cost effective when applied to a particular building type. The advantages of onsite auditing are that the auditor can properly account for the special conditions of use and of building condition when considering a measure or measures for recommendations, and also when making estimates of costs and savings. Trained auditors are able, in their examination of the building itself and of the way in which the building is used, to account for:

- *Special conditions of use.* —These include unusual hours of operation, portions of the building unused during particular times of day or season, portions of the building which can be zoned to different temperature ranges, and usage patterns allowing cutoff of domestic hot water to lavatories.
- *Long-term strategy for the building.* —Many retrofit strategies often depend on what future remodeling plans are in the works and certainly influence the owners’ level of spending.
- *Esthetic consideration.* —Many envelope, lighting, and renewable retrofit measures have major effects on the appearance of the building. Only an auditor at the site can tell if the owners are willing to live with a passive solar wall collector on the front of their building.
- *Site-specific conditions affecting costs and savings.* —There is no such thing, even for a given building type in a given location, as a

standard per square foot price for attic insulation. Many RCS audit procedures currently mislead building owners by presenting relatively uniform costs for attic insulation, whereas site-specific conditions such as required access and ventilation can influence cost by a factor of 50 percent, and site-specific conditions such as air leakage into the attic or amount of ventilation proposed can influence projected savings by a similar amount. Only an onsite auditor has the ability to make the judgment calls that are essential to deliver a responsible level of accuracy to the owner.

- *Optimum package of retrofits.* —Taking into account the interaction among retrofits, an auditor can come up with an optimum package for that building which might include, for example, recommendations on down-sizing of equipment to accommodate a better insulated building envelope.

Thus, this report does lay some important groundwork for anyone considering a retrofit program for a single building or entire group of buildings by providing concrete lists of retrofit measures worth consideration for particular combinations of building types and climates.

Beyond this, however, “class action” retrofit, or retrofit without detailed site analysis, is to be avoided because of the individual variation, both in costs and in savings, that occurs as the result of site-specific conditions. Lastly, if audits are to be performed at the site, their computation methods must make fewer approximations than those made in the algorithms in this report in order to be marginally more accurate than the projections given here.

### **Retrofit, Rehab, or Demolish?**

Each prospective building owner or developer picks one of four strategies when considering a property for acquisition: do nothing, repair, rehab, or demolish. With the addition of energy costs to the factors to take into account in this strategic decision, the question is changed only slightly: do nothing, retrofit, rehab, or demolish?



The advantages of retaining the basic structure of an urban building are increasing, and range from historical significance to architectural quality to the avoidance of skyrocketing new construction costs. The financial factor is a key to all development decisions, and, from the energy point of view, the developer must examine the energy element of the projected operating statement of a building with new respect, and must attempt to answer two difficult questions: 1) How low can energy costs be brought before major rehab is required? 2) How low can energy costs be brought, even after major rehab?

This report shows that some buildings in some climates have far higher potential than others. Consider, for example, a developer in a city with a climate like Buffalo's who is looking at two small commercial properties that are equal except that one is of frame (cavity) wall construction, the other of clad-wall construction. The buildings are roughly similar in energy efficiency; neither is insulated to begin with, but the developer must rehab the clad wall at far greater cost than he can retrofit the frame (cav-

ity) wall to achieve the same improvement in energy efficiency. Sooner or later, if the only buildings available to developers can be made energy efficient only at very high costs, demolition will occur more frequently.

This report cannot consider a critical factor in the decision to demolish or rehab, which is the energy efficient qualities given a building at the time it was built, which no amount of retrofit or rehab can change. Those "hereditary" qualities can change drastically on the same site according to the structure's built-in characteristics, notably, surface-to-volume ratio and orientation. Buildings that can profitably absorb large amounts of retrofit, but which were poorly sited and which have very complicated shapes, may never approach the low levels of energy consumption which are possible with reasonable investment in new construction. And on the other hand, buildings that are well sited and whose shape approaches that of a cube may well be capable of being retrofitted to lower levels of energy consumption at far less total cost, than a building constructed from scratch on the site.

**Table 3A.—43 Building Types for Which Retrofit Lists Were Developed**

| Size and use                                   | Wall type | Mechanical system type                                  | Size and use                                 | Wall type | Mechanical system type                                  |
|--|-----------|---|--|-----------|---|
| Small residential (2,000 ft <sup>2</sup> )     | Cavity    | • Air<br>• Water<br>• Decentralized                     |  | Clad      | • Decentralized<br>• Complex reheat                     |
|  | Masonry   | • Air<br>• Water<br>• Decentralized                     |  |           | • Air<br>• Water<br>• Decentralized<br>• Complex reheat |
| Moderate residential (15,000 ft <sup>2</sup> ) | Cavity    | • Air<br>• Water<br>• Decentralized                     | Large commercial (100,000 ft <sup>2</sup> )  | Masonry   | • Air<br>• Water<br>• Decentralized<br>• Complex reheat |
|  | Masonry   | • Air<br>• Water<br>• Decentralized                     |  | Clad      | • Air<br>• Water<br>• Decentralized<br>• Complex reheat |
|  | Clad      | • Air<br>• Water<br>• Decentralized                     | Large residential (100,000 ft <sup>2</sup> ) |           | Masonry   |
| Moderate commercial (15,000 ft <sup>2</sup> )  | Cavity    | • Air<br>• Water<br>• Decentralized<br>• Complex reheat |  | Clad      | • Air<br>• Water<br>• Decentralized                     |
|  | Masonry   | • Air<br>• Water  |  |           | • Air<br>• Water<br>• Decentralized                     |

SOURCE: Office of Technology Assessment.

**Table 3B.—Retrofits Assessed by Office of Technology Assessment<sup>a</sup>**

|   | Retrofit applies only to:   | Costs and savings of retrofit not specifically analyzed by OTA |
|---|-----------------------------|--|
| <b>Envelope retrofits</b>                             |                             |  |
| Roof/attic insulation                                 |                             |  |
| Wall insulation                                       |                             |  |
| Storm Windows   |                             |  |
| Replacement double glazing                            |                             |  |
| Window and door weatherstripping                      |                             |  |
| Window insulation                                     |                             |  |
| Reflective insulation                                 |                             |  |
| Shading devices                                       |                             |  |
| Roof sprays   |                             |  |
| <b>Mechanical system retrofits</b>                    |                             |  |
| Replace burner and controls                           |                             |  |
| Replace boiler/furnace                                |                             |  |
| Install vent damper                                   |                             |  |
| Stack heat reclaimer                                  | Water systems               |  |
| Replace electric resistance heater with heat pumps    | Decentralized Water systems |  |
| Boiler turbulator                                     | Water systems               |  |
| Modulating aquastat                                   |                             |  |
| Setback thermostats                                   |                             |  |
| Enthalpy control/economizer                           | Air systems                 |  |
| Replace room air conditioners                         | Decentralized               |  |
| Replace central air conditioning                      | Air systems                 |  |
| Vary chilled water temperature                        |                             |  |
| Convert terminal reheat to variable air volume        | Complex reheat              |  |
| Reduce ventilation volume                             | Air systems                 |  |
| Evaporative cooling system                            |                             |  |
| Replace air-cooled condenser with water cooled        |                             |  |
| Fog cooling (evaporator coil spray)                   |                             |  |
| Insulate ducts  | Air systems                 |  |
| Insulate pipes  | Water systems               |  |
| Two-speed fan motors                                  | Air systems                 |  |
| Adjustable radiator vents                             | Water systems               | X  |
| Reduce orifice size on furnace/boiler                 |                             | X  |
| Install multifuel boiler                              |                             | X  |
| Whole house fan                                       |                             | X  |
| Condenser coil spray                                  |                             | X  |
| Chiller bypass system                                 |                             | X  |
| <b>Hot Water Retrofits</b>                            |                             |  |
| Summer domestic hot water boiler                      |                             |  |
| Flow control devices                                  |                             |  |
| Insulate hot water storage                            |                             |  |
| Vent damper on heater                                 |                             |  |
| Hot water heat pump                                   |                             |  |
| Refrigeration heat reclaim for hot water              |                             | X  |
| <b>Lighting retrofits</b>                             |                             |  |
| Replace incandescent light with fluorescent           |                             |  |
| Install fluorescent hybrid lamps                      |                             |  |
| Use low wattage task lighting                         |                             |  |
| Use high-efficiency fluorescent lamps                 |                             |  |
| Maximize use of daylighting                           |                             | X  |
| <b>Solar retrofits</b>                                |                             |  |
| Solar hot water heater                                |                             |  |
| Active solar combined space and hot water             |                             |  |
| Sunspace/greenhouse                                   |                             |  |
| Glaze masonry wall (trombe)                           |                             |  |
| Add wall panel without storage                        |                             |  |
| Add glazing without storage but with night insulation |                             |  |
| Add glazing with storage but without night insulation |                             |  |

<sup>a</sup>Each retrofit is described in appendix

**Table 3C.—Characteristics of the 12 Building Types  
(as determined for analysis of retrofit measures)**

| Building type                       | Size  | Walls   | Roof                                      | Windows                                  |
|-------------------------------------|---|---|---|--|
| Single-family detached              | 2,000 ft <sup>2</sup><br>2 stories                      | "Cavity" wood frame with wood or brick siding         | Wooden, peaked roof with attic            | Wooden, double hung                      |
| Single-family masonry rowhouse      | 2,000 ft <sup>2</sup><br>2 stories                      | Brick or stone bearing walls, two walls attached      | Flat or slightly pitched with crawl space | Wooden, double hung                      |
| Small frame apartment house         | 15,000 ft <sup>2</sup><br>18 apartment units, 3 stories | Wood frame with wood or brick siding                  | Flat wooden roof                          | Wooden, double hung                      |
| Small masonry apartment house       | 15,000 ft <sup>2</sup><br>18 apartment units, 3 stories | Brick or stone bearing wall                           | Concrete slab roof                        | Wooden, double hung                      |
| Small clad wall apartment house     | 15,000 ft <sup>2</sup><br>18 apartment units, 3 stories | Prefabricated masonry panels attached to metal frames | Concrete slab                             | Metal frame, double hung                 |
| Small clad wall commercial building | 15,000 ft <sup>2</sup><br>3 stories                     | Wood frame with wood or brick siding                  | Flat wooden roof                          | Wood frame, double hung                  |
| Small masonry commercial building   | 15,000 ft <sup>2</sup><br>3 stories                     | Brick or stone bearing wall                           | Concrete slab                             | Metal frame, double hung                 |
| Small clad wall commercial building | 15,000 ft <sup>2</sup><br>3 stories                     | Prefabricated masonry panels attached to metal frames | Concrete slab                             | Metal frame, commercial casement windows |
| Large masonry commercial building   | 100,000 ft <sup>2</sup><br>8 stories                    | Brick or stone bearing wall                           | Concrete slab                             | Metal frame, double hung                 |
| Large clad wall commercial building | 100,000 ft <sup>2</sup><br>8 stories                    | Prefabricated masonry panels attached to metal frames | Concrete slab                             | Metal frame, commercial casement         |
| Large masonry apartment house       | 100,000 ft <sup>2</sup><br>8 stories, 150 apartments    | Brick or stone bearing wall                           | Concrete slab                             | Metal frame, residential casement        |
| Large masonry clad apartment house  | 100,000 ft <sup>2</sup><br>8 stories, 150 apartments    | Prefabricated masonry panels attached to metal frame  | Concrete slab                             | Metal frame, residential casement        |

SOURCE: Office of Technology Assessment,

**Table 3D.—Assumptions About the Mechanical System Types Used in OTA’s Analysis of Retrofit Cost Effectiveness**  
(see illustrations of mechanical systems in chapter text)

|  |  |
|--|--|
| <p><i>Basic system modeled</i></p> <p><b>Heat</b><br/>Single zone without reheat. Oil-fired burner cycles in response to single thermostat.</p> <p><b>Cooling</b><br/>For small and moderate size buildings a direct expansion (DX) split system. For large buildings a reciprocating chiller making chilled water. Outside air is used for cooling and ventilation only for commercial buildings.</p>   | <p><b>Air systems</b><br/><i>Variations in retrofit options for other systems</i></p> <ul style="list-style-type: none"> <li>• For gas-fired burners. Some retrofits save fewer Btus (vent dampers) because less heat escapes up the flue.</li> <li>• Variable air volume (VAV). Systems without reheat are somewhat more energy efficient. Some retrofits save fewer Btus on VAV systems than on single zone system.</li> </ul>   |
| <p><i>Basic system modeled</i></p> <p><b>Heat</b><br/>Single duct terminal reheat system. Air is circulated to all zones at the temperature required by the zone with the least heat requirements and then heated at zones with higher heat requirements by a terminal coil with hot water or steam from a central oil-fired boiler. Outside air is used to cool the return air (at room temperature) down to temperature required by the zone with the least heat requirement.</p> <p><b>Cooling</b><br/>Air is circulated at the temperature required by the zone with the most cooling requirement and then reheated to meet the temperature requirements of other zones.</p> | <p><b>Complex reheat systems</b><br/><i>Variations in retrofit options for other reheat systems</i></p> <ul style="list-style-type: none"> <li>• For gas-fired boilers. No difference in retrofit cost effectiveness except that resulting from lower fuel cost.</li> <li>• Dual-duct systems. Hot and cool air are carried in different ducts and duct insulation might be more effective.</li> <li>• Multizone and variable air volume (VAV). Are more efficient. Thus, the same retrofits to these systems would be somewhat less cost effective.</li> <li>• Terminal reheat provided by electric resistance heater. Converting to variable air volume would be even more cost effective.</li> </ul>  |
| <p><i>Basic system modeled</i></p> <p><b>Heat</b><br/>Single zone hot-water baseboard radiation with single water temperature set-point. Boiler cycles in response to single space thermostat and circulation pump responds to system water temperature.</p> <p><b>Cooling</b><br/>Window or wall air conditioners controlled room-by-room (coefficient of performance 1.8).</p>   | <p><b>Water/steam systems</b><br/><i>Variations in retrofit options for other systems</i></p> <ul style="list-style-type: none"> <li>• Systems with steam radiators. Pipe insulation would be more important for the higher temperatures. A steam pressure reset would be used instead of a modulating aquastat to relate temperatures inside the boiler to those outside (hotter temperatures inside for colder temperatures outside).</li> <li>• Two-pipe fan coil and induction systems. Use various methods to heat air in each zone from the centrally-heated water or steam. If each zone has a thermostat multizone setback thermostats may be appropriate.</li> <li>• Four-pipe fan coil and induction systems. Circulate centrally-chilled water as well as hot water or steam. The heating retrofits identified by Office of Technology Assessment would apply to the heating system.</li> </ul> |
| <p><i>Basic system modeled</i></p> <p><b>Heat</b><br/>Electric resistance baseboard radiation which cycles in response to room thermostats,</p> <p><b>Cooling</b><br/>Window or wall air conditioners (coefficient of performance 1.8).</p>  | <p><b>Decentralized systems</b><br/><i>Variations in retrofit options for other systems</i></p> <ul style="list-style-type: none"> <li>• Systems with all-electric wall units providing heating and cooling. Retrofits will be the same in cost effectiveness for a combination window unit with the same coefficient of performance as the room air conditioner. If the wall unit takes in a large amount of outside air retrofits will be more cost effective.</li> <li>• Gas space heaters. No difference in building envelope retrofits except for that resulting from lower fuel cost. A retrofit to improve the efficiency of the space heaters (e.g., by installing high-efficiency room-sized pulse boilers) would substitute for retrofits to improve the efficiency of electrical systems.</li> </ul>  |

## Chapter 4

# Will Building Owners Invest in the Energy Efficiency of City Buildings?

## Contents

|   | Page       |  | Page       |
|---|------------|--|------------|
| introduction . . . . .  | 99         | <b>Potential for Increasing the Rate of Retrofit by Building Owners. . . . .</b> | <b>127</b> |
| Context for Building Owner Decisionmaking in <b>1980-81</b> ..... | <b>101</b> | <b>Information: Diminishing the Risks of Retrofit . . . . .</b>                  | <b>132</b> |
| Who Owns What?. . . . .   | 104        | <b>Impact of Less Costly Financing on the Pace of Retrofit. . . . .</b>          | <b>133</b> |
| Impact of Ownership on Building Retrofit. .                       | 107        |  |            |
| Impact of Building Types on the Likelihood of Retrofit. . . . .   | 116        |  |            |
| Likelihood of Retrofit in Multifamily Buildings . . . . .         | 117        |  |            |
| Likelihood of Retrofit in Commercial Buildings . . . . .          | 121        |  |            |
| Potential for Retrofit in Marginal Neighborhoods . . . . .        | 126        |  |            |

| LIST OF TABLES  |             |
|---|-------------|
| <i>Table No.</i>  | <i>Page</i> |
| 27. Likelihood of Retrofit by Building Type and Owner Type. . . . . | <b>100</b>  |
| <b>28. Types of Building Owners Interviewed.</b>                    | 101         |
| 29. Building Types Covered in Building Owner Interviews. . . . .    | <b>101</b>  |

| <i>Table No.</i>  | <i>Page</i> |
|---|-------------|
| 30. Energy's Share of Operating Costs. . . . .  | 162         |
| 31. Ownership Types Believed To Be Most<br>Characteristic of Various Building Types   | 105         |
| 32. Ownership of Office Buildings—<br>Atlanta, 1974, . . . . .  | 105         |
| 33. Holders of Residential and Commercial<br>Mortgages. . . . .   | 106         |
| 34. Retrofit Payback Criteria, Holding<br>Periods, and Access to Financing and<br>Advice Among Different Types of<br>Owners . . . . . | 109         |
| 35. Annual Heating Fuel Costs in<br>Apartment Buildings. . . . .  | 118         |
| 36. National Distribution of Metering<br>Types of Rental Units . . . . .  | 119         |
| 37. Landlords' Ranking of Reasons for<br>Disinvestment. . . . .   | \$126       |
| 38. Thirteen Types of Buildings With<br>Significantly Different Retrofit Options.   | 128         |
| 39. Typology of Small Multifamily<br>Buildings According to the Likelihood<br>of Major Improvement in Energy<br>Efficiency . . . . .  | 128         |
| 40. Typology of Large Multifamily<br>Buildings According to the Likelihood<br>of Major improvement in Energy<br>Efficiency . . . . .  | 129         |
| 41. Typology of Small Commercial<br>Buildings According to the Likelihood<br>of Major Improvement in Energy<br>Efficiency. . . . .    | 130         |
| 42. Typology of Large Commercial<br>Buildings According to the Likelihood<br>of Major Improvement in Energy<br>Efficiency . . . . .   | 131         |
| 43. Percentage of Apartment Building<br>Owners Who Perceived Measures They<br>Installed To Be Effective. . . . .                      | 132         |
| 44. Impact of uncertainty on Expected<br>Annual Energy Savings From a<br>Retrofit Costing \$10,000. . . . .                           | 133         |

| <i>Table No.</i>  | <i>Page</i> |
|---|-------------|
| 45. Building Owner Preferences for Tax<br>Credits or Financing Subsidies. . . . . | 139         |

**LIST OF FIGURES**

| <i>Figure No.</i>   | <i>Page</i> |
|---|-------------|
| 34. Comparison of Prices of Natural Gas<br>and the Prime Rate, 1970-81 . . . . .  | 103         |
| 35. Frequency of Major and Minor Energy<br>Retrofit Among Building Owners<br>Interviewed . . . . .  | 108         |
| 36. Frequency of Retrofits Among Building<br>Types Covered in Building Owner<br>Interviews. . . . .   | 116         |
| 37. Apartment Operating Revenues and<br>Expenses, 1970-76. . . . .  | 118         |
| 38. Combinations of Loan Terms and Interest<br>Rates Which Allow the Value of Energy<br>Savings to Exceed the Cost of Borrowed<br>Money the First Year. . . . . | 134         |
| 39. Cash From Operations for an 18-Unit<br>Apartment Building With and Without<br>an Energy Retrofit. . . . .   | 136         |
| 40. impact of Energy Retrofit Subsidies on<br>Pretax and Aftertax Cash Flow for a<br>Prototypical Apartment Building. . . . .                                   | 137         |
| 41* Impact of a Retrofit on Pretax and<br>Aftertax Cash Flow for Two other<br>Prototypical Apartment Buildings. . . . .   | 138         |

**BOXES**

|   | <i>Page</i> |
|---|-------------|
| C. Permanent Financing: Roles of<br>Mortgage Banks and Insurance<br>Companies . . . . . | 106         |
| D. Corporations: Taxes and Accounting. . . . .  | 106         |
| E. A Question of Value: How the Appraiser<br>Sees It. . . . .                           | 113         |
| F. Role of the Property Manager. . . . .  | 113         |

# Will Building Owners Invest in the Energy Efficiency of City Buildings?

---

## INTRODUCTION

Virtually all types of city buildings (as is clear from ch. 3) can be retrofit to save a substantial portion of their energy. Some can be retrofit easily and cheaply. Others can be retrofit only with difficulty and at considerable expense but nonetheless in such a way that the expense would be justified by energy savings over the building's lifetime.

The question remains, however, will these buildings be retrofit? The answer given by this chapter is that city buildings will not be retrofit unless several more conditions are met beyond the fact that the building is cost effective to retrofit.

If a building that can be retrofitted is to be retrofitted three additional conditions must be met:

- the building's energy inefficiency must cause a noticeable loss in present or future return from the building,
- an investment in improved energy efficiency is consistent with the building owner's goals, and
- the building owner has the means—adequate information, decisionmaking ability, time, and financial resources—to make the investment.

Furthermore, even if the building owner is willing and able to make such an investment, it will not happen unless there are businesses ready to recommend and install the retrofit. The state of the energy retrofit business is mentioned briefly in this chapter but is discussed more completely in chapter 7.

For example, it should be easy (given the analysis in ch. 3) to prescribe a set of very cost-effective retrofits for a small frame multifamily building with an old inefficient steam system in a city with a cold climate. Yet for the identical building with identical retrofit potential the chances

of retrofit range from good if it is an owner-occupied building in an up-and-coming neighborhood to *very poor* if it is owned by an absentee landlord, and is located in a declining neighborhood.

A curtain wall office building with a decentralized heating system of electric baseboard heat and window air conditioners has much poorer prospects for inexpensive easy retrofit than the small frame steam-heated building. In most cases, only expensive retrofits are available for such a building, replacing the electric resistance heaters with heat pumps or installing double glazed window panels. Nonetheless, because of the potential goals of its owners and their resources the chances that such a building will actually be retrofit range from good for a corporate headquarters or office building owned by an insurance company or pension fund to *poor* if it is owned by a small local partnership for tax shelter purposes.

The likelihood that a building will be retrofit depends both on its type of owner and on the importance of energy costs for the purpose the owner uses the building for. Table 27 illustrates in a schematic way the general prospects for retrofit for different combinations of buildings and owners. In general, the chances that a building will be retrofit are less likely for multifamily than for commercial buildings, less likely for buildings owned for investment than for buildings occupied by their owners, and less likely for buildings owned by individual owners or local partnerships than for those owned by institutional owners such as pension funds and insurance companies, or national partnership syndicates.

In fact real estate is not quite so simple as table 27. The rest of the chapter explains some of the complexity of investment for energy efficiency in buildings. To date little specific research work has been done on the subject of

**Table 27.—Likelihood of Retrofit by Building Type and Owner Type**

|                       |   | Decreasing likelihood |       |        |                            |                            |
|-----------------------|---|-----------------------|-------|--------|----------------------------|----------------------------|
|                       | Owner-occupants                             | Office                | Hotel | Retail | Multifamily master-metered | Multifamily tenant-metered |
| Decreasing Likelihood | Corporation . . . . .                       | L                     | L     | L      | x                          | x                          |
|                       | Individual . . . . .                        | M                     | M     | M      | M                          | P                          |
|                       | Condominium. . . . .                        | X                     | x     | x      | M                          | M                          |
| investor-owners       |   |                       |       |        |                            |                            |
| Decreasing Likelihood | Institutional (pension, insurance). . . . . | L                     | L     | L      | L                          | M                          |
|                       | Development company . . . . .               | M                     | M     | P      | P                          | u                          |
|                       | National partnership . . . . .              | M                     | M     | M      | M                          | P                          |
|                       | Local partnership. . . . .                  | P                     | P     | P      | P                          | u                          |
|                       | Individual . . . . .                        | P                     | P     | u      | P                          | u                          |

L = Likely.  
 M = Moderate.  
 P = Possible.  
 U = Unlikely.  
 X = There are none or very few examples of such building types owned by these owners.  
 SOURCE: Office of Technology Assessment

the motivation to invest in energy efficiency per se although there is voluminous literature on investment in real estate.<sup>1</sup>The chapter relies heavily on work done for OTA by the Real Estate Research Corp. (RERC) a Chicago-based consulting firm specializing in the investment analysis of real estate and in appraisal.

RERC conducted a comprehensive literature review, and interviewed buildings owners in four case study cities (Buffalo, N.Y., Des Moines, Iowa, Tampa, Fla., and San Antonio, Tex.) as well as “national” real estate owners with holdings in all parts of the country. RERC also analyzed prototype multifamily buildings to evaluate the impact of rising energy costs and energy retrofits financed in several alternative ways. In total, RERC talked to 96 building owners representing different types of owners and different building uses. (The breakdown of interviews is shown in tables 28 and 29.) These

<sup>1</sup>Several other useful sources on real estate decisions and energy conservation include: Hittman Associates, *Physical Characteristics, Energy Consumption and Related Institutional Factors in the Commercial Sector*, DOE report, February 1977; *Proceedings of the Multifamily and Rental Housing Workshop*, Dec. 4, 5, and 6, 1980, Washington, D. C., sponsored by the Federation of American Scientists Fund prepared by Deborah L. Blevis; Alice Levine, and Jonathan Raab, *Solar Energy, Conservation and Rental Housing*, Solar Energy Research Institute, March 1981; *Multi-Family Energy Conservation: A Reader*, Coalition of Northeast Municipalities, July 1981.

interviews, supplemented by extensive reading in real estate trade literature, in-house RERC expertise, and OTA staff research form the basis for this chapter.

This chapter focuses on privately owned, urban commercial, and multifamily buildings—offices, retail facilities, hotels, and small, medium, and large apartment houses—partly because these form the bulk of the urban building stock and partly because these have been woefully neglected in the literature on investment in energy efficiency. The chapter does not specifically address the motivation for investment by owners of single-family houses. This subject was fully covered in the previous OTA study on Residential Energy Conservation, and other literature,<sup>2</sup>and is addressed to some extent in other chapters of this report Chapter 5, *Retrofit for the Housing Stock of the Urban Poor* and Chapter 9, *The Public Sector Role in Urban Building Energy Conservation*. Under some conditions the motivation of single-family home owners parallels that of the owner-occupants of small multifamily buildings and this will be pointed out in the text.

<sup>2</sup>A comprehensive analysis of the potential for energy conservation in single-family houses are the final report and working papers of the *Residential Energy Efficiency Standards Study* submitted to Congress by the Department of Housing and Urban Development in July 1980.



**Table 28.—Types of Building Owners Interviewed<sup>a</sup>**

| Owner status                  | Buffalo   | Des Moines | Tampa     | San Antonio | National  |
|-------------------------------|-----------|------------|-----------|-------------|-----------|
| Individual . . . . .          | 8         | 4          | 1         | 3           | 6         |
| Partnership . . . . .         | 7         | 5          | 4         | 4           | 5         |
| Corporate . . . . .           | 3         | 4          | 1         | 2           | 4         |
| Institutional . . . . .       | 0         | 1          | 0         | 0           | 10        |
| Development company . . . . . | 3         | 0          | 0         | 1           | 4         |
| Bank . . . . .                | 4         | 2          | 4         | 3           | —         |
| Condominium . . . . .         | 0         | 0          | 1         | 1           | 1         |
| <b>Total . . . . .</b>        | <b>25</b> | <b>16</b>  | <b>11</b> | <b>14</b>   | <b>30</b> |

<sup>a</sup>Some owners interviewed had multiple ownership positions (e.g., as individual owners and members of partnerships). Owners were tabulated on the basis of their principal ownership role.

SOURCE: Real Estate Research Corp.

**Table 29.—Building Types Covered in Building Owner Interviews**

| Building type          | Buffalo   | Des Moines | Tampa     | San Antonio |
|------------------------|-----------|------------|-----------|-------------|
| Multifamily . . . . .  | 10        | 9          | 3         | 7           |
| Retail . . . . .       | 2         | 3          | 3         | 2           |
| Shopping centers       |           |            |           |             |
| Department stores      |           |            |           |             |
| Retail strip           |           |            |           |             |
| Offices . . . . .      | 8         | 6          | 4         | 6           |
| Hotels . . . . .       | 1         | 1          | 0         | 2           |
| <b>Total . . . . .</b> | <b>21</b> | <b>19</b>  | <b>17</b> | <b>10</b>   |

NOTE: The number of building types will not exactly correspond to the number of owner types due to multiple ownership and the fact that banks were not interviewed as owners in all cases.

SOURCE: Real Estate Research Corp.

The decision to make energy improvements in response to rapidly rising energy costs is above all a real estate investment decision. Like other real estate decisions it is affected by overall investment strategy, tax laws, marketability of the property, lease terms, cost and availability of financing, perception of risk, and many other considerations for a particular building. Furthermore, real estate is a complex and diverse industry. Markets vary sharply from city to city and even from neighborhood to neighborhood. Ownership runs the full range from the giant corporation that owns its own

headquarters building to the retired couple holding onto their small three-story walkup as their nest egg. The conditions under which real estate decisions are made can change drastically from year to year. The rapid increases in inflation and interest rates of the last few years have had profound consequences for decisions made by all kinds of real estate owners. (More recently, the 1981 tax law has made sweeping changes in the importance of real estate as a tax shelter for other income.) The chapter treats each of these influences on a building's prospects for retrofit.

## CONTEXT FOR BUILDING OWNER DECISIONMAKING IN 1980-81

Although the general goals of investment in real estate remain the same over years and decades, the specific concerns of building owners are significantly influenced by the structure of costs and opportunities in a particular place and time. The year 1980, when most of the survey

work was done, had its particular features, many of which continued into 1981.

Energy is Now Important. First of all, after many years of energy price increases, energy began to be, for many building owners, a seri-

ous concern in 1980. It was widely perceived, as reported to RERC, as having crossed a threshold of importance within the overall balance of income and expense for particular buildings. In its annual national survey *Emerging Trends in Real Estate 1981*, RERC described this change in consciousness of energy by building owners:<sup>3</sup>

In 1979, their attitude was that increased costs would simply be passed on to consumers; but this year's comments are less cavalier. Lenders are examining the energy efficiency of buildings being purchased or developed; investors are concerned about absolute operating costs, and not just those they will pay themselves; and tenants are seriously evaluating energy costs when considering space alternatives.

Although some of the building owners interviewed for OTA did not share this perception, most did and echoed the concern of the manager of a downtown office tower in Buffalo: "That electric bill is incentive enough, believe me!"

For most categories of building operations and businesses, the rapid increases in energy prices (described in ch. 2) have been faster than increases in other costs of doing business such as labor or property taxes. For all except hotels (see table 30), the cost of energy was a far

<sup>3</sup>Real Estate Research Corp., "Emerging Trends in Real Estate: 1981," Chicago, Ill., October 1981.

**Table 30.—Energy's Share of Operating Costs  
(in percent)**

|                                     | 1970   | 1975       | 1979    |
|-------------------------------------|--------|------------|---------|
| Downtown office(1) . . . . .        | 18.90% | 19.1%      | 23.80/o |
| Center city hotel (2) . . . . .     | NA     | 7.9        | 7.5     |
| Neighborhood shopping (3) . . . . . | 5.9    | (1972) 4.2 | 9.1     |
| Elevator multifamily (4):           |        |            |         |
| Heating fuel . . . . .              | 5.5    | NA         | 13.4    |
| Electricity . . . . .               | 6.9    | NA         | 13.8    |
| Gas . . . . .                       | 1.3    | NA         | 2.7     |
| Low-rise (12-24 units) (4):         |        |            |         |
| Heating fuel . . . . .              | 13.1   | NA         | 18.9    |
| Electricity . . . . .               | 2.8    | NA         | 8.9     |
| Gas . . . . .                       | 1.3    | NA         | 2.7     |

NA = Not available.

SOURCES: 1980, 1976, 1971, *Downtown Office Experience Exchange Report*, Building Owners and Managers Association (BOMA), Washington, D.C.; Laventhol and Horwath, U.S. Lodging Industry, 1976, 1979, 1980 reports; *Dollars and Cents of Shopping Centers, 1972, 1975, 1978* ULI — The Urban Land Institute, Washington, D. C.; *Income/Expense Analysis: Apartments*, Institute of Real Estate Management (1950 and 1975 editions). All figures are national averages.

greater share of costs in 1979 than it was in the early 1970's. (**Vigorous conservation by hotels appears to be responsible for holding the energy share down.**) Further rapid increases in energy prices since 1979, especially in heating oil, help account for the obvious concern about energy which was evident in the interviews with building owners in late 1980.

**The energy retrofit business** scarcely existed a few years ago, and is still in the process of getting organized in response to the increasing interest in controlling energy costs. A few long-established companies offer specialized energy retrofits such as energy control systems. Many other companies already expert in the installation and maintenance of heating, ventilating, and air-conditioning systems are acquiring experience and are recommending and installing energy retrofit measures. There are still only a few general retrofit companies that have both experience with mechanical systems and experience with such envelope retrofits as double glazing, blockage of air infiltration or insulation. The current embryonic state of the private market ability to prescribe and install retrofits is described in more detail in chapters 3 and 7. Nonetheless, observers of this process believe that it will take a few more years for enough businesses to acquire solid reputations in this field, so that the building owners' interest that is now manifest will be matched by a private market response.

The current state of knowledge about the demonstrated effects of retrofit on energy use is as embryonic as the energy retrofit business. Although proprietary information is now being developed on retrofit results for such businesses as restaurant chains and department stores, there is still very little published information, in a few years there should be more publicly available information on actual retrofits from surveys, from demonstration projects and from such programs as the federally funded program to retrofit schools and hospitals. Improved knowledge of retrofit results, coupled with longer track records of the now-forming energy retrofit companies will reduce the element of uncertainty that still looms large in any decision to invest in building energy efficiency.

**Leasing Trends.** Offsetting increasing owner concern with energy costs, is an increasing tendency for leases to be written so as to pass all or most energy costs to the tenants. The different types of leases and their implications for energy use are described below in sections on each building type. In multifamily buildings owners are converting master-metered buildings to tenant metering if technically feasible and introducing prorata billing systems for energy costs when it is not technically feasible. In office buildings new leases are written with passthrough clauses in a variety of forms. In the last decade, retail buildings (especially shopping centers) have almost entirely converted from gross to net leases in which not only energy costs, but maintenance and cleaning costs, taxes, and a prorata share of the common space are passed on to tenants.

Net leases, and passthrough leases encourage tenant responsibility for sensible use of energy in their rented space. Although little has been documented of the impact of these types of leases on energy use in commercial space, one

estimate of the energy savings from tenant metering in multifamily buildings is 5 percent for heating costs (more for electric heat, less for gas) and 20 percent for other energy costs.<sup>4</sup> However, for those buildings for which substantial investments in energy retrofits such as new lighting systems or more efficient central boilers would increase their energy efficiency, the prevalence of net and passthrough leases clearly reduces the immediate incentive of the owner to invest.

Over the longer term the owner of a building with net leases may still invest in its energy efficiency but will take into account the competitive importance of an energy efficient building to his tenants in the overall market that they operate in. The variations among office, hotel, retail, and multifamily tenants in their concerns about the energy efficiency of their buildings will be described below.

<sup>4</sup>Lou McLelland, "Encouraging Energy Conservation in Multifamily Housing: RUBS and Other Methods of Allocating Energy Costs to Residents," Executive Summary, 1980, *Institute of Behavioral Science*, University of Colorado, p. 8.

**Figure 34.—Comparison of Prices of Natural Gas and the Prime Rate, 1970-81**

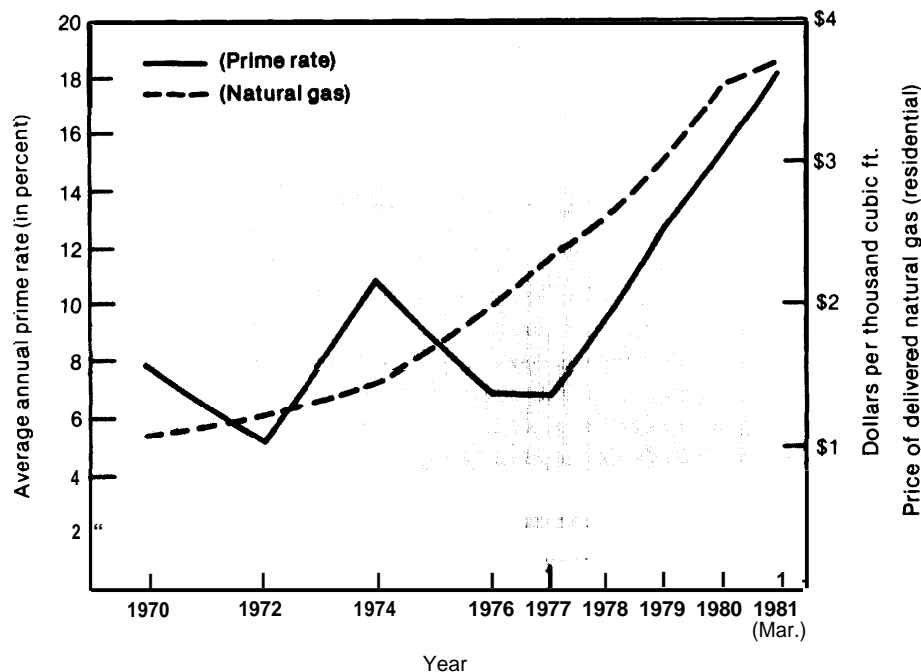

SOURCE: Federal Reserve Board; Department of Energy, Energy Information Administration, *Annual Report to Congress*, 1980, p. 119, *Monthly Energy Review*, August 1981, p. 16.

**Costs of Financing.** Energy isn't the only cost of doing business that has increased in the past few years. Since 1977, the cost of financing—for buildings, equipment, inventories, and energy retrofits—has increased just as fast. Since 1970 (as can be seen in fig. 34), the prime rate is seen to increase as fast as the price of natural gas. Most energy retrofits substitute capital for energy. The high cost of financing has been a serious disincentive to retrofits.

Traditionally, major building improvements including energy retrofits were financed by refinancing (remortgaging) the entire building. Alternatively, second mortgages might be used at premium, but not prohibitive, rates. In the current climate neither is practical. Refinancing a fixed rate mortgage issued 5 years ago at 9 percent with a note of 14 to 17 percent or higher is neither sensible nor affordable. Furthermore, in response to persistent high inflation, most financial institutions are moving away from fixed rate, long-term mortgage loans, which in late 1980 were virtually unavailable. Instead they are developing 5-year renegotiable mortgages, variable rate financing methods and equity participation. As a banker interviewed in Tampa put it: "This last round of madness in money markets has destroyed the conventional means of financing income property. Now they say 'give me a piece of it'."

Some shorter term alternatives to refinancing and second mortgages for building improvements—such as commercial bank loans, lines of credit, signature loans or borrowing against personal assets—are generally available at the same interest rate as construction loans, floating 2 points over prime (21 percent in both the summer of 1980 and spring of 1981). To be sure, banks may lend below prime to preferred customers but these generally must maintain large deposits in exchange for preferred treatment on loans. At such high financing rates, virtually all building owners will postpone building improvements including energy retrofits unless they can be financed internally (see the later discussion of the availability of internal funds).

**Overall Context.** To sum up, the year 1980-81 finds several contradictory influences on the likelihood of energy retrofit investment in buildings. Building owners' newly recognized concerns about energy costs, the gradual improvement in the organization of the energy retrofit business, and the knowledge of the impact of energy retrofit all tend to increase the amount of retrofit that is likely to occur. Strongly offsetting these influences, however, is the growing tendency toward net and passthrough leases and the very high cost of financing.

## WHO OWNS WHAT?

The prospects for energy retrofit to a particular building depend on both what a building is used for and who owns it. Although all kinds of buildings, large and small, commercial and residential, are owned by individuals or local partnerships, other organizations active in real estate, such as insurance companies or national partnership syndicates, tend to specialize in only a few building types. Before proceeding to a discussion of the impact of owner types, or building types on retrofit, it is important to know who owns what.

Most of what is known about ownership of buildings is known from real estate trade litera-

ture and the expertise of real estate analysts and operators. There is virtually no detailed data on ownership. In some States such as Illinois, moreover, ownership is hidden by various devices permissible under State law. In only a few cities for a few particular markets, office buildings, multifamily, etc., have there been surveys of types of owners.

The consensus of conventional wisdom in real estate on who owns what is shown in table 31. Small buildings are usually owned by individuals and partnerships, and small business corporations. Large buildings may be owned by individuals and partnerships as well, but may

**Table 31.—Ownership Types Believed To Be Most Characteristic of Various Building Types**

|   | Owner-occupants |                              |             |               | Investor-owners      |                     |                   |            |
|---|-----------------|------------------------------|-------------|---------------|----------------------|---------------------|-------------------|------------|
|   | Corporation     | individual or small business | Condominium | Institutional | National partnership | Development company | Local partnership | Individual |
| <b>Small buildings:</b>                           |                 |                              |             |               |                      |                     |                   |            |
| <b>Multifamily (2-9 units)</b> . . . . .          |                 | x                            |             |               |                      |                     | x                 | x          |
| <b>Office buildings</b> . . . . .                 |                 | x                            |             |               |                      |                     | x                 | x          |
| <b>Retail strip stores</b> . . . . .              |                 | x                            |             |               |                      |                     | x                 | x          |
| <b>Large buildings:</b>                           |                 |                              |             |               |                      |                     |                   |            |
| <b>Multifamily</b> (more than 10 units) . . . . . |                 |                              | X           | X             | X                    |                     | X                 | X          |
| Office buildings . . . . .                        | X               |                              |             | X             | X                    | X                   | X                 | X          |
| Shopping centers . . . . .                        |                 |                              |             | X             | X                    | X                   | X                 |            |
| Department stores . . . . .                       | X               |                              |             |               |                      |                     | x                 | x          |
| Hotels . . . . .                                  | X               |                              |             |               | x                    | x                   | x                 |            |

SOURCE: Office of Technology Assessment

also be owned by insurance companies, pension funds, major corporations, national partnership syndicates, or development companies.

Partnerships are believed to be the most common form of real estate ownership, because of the real estate tax advantages a partnership has over a corporation. In a survey of office buildings in the city of Atlanta (table 32), partnerships and corporations were not distinguished. If, however, partnerships were the bulk of the owners, as predicted by conventional wisdom, then they accounted for more than half of all office buildings in the city.

**Table 32.—Ownership of Office Buildings—Atlanta, 1974**

| Type of ownership                       | Number of buildings |
|---|---------------------|
| Corporations and partnerships . . . . . | 216                 |
| Savings and loans . . . . .             | 19                  |
| Banks . . . . .                         | 17                  |
| Individuals . . . . .                   | <b>50</b>           |
| Labor unions . . . . .                  | 3                   |
| Real estate companies . . . . .         | 13                  |
| Insurance . . . . .                     | 26                  |
| Real estate investment trusts . . . . . | 3                   |
| Nonprofit organizations . . . . .       | 8                   |
| Uncertifiable . . . . .                 | 8                   |
| <b>Total</b> . . . . .                  | <b>363</b>          |

NOTE: Survey included urban structures of at least 10,000 ft<sup>2</sup> and suburban structures of at least 30,000 ft<sup>2</sup>, all within the vicinity limits.

SOURCE: *Commercial Space Policy Analysis of Profitability of Retrofit of Energy* Conserve/err, Metro Study Corp., Washington, D.C., June 1976

Although local partnerships are still the dominant form of partnership in real estate, national *syndicates of partnerships* (such as JMB, Robert MacNeil, and Balcor) have become increasingly important in the last half decade. They are listed with the Securities and Exchange Commission and their sales are handled by such brokerage firms as Merrill Lynch and E. F. Hutton. National syndicates select their investments with an eye to future appreciation. A few (such as Robert MacNeil) specialize in multifamily properties; others favor the generally higher returns from owning and leasing office buildings, shopping centers, and hotels.

*Development companies*, when they own real estate as well as build and develop it, also prefer office buildings, shopping centers, and hotels and tend to avoid the smaller returns of smaller commercial buildings and multifamily buildings. So do the increasingly important *institutional* investors such as insurance companies, and *pension funds*. These latter have traditionally provided the permanent financing for larger multifamily and commercial buildings, generally through the brokerage of a mortgage bank (see box C). Increasingly, however, these institutions are becoming more active in the equity ownership of buildings themselves. For pension funds, recent changes in the Employment Retirement and Security Act (ERISA) have permitted a more aggressive direct role in real

**Box C.—Permanent Financing: Roles of Mortgage Banks and Insurance Companies**

In real estate, long-term or "permanent" financing by institutions has been generally performed by insurance companies for non-residential properties and large apartment properties, while banks have mortgaged single-family residential properties. Commercial banks, in part because of Federal restrictions on their loan/assets ratio, have not been long-term lenders, but have targeted their real estate loans to development companies through short-term construction loans or as interim financing until the project finds a permanent lender.

The current volatility and change in real estate financing methods and sources makes these traditionally discrete roles much less certain. And, Federal deregulation of banking—particularly savings and loans—may have a profound effect on the future sources of real estate financing.

One group of the real estate "actors" likely to be affected are mortgage bankers, who have traditionally operated as middlemen between financiers and developers. Mortgage bankers originate, sell, and service mortgage loans, both conventional and subordinated, to institutional investors. Acting as an intermediary, the mortgage banker brings the parties together, often helps produce a financing package and helps negotiate the loan. After selling the loan—typically, to life insurance companies and savings banks—the mortgage banker later services the loans. He generally collects both origination and servicing fees that comprise the bases of his return. With the entry of institutional investors and pension funds now setting up their own direct lending arms, mortgage banking may have to adjust its services to mesh with this trend.

Table 10.—Mortgage Bankers and Insurance Companies

| Year | Assets | Liabilities | Equity |
|------|--------|-------------|--------|
| 1970 | \$10.0 | \$10.0      | \$0.0  |
| 1971 | \$10.5 | \$10.5      | \$0.0  |
| 1972 | \$11.0 | \$11.0      | \$0.0  |
| 1973 | \$11.5 | \$11.5      | \$0.0  |
| 1974 | \$12.0 | \$12.0      | \$0.0  |
| 1975 | \$12.5 | \$12.5      | \$0.0  |
| 1976 | \$13.0 | \$13.0      | \$0.0  |
| 1977 | \$13.5 | \$13.5      | \$0.0  |
| 1978 | \$14.0 | \$14.0      | \$0.0  |
| 1979 | \$14.5 | \$14.5      | \$0.0  |

Source: J. P. ... The Real Estate Handbook, New York: ... 1980, page 100.

estate. As of 1979, the eight biggest life insurance companies had about \$3.8 billion in real estate purchases, joint ventures and income property construction, out of total assets of \$215 billion including about \$64 billion in mortgages.<sup>5</sup> Institutions are a small but increasing share of building owners.

Corporations tend to own buildings for their own use partly because corporate tax laws discourage the use of building losses to shelter other income (see box D). They commonly own office buildings, hotels, and department stores, more rarely shopping centers and almost never apartment buildings.

As a group, the owners of multifamily buildings are the smallest and least organized of all owners. About 2.7 million owners occupy one or more apartments of multifamily building they own.<sup>6</sup> The Urban Institute found in a 1976

<sup>5</sup>Crittenden Financing, Inc., 1980.  
<sup>6</sup>U. S. Bureau of the Census, General Housing Characteristics, U.S. and Regions 1977, 1978.

**Box D.—Corporations: Taxes and Accounting**

Corporations are inhibited from owning real estate for investment purposes because of several characteristics of their tax and accounting requirements. Unlike real estate partnerships that can operate as tax shelters for unrelated income, corporations cannot pass on tax losses from real estate depreciation and interest deductions to shareholders to shelter shareholders' income from other sources. Corporations also find it more difficult than partnerships to pass on cash flow profits from real estate since profits are taxed twice, once as corporate income and again as shareholder dividends. Finally, accounting standards for corporations require that all debt be shown on the balance sheet and that the asset value of real estate be recorded as "original cost less depreciation." Due to these accounting rules, real estate investment may not be as attractive as it appears. The tax rate of corporations without property allowances is higher than the rate of the individual investor. Many corporations have sold their ownership of nonresidential real estate over the last decade.

study of Boston that 60 to 70 percent of the multifamily buildings were owned by individuals who owned less than 30 units. Only 10 to 15 percent held buildings with 150 units or more. These findings are consistent with findings from Baltimore and Newark.<sup>7</sup>

*Condominium* ownership of multifamily units has not yet made a large dent in the overall rental market but has become significant in a few cities where escalating property values encourage conversion. According to a 1979 Department of Housing and Urban Development (HUD) study, only 1.3 percent of all rental units had been converted to condominiums from 1970-79. In Washington, D. C., however, 6.8 percent had been converted and in Denver and Boulder, Colo., 8.8 percent. In such cities as New York where cooperative apartments are traditional, there was a large number of conversions to cooperatives, rather than to condominiums.<sup>8</sup>

<sup>7</sup>Larry Ozanne and Ray Struyk, *Housing From the Existing Stock*, The Urban Institute, 1976, pp. 107-108. The information was obtained by Struyk from interviews with large property managers in Boston. Results from Newark are reported in George Sternlieb, *The Tenement Landlord*, Rutgers University Press, 1966, and results from Baltimore are reported in Michael Stegman, *Housing Investment in the Inner City*, MIT Press, 1972.

<sup>8</sup>Department of Housing and Urban Development, *The Conversion of Rental Housing to Condominiums and Cooperatives: A National Study of Scope, Causes and Impact*, 1980.

Many commercial buildings are small and occupied by their small business owners, who may be individuals, partners, or small corporations. Based on information in a recently published Energy Information Administration survey of commercial buildings, as many as 60 percent of the smallest buildings of up to 5,000 ft<sup>2</sup> are likely to be occupied by their owners.<sup>9</sup>

The structure of ownership is significant for the prospects for energy retrofit. In general, as is explained in the next section, the largest, most financially independent and best advised owners (corporations, national partnership syndicates, development companies, insurance companies, and pension funds) tend to own the large commercial buildings. The smaller and least organized owners tend to own multifamily buildings.

<sup>9</sup>Energy Information Administration, *Non-Residential Buildings Energy Consumption Survey*, 1981, table 23 B. It is harder to be precise about larger buildings because EIA asked if buildings were occupied by the owner or his agent. Since larger buildings may be occupied by a manager agent of the owner, they are not truly owner-occupied.

## IMPACT OF OWNERSHIP ON BUILDING RETROFIT

Among the types of owners interviewed, there were striking differences in the extent to which they had made major energy investments in some or all of their buildings, minor energy investments (including significant operational improvements), or, no energy investments or operational changes at all. The survey of building owners was not constructed to be a statistically valid sample of building owners and for this reason only tentative and suggestive conclusions can be drawn from the results; nonetheless the pattern of retrofits reported by the different types of building owners is consistent with

what they said about their motivation and resources to carry out a retrofit.

The retrofit experience of the owners interviewed is shown in figure 35. The top level shows the "national" owners with holdings across the country; the bottom level shows the owners interviewed in the four case study cities. The differences among types of owners is striking. Out of 22 interviewed, only one individual owner, of any kind, had made a major energy investment, although 8 had made minor investments. On the other hand, 10 "national" insti-

Figure 35.— Frequency of Major and Minor Energy Retrofit Among Building Owners Interviewed

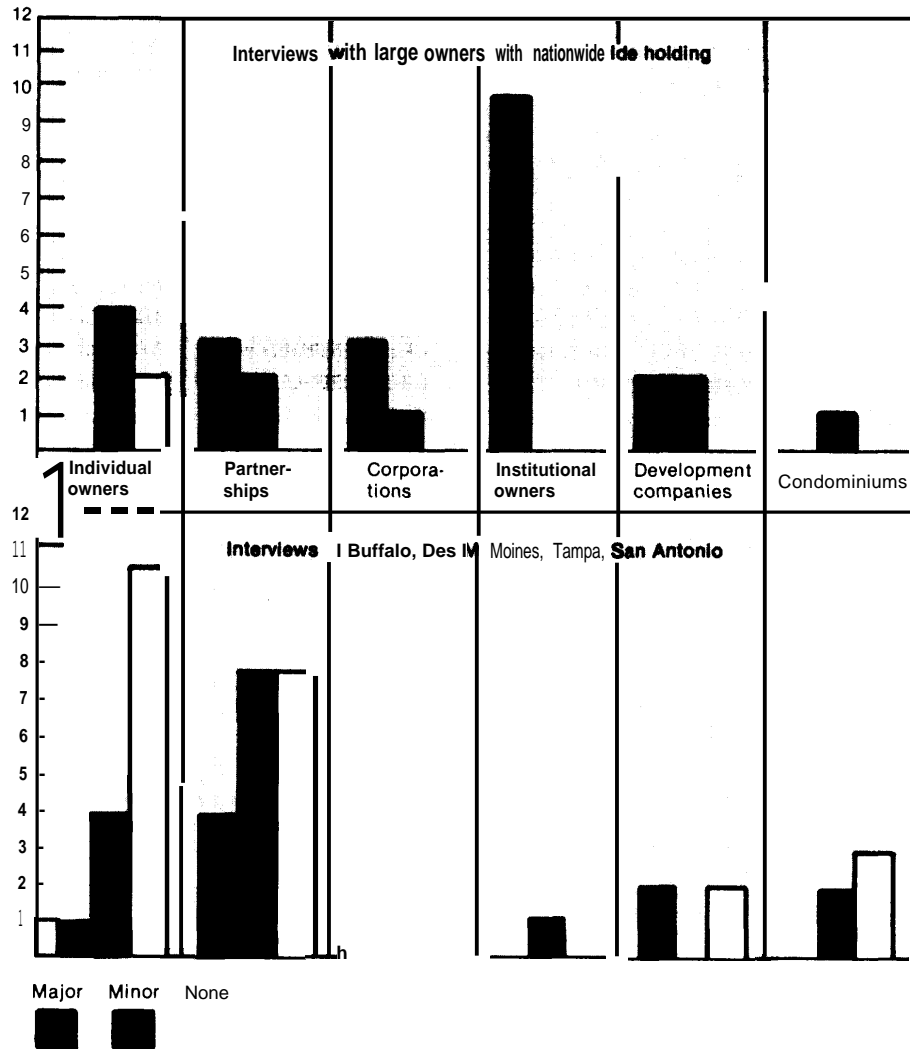

NOTE: Minor energy investments cost little enough that they could be handled as "expenses" and not "capital investments."

SOURCE: Real Estate Research interviews for OTA

tutional owners interviewed had made major energy investments in their buildings. National partnership syndicates, national corporations, and development companies all had either made major or at least minor energy investments.

Significant numbers of the local individual owners and local partnerships had done nothing to their buildings in response to increasing energy prices. Of the four condominium associ-

ations interviewed, none had made major energy investments.

The results of the interviews cannot be compared with any statistically valid survey data because none has been conducted by owner type. The interviews did make clear, however, the thinking that goes into a building owner's decision to retrofit or not retrofit and why it is likely to be different for different types of owners. The rest of this section explains how owners differ in



the motivation to make energy investments in their buildings, and, equally important, in the financial and managerial resources they can call upon to make an investment.

The Differences Among Owners' Payback Criteria for Retrofits. In their interviews, different types of owners were explicit and quite consistent in their criteria for how fast an energy retrofit should "pay back" in energy savings. Almost all owners used simple payback as the criterion, namely how many times would the first year's savings have to be multiplied to equal the cost of the retrofit. Only banks (who were generally not interviewed as building owners, but as financiers) reported using a discount rate, their borrowing cost from Federal funds. Although building owners expected increases in fuel and electricity cost over the payback term and took this into account in a general fashion, most of them cited payback terms so short that fuel escalation would not make a substantial difference.

The payback criteria used by owners, shown in table 34, varied from the fairly long paybacks of 5 to 7 years used by institutional owners to the very short payback requirement of 1 year or less used by individual investor-owners. The longer paybacks would permit more comprehensive retrofits to more buildings such as

burner or boiler replacement, complex energy management systems, full window retrofits, and even replacement of less efficient window air conditioners with more efficient air conditioners (see ch. 3 for a full discussion). A payback requirement of a year or less, on the other hand, eliminates all but operational improvements and small investments such as flow restrictors, clock thermostats, or more efficient light bulbs.

The rest of table 34 helps explain why different types of owners had such varied criteria. Owners with longer payback criteria have longer expected holding periods for their buildings as well as much better access to financing and professional advice. The owners with shorter payback criteria expect to hold their buildings for shorter periods of time and also have problems getting adequate financial or professional advice.

Among owners, there is a major distinction among owner-occupants and investor-owners. For business *owner-occupants* (large corporations and smaller businesses) energy costs are one of the many expenses of doing business. Because these costs are rising so rapidly, they have become a major concern, but cost containment is only one of many possible uses of their available funds. *owner-occupants* hold real estate principally for their own use, though

**Table 34.—Retrofit Payback Criteria, Holding Periods, and Access to Financing and Advice Among Different Types of Owners**

| Building owner type               | Typical payback criteria | Building for own use? | Expected holding period | Access to capital | In house professional advice |
|-----------------------------------|--------------------------|-----------------------|-------------------------|-------------------|------------------------------|
| <b>Owner-occupants:</b>           |                          |                       |                         |                   |                              |
| Large corporations . . . .        | 3-5 yrs.                 | Yes                   | Long                    | Good              | Good                         |
| Small businesses . . . . .        | 1 yr.                    | Yes                   | Long                    | Poor              | Poor                         |
| <b>Multifamily owner</b>          |                          |                       |                         |                   |                              |
| occupants . . . . .               | 1-3 yrs.                 | Yes                   | Long                    | Poor              | Poor                         |
| Condominium . . . . .             | No data                  | Yes                   | Long                    | Mixed             | Fair                         |
| <b>Investor-owners:</b>           |                          |                       |                         |                   |                              |
| <b>Institutional owners . . .</b> |                          |                       |                         |                   |                              |
| Development companies . . . . .   | 5-7 yrs.                 | No                    | Long                    | Good              | Good                         |
| Partnership syndicates . . . . .  | 1-3 yrs.                 | No                    | Short                   | Fair              | Good                         |
| Local partnerships . . . . .      | 3 yrs.                   | No                    | Short                   | Fair              | Good                         |
| Individuals . . . . .             | 1-2 yrs.                 | No                    | Short                   | Poor              | Fair                         |
|                                   | 1 yr.                    | No                    | Mixed                   | Poor              | Poor                         |

NOTE Long holding period = more than 10 years, short holding period = 8-10 years.

SOURCE: Office of Technology Assessment.

tax benefits may be enjoyed and appreciation in real estate value hoped for. Residential owner-occupants who live in one unit of a small apartment building and condominium owners do not use their real estate to conduct a business but share with business owner-occupants the point of view that the primary purpose of the building is for their own use and real estate return is secondary. Investor-owners, on the other hand, are not interested in buildings for their usefulness as buildings but for the many forms of economic return they may obtain from holding them. The rest of this section describes the motivation for energy retrofit of each of the owner-occupants and investor-owners included in table 34.

**Large Corporate Owner Occupants.** Large corporations almost always occupy any buildings that they own. Corporations are inhibited from owning real estate for investment purposes by aspects of corporate tax status that reduce the return to corporations from real estate below what is available to individuals and partnerships (see box D). Thus, the chief economic benefit of corporate buildings is their efficiency

as business facilities and, in some cases, the extent to which they enhance the corporate image.

Corporate owners of their own office facilities or downtown retail stores or hotels reported in interviews that they base energy improvement decisions on expected business return not on real estate return. If energy-efficiency results in lower business operating expenses, greater employee productivity, enhanced attractiveness to patrons or better business image, improvements are likely to be considered in competition with alternative corporate investments in marketing, expansion or inventory control. The dilemma of choices among business investments was well expressed by the president of a department store in Buffalo: "we make energy improvements to help control our operating costs, but there's a limit. Remember capital for energy improvements does not increase sales." At the same time, for owner-occupants, there is no way to escape the burden of energy costs which investor-owners can duck with passthrough leases. The president of a national motel chain in San Antonio said he expected to see energy

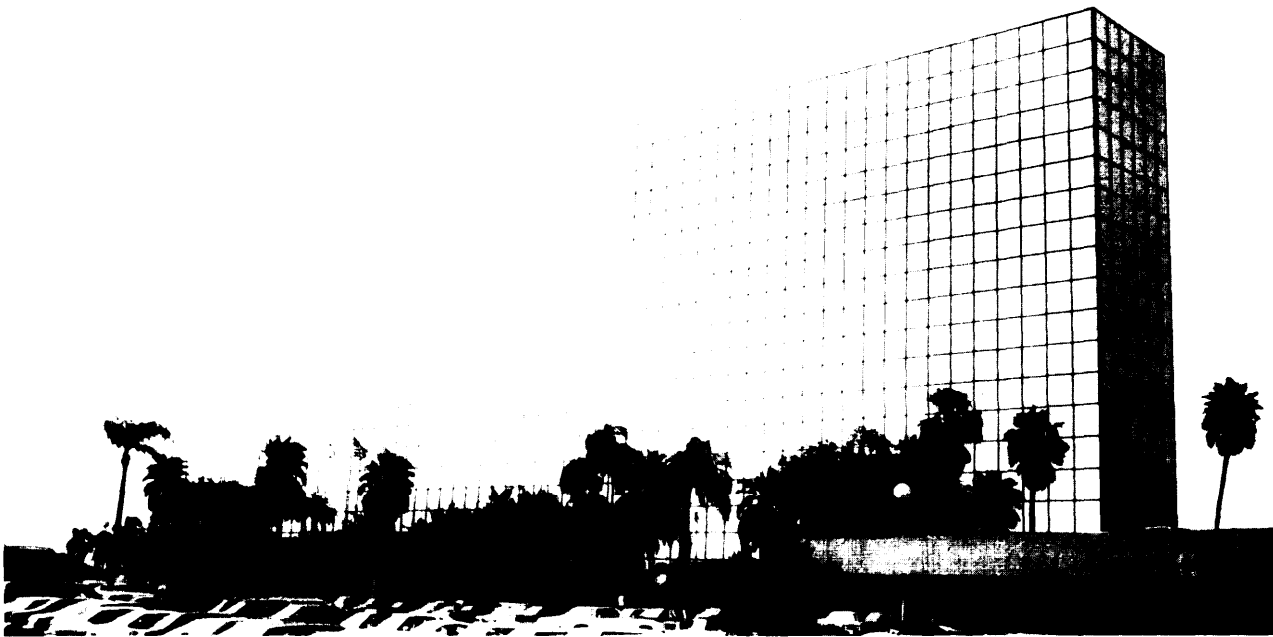

Photo credit: Steve Friedman

Energy efficient features of this building in Tampa, owned by a corporation, include double glazing, and controls on outside air mixing

costs exceed mortgage costs in the near future, “I increase my return by controlling my costs—now, not later.”

Large corporations have good access to capital for energy improvements. Most moderate to large-sized corporations have formal capital budgeting procedures and routinely make capital investments drawing on financing from a variety of sources: retained earnings, corporate debt issues, lines of credit, and commercial loans. Of the five local and three national corporate owners interviewed, who had made major retrofit investments, all had been financed with internal funds.

Large corporate owners also have good access to professional advice. They have professional facility managers as part of corporate headquarters staff. They often can afford to employ internal experts in energy conservation or can retain consultants. The basic corporate planning cycle encourages explicit consideration of energy investments.

The corporate owners interviewed all mentioned 3- to 5-year paybacks as the criteria they apply to energy investments. In contrast to many types of investor-owners this period is not related to their holding period for the building but rather to a corporatewide business standard of return for nonmanufacturing facility investments. Unlike smaller owners, corporations have both financial and professional resources to make energy investments based on these criteria.

**Small Business Owner-Occupants.** Small businesses may be individual proprietorships, partnerships, or small corporations. Like large corporations, they own the buildings to use in their businesses. Said a San Antonio shopping center owner of the typical small shoestore “they’re in business to sell first and in times like this, it’s tough to do everything you might like or should do.”

Information on the motivation of small businesses is scanty. A few interviews were conducted directly with small business owners, mostly individual proprietorships. Further insight was provided by several brokers of small business properties.

Compared to large corporate owners of their buildings, small businesses have much less access to internal funding for energy improvements and usually limited access to outside capital at reasonable rates. Such owners are particularly dependent on maintaining reasonable cash flow from their businesses. Energy investments with high initial costs and burdensome debt service due to high interest rates, short loan terms, or both (see discussion in the last section of this chapter) are serious obstacles to energy conservation investments.

Small business owners also lack the time and financial resources to obtain good professional advice about energy investments. Because of their dependence on adequate cash flow the risks of a mistake are also much greater than for the large corporation. For all these reasons, small business, especially individual proprietors, appear to limit energy investments to those that will pay back in 1 year or less.

#### **Owner-Occupants of Multifamily Buildings.**

This category of owner is very similar to the small business owner, lacking time or professional advice to learn about energy improvements and lacking sufficient cash flow to fund energy investments from internally generated funds but with very limited access to outside financing at reasonable interest rates. However, because these owners also live in their building and pay some of its energy costs as part of their own household expenses, there is a slightly greater chance that they will consider retrofits with paybacks of up to 3 years. Of the very small number of multifamily buildings reported as retrofitted in the building owner survey, two were owner-occupied small buildings in Buffalo.

**Condominium-Owners.** Owners of condominium apartments are responsible for energy improvements to their own units, but the improvements to the buildingwide systems are the responsibility of the condominium association. Condominium association fees have been rising at rapid rates and condominium trade associations have recognized the importance of rising energy costs.

Nonetheless, for a systemwide energy improvement to be made, the condominium asso-

ciation, in a collective process, must agree on the improvement's value and pay for it from replacement reserves, debt finance, or a proportionate assessment to each owner. The four condominium associations interviewed reported mixed experience with lenders. Collateral is a problem for some because the condominium association does not hold title to the building. For some associations their authority to levy special assessments on owners has been sufficient to obtain loans. None of the four associations interviewed had made a major retrofit investment but two had made minor investments. In general, condominium owners appear motivated to consider energy retrofits but are handicapped by the awkwardness of their form of ownership from making commitments to longer payback investments.

**Investor-Owners: General.** Investor-owners own buildings only for the economic return they bring as real estate. Investor-owners neither live in their buildings nor do they use them primarily to house their businesses, although for convenience they are likely to have their own offices in one of the buildings they own. For an investor-owner an investment in the energy efficiency of the building must contribute to one or more of the three forms of economic return in real estate:

- **Cash flow.** Energy retrofits may decrease expenses in buildings where the owner pays all or part of the energy expenses. For buildings with net or passthrough leases, energy retrofits only increase cash flow if they allow higher rents to be charged or reduce vacancies.
- **Tax benefits.** Many energy retrofits can be depreciated and used to shelter taxable income. Interest on loans to pay for energy retrofits can also be deducted from taxable income. Tax credits from Federal or State governments may also be available to owners for specific energy investments.
- **Resale value.** An energy retrofit that increases a building's net income will have a direct effect on its resale value as the net income is capitalized by appraisers at some rate typical for that type of building and location (see Box E.—As the Appraiser Sees

It). Appraisers usually use 3 years average net income to make this determination. A recent energy retrofit without 3 years' impact on net income may not have much impact on resale value.

The main types of investor-owners—institutional, development company, partnership, and individual—emphasize different elements of the return on real estate and thus have distinctly different motivation for energy retrofit to their buildings. The building owner types also differ in the financial and professional resources they can bring to bear on energy investments.

**Institutional Owners.** Insurance companies and pension funds are the major form of institutional owners. Typically they hold buildings for holding periods of 12 years or more, emphasizing the healthy cash flow in the buildings over the long term. For this reason, energy retrofit which promises to increase cash flow over the long run is viewed as sensible. Such owners have the longest payback criteria of all owners, 5 to 7 years.

Insurance companies and pension funds have extensive financial capacity to fund building improvements internally. They also support a professional management and property investment staff to recommend and carry out investment and management practices to increase income from a property and improve its long-term value. Property managers (see Box F: The Role of the Property Manager) and in-house property planning staff for institutional owners have clearly defined job performance objectives, incentives, and capital budgets. Cost consciousness is rewarded. Operational improvements to save energy have been a property management task since 1975 and annual energy audits and building energy system inventories a regular routine. All 10 national institutional owners interviewed had made major capital investments in their buildings including full replacement of boilers and air conditioning systems and installation of sophisticated computerized energy timing and control systems.

**Development Companies.** The four national and four local development companies interviewed varied in their expected holding periods

### **Box E.-A Question of Value: How the Appraiser Sees it**

Do energy improvements enhance a property's value? To appraisers, the answer is not at all clear. But what is clear is the importance of their response to this question in a go/no-go retrofit investment decision. The appraiser's consideration of the impact of energy improvements on value can be crucial to some lending decisions if loan-to-value ratios are close to accepted limits and can also be important to the return assessment of owners if the improvement is capitalized into the value of the building.

Professional appraisers should, in theory, consider the improvement to value that results from a reduction in energy costs. In income properties, this would occur through the capitalization of the resulting higher net income. The appraiser normally does this by examining 3 years' operating results on the building under study and operating results of comparable buildings to arrive at stabilized income and expense data. Comparability of energy equipment among other things should be considered in selecting buildings for comparison.

At present, several factors make it difficult for appraisers to conform to this procedure. Few buildings exist with 3 years of results of energy improvements, either to use as comparable, or to appraise. Hence, there is little experience to use in judging indirect or direct impact on market value. As yet, no other standardized methods for incorporating energy concerns have been developed. The appraisal division of a commercial bank in San Antonio instituted lifecycle costing as a nonstandard way to approach the issue and to serve as a proxy for acceptable comparable.

In the face of limited information, many appraisers have responded to rapidly increasing energy costs by, in effect, incorporating the increased risk in their valuation judgments. This has occurred by raising capitalization (which lowers the effective multiplier applied to income to arrive at value). The higher rate reflects many factors, but the recent rates of inflation in interest rates, operating costs and energy prices are considered to be among the major factors that result in higher risks.

Efforts have been made by appraiser professional associations to improve their members' skills in evaluating energy conservation in real estate. In addition, many appraisers are active in local building owner and manager associations, which have become very concerned about energy.

### **Box F.-Role of the Property Manager**

Professional property managers play an important role in building operations for many owners, particularly institutions and partnerships. Property managers have the discretion to identify and make operational energy improvements, but only limited authority to make capital improvements. For example, at one large office building in a case study city, the manager's authority was limited to improvements costing \$5,000 or less.

Managers can, and often do, identify both operations and capital possibilities for reducing energy costs. In some cases, such as hotels, the compensation formula is based on net income, which actively encourages managers to seek

ways to cut costs. The presence of professional managers has led to widespread adoption of operational improvements in larger office buildings and to more active consideration of energy measures elsewhere. This is true regardless of who owns the property. In addition, professional managers interviewed were by far the most knowledgeable about energy costs and technical options. They felt that there was a steep dropoff in awareness and knowledge among the less professional managers and owners who were not themselves active full-time managers. There appears to be less knowledge and less conservation where there are no professional and/or full-time managers.

for buildings but on the whole their holding periods were shorter than those of institutional owners and their payback criteria for energy retrofits were correspondingly shorter (1 to 3 years). Short payback criteria can be explained partly by the greater difficulty of development companies in financing retrofits. Their investments have been traditionally highly leveraged with a very high ratio of debt to equity (although they are now moving more toward equity financing). This leaves very little flexibility to add further debt. Development companies have also tended to specialize in owning shopping centers with fully indexed net leases, so that the incentive to retrofit is somewhat less than that of owners of other commercial buildings (see discussion of commercial buildings below). Of the eight owners interviewed, four had made major retrofits, two had made minor retrofits and two had done nothing.

**partnership: General.** The popularity of the partnership, now the most common form of real estate ownership, is in part due to the tax status of this form of ownership and in part due to the small capital requirements for entry. The partnership is itself not a taxable entity but a tax conduit which passes on the tax advantages of real estate ownership fully and directly to the partner/investor. While partnerships are interested in the cash flow and resale impact of an energy retrofit, they are very concerned about leaving intact or enhancing the tax benefits of a property. Since partnerships are formed only for purposes of owning a particular piece of property, it is often difficult for the partners to agree on further capital investment once the particular deal has been struck. The tax benefits to a partnership diminish after 7 to 10 years as interest and depreciation deductions diminish and at this point, the property is frequently sold.

**National partnership Syndicates.** These are the most sophisticated of the partnerships and bear some resemblance to the institutional owners. All syndicates have a general partner, responsible for managing the property held by the syndicate, and many limited partners who buy into the syndicate either privately or by purchasing publicly placed security investments.

National syndicates maintain professional management staffs in-house and onsite. As part of the syndication, reserves are set aside for building expenses sufficient to fund most improvements including moderate energy retrofits without returning to the investors for extra equity capital. For these partnerships, energy or other building improvements are an aggressive way to increase building value and create more return for investors than passive management would create. As the head of a national syndicate's property management department explained: "Any new value we create is a selling point to our customers (investors), old or new. The sophisticated investors we deal with want quality in their product not just shelter."

Of the five national partnership syndicates interviewed, three had made major energy investments in their buildings and the other two had made minor investments. The national syndicates agreed on a 3-year payback as a suitable criteria for retrofit.

**Local partnerships.** Local partnerships may be formed with a general partner and limited partners or with conventional (equal) partners. They almost always have far more limited financial and managerial resources than the national partnership syndicates. Reserves set aside at the time of creation of these partnerships are generally insufficient to cover major building improvements such as energy. It is usually very difficult to raise further equity capital from the original partner investors. Said a San Antonio general partner: "Thirteen can put the new money up but two others (partners) don't have the cash on hand; so I can't do it; we are simply talking group dynamics."

Of the 20 local partnerships interviewed, only four had made major energy investments, eight had done nothing. One or two years was the standard payback criteria for retrofits, corresponding to the short (7 to 10 year) holding period typical of partnerships. If they are done at all, energy retrofits are done early in the property's holding period. As the San Antonio general partner explained, "After the sixth year, I'm looking at another building purchase and syndicate setup, not the one I'm about to get out of."

**Individual Investor-Owners.** Most individual investor-owners, like individual owner-occupants, are owners of small amounts of property and this constrains their ability to make energy investments in their buildings. Because most individual owners lack financial depth, maintaining a building's cash flow is usually far more important than sacrificing current cash flow for the sake of future resale value. Many individual owners also lack sophisticated property investment advice that would help them evaluate the resale potential of their property. A large Buffalo broker of small property observed:

Resale value is important but requires some sophistication to be appreciated. Your Mom and Pop single investor or owner who thinks his single unit or two is going to support his retirement or give him financial security is not going to think in terms of future value. It's hard to get them to think of real estate as an investment ... the way an investor where real estate is his

living would; it is a thing to be kept and kept up, not improved for investment reasons,

With today's high cost and inaccessibility of debt finance, the cash flow of an individual's property is threatened by substantial energy investments. Most of those individual owners interviewed set 1 year as their maximum energy retrofit criteria. This extremely short payback reflected their uncertainty about the risks of an energy investment and their fears of a mistake as much as insistence on a high rate of return. A few individuals personally concerned about energy efficiency accepted higher paybacks than this; one as long as 10 years.

**Conclusion.** In today's climate of high cost of finance and continued uncertainty about the risks and benefits of energy retrofit, building owner types—institutional owners, corporations, national partnership syndicates, and development companies—with good access to in-



Photo credit Steve Friedman

The individual who owns this office building in a Northern city has made low capital cost investments in caulking and boiler efficiency. The owner is currently unable to finance a new boiler

ternal capital funds and professional information are far more likely to retrofit their buildings than owners—individual and local partnerships—who are constrained by their building’s cash flow from taking on the high debt service cost of outside finance and who have poor access to

professional advice about retrofit. Despite these handicaps there is somewhat more chance that smaller owners will retrofit their buildings if they occupy them than if they hold them as investor-owners.

## IMPACT OF BUILDING TYPES ON THE LIKELIHOOD OF RETROFIT

It is not only the owner type that affects the likelihood that a building will be retrofit, it is also the building type—office, retail, hotel, or multifamily. Each building type has its own characteristic market response to energy costs, leasing structure and balance between income and expense and these all affect the likelihood that a particular type of owner will retrofit that building rather than another type of building.

Of all the types of buildings covered in the building owner survey, office buildings were by

far the most frequently retrofitted, followed by retail buildings and hotels (see fig. 36). Multifamily buildings were retrofitted much less frequently than the other types. Out of 29 multifamily buildings covered in the interviews, only four had been retrofitted at all, only one of these with a major retrofit. This imbalance between retrofits of office buildings, multifamily buildings and other buildings is also echoed in a recent survey of buildings with documented retrofits and energy savings by Howard Ross and Sue Whalen. Out of 220 buildings with documented

**Figure 36.— Frequency of Retrofits Among Building Types Covered in Building Owner Interviews\***

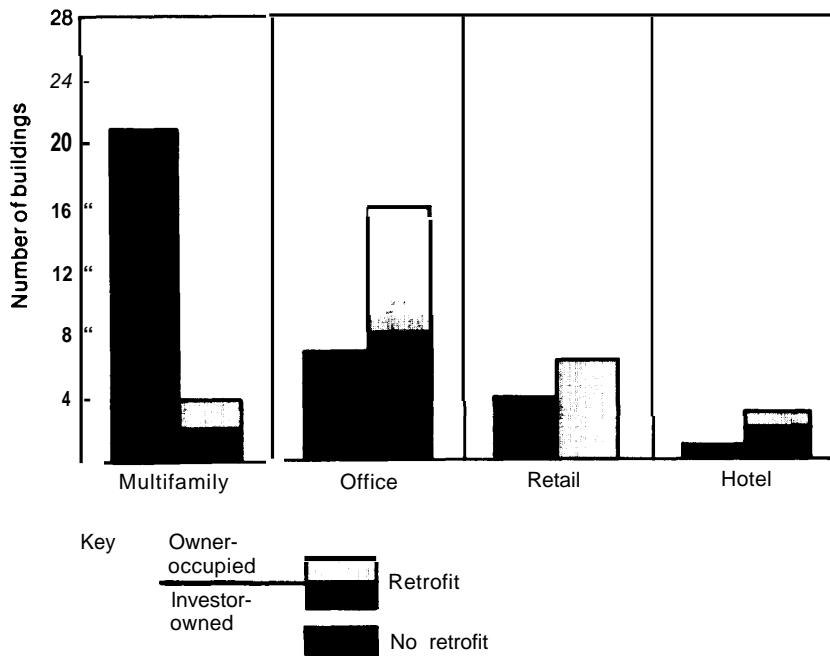

\*Interviews in Buffalo, Des Moines, San Antonio, and Tampa.

SOURCE: Office of Technology Assessment.



retrofits, 38 were office buildings, four were hotels, while there was only one shopping center and one multifamily building.<sup>10</sup>

part of the explanation is that multifamily buildings tend to be owned by the types of own-

<sup>10</sup>Howard Ross and Sue Whalen, "Building Energy Use Compilation and Analysis: Part C: Conservation Progress in Commercial Buildings" (unpublished), May 1981, revised August 1981. To be published in *Energy and Buildings* magazine, Lausanne, Switzerland.

## LIKELIHOOD OF RETROFIT IN MULTIFAMILY BUILDINGS

The problems of the owner types who own the bulk of multifamily buildings explain much of their very low rate of retrofit. Individual owners lack access to capital and are constrained by their dependence on the buildings cash flow from taking on high debt service to pay for retrofit. Local partnerships may put capital into retrofit at the time of purchase, but it becomes increasingly difficult to obtain funds from the partners after that. Both categories of owners lack information on retrofit opportunities and risk and both have much to lose from a mistake. Multifamily buildings owned by better financed and informed owner types such as insurance companies, pension funds, and national partnership syndicates are somewhat more likely to be retrofit than those owned by individual owners and local partnerships.

The type of owner, however, does not explain all of the low rate of multifamily retrofit. Owners' problems are exacerbated by overall problems in the market for multifamily buildings.

**Squeeze on Cash Flow.** More than owners of other building types, multifamily building owners have been caught in an income squeeze both because of rising costs and their inability to raise rents. The latter is attributable to several factors, including rent control, consumer resistance, and management efforts to minimize turnover in tenancy. Using operating indexes from actual special samples of properties in one area, a Rand Corp. study of multifamily units underlines the expense-revenue gap that emerged

ers—individuals and local partnerships—who require very short paybacks to make any retrofit at all and who frequently do nothing to their buildings in response to rising energy costs. However, the problem of retrofits to multifamily buildings goes beyond ownership. The sections that follow discuss the particular market characteristics of multifamily and commercial buildings that affect their prospects for retrofit.

in the 1970's. "Generally, the evidence suggests operating cost increases of 8 to 10 percent annually, compounding to between 115 and 160 percent for a decade in which rents rose by 74 percent and vacancy rates (which also affect revenue) changed only slightly." This trend leads to diminished rates of growth in net operating income, and results both in relatively less money available for debt service and in lower market values. In the face of recent increases in mortgage interest rates, this creates a cash squeeze for any new owner or a relative diminution of value for a potential seller.

Energy cost increases have been a major contributor to this cash squeeze. As figure 37 shows, increases in fuel and utility costs alone outpaced average rental adjustments by more than **2 to 1 (98 to 39 percent) between 1970 and 1976**. The trend continued from 1976 to 1979, according to data from the Institute of Real Estate Management (IREM). Heating costs per square foot increased over 3 years anywhere from 62 percent for elevator apartments to 120 percent for low-rise small buildings (see table 35).

Average rental adjustments for multifamily buildings have not kept pace with increases in energy costs for reasons that elude the experts although many explanations have been given. One is that traditional renters such as newly-

<sup>11</sup>Ira S. Lowry, draft report, "Rental Housing in the 1970's: Searching for the Crisis," the Rand Corp., November 1980; presented at HUD Conference on Rental Housing, Nov. 14, 1980. See also David Scott Lindsay and Ira S. Lowry, *Rent Inflation in St. Joseph County, Indiana, 1974-78*, the Rand Corp., 1981.

**Figure 37.—Apartment Operating Revenues and Expenses 1970-76**

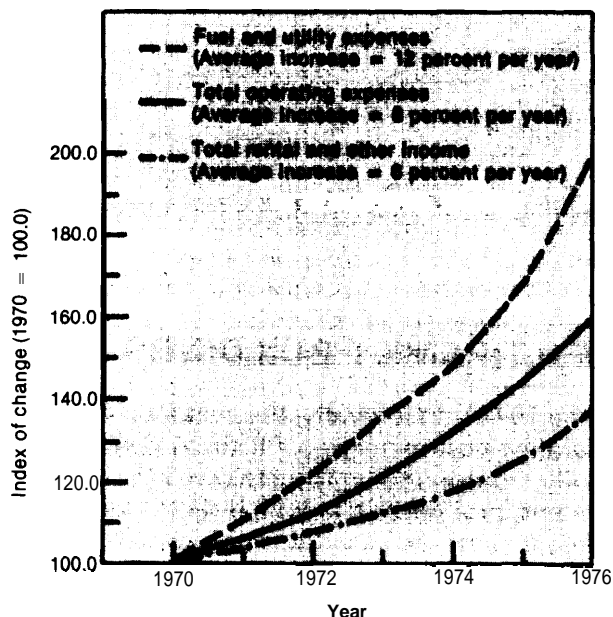

NOTE: Data from 189 properties.

SOURCE: Touche Ross & Co. using data from Booz, Allen & Hamilton (May 1979). *Achieving Energy Conservation in Existing Apartment Buildings: Appendix D.*

**Table 35.—Annual Heating Fuel Costs in Apartment Buildings**

| Apartment building type        | Heating cost (dollars/ft <sup>2</sup> of rentable area) |        | Percent change |
|--------------------------------|---|--------|----------------|
|                                | 1976  | 1979   |                |
| Elevator . . . . .             | \$0.21  | \$0.34 | 62%            |
| Low-rise (24 units +). . . . . | 0.14  | 0.23   | 64             |
| Low-rise (12 units). . . . .   | 0.15  | 0.33   | 120            |
| Garden . . . . .               | 0.13  | 0.23   | 77             |

NOTE: Only buildings reported for 4 consecutive years.

SOURCE: *Income Expense Analysis: Apartments 1980 Edition*, Institute of Real Estate Management.

weds, single households, and empty-nesters, in response to rapid appreciation in property values and the tax-deductible status of mortgage interest, have been shifting to single-family or condominium ownership for investment as well as housing, and are leaving the rental market to a larger proportion of lower income people, who are less able to adjust to increases in rent. There is also some evidence, however, that

lower income renters have increased the quality of their housing over the decade without increasing their average rent. Finally, some of the lag in rents can be explained by a preference of some multifamily building owners to reduce vacancy ratios and retain long-term tenants by holding back rent increases. Some observers practicing strict market economics believe that the overall explanation for the possibility of a lag in rents relative to expenses may be that there is an oversupply of multifamily houses.<sup>12</sup> Careful studies have shown that this indeed may be a cause of abandonment of multifamily houses in certain areas (see discussion in ch. 5).

The potential for rent adjustment to cover utility costs varies greatly from strong rental housing markets to weaker ones. Among the case study cities, owners in Buffalo and Des Moines perceived the rental market to be weaker and the potential poor for raising rents sufficiently. Several owners expressed a strong sense of crisis in the interviews, foreseeing grim futures as real estate apartment owners unless they "got out soon" at a decent sales price or by converting to condominiums even when they acknowledged that the market for condominiums was poor in their cities. Apartment owners in the stronger markets of Tampa and San Antonio were more optimistic. Even in these markets, however, institutional owners and national syndicates expressed an intention to reduce the amount of investment in multifamily property.

Most important of all, an apartment owner's ability to avoid the squeeze on cash flow described above depends directly on whether the owner pays for heat and electricity or whether tenants do.

**Prospects for Retrofit When Tenants Pay Utilities.** Almost one-half of the multifamily apartment units in the country are fully tenant-metered (see table 36). If structurally feasible, multifamily owners have converted to tenant metering as the first and often final response to

<sup>12</sup>This debate is set forth in several papers prepared for the November 1980 HUD Conference on Rental Housing, Anthony Downs, "The Future of Rental Housing—Overview;" Ira Lowry, "Rental Housing in the 1970's: Searching for the Crisis. "

**Table 36.—National Distribution of Metering Types of Rental Units<sup>a</sup>**

| Type of rental unit   | Percent of total |
|---|------------------|
| Master (full) . . . . .   | 19 %             |
| Tenant (full) . . . . .   | 46               |
| Mixed (tenant pays <i>electric</i> but not heat or hot water) . . . . . | 29               |
| Miscellany <sup>b</sup> . . . . .                                       | 6                |
| Total . . . . .   | 100 %            |

<sup>a</sup>Town or more units  
<sup>b</sup>Systems too mixed to Categorize

SOURCE *National Interim Energy Consumption Survey* 1978.79, Department of Energy, Office of Consumption Data.

escalating energy costs, even though conversion costs were clearly capital investments (costing from \$125 to \$1,600 per apartment unit with a median of about \$1,600).<sup>13</sup> Yet payback is very rapid, depending on how the base rent is adjusted: paybacks of 1 year or less are not unusual, although the average simple payback is 1 to 2½ years. There are several benefits of tenant-metering, in addition to sheltering the landlord from the full impact of energy increases:

- Many buyers, particularly national syndicates and institutional investors, are unwilling to consider purchase of multifamily property unless tenants pay the full cost of utilities. Conversion to tenant metering, therefore, creates resale value in itself.
- Banks are more willing to refinance or lend to tenant-metered building owners.
- Professional journals, particularly the widely read *Journal of Property Management*, have taken an advocacy stance toward tenant metering with clearcut articles describing investment return mechanics and owner benefits, including resale value, from tenant metering. There is practical advice on such topics as tenant counseling techniques during remetering.
- Many States, particularly in the South and Southwest, have made tenant electrical metering in new buildings and sometimes existing ones a mandate of State conserva-

tion policy law.<sup>14</sup> Five out of seven apartment owners interviewed in San Antonio had tenant-metered buildings partly because it is required by law.

Owners interviewed in both the case study and national interviews described little negative market impact as a result of conversion. Tenants have not reacted against tenant-metered buildings during sellout or in existing buildings during remetering. To the contrary, some owners noted that tenant metering successfully transferred to the utility companies the “bad guy” image that owners formerly bore for energy increases in gross rent.

In the opinion of most landlords interviewed for the study, tenant metering has created greater and more reliable savings in energy consumption than any other improvement they could have made because tenants make behavioral adaptations as a result. Savings from tenant metering have also been documented. A best estimate is 5 percent for heating and as much as 20 percent for other energy.<sup>15</sup> At the same time, tenant metering may result in higher per unit energy costs for tenants in utility areas where large users pay significantly lower rates than small individual users. (See ch. 5 for more discussion of this point.)

For all its advantages in inducing energy conservation behavior by tenants, tenant metering provides virtually no incentive for apartment owners to invest in greater efficiency of their buildings. There is no incentive to improve insulation levels, add storm windows, or improve heating system efficiencies (usually of decentralized systems since central heating and cooling systems cannot be tenant metered except with great difficulty and expense). None of the owners of tenant metered buildings had made energy investments except to make operating

<sup>13</sup>Jeffrey M. Seisler, “Escaping the Energy Bite: Converting Master Meters,” *Journal of Property Management*, May/June 1980.

<sup>14</sup>*Metering*: States banning all master metering include California, Florida, Maryland, Michigan, North Carolina, Oklahoma, Rhode Island. States banning master metering for electricity include Louisiana, Massachusetts, Minnesota, New Jersey, New York, Oregon, and Texas. Source: Steven Ferrey & Associates, *Fostering Equity in Urban Conservation. Utility Metering and Utility Financing*, to be published as a working paper to this report.

<sup>15</sup>Lou Mc Lelland, *Op. cit.*

improvements in the heating and cooling and lighting of the building's common areas.

In theory, energy conservation investments can enhance the value of the property by permitting the owner to charge a higher rent, allowing for the lower utility cost to the tenant. In theory, if everyone else in the market also made energy efficiency investments, or there were substantial new energy-efficient competition from new buildings, an owner would be forced to improve in order to compete. Also in theory, if no one else improves, the owner could improve his competitive position if he could market the necessarily incremental rent adjustment.

To obtain the higher rent, however, requires both a sound market and marketing skill. The tenant must be convinced that the total occupancy cost will still be comparable to the lower rent competition. Given the fragmented nature of multifamily ownership, levels of professionalism, traditional tenant-landlord relationships and tendency to hold rents down to reduce turnover, it is unlikely that this logic will be readily adopted by the typical multifamily building owner. Some sophisticated national syndicates and management organizations interviewed for the study, however, are making the link between conservation and value. It is conceivable that over the long run, the adoption of such a strategy by a few large operators in each market or the advocacy of such an economic rationale by one of the trade information sources might stimulate such a perspective.

**Prospects for Retrofit If the Owner Pays the Utilities.** Although multifamily owners are converting to tenant metering whenever possible as a reaction to the rising cost of energy, it is not possible to convert all types of heating systems, (especially central air systems, central steam and hot water systems, ) to tenant metering except at great expense. As the above table 36 showed, more than one-half of all rental units are fully master metered or master metered for heat and hot water and tenant metered for electricity.

Multifamily owners whose buildings have not been or cannot be fully tenant metered are

aware of and concerned about rising energy costs. They have a strong incentive to contain costs that are rising faster than other expenses and threatening to become uncontrollable. However, they are limited to actions which can be paid for within the confines of their own cash flows since financing is either too costly and/or unavailable. An individual owner of over 200 apartment units in Buffalo commented: "I would normally want to spend \$5,000 to save \$2,000 a year, but not when I can't afford to service the \$5,000." A large apartment owner and broker in the Southwest bluntly summarized a basic constraint for city apartment owners in today's economic environment: "Apartment managers must conserve capital in the



Photo credit: Steve Friedman

Retrofits to this HUD-subsidized apartment building for the elderly in Tampa included improved chiller efficiency and a shift from incandescent to fluorescent lights

early years. They are not going to want to touch the cash flow.” Only if the building owner has access to government property rehabilitation funds (see ch. 9) is he likely to be able to service the debt within the building’s cash flow.

For most multifamily building owners, the only benefit of energy retrofit is cost savings. There is no discernible marketing advantage; the level of tenant demand for rental units that are energy efficient (and which might therefore have more controlled future rent increases) is low. The tenants’s rental decision is first linked to location and the size and appearance of the apartment, regardless of energy features.

Energy retrofit for resale value is also not an important motivation for the large share of multifamily building owners who are individual owners, especially those with small amounts of property. Such owners do not generally have the planning time, staff or perspective to make

an energy investment for return “down the road.” The concept of future return through enhanced resale value as a result of energy improvement seems nebulous. In multifamily markets with many weak spots, such as Buffalo and Des Moines, a building’s future, even if viable now, might be uncertain.

To sum up, although an owner of a master-metered multifamily building has strong motivation to curb the increase in his expenses by controlling energy costs, the constrained cash flow of many multifamily buildings (coupled with uncertainty about retrofit results) makes it extremely hard to expect to pay for a retrofit out of retained earnings or to service a loan to pay for it. The uncertain long-term viability of multifamily buildings constrains an owner’s motivation to invest in the energy efficiency of multifamily buildings for its resale value.

## LIKELIHOOD OF RETROFIT IN COMMERCIAL BUILDINGS

Commercial buildings have been retrofit far more frequently than multifamily buildings, according to the partial data available. To some extent this is explained by the better financed, better informed owner types which own commercial buildings. Many commercial buildings—office, retail and hotel—are occupied by their owners which are large corporations, able to plan and carry out a retrofit.

Within the category of commercial buildings, however, there are significant differences among office buildings, shopping centers, department stores, and hotels in the sensitivity of owners and tenants to rising energy costs, the rewards for retrofit and the resources for making energy investments. The sections which follow describe these differences.

**Office Buildings.** Office buildings appear to have been retrofit in greater numbers than other building types. Out of 27 interviews with office building owners in the case study cities, 20 had retrofit their buildings. Retrofits by and large were carried out by corporations who owned

their own buildings and by institutional and national partnership syndicate owners. Retrofits mentioned included installation of task lighting, heat pumps, new boilers and timing and control systems. Two of the retrofits of corporate headquarters buildings were carried out as part of overall modernization programs. In both modernization cases, in Des Moines and Buffalo, the directors of facility planning reported that such energy improvements might have been made anyway, but “only very gradually.”

For other kinds of owners, limits on energy investments in office buildings are typically set within the constraints of the building’s cash flow because the extremely high cost of outside financing eliminates the possibility of borrowing to pay for a retrofit. Fortunately office buildings offer many opportunities for low-cost/no-cost retrofits (see Chapter 3: The potential for *Building Retrofit*). Many building owners interviewed had made low-cost investments such as: installing timer devices to turn systems and lights off from 6 p.m. to 7 a.m. when the build-



Photo credit: OTA Staff

Retrofits to this office tower owned by a bank in Tampa included elimination of mixed cooling and reheat, reflective film, computerized temperature controls, and high-efficiency fluorescent lights

ing is not in use; reducing lighting levels and installing more efficient bulbs and making many different adjustments and improvements to the building's heating ventilating and air-conditioning systems.

Mentioning the need to stay within the building's cash flow, several building owners said that any capital investment in energy retrofit less than 25 cents per square foot would be considered feasible. A 25- to 50-cent-per-square-foot improvement cost would bring more scrutiny. Fifty cents per square foot was the basic cost cutoff point for the office owners interviewed. Alternatively, another cutoff measure was the building's total energy bill. An office owner in

Des Moines observed: "The building costs \$40,000 a year in total energy bills. No matter what I think about the future, I have a hard time laying out a capital investment costing more than my bill, which is what a window retrofit would do to me." The office owners interviewed for this study acknowledge they are basically on the "last round" of the low-cost/no-cost improvements for controlling energy cost and would have to make capital improvements next.

**passthrough Lease Disincentive.** For investor-owners of office buildings, by far the greatest disincentive to retrofit is the prevalence of the passthrough lease in existing class A and most class B offices. passthrough lease terms vary. Escalators include direct operating costs, average of costs in other buildings, operating cost increases above the base year, and CPI-indexed leases. In class B offices, some gross leases still exist, but owners are gradually rolling them over to passthrough leases that include an energy escalation clause. Lease terms for small tenants are also getting shorter, down from an average of 7 to 10 years in older office buildings to an average of 3 to 5 years.

passthrough leases allow the owner to recover utility and other expenses but are usually written to prohibit passthrough of debt service to cover the capital expense of an energy retrofit investment. With passthrough leases the chief incentive for energy retrofit by an investor-owner is to curb the costs of energy for the common spaces that can average **40 percent of the total** energy bill for a high-rise office building.

There are signs, however, that new kinds of passthrough leases are being developed to permit energy efficiency investments. Large owners such as insurance companies are starting to institute a new uniform passthrough in their leases. This provision would allow the owner to pass through to the tenant the capital costs of energy improvements that benefit only the tenant until the investment is paid back by energy cost savings. At that time, any future savings benefits would accrue directly to the tenant. Owners pioneering this type of lease feel that although tenants need to be convinced of the

merits, such a lease adjustment would give the owner an incentive that does not now exist, while offering tenants a saving that a standard passthrough lease never would. None of the institutional owners interviewed had as yet introduced this type of lease into their buildings.

**Energy Retrofit to Improve Marketing.** In current markets for office buildings, tenants rarely seem concerned about total occupancy costs including energy passthroughs although a few office owners in Buffalo mentioned a growing tendency for lease competition to be based on quoting comprehensive rent including utilities. More typical is the situation cited by an executive for a national housing firm. “Tenants don’t seem to care in general; they still look, as they have traditionally, to the quoted rent, not the escalators.”

All office owners acknowledged that tenant concern about the energy costs in passthrough leases might become a market factor in the future especially in a stagnant economy where office users would tend to be more zealous about every cost-cutting opportunity (despite the relatively small cost energy represents to a typical office user). Even owners with short holding periods would probably invest in energy efficiency if the market called for it. Owners interviewed cited four market conditions which might spur such a change.

- For tenants “shopping” with expectations of rising costs, lower cost will improve an owner’s marketing position. Managers are aware of this.
- Significantly improved energy efficiency of new buildings can reduce the effective rent spread between new and energy efficient existing buildings, especially in a soft market. Managers of older buildings may have to look for ways to protect their competitive position, especially vis a vis some new hotels and office buildings that are benefiting from subsidized financing or other government programs such as industrial revenue bonds, tax abatement and urban development action grants.
- New office construction in many downtowns has been substantial, creating strong

competitive pressures on existing offices. As yet, there has been little overbuilding, but with the economy weak, in some cities offices may become temporarily overbuilt. If this occurs, it will put a downward pressure on rents and hence provide greater incentive to control costs (and therefore total rents) to keep or attract tenants.

- Office owners and managers generally understand that the long-term value of the property can be enhanced or at least preserved by controlling energy costs.

In summary, operational improvements and low-cost investments are the main response to rising energy costs in office properties. While large corporate owner-occupants (and to some degree, banks) may make capital improvements, other office owners are less motivated and prefer to pass energy costs on to the tenant. For those with the interest, poor access to financing and good technical information continues to be a substantial barrier.

**Retail Owners and Energy Investments.** Except for some owner-occupied department stores and small stores, most retail buildings are owned by investor-owners. Shopping centers within cities are commonly owned by real estate development corporations that may or may not be subsidiaries of major retail corporations, by institutional owners and by large partnerships, including national syndicates. Urban retail strips or freestanding small retail stores are generally owned by individuals or small local partnerships. Downtown department stores are owned by their corporate owner-occupants, as are generally the department store anchors of shopping centers. Type of retail ownership is a factor in decisions to retrofit, but the most critical variable for retail owners is lease standards.

Except for owner-occupants of freestanding department stores, owners of retail buildings today generally charge their tenants rent on a net lease basis with a duration, except for those of anchor stores, often averaging 3 to 5 years. In older shopping centers or retail strips in cities, gross lease standards and longer term contracts of the past still exist but for retail owners the net lease has become standard at lease-up or re-

newal. In fact, one of the ways a buyer can add value to an older shopping center purchase is to convert gross leases outstanding to net leases. The net lease has made a shopping center one of the most valuable and coveted real estate investments because of the long-term security it provides.

Net leases operate essentially like pass-through leases in offices; a wide range of total net costs are charged to tenants, but energy costs in a retail lease are generally borne by the tenant. The owner is responsible for whatever common area energy costs may exist, such as mall or arcade lighting and HVAC. The net lease, according to retail owners in case study and national interviews, is the single key investment disincentive for energy retrofit of these buildings by the owners. It is a bigger disincentive for retail owners than the passthrough lease is to office owners. In contrast to office tenants, retail tenants on whom the passthrough burden falls cannot "shop around" and exert market pressure on owners. Retail tenants have to go where the goods will sell, first and foremost.

None of the small number of investor-owners of retail buildings interviewed had made operational improvements in older city retail shopping centers and retail strips on net leases. Although new centers are being outfitted with energy efficiency components such as computerized energy management systems as a marketing lever, this type of retrofit for an older center or strip is very costly, and difficult to implement architecturally without disturbing the tenant. In these retail buildings, lighting reductions and savings in the common areas are the principal response to the energy conservation issue, with tenants making whatever improvements they see fit and find affordable for their own stores.

For retail owner occupants, such as downtown department chain stores, on the other hand, energy savings are direct business savings. Energy costs have been targeted by downtown department store chain owners as an area for cost-cutting. Sears recently reported at an energy conference that it had set up demonstration stores in which potential energy retrofit



Photo credit: Steve Friedman

For owner-occupied department stores, energy savings are direct business savings

products could be pretested before national application. Its overall energy conservation program was estimated to save the nation's largest retailer \$37 million annually. Another nationwide retailer with many urban outlets regularly directed stores to examine energy savings devices. It too has local tests of equipment before ordering widespread use.

For owner occupants of downtown stores interviewed for the report, energy improvements have been funded in conjunction with the annual capital budget. Improvements are linked to payback and to demands on capital for other purposes. The 3-year payback period for one chain was the same as that traditionally used for labor saving devices. Improvements such as lighting level adjustments are limited to those consistent with the competition as well. For the most part, the level of investment per store appears to be in the 25 to 50 cents per square foot range or less (\$25,000 or so). This level has not resulted in problems of competition for capital, but higher levels have not yet been tested.

**Hotel Owners and Energy Investment.** City hotel ownership has changed over the last decade as hotel chain corporations have frequently sold their buildings to private investors while maintaining a franchiser and sometimes a management role. The private owners typically are partnerships of various sizes. Recently, institutional owners have begun to increase hotel



holdings in their portfolios, partly because of the hotel industry's ability to adjust rates somewhat to counter rising costs brought about by inflation

Despite a shift to investor ownership, hotels are being retrofitted for improved energy efficiency. In hotel operations, energy costs are experienced directly by the operators and energy savings directly enhance net income margins. The standard contract for hotel managers includes a bonus incentive for net income performance. Hotel owners and managers find a definite economic incentive for energy investment in this type of city building and the result can be dramatic. "My costs per room this year are less than last year due to energy improvements," a motel chain president emphasized.

Hotel operators analyze energy investment in the context of their primary business objective—renting rooms and other facilities—and the alternative investments owners make to improve rent revenues—such as promotional campaigns. Hotel owners will not consider an improvement that causes significant tenant discomfort.

The degree of energy improvement is usually dependent on the hotel's capacity to fund them from internal moneys. Outside financing is considered neither feasible nor traditional. Hotel owners and operators are often uncertain about what could be done technically to a hotel in order to save energy in a cost-effective manner. This energy information problem is now being tackled by the hotel industry's main trade association, the American Hotel & Motel Association, which is using a Department of Energy (DOE) grant to study prototypical hotels and consumption patterns and to disseminate instructional and technical information resulting from the study to the industry.

The consensus of hotel owners concerning energy retrofit investments is nevertheless a clear one: energy savings and owner expense savings have a one-to-one relationship despite the theoretical prospect that rates could be adjusted daily to recover costs.



Photo credit: OTA staff

Retrofits to this hotel building in a Northern city included improved boiler efficiency, a shift from incandescent to fluorescent lights and radiator valves

**To sum up,** hotel buildings are likely to be retrofitted because energy costs directly affect profit margins and hotel operators are given incentives to reduce them. Office buildings are likely to be retrofit to a low level which can produce substantial savings given the usage patterns of the building. Retrofits beyond a low level will occur in owner-occupied office buildings and in tenant occupied buildings if market conditions change to make total occupancy costs important. Finally, retail shopping centers are unlikely to be retrofit beyond a low level of retrofit to the common areas. Owner-occupied large stores are likely to be retrofit within the limits of cash flow, competition and client comfort.

## POTENTIAL FOR RETROFIT IN MARGINAL NEIGHBORHOODS

For owners of both commercial and multifamily buildings in low-income and risky neighborhoods, increases in energy costs create severe economic pressure. Although property taxes and debt service on such properties are low, rents are even lower and there is no cash flow margin to absorb the escalating energy costs. An owner faced with such a situation must choose among a series of bad alternatives: covering the escalating energy costs by undermaintaining the building in other ways, providing inadequate heat and utilities to the building, obtaining enough funds in some way to retrofit the building, or abandoning the building altogether.

There is considerable evidence that rapidly increasing energy costs are the last straw on top of a set of burdens that causes owners to "disinvest" in their buildings. Studies of disinvestment behavior among owners in the South Shore area of Chicago, Cleveland, and Newark explicitly show the importance of energy costs to owners in their ranking of "disinvestment variables" (see table 37). In both 1975 studies, energy costs were ranked as important immediate causes of disinvestment, while in the 1971 study of Newark (before the 1973 oil embargo) energy was not a factor. It is important to note that in the South Shore study, energy cost increases ranked equal to tenant and neighborhood problems. Under the pressure of severe winter demands for regular oil heat deliveries it is easy for a vicious cycle to begin in which the landlord cuts back on heat, or fails to heat the building

altogether, the tenants leave the building or withhold their rent in response, and the landlord finds his income stream drying up. Such vicious cycles have been described by city officials in New York City, Jersey City, and Hartford. The issue of abandonment of housing is discussed further in *Chapter 5: Retrofit for the Housing Stock of the Urban Poor*.

Despite the severe economic pressure caused by energy costs, there are many reasons why owners of commercial and multifamily buildings in marginal neighborhoods are unlikely to retrofit their buildings. The most important of these is that owners are reluctant to "throw good money after bad" if the property has little cash flow, if tenants and market rents in the area will not support recovery of costs, and if neighborhood conditions do not promise at least stable property values. The problem is a little different in revitalizing neighborhoods where owners, expecting future improvement in property values, may defer minor improvements until they are ready to make a major investment or until they sell to another owner for rehabilitation.

It is unlikely that owners of buildings in declining neighborhoods will be able to raise rents to recover energy retrofit costs. Such owners also face much more severe financing problems apart from the economics of their buildings. Historically, lenders have tended to limit their role in such areas because of their

**Table 37.—Landlords' Ranking of Reasons for Disinvestment**

| South Shore<br>Chicago, 1975(1a)               | Cleveland, 1975(2 <sup>b</sup> ) | Newark, 1971(2 <sup>b</sup> ) |
|--|----------------------------------|-------------------------------|
| Energy cost increases                          | Tenants                          | Tax level                     |
| Tenants <sup>a</sup>                           | Neighborhood problems            | Neighborhood problems         |
| Neighborhood problems <sup>a</sup>             |                                  | Tenants                       |
| Maintenance                                    | Energy cost <b>increases</b>     | Building inspection           |
| Tax level                                      | Building inspections             | Mortgage costs                |
| Insurance                                      | Tax level                        | Insurance                     |
| Janitorial costs                               | Insurance                        |                               |
| Lack of housing programs<br>and bank financing |                                  |                               |

<sup>a</sup>Ranked equally.

SOURCES: 1<sup>a</sup>) Management Firm Interviews, 10 sample properties from Robert Giloth, *Disinvestment in South Shore's Large Rental Properties*, June 1978.

2<sup>b</sup>) Real Estate Research Corp. *Real Estate Review*, spring 1976, p. 65.

perception of high risks. Both strict qualifying terms and higher rates are often used to discourage borrowing. Insurance rates for housing or commercial structures in marginal areas have likewise been very high; coverage often is available only through high risk pools.

Typically owners of properties in such marginal areas may be unable to afford to service new debt and if they refinance, it is often to convert long-term equity into cash. Because they lack access to more conventional financing, such owners often have to buy and sell using extra-institutional personalized securities, such as contract-for-deed and seller/purchaser money

mortgages. This makes investments in improvements all the more costly and risky.

In short, energy conservation retrofit in marginal areas is part of the broader issue of rehabilitation and reinvestment in marginal neighborhoods. Simply because energy costs are the “last straw” does not mean that energy-caused disinvestment is inevitable. If a particular owner would have otherwise retained the property, if the neighborhood is stable or revitalizing, or if significant public actions are under way to stabilize the area, it may be possible to facilitate investment in energy conservation.

## POTENTIAL FOR INCREASING THE RATE OF RETROFIT BY BUILDING OWNERS

Some buildings are relatively easy to retrofit; some buildings can be retrofit only with considerable difficulty and expense. As has been clear from this chapter some owner types are willing to retrofit their buildings even at considerable expense; others are not motivated to install even low-cost energy conservation retrofits. The likely pace of retrofit for a particular building, whether rapid or slow, depends on both the building’s physical characteristics and on the resources and motivation of its owner.

The significant differences among physical characteristics of buildings are summarized in table 38 based on the extensive analysis in chapter 3. Buildings for which substantial energy savings are available for low capital cost (less than 2-year payback) include all types of small framehouses, moderate or large multifamily buildings with central air or water systems and commercial buildings except those with central water systems and window air-conditioners. On the other hand, retrofits of moderate capital cost compared to savings (2 to 7 years payback) are required for substantial savings in small masonry rowhouses, moderate or large multifamily buildings with decentralized heating and cooling systems and commercial buildings with central water systems and window air-conditioners.

Given these physical types of buildings and the owner types discussed in this chapter it is possible to classify buildings into those that are very likely to be retrofit, those that are moderately likely and those that are very unlikely. Sooner or later the market will take care of a building that can be retrofitted at low capital cost by an owner who is strongly motivated to retrofit. The prospects are dim indeed for a building that requires moderate capital cost investments for any substantial energy savings by an owner who is unwilling to retrofit.

**Small Multifamily Buildings.** Three owner types and two physical types can account for a large share of the small multifamily buildings in U.S. cities (see table 39). The most likely small multifamily building to be eventually retrofitted for improved energy efficiency is the owner-occupied frame building with a central air or water system. Such buildings are common in all New England cities, and many cities elsewhere in the United States. The long-term perspective of the owner and his need to pay his own energy costs, coupled with the relatively low cost and ease of insulating such buildings and improving the efficiency of their heating systems all make it likely that market incentives will eventually bring about a retrofit.

**Table 38.—Thirteen Types of Buildings With Significantly Different Retrofit Options<sup>a</sup>**

| Building type and wall type                                    | Mechanical system type            | Retrofit options predominantly |                                    |
|--|-----------------------------------|--------------------------------|------------------------------------|
|  |                                   | Low capital Cost <sup>b</sup>  | Moderate capital Cost <sup>c</sup> |
| Small house with frame walls (single family or 2-4 units)      | Central air system                | X                              |                                    |
|  | Central water system <sup>d</sup> | X                              |                                    |
|  | Decentralized system              | X                              |                                    |
| Small rowhouse with masonry walls (single family or 2-4 units) | Central air system                |                                | X                                  |
|  | Central water system              |                                | X                                  |
|  | Decentralized system              |                                | X                                  |
| Moderate or large multifamily building (masonry or clad walls) | Central air system                | X                              |                                    |
|  | Central water system              | X                              |                                    |
|  | Decentralized system              |                                | X                                  |
| Moderate or large commercial building (masonry or clad walls)  | Central air system                | X                              |                                    |
|  | Central water                     |                                | X                                  |
|  | Complex reheat system             | X                              |                                    |
| Same   | Decentralized system              | X                              |                                    |

<sup>a</sup>See ch. 3 for a discussion of retrofit options.

<sup>b</sup>Compared to savings. See ch. 3 for a definition, Approximately defined as retrofits with a 2-year payback Or less.

<sup>c</sup>Compared to savings, Approximately defined as retrofits with a 2-to 7-year payback.

<sup>d</sup>OTA's assumption is that this building type has a central water system and air-conditioners.

SOURCE: Office of Technology Assessment.

**Table 39.—Typology of Small Multifamily Buildings According to the Likelihood of Major Improvement in Energy Efficiency**

| Owner type/<br>meter type     | Building type | Likelihood of major improvement in energy efficiency | Owner's willingness to invest in retrofit | Retrofit options predominantly |                                    |
|-------------------------------|---------------|--|---|--------------------------------|------------------------------------|
|                               |               |  |   | Low capital Cost <sup>a</sup>  | Moderate capital Cost <sup>a</sup> |
| Owner-occupant                | Frame type    | Moderate   | Willing—<br>low capital cost only         | x                              |                                    |
| Owner-occupant                | Masonry wall  | Unlikely   | Willing—<br><b>low</b> capital cost only  |                                | x                                  |
| Absentee owner master-metered | Frame wall    | Unlikely   | Unwilling                                 | x                              |                                    |
| Absentee owner master-metered | Masonry wall  | Unlikely   | Unwilling                                 |                                | x                                  |
| Absentee owner tenant-metered | Frame wall    | Unlikely   | Very unwilling                            | x                              |                                    |
| Absentee owner tenant-metered | Masonry wall  | Very unlikely  | Very unwilling                            |                                | x                                  |

<sup>a</sup>Compared to savings.

SOURCE: Office of Technology Assessment.

The least likely building to be retrofit is the fully tenant-metered masonry-walled rowhouse owned by an absentee landlord. Such buildings are the dominant form of urban housing in the Middle Atlantic States and are also quite common in cities of the Southeast. Usually moderate paybacks are required for substantial savings in such buildings. With tenant metering, absentee landlords under most circumstances have no incentive to retrofit them, regardless of the payback.

Owner-occupied masonry-walled buildings and absentee-owned frame buildings are intermediate cases, the former because retrofit is fairly expensive, offering only moderately fast payback and the latter because the owner is likely to be fairly unwilling to retrofit even with low capital cost measures offering a fast payback. Both of these categories might be susceptible to private or public programs which reduce the risk and financing cost of retrofit.

**Large Multifamily Buildings.** Two physical types and three owner types can explain much of what is likely to happen in the retrofit of large multifamily buildings (see table 40). The most likely buildings to be retrofit are the relatively rare buildings with central air or water heating

systems owned by institutions such as pension funds or insurance companies. (As explained earlier in the chapter, institutions are trying to reduce their holdings of multifamily property or at least to give preference to tenant-metered buildings.) The least likely to be retrofit are large buildings with tenant-metered decentralized systems owned by individuals or local partnerships. Such buildings can be retrofit only if owners are willing to accept moderate paybacks. Under current conditions of capital cost and retrofit uncertainty such owners are willing to invest only in retrofits of very low capital cost with very fast paybacks.

Between the extremes, decentralized buildings owned by condominiums and institutions are only moderately likely to be retrofit because of the expense. Central system buildings owned by individuals and local partnerships may offer opportunities for substantial retrofit but such owners generally require extremely fast paybacks.

**Small Commercial Buildings.** Four combinations of owner and physical types can characterize most small commercial buildings (see table 41). Most of such buildings in cities have masonry or curtain walls which are expensive to in-

**Table 40.—Typology of Large Multifamily Buildings According to the Likelihood of Major Improvement in Energy Efficiency**

| Owner type/<br>meter type                            | Building<br>type                  | Likelihood<br>of major<br>improvement in<br>energy efficiency | Owner's<br>willingness<br>to invest<br>in retrofit | Retrofit options<br>predominantly   |  |
|--|-----------------------------------|---|--|-------------------------------------|--|
|  |                                   |   |  | Low<br>capital<br>Cost <sup>a</sup> | Moderate<br>capital<br>Cost <sup>a</sup> |
| Institution<br>master-metered                        | Central air or<br>water<br>system | Very likely   | Very willing                                       | X                                   |  |
| Institution<br>tenant-metered                        | Decentralized<br>system           | Likely  | Willing  |                                     | x  |
| Condominium<br>master-metered                        | Central air or<br>water<br>system | Likely  | Willing—<br>low capital<br>cost only               | x                                   |  |
| Condominium<br>tenant-metered                        | Decentralized<br>system           | Unlikely  | Willing—<br>low capital<br>cost only               |                                     | x  |
| Individual or small<br>partnership<br>master-metered | Central air or<br>water<br>system | Moderate  | Willing—<br>low capital<br>cost only               | x                                   |  |
| Individual or small<br>partnership<br>tenant-metered | Decentralized<br>system           | Very unlikely   | Unwilling  |                                     | X  |

<sup>a</sup>Compared to savings.

SOURCE: Office of Technology Assessment

**Table 41.—Typology of Small Commercial Buildings According to the Likelihood of Major Improvement in Energy Efficiency**

| Owner type     | Building type                                   | Likelihood of major improvement in energy efficiency | Owner's willingness to invest in retrofit | Retrofit options predominantly |                                    |
|----------------|---|--|---|--------------------------------|------------------------------------|
|                |   |  |   | Low capital Cost <sup>a</sup>  | Moderate capital Cost <sup>a</sup> |
| Owner-occupant | Air system or decentralized system <sup>b</sup> | Moderate   | Willing—low capital cost only             | X                              |                                    |
| Owner-occupant | Water system <sup>c</sup>                       | Unlikely   | Willing—low capital cost only             |                                | X                                  |
| Absentee owner | Air system or decentralized system <sup>a</sup> | Unlikely   | Unwilling                                 | x                              |                                    |
| Absentee owner | Water system <sup>b</sup>                       | Very unlikely  | Unwilling                                 |                                | x                                  |

<sup>a</sup>Compared to savings.<sup>b</sup>Electric resistance baseboard heat and window air-conditioners. See ch. 3.<sup>c</sup>Water or steam central heat and window air-conditioners. See ch. 3.

SOURCE: Office of Technology Assessment.

**sulate. Retrofit opportunities** are limited to heating and cooling systems and lighting. Most small commercial buildings are owned by an individual or local partnership.

The most likely building type to be retrofit is occupied by its owner and has a central air heating and cooling system or decentralized heating and cooling. Such owners are willing to invest in low capital cost retrofits because the energy savings can directly increase their business profits. Buildings with central air systems or decentralized heating and cooling can achieve substantial energy savings with retrofits of low capital cost.

The least likely building to be retrofit is owned by an absentee owner and has a water or steam heating system and window air-conditioners requiring at least moderate capital investment for substantial energy savings. Individual or local partnership absentee owners, short of cash and with little access to good information on retrofit potential, are very unlikely to retrofit, but instead will try to avoid the burden of energy costs by passing them on to tenants using net or passthrough leases.

**Large Commercial Buildings.—Due** to the greater variety of owner types, six combinations of owner type and physical type are necessary to explain much of the predicted variation

among large commercial buildings (see table 42). There are many opportunities for low capital cost retrofits among commercial buildings with central air systems, complex reheat systems, or decentralized systems; if they are owned by owners with long holding periods—corporate owner-occupants or institutional investors—it is likely that retrofit has already occurred.

On the other hand, older commercial buildings with central water or steam systems and window air-conditioners are fairly expensive to retrofit. If such buildings are owned by individuals or local partnerships with short holding periods, constraints on cash flow and poor access to financing and information, they are very unlikely to be retrofit. Other large commercial buildings fall between these extremes either because they are fairly difficult to retrofit or because their owners are unwilling to undertake retrofit regardless of the payback.

As with all simplifications, readers should avoid applying the categorization described above to any particular building. Any given building may easily have prospects quite different from these for quite individual reasons. These categories are to help distinguish the buildings most likely to be retrofit from those least likely and identify the large group in the

**Table 42.—Typology of Large Commercial Buildings According to the Likelihood of Major Improvement in Energy Efficiency**

| Owner type/<br>meter type                                   | Building<br>type                                     | Likelihood<br>of major<br>improvement in<br>energy efficiency | Owner's<br>willingness<br>to invest<br>in retrofit | Retrofit options<br>predominantly   |  |
|---|--|---|--|-------------------------------------|--|
|   |  |   |  | Low<br>capital<br>Cost <sup>a</sup> | Moderate<br>capital<br>Cost <sup>a</sup> |
| Owner-occupant<br>or institutional<br>investor <sup>b</sup> | Air, complex<br>reheat or<br>decentralized<br>system | Very likely   | Very willing                                       | X                                   |  |
| Owner-occupant<br>or institutional<br>investor              | Water system   | Likely  | Very willing                                       |                                     | X  |
| National partner-<br>ship or develop-<br>ment company       | Air, complex<br>reheat or<br>decentralized<br>system | Likely  | Willing—<br>low capital<br>cost only               | X                                   |  |
| National partner-<br>ship or develop-<br>ment company       | Water system   | Moderate  | Willing—<br>low capital<br>cost only               |                                     | X  |
| Individual or local<br>partnership                          | Air, complex<br>reheat or<br>decentralized<br>system | Unlikely  | Unwilling  | X                                   |  |
| Individual or local<br>partnership                          | Water system   | Very unlikely   | Unwilling  |                                     | X  |

<sup>a</sup>Compared to savings.  
<sup>b</sup>E.g. pension fund, insurance company.

SOURCE: Office of Technology Assessment

middle which are most likely to be influenced by aggressive marketing and outreach by private sector entrepreneurs or public sector programs.

Buildings that are likely to be retrofit within current private sector practices include:

- Large commercial buildings with central air, complex reheat or decentralized heating and cooling systems owned by corporations, other large owner-occupants, institutional owners, national partnership syndicates, and development companies.
- Large master-metered multifamily buildings owned by institutional owners and national syndicates.
- Small owner-occupied commercial buildings with central air or decentralized heating and cooling systems.

Buildings which are very unlikely to be retrofit

due both to owner unwillingness and difficulty of retrofit include:

- Small masonry walled multifamily buildings by absentee owners.
- Large tenant-metered multifamily buildings owned by individuals or local partnerships.
- Small commercial buildings owned by absentee owners.
- Large commercial buildings with central water or steam heat and window air-conditioners owned by individuals or local partnerships.

All of the other building types have prospects for retrofit that are less than very likely and more than very unlikely. Whether they are actually retrofit will depend in part on the owner's knowledge of retrofit opportunities and the risk of retrofit and also on the owners access to financing, Each of these is discussed below.

## INFORMATION: DIMINISHING THE RISKS OF RETROFIT

For all building types, in all locations, a major constraint on investment is the uncertainty about the performance of energy conserving measures. Except for a few small studies there is almost no data on the actual performance of retrofits. This is especially true for buildings other than single-family houses.

This lack of information is a substantial barrier to retrofit for smaller owners who lack the technical capacity to evaluate conservation alternatives and the financial wherewithal to experiment. For smaller operators—the dominant group of real estate owners—there is not enough leeway in a building’s cash flow to be able to afford a costly mistake. And although larger owners have resources at their disposal they also want to be very sure that energy conservation is indeed the best use of their investment funds. The most sophisticated owners with the best engineering staffs at their disposal said in interviews that they test the equipment first to establish its performance in actual applications. They reported that much of the experience with these tests has not matched either manufacturers’ or official expectations owing to the effects of previous measures or operational limitations.

Building owners who have installed retrofit measures report mixed results. In a 1979 survey by Booz Allen of apartment building owners, only half the owners, who had installed energy efficiency measures, were satisfied that insulation and furnace modifications were effective measures and only a third were satisfied that weatherstripping was effective (see table 43).

In the most comprehensive survey of documented retrofits done to date, (described in ch. 3) researchers Ross and Whalen obtained data on retrofit results in 222 buildings.<sup>16</sup> Their data illustrates the uncertainty of predicting savings from a retrofit:

- . 10 percent of the buildings failed to have any savings at all.
- . Although those buildings which saved energy saved an average of 22 percent, the

<sup>16</sup>Ross and Whalen, op. cit.

**Table 43.—Percentage of Apartment Building Owners Who Perceived Measures They Installed To Be Effective**

| Measure installed                           | Percentage of owner-installers perceiving the measure to be effective <sup>a</sup> |
|---|--|
| Insulation . . . . .                        | 54/0   |
| Furnace modification . . . . .              | 50   |
| Individual metering or submetering. . . . . | 43   |
| Storm windows . . . . .                     | 39   |
| Clock thermostats. . . . .                  | 38   |
| Weatherstripping . . . . .                  | 31 %   |

<sup>a</sup>The Sum of the percentages is greater than 100 because owners could identify more than one measure as being effective.

SOURCE. National Apartment Association Survey and Booz, Allen & Hamilton, op. cit., exhibit D-6.

savings ranged (within a standard deviation) from **7 to 37 percent.**

- For 60 buildings for which predictions of savings were available as well as savings, there was a substantial difference between predicted and actual savings. Sometimes savings were much better than predicted (a group of schools in Maine), sometimes they were much worse (another group of schools) and sometimes they varied widely within a similar group of buildings (a group of community centers in Columbia, Md.).
- For 15 buildings, with more than 1 year’s data after the retrofit, 60 percent saved more in the years following the first year after the retrofit, but 40 percent saved less.

On the other hand, the Ross and Whalen survey is evidence that, on average, energy retrofit brings a large return on investment. For 65 buildings with good retrofit cost data, almost half had paybacks of less than 1 year. All but seven had paybacks of 3 years or less.

To be effective, information on actual retrofits is most useful when available through the channels which building owners turn to for advice. One of the best are trade associations, The program referred to earlier between DOE and the American Hotel & Motel Association to retrofit and document six different types of buildings is an excellent example. Restaurant trade associations might be able to do the same kind of



testing in conjunction with various restaurant chains. Another possible channel is the local chamber of commerce which might cooperate with local energy retrofit businesses to make information available on documented retrofits.

**Impact of Risk on Building Owner's Payback Preferences.** For many reasons discussed in this chapter some owner types, especially individuals and small partnerships, cannot tolerate large cuts in the cash flow from their buildings. The next section illustrates the cash flow cuts caused by retrofits with moderate paybacks of 6, 7, and 9 years. Given the uncertainty of attaining audit predictions of savings, such owners must avoid moderate payback retrofits because of the risk that they will turn into very long payback retrofits with devastating impact on the building's cash flow.

Table 44 illustrates the impact of predictable deviations in savings from audit results. A 5-year payback retrofit will become a 17-year payback retrofit if actual savings are **70** percent below predicted, a figure perfectly consistent with the comparison of audits and actual savings above. A building owner unable to cope with an actual payback longer than 3 years must avoid all promised paybacks longer than 1 year, if he wishes to allow for the risk that savings might be 70 percent less than predicted.

Improved private sector or public sector information on retrofits could reduce the likely risk that actual savings would be less than audit

**Table 44.—impact of Uncertainty on Expected Annual Energy Savings From a Retrofit Costing \$10,000**

|                                 | Annual savings | Expected payback |
|---------------------------------|----------------|------------------|
| <b>Case 1: 3-year payback</b>   |                |                  |
| Predicted by an audit . . . . . | \$ 3,300       | 3 years          |
| 50% below prediction . . . . .  | 1,650          | 6 years          |
| 70% below prediction . . . . .  | 990            | 10 years         |
| 50% above prediction . . . . .  | 4,950          | 2 years          |
| <b>Case 2: 5-year payback</b>   |                |                  |
| Predicted by an audit . . . . . | \$ 2,000       | 5 years          |
| 50% below prediction . . . . .  | 1,000          | 10 years         |
| 70% below prediction . . . . .  | 600            | 17 years         |
| 50% above prediction . . . . .  | 3,000          | 3½ years         |
| <b>Case 3: 1-year payback</b>   |                |                  |
| Predicted by an audit . . . . . | \$10,000       | 1 year           |
| 50% below prediction . . . . .  | 5,000          | 2 years          |
| 70% below prediction . . . . .  | 3,000          | 3½ years         |
| 50% above prediction . . . . .  | 15,000         | 8 months         |

SOURCE Office of Technology Assessment

predictions. As table 44 shows, for an owner unable to tolerate more than a 5-year payback, an improvement in downside risk from 70 percent to 50 percent will allow that owner to make a predicted 3-year payback investment.

Better documentation of safe retrofits which reduces the risk of a retrofit would be of most use to cash-starved individual owners and small partnerships. With reliable information in hand, they might be willing to consider retrofits with paybacks beyond the strict 1-year payback they now insist on.

## IMPACT OF LESS COSTLY FINANCING ON THE PACE OF RETROFIT

For some building types, long-lasting retrofits are available which will, if successful, earn substantial returns in improved net income and building resale value over the life of the measure. Two such measures are installing more efficient air-conditioners in a large building with cooling from window air-conditioners, and replacing the roof of a flat-roofed building and adding roof insulation. Such measures would not be expected to payback for 6 to 10 years. Since they will last 20 years or more, however,

both would be sound long-term investments for a building.

A major obstacle to making such investments attractive to many building owners without internal sources of funds is the high cost of debt service in the early years as a result of the tradition of amortizing loans in equal annual payments of interest and principal repayments.

**Simple Relationship Between Debt Service and Payback.** Without examining all the com-

plexities of real estate finance with depreciation schedules and tax deductions of energy costs and interest, it is useful to examine the simple relationship between debt service and energy retrofit payback, shown in figure 38. For energy retrofits with a 2-year payback, there are many combinations of interest rate and loan term that would allow energy savings to exceed the cost of borrowed money the first year. The financing options are far fewer for a retrofit with a 5-year payback. Only 10-year loans at interest rates of less than 10 percent per year or 20- or 30-year loans with interest rates as high as 18 percent

would keep debt service costs the first year below energy savings.

For most building owners interviewed who lacked access to internal funds for retrofits, the only option for borrowing money was a commercial loan at 2 points over the prime rate (which in the summer of 1980 and the spring of 1981 was 21 percent). The best available outside financing mentioned was a 5-year loan at 16 percent.

Given such financing options, especially with the very short terms of loans available from

**Figure 38.-Combinations of Loan Terms and Interest Rates Which Allow the Value of Energy Savings to Exceed the Cost of Borrowed Money the First Year**

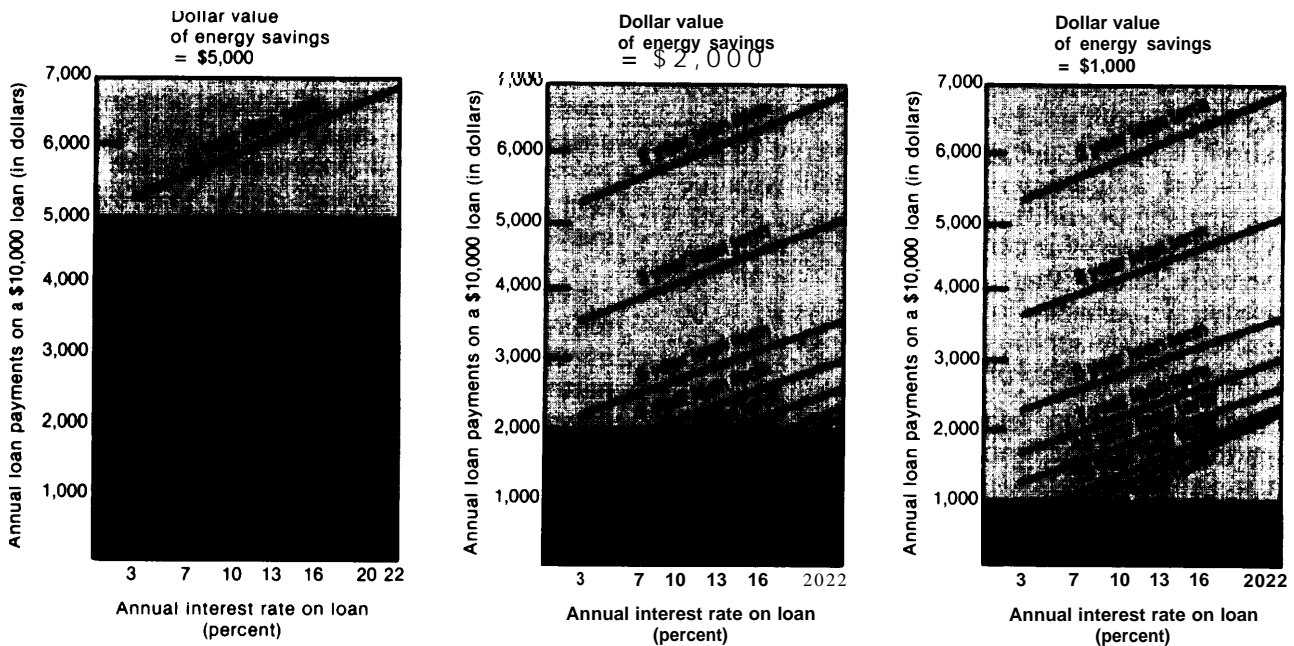

**Case 1: Energy savings from a 2 year payback retrofit (maximum payback considered by an individual or local partnership owner)**

**Case 2: Energy savings from a 5 year payback retrofit (criteria used by corporations, insurance company owners)**

**Case 3: Energy savings from a 10 year payback retrofit (maximum payback criteria of any owner interviewed)**

Key:

- Cash flow *loss* the first year
- Cash flow *increase* the first year

commercial banks (often less than 2 years), it is not surprising that only 2 of the 33 major building retrofits reported in the building owner interviews were financed through outside borrowing. All the rest were funded from internal capital resources. It furthermore is no surprise that a building owner, without internal funding and with limits on the extent to which he can cut into a building's cash flow, would limit consideration of retrofits to those with short paybacks of 1, 2, or 3 years.

The term of a loan matters more than the interest rate in reducing annual debt service costs below energy savings. For retrofits with long lifetimes such as new boilers, air-conditioners, new lighting fixtures, or new insulation all of which should be expected to last 20 years or more, building owners might well accept fairly long-term financing, even at moderate to high interest rates, if it were available.

Unfortunately, two programs that help make long-term property improvement loans available to single-family homeowners have not been available to owners of multifamily or small commercial buildings. Title 1A loan insurance has helped stimulate 7- to 10-year property improvement loans for single-family homes (1 to 4 units) since World War II. However, its companion program, title IB, for multifamily buildings has been very little used. Similarly, the Federal Home Loan Mortgage Corporation launched in 1981 a pilot program to purchase home improvement loans for single family homes from savings and loan associations. The loans must be secured by a second trust and may be on amounts up to \$30,000 and have terms of up to 15 years. There are no plans to create a secondary market for property improvement loans for multifamily or commercial buildings.<sup>17</sup>

**Adding Complications: Return on a Retrofit for a Prototypical Building.** For a more realistic appraisal of the impact of a retrofit on particular buildings, OTA developed information on six prototypical buildings from published average

<sup>17</sup>The information in this paragraph is based on presentations by Michael Ehrman of HUD and Mark Shaefer of the Federal Home Loan Mortgage Corporation at a community energy workshop meeting on financing held at HUD on Oct. 29, 1981.

expense and income data in particular localities as well as appraisal data.<sup>18</sup> The prototypes illustrate some of the variations in income and expenses in multifamily buildings: large and small, master and tenant metered, low rent structure, and moderate rent structure.

For one such building analyzed, a medium small building with 18 units, in a cold climate typical of St. Paul, Minn., but in a moderate rent area where both rental income and taxes are substantial, a specific retrofit investment was simulated. It was a fairly large package of retrofit measures, costing \$22,303 or \$1.45 per square foot. It saved 30 percent of the buildings energy use or about \$2,500 the first year. Such a retrofit would be typical for a masonry-walled building for which wall and roof insulation is expensive, and would payback in 9 years, well beyond the planning horizon of the building owners interviewed for this study.

There would be substantial benefits to the owner from such a retrofit. After all tax benefits from interest and depreciation were taken into account there would be a substantial increase in net income from the building.

|                           | <i>First year</i> | <i>Fifth year</i> |
|---------------------------|-------------------|-------------------|
| Energy savings.....       | \$2,500           | \$4,480           |
| Increased net income..... | \$1,459           | \$4,452           |

such an increase in a building's net income should be translated directly into increased resale value for the property, if general economic conditions for the building remain the same. For a building in a stable neighborhood with the moderate rent structure described above, an appraiser would capitalize the net income at 9½ or 10 times in order to assess the building's resale value (see box E above). After 5 years such a building should have an increased resale value more than \$40,000 higher than with no retrofit.

|  |            |
|--|------------|
| Fifth year value without retrofit..... | \$402,133  |
| Fifth year value with retrofit.....    | \$442,601  |
| Increased value.....                   | + \$40,468 |
| Percent increase in value.....         | + 10.4%    |

Such an increase in value would be almost double the cost of the retrofit.

<sup>18</sup>A description of the methods used to analyze the prototypical buildings and presentation of the results will be published in working papers to this report.

Although there are clear long-term benefits to the owner of such a building from undertaking a retrofit with a fairly long payback, there are serious short-term reductions in the building's cash flow as a result of the high cost of conventional debt service. If the retrofit is paid for with a 16 percent 5-year loan (which was the most favorable conventional financing available to any building owner interviewed) there is a sharp drop in cash from building operations from the first year all the way through the fifth year (see fig. 39). If the building owner survives until the sixth year, debt service to pay for the retrofit ends and the increase in net income is completely retained.<sup>19</sup>

**Subsidy Options. Given** the loss in building cash flow from a substantial retrofit financed with a 16-percent interest loan, **OTA compared the impact of two different financing subsidies on the building's cash flow.** The two subsidies, one a tax credit and the other a financing sub-

<sup>19</sup>For a discussion of the impact on cash flow of an even longer payback solar retrofit see Arthur J. Reiger, "Solar Energy: The Market Realities," *Real Estate Review*, vol. 8, winter 1979.

**Figure 39.—Cash From Operations<sup>a</sup> for an 18-Unit Apartment Building With and Without an Energy Retrofit<sup>b</sup>**

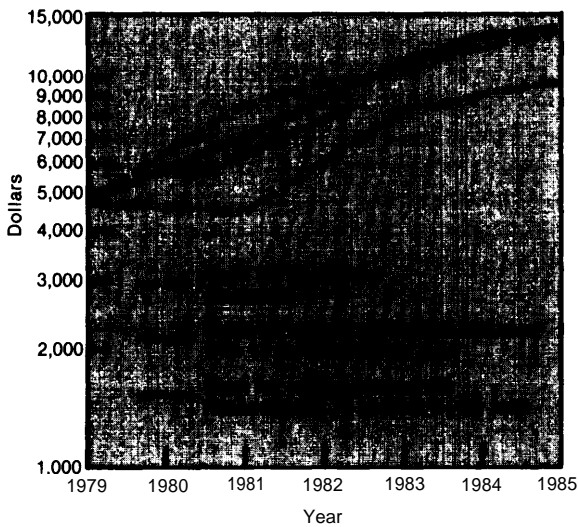

<sup>a</sup>Pre-tax while functioning as a tax shelter and after tax once it starts generating an after-tax profit.  
<sup>b</sup>Retrofit costing \$22,300 with about a 9-year payback.

SOURCE: Office of Technology Assessment.

sidy, are of comparable cost to the Treasury. The first of these is a tax credit of 30 percent that OTA (somewhat arbitrarily) defined as substituting for the first 30 percent of depreciation taken on the retrofit. The cost to the Treasury of such a subsidy would be \$6,690 the first year but it would be offset over the first several years by a reduction of the same amount in depreciation deductions. For building owners in the 50-percent income tax bracket such a depreciation deduction would be worth \$3,345 over several years of depreciation deduction. Thus, the net tax loss is only half of the \$6,690 or 15 percent of the retrofit cost.

The other subsidy, of approximately equal or slightly less cost, is a loan subsidy designed both to reduce the effective interest rate on the retrofit loan and to increase the loan term. The interest rate subsidy is straightforward. A lump-sum payment of about \$2,200 deposited in a bank in the first year of a loan is the present value equivalent of a reduction in interest from 16 to 13 percent and an increase in loan term from 5 to 10 years. This amount is only about 10 percent of the cost of the retrofit. A significantly larger subsidy, however, would be needed to actually induce banks to increase loan terms. This could take the form of loan insurance (about 2 percent of a loan's value) and administrative and financial support for a secondary market for retrofit loans. For this reason OTA estimates the total cost as comparable to the 15 percent of retrofit cost for the net impact of the tax credit.

The impact of the two subsidies is compared in figure 40. The tax credit restores or slightly increases aftertax cash flow the first year but leaves a large reduction in the pretax cash flow. The fifth year, however, both pre and aftertax cash flow are reduced from their no retrofit level. With the loan subsidy, the building's pretax and aftertax cash flow are both slightly reduced the first year from the no retrofit situation, but by the fifth year, both pretax and aftertax cash flow exceed the no retrofit situation.

**Impact of Retrofit on Two Other Prototypical Buildings: Low Rent and Tenant Metered.** Two other prototypical buildings illustrate some

**Figure 40.—Impact of Energy Retrofit Subsidies on Pretax and Aftertax Cash Flow for a Prototypical Apartment Building**

**Building A: 18-units, moderate rent, moderate taxes, master-metered**

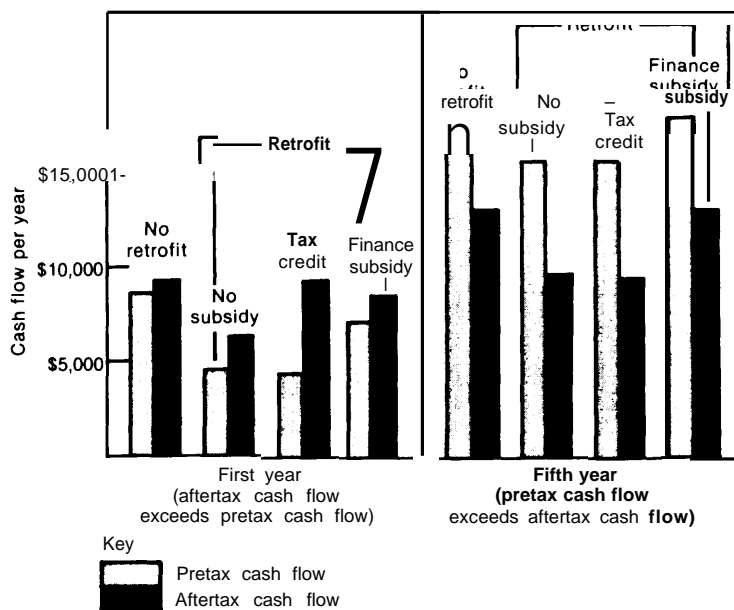

SOURCE: Office of Technology Assessment.

interesting variations on the kind of impacts described above. Both are illustrated in figure 41.

Building B is a small multifamily building with low rents and low taxes and substantial energy costs, based on rent and cost structures found in St. Louis. A retrofit costing \$34,809 is simulated. It saves \$4,979 in energy costs the first year for a simple payback of 7 years. This building has very poor cash flow to begin with. The first year pretax cash flow is essentially wiped out by a retrofit with a 7-year payback. Aftertax cash flow the first year suffers considerable but less damage than pretax cash flow; it is reduced by about half. By the fifth year an unsubsidized retrofit or one subsidized with a tax credit has still reduced aftertax cash flow way below what it would have been. A retrofit with a financing subsidy on the other hand has increased both the building's pretax and aftertax cash flow. Although a retrofit is very damaging to this building's cash flow, it also has a very beneficial impact on its resale value which increases by almost 27 percent.

Building C (also shown in fig. 41) is at the opposite extreme from building B. This large building is tenant metered with moderate rents and taxes based on income and cost structures found in Tampa, Fla. The owner makes a retrofit only to save on energy costs in the common areas, which are a small fraction of building expense. The energy retrofit costs the owner \$41,794 and saves \$6,975 in energy costs the first year for a simple payback of 6 years. Such a retrofit is neither very important to the building's resale value which increases by only 3.9 percent, nor is it very important to the buildings pretax or aftertax cash flow which does not change much with either an unsubsidized or subsidized retrofit. Such a building has adequate cash flow to cover this retrofit easily.

A conclusion to be drawn from this comparison of prototype analyses is that a retrofit is most beneficial to the overall return of a low-rent building with high energy use but it is also most devastating to its cash flow. Under such circumstances, a financing subsidy (as opposed to a tax

**Figure 41.—Impact of a Retrofit on Pretax and Aftertax Cash Flow for Two Other Prototypical Apartment Buildings**

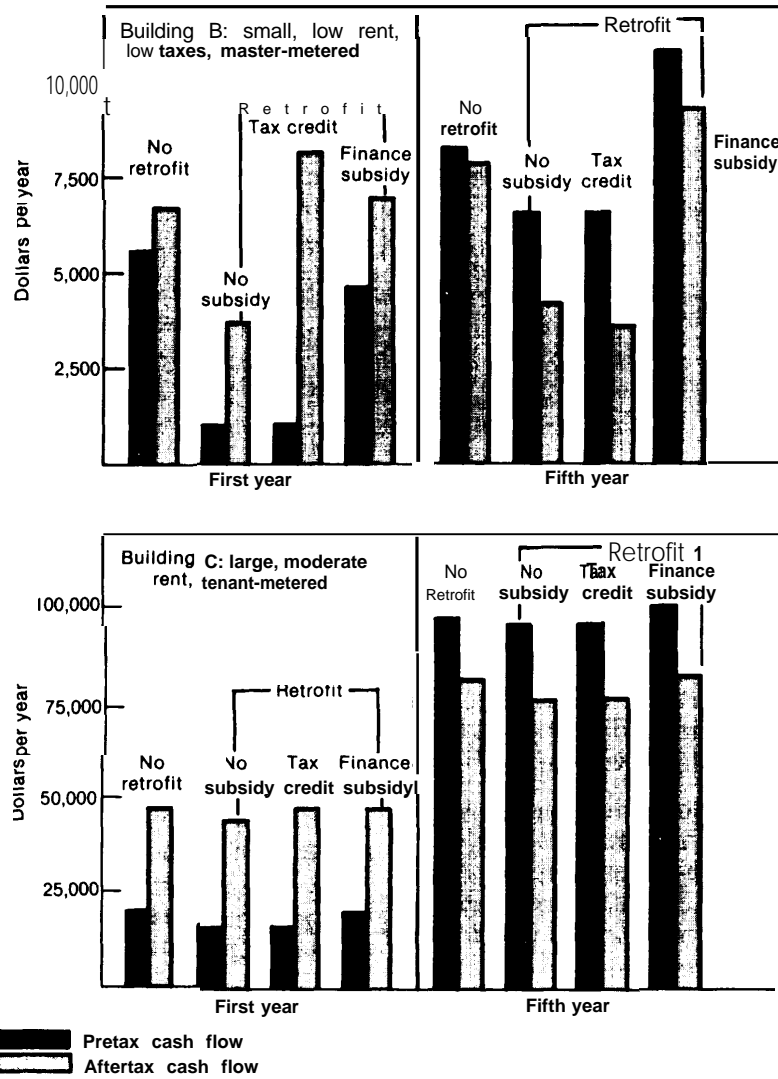

SOURCE: Office of Technology Assessment.

credit) will have a most beneficial impact to prevent sharp cash flow losses the first year and even increase cash flow by the fifth year.

**Building Owners' Preferences for Subsidies.**

Building owners interviewed in the four case study cities preferred subsidized financing of retrofits to a subsidy in the form of a tax credit by a 3 to 1 ratio for reasons that are consistent with the prototype analysis (see table 45). A financing subsidy assists the building's cash flow over several years while a tax credit doesn't

assist the building's cash flow at all the first year and actually decreases the aftertax cash flow after 5 years.

The not quite 25 percent of the building owners interviewed who preferred tax credits, did so because tax benefits were important to them in the return from their real estate holdings. Most of these owners were partnerships. A few were corporations which had adequate internal sources of finance for retrofit but welcomed a tax benefit.

**Table 45.— Building Owner Preferences for Tax Credits or Financing Subsidies**

| Case study city   | Financing    | Tax credit   | Total |
|-------------------|--------------|--------------|-------|
| Buffalo .....     | 18           | 5            | 23    |
| Des Moines .....  | 13           | 3            | 16    |
| Tampa .....       | 7            | 4            | 11    |
| San Antonio. .... | 10           | 3            | 13    |
| Total .....       | 48 (76.20/o) | 15 (23.80/o) | 63    |

SOURCE Office of Technology Assessment

**Summary: Likely Impact of Risk Reduction and Financing on the Pace of Retrofit in City Buildings.** How willing owners are to retrofit their buildings depends on several conditions apart from the ease of retrofitting their buildings:

- Is energy retrofit important to the owners' goals for the building and consistent with them?
- Is the risk of retrofit and the cost of financing it tolerable to the owner?

Owners can crudely be divided into four categories on the basis of the product of these four conditions.

| Owners' access to finance and tolerance of risks      | Importance of reducing energy costs to owners' goals |                      |
|---|--|----------------------|
|   | Important  | Not important        |
| Owner can both finance and absorb risk                | Willing and able                                     | Able but unwilling   |
| owner can't tolerate risk and/or lacks financing..... | Willing but not able                                 | Unwilling and unable |

SOURCE: Office of Technology Assessment.

Public and private programs designed to reduce risk or lower the cost of financing retrofit (a variety of such programs are described in ch. 11) are likely to have the greatest impact on the group of owners who are willing and even anxious to retrofit but who lack the financial flexibility to finance retrofits at reasonable cost and to absorb the costs of a mistake. Such owners include:

- Owner-Occupants of small multifamily buildings.
- Small business owner-occupants of their buildings.
- Individual and small (local) partnership owners of master metered multifamily buildings.

- individual and partnership owners of office buildings in markets that have become sensitive to energy costs.

Programs to reduce risks and/or lower financing costs can take a wide variety of forms, including:

- Private market investment and assumption of risk through leasing or guaranteed savings.
- Private- or public-sponsored programs to test retrofits for specific kinds of buildings, e.g., several current restaurant and hotel programs.
- Financing by private utilities, insurance companies, or any level of government designed to increase loan terms and lower interest rates.
- Tax credits, although these are relatively less helpful to most building owners than the same amount of government money in the form of a financing subsidy.

For building owners who are able to retrofit but not highly motivated to retrofit because it is not consistent with their goals for the building, the long-term operation of the market may eventually have an impact. Such owners include:

- Well-financed owners (such as national syndicates and development companies) of tenant-metered multifamily buildings.
- Well-financed owners of office buildings in tight markets that are insensitive to energy costs.
- Well-financed owners of shopping centers in retail markets that are insensitive to energy costs.

In some governmental jurisdictions there may be political support for requiring energy retrofit for certain categories of these buildings, especially tenant-metered multifamily buildings. Such requirements might be imposed at the time a master-metered building were converted to a tenant metered one, or at the time of sale. In response to such a requirement, well-financed building owners will be able to make the retrofit. Whether they can recoup the investment over time will depend on the nature of the rent structures in the building's market area.

By contrast, building owners who are both unwilling to retrofit and unable to finance or tolerate the risk of a retrofit, are not likely to be able to respond to a requirement to retrofit unless some financing and risk reduction assistance is provided. Such owners include:

- Small individual or partnership investor owners of tenant metered multifamily buildings.
- Small individual or partnership investor owners of retail or office space with net or passthrough leases.
- Owners of buildings in marginal areas.

Any political jurisdiction wishing to speed up the pace of retrofit by regulation of such buildings would have to see to it that financing and risk-reduction assistance were available. It is at

least possible that local private utilities and leasing and energy savings guarantee companies would be active enough in a particular city that no public program would be needed,

Owners of buildings in marginal areas are a special case. For these, retrofit makes sense only in the context of the potential resale value of buildings in the entire neighborhood or district. For such buildings, programs to speed up energy retrofit only make sense in the context of overall rehabilitation programs designed to encourage general owner investment in their buildings (in structure, facade, wiring, plumbing, *and* energy efficiency) and to increase confidence in the area by potential building purchasers and the financing community.



**Chapter 5**

**Retrofit for the Housing Stock  
of the Urban Poor**

# Contents

|  | Page |
|--|------|
| Impact of Residential Energy Costs on Low-Income Households. . . . .             | 144  |
| Energy Efficiency of Low-Income Housing. . . . .                                 | 147  |
| Prospects for Energy Retrofit of Low-Income Housing—Private Efforts. . . . .     | 150  |
| Prospects for Retrofit: Public Housing. . . . .                                  | 154  |
| Federal Programs That Address the Energy Needs of Low-Income Households. . . . . | 156  |
| Direct Cash Assistance. . . . .  | 156  |
| Weatherization . . . . .   | 158  |
| Some Successful Approaches to Retrofit for the Urban Poor. . . . .               | 159  |
| Fitchburg, Mass.; Low Cost/No Cost. . . . .                                      | 159  |
| Philadelphia Burner Retrofit. . . . .  | 161  |

## LIST OF TABLES

| <i>Table No.</i>   | Page |
|--|------|
| 46. Who Are the Poor: Number of Poor Households According to Two Different Federal Standards. . . . .                            | 143  |
| 47 Estimated Annual Household Expenditures on Home Energy by Income Class, 1981 . . . . .  | 145  |
| 48 Estimated Average Household Home Energy Expenditures, by Type of Fuel Used for Heating and Region, Fiscal Year 1981 . . . . . | 145  |

| <i>Table No.</i>  | Page |
|---|------|
| 49. Total Residential Energy Consumption for All Fuels—April 1978 Through March 1979. . . . .   | 146  |
| 50. Energy Efficiency Characteristics of Single-Family Houses Occupied by Low-Income People Compared to All Single-Family Houses. . . . . | 148  |
| 51. Structural Adequacy of Occupied Single-Family Houses by Presence of Energy-Saving Features, 1976 . . . . .                            | 148  |
| 52. Comparison of Increases in Abandoned Buildings With Increases in Energy Costs in Rochester, N. Y.. . . . .                            | 152  |
| 53. Energy Conservation Potential of Public Housing. . . . .  | 153  |
| 54. summary of Low-Income Energy Assistance Programs, Fiscal Years 1977-81 . . . . .  | 157  |

## LIST OF BOXES

|   | <i>Page</i> |
|---|-------------|
| G. Oil Heat: No Cash, No Fuel. . . . .                                | 146         |
| H. Bad Debts. , ., . . . . .  | 147         |
| I. Metering policy: Public Housing. . . . .                           | 154         |
| J. Energy Consciousness in Public Housing: Case Study Cities. . . . . | 155         |

# Retrofit for the Housing Stock of the Urban Poor

Like other buildings, those buildings housing the poor can be retrofit to use far less energy than they now use, at low or moderate capital cost compared to the energy that is saved. The prospect that such retrofit will actually occur, however, depends on an interaction between private means and public purpose that is quite different from the real-estate decisionmaking described in chapter 4. The likelihood of retrofit is affected, on the one hand, by the poorer condition of housing and higher proportion of renters among the housing of the poor and, on the other hand, by the strong public tradition of providing cash and in-kind assistance to low-

income households. Much of the focus of Federal energy policy, as well as part of the focus of State and local energy policy has been on assistance to low-income people in coping with escalating energy costs.

It should be remembered that low-income households range from elderly widows to households with children headed by a single working parent. Large proportions of the poor are not on welfare, do not receive food stamps, are not over 65, and live in the South or West rather than the Northeast or North Central. Table 46 is a useful reminder of *Who Are the*

**Table 46.—Who Are the Poor: Number of Poor Households According to Two Different Federal Standards (in millions)**

|  | Households with incomes below 125 percent of poverty guidelines <sup>a</sup> | Households with incomes below living standard <sup>b</sup> or 125 percent of poverty guidelines |
|--|--|---|
| All households <sup>c</sup>  | 12.3   | 16.2  |
| Public assistance reciprocity <sup>d</sup>   |  |   |
| aid to families with dependent children (AFDC) or supplemental security income (SSI) | 3.5  | 4.1   |
| Food stamps only   | 1.5  | 1.8   |
| Not receiving AFDC, SSI, or food stamps . . . . .                                    | 7.3  | 10.3  |
| Family type: <sup>e</sup>  |  |   |
| Married couple with children   | 2.0  | 3.8   |
| Single-parent female with children   | 2.6  | 3.3   |
| Single-parent male with children   | 0.1  | 0.2   |
| Single persons and couples without children  | 7.6  | 8.9   |
| Age of householder: <sup>f</sup>   |  |   |
| 65 or older  | 4.6  | 5.5   |
| Less than 65   | 7.7  | 10.7  |
| Race of householder:   |  |   |
| White  | 9.1  | 12.3  |
| Black  | 2.9  | 3.6   |
| Other  | 0.2  | 0.3   |
| Census region: <sup>g</sup>  |  |   |
| Northeast . . . . .  | 2.5  | 3.5   |
| North Central . . . . .  | 2.9  | 3.8   |
| South . . . . .  | 4.8  | 6.0   |
| West . . . . .   | 2.1  | 2.9   |

<sup>a</sup>As established by the Office of Management and Budget  
<sup>b</sup>As established by the Bureau of Labor Statistics  
<sup>c</sup>Based on a total of 794 million households in the United States  
<sup>d</sup>AFDC and SSI reciprocity and family type are based on the primary family only  
<sup>e</sup>The householder is defined as the person in whose name the housing unit is owned or rented or if there is no such person, any adult member excluding roomers boarders or paid employees. If the house is owned or rented jointly by a married couple the householder may be either the husband or wife  
<sup>f</sup>Northeast: Maine Vermont New Hampshire Massachusetts Connecticut Rhode Island New York Pennsylvania New Jersey  
North Central: Ohio Michigan Indiana Illinois Wisconsin Minnesota Iowa Missouri Kansas Nebraska South Dakota North Dakota  
South: Maryland Delaware District of Columbia Virginia West Virginia North Carolina South Carolina Georgia Florida Kentucky Tennessee Alabama Mississippi Louisiana Arkansas Oklahoma Texas  
West: Montana Wyoming Colorado New Mexico Arizona Utah Idaho Washington Oregon Nevada California Alaska Hawaii

SOURCES: Census Bureau's March 1980 Current Population Survey and the Congressional Budget Office

Poor whose numbers range from about 12 million to about 16 million households depending on which definition of poverty is being used.<sup>1</sup>

Because of limitations of data this chapter presents primarily information on energy retrofit of low-income housing in the country as a whole and very little information on low-income housing in central cities per se. This does not in any way imply that energy efficiency in low-income housing is not an important concern in cities. All of the case study cities visited by OTA (see ch. 9) had developed policies to deal in some

<sup>1</sup> For a complete treatment of the impact of energy costs on the poor and government options for dealing with this problem see Hans H. Lansberg and Joseph M. Dukert, *High Energy Costs: Uneven, Unfair, Unavoidable?* Johns Hopkins University Press for Resources for the Future, Inc., 1981.

## IMPACT OF RESIDENTIAL ENERGY COSTS ON LOW-INCOME HOUSEHOLDS

On average, low-income families spend a greater proportion of their income on residential energy expenses than do households in higher income brackets. The latest data, assembled by the Congressional Budget Office (CBO) and updated to 1981 from the Department of Energy (DOE) 1978-79 National Interim Energy Consumption Survey (NIECS), show that households earning less than \$7,400 spend 15.2 percent of their income on residential energy. This percentage is almost twice that of the next income group<sup>2</sup> (see table 47). However, there is a sharp variation in what households pay for energy, depending on where they live and the type of fuel they use (see table 48). In 1981, average home energy expenses (for all income classes) varied from \$680 for those heating with natural gas in the West to \$1,690 for those heating with fuel oil or kerosene in the Northeast or North Central.

A study prepared for the city manager's office in Hartford, Conn., gives some sense of the impact of energy prices in a community that relies

<sup>2</sup> Congressional Budget Office, *Low-Income Energy Assistance: Issues and Options*, June 1981, p. 6. Much of the information in this chapter is drawn from this study.

way with energy conservation for low-income people.

From the Federal perspective the most important consideration in energy policy for the poor is how to design sensible low-income assistance programs. In addition, however, buildings occupied by the poor do consume a significant amount of energy, an estimated 2.2 Quads or about 8 percent of total building energy use.

This chapter first describes what is known about the impact of rising energy prices on the poor and what is known about the condition of their housing. It then discusses the private prospects for retrofit and finally the many public programs for retrofit and energy assistance, including those that deal with public housing.

on oil as its heating source.<sup>3</sup> More than half of the households in Hartford are on fixed incomes averaging \$3,700 per year. Year round, a household with an average fixed monthly income of about \$312 (\$3,700 per year) would pay an average of \$96 a month for energy—fuel oil for heat, gas for cooking, and electricity—for a four- to five-room apartment typical of the two- and three-family houses in the Hartford area. During the 5-month winter season the average utility cost of utilities and heat would increase to about \$145 per month. Combined with the average rent of \$150 for such an apartment the total cost of shelter is calculated to use up virtually all (\$295) of the monthly income of a household living on a fixed income. According to the study, the situation would be only a little easier for fixed income households living in apartments of one to three rooms. Exacerbating the strain on low-income households from high energy costs in Hartford are the cash demands from oil heat dealers who are themselves caught in a cash squeeze (see box G).

<sup>3</sup> Christopher Merrow, "The Impact of Rising Energy Costs on the City of Hartford," August 1979 (unpublished report prepared for Greater Hartford Process, Inc., and the Hartford City Manager's Office).

**Table 47.—Estimated Annual Household Expenditures on Home Energy by Income Class, 1981**

|  | Estimated average expenditures on home energy (in dollars) <sup>a</sup> | Percent of income <sup>b</sup> |
|--|---|--------------------------------|
| Estimated household income:                            |   |                                |
| Less than \$7,400 .....                                | \$ 740  | 15.20/o                        |
| <b>\$7,400 to \$14,799. ....</b>                       | <b>880</b>  | <b>7.9</b>                     |
| <b>\$14,800 to \$22,099. ....</b>                      | <b>910</b>  | <b>4.9</b>                     |
| \$22,100 to \$36,899 .....                             | 1,090   | 3.8                            |
| \$36,900 or more .....                                 | 1,290   | 2.5                            |
| Average, all households <sup>c</sup> (not just poor) . | \$1,000   | 4.20/o                         |

<sup>a</sup>Home energy expenditures include fuel oil, kerosene, electricity, natural gas, and liquid petroleum gas expenditures. These expenditures are adjusted from the survey year to 1981 on the basis of estimated energy price changes. The quantity of energy purchased is assumed to decrease by 0.15 percent for each 1 percent increase in the price of energy.

<sup>b</sup>These expenditures are adjusted to 1981 on the basis of CBO economic assumptions. Households with negative total incomes because of self-employment losses are excluded when calculating average incomes.

<sup>c</sup>The NIECS only collected data on a household's income class, such as less than \$3,001, or between \$3,000 and \$5,000 in order to determine a household's poverty status, each household was assumed to have income equal to the midpoint of its income class. For example, a household reporting income between \$3,000 and \$5,000 would be assumed to have income of \$4,000 in order to calculate the ratio of household income to the poverty guideline.

<sup>d</sup>See footnote (f) to table 46 for a list of the States in each region. Table excludes residents of Alaska and Hawaii.

SOURCES: Congressional Budget Office estimates, based on the Department of Energy's National Interim Energy Consumption Survey (NIECS) which covers the 12-month period from April 1978 to March 1979. Income data derived from the Census Bureau's March 1978 Current Population Survey, updated using Congressional Budget Office economic assumptions.

**Table 48.—Estimated Average Household Home Energy Expenditures, by Type of Fuel Used for Heating and Region, Fiscal Year 1981 (in dollars)**

|   | All regions <sup>a</sup> | Northeast | North Central | South  | West   |
|---|--------------------------|-----------|---------------|--------|--------|
| Estimated average home energy expenditure for households heating with: <sup>b</sup> |                          |           |               |        |        |
| Natural gas .....   | \$ 890                   | \$1,080   | \$ 970        | \$ 840 | \$ 680 |
| Fuel oil or kerosene .....  | 1,560                    | 1,690     | 1,690         | 1,240  | 1,160  |
| Electricity .....   | 830                      | 770       | 1,130         | 860    | 660    |
| Liquid petroleum gas (LPG) .....  | 1,030                    | 1,250     | 1,360         | 890    | 1,080  |
| Other .....   | 570                      | 560       | 710           | 580    | 440    |
| Percent of households heating principally with: <sup>c</sup>                        |                          |           |               |        |        |
| Natural gas .....   | 55                       | 41        | 77            | 38     | 68     |
| Fuel oil or kerosene .....  | 19                       | 43        | 13            | 15     | 5      |
| Electricity .....   | 17                       | 10        | 4             | 30     | 18     |
| Liquid petroleum gas (LPG) .....  | 5                        |           |               | 9      | 3      |
| Other .....   | \$ 5                     | \$ 5      | \$ 5          | \$ 7   | \$ 5   |

<sup>a</sup>Table excludes residents of Alaska and Hawaii. See footnote (f) to table 46 for a list of States in each region.

<sup>b</sup>These expenditures are adjusted from the survey year to 1981 on the basis of estimated energy price changes. The quantity of energy purchased is assumed to decrease by 0.15 percent for each 1 percent increase in the price of energy.

<sup>c</sup>As of November 1979.

NOTE: Details may not sum to totals because of rounding.

SOURCE: Congressional Budget Office estimates, based on the Department of Energy's National Interim Energy Consumption Survey, and DOE's 1979 Household Screener Survey.

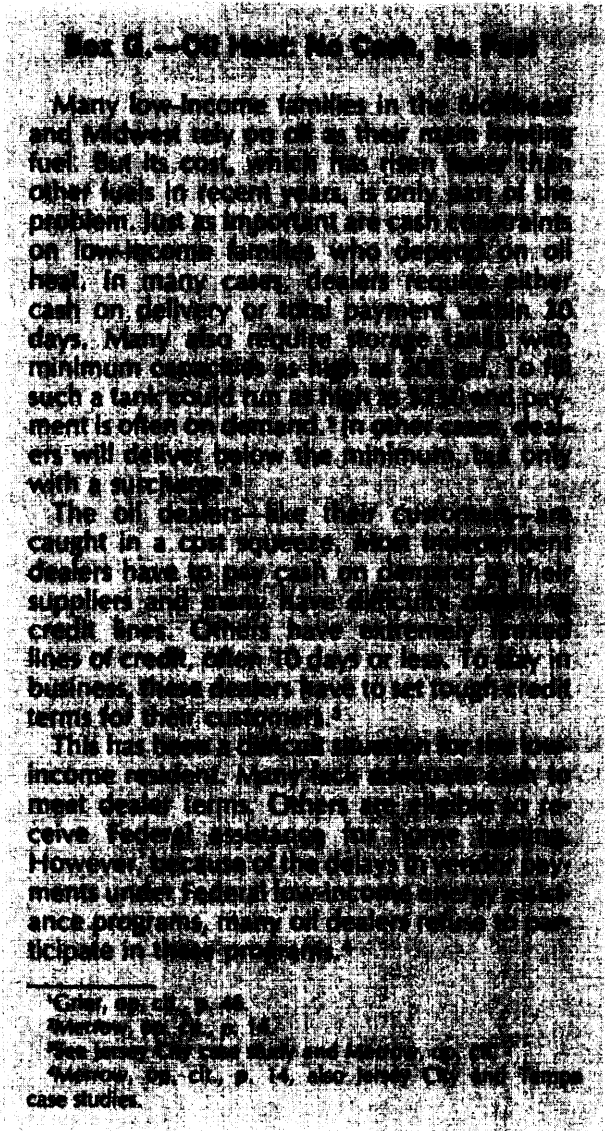

**Table 49.—Total Residential Energy Consumption for All Fuels—April 1978 Through March 1979**

| Income                        | Average amount consumed per household (millions of Btu) |
|-------------------------------|---|
| Less than \$5,000 . . . . .   | 108   |
| \$5,000 - \$9,999 . . . . .   | 124   |
| \$10,000 - \$14,999 . . . . . | 122   |
| \$15,000 - \$19,999 . . . . . | 141   |
| \$20,000 - \$24,999 . . . . . | 153   |
| \$25,000 or more . . . . .    | 176   |
| Total poor . . . . .          | 119   |

SOURCE: Residential Energy Consumption Survey; Consumption and Expenditures April 1978 through March 1979. Department of Energy, July 1980.

tionwide, the poor closed off rooms (26 percent) a little less frequently than did other households (31 percent) in the winter of 1978 -79.4 In St. Paul, in the winter of 1979-80, poor households closed off rooms slightly more (63 percent) than average households (58 percent), but they turned down the thermostat slightly less (85 percent of poor households compared to 87 percent of all households.) In a 1975 survey of five communities in the Southwest, poor families were substantially more likely than high-income families to take steps to conserve energy—such as using less hot water, hanging clothes out to dry, or turning off the thermostat when away from home—that required greater effort or inconveniences

Anecdotal evidence from various studies of energy and the poor, and conversations with housing officials in the case study cities of Buffalo and Jersey City indicate that high heating costs have brought about a "heat or eat" choice for poor families in cold climates, but OTA could find no survey data on changing households' budgets in response to higher energy prices.<sup>6</sup> Another response of poor households

<sup>4</sup>Energy Information Administration, Residential Energy Consumption Survey: *Conservation*, February 1980, p. 35.

<sup>5</sup>These two surveys are described in Bernard J. Frieden, "Household Energy Consumption: The Record and The Prospect," MIT Program on Neighborhood and Regional Change, Cambridge, Mass., 1981. One survey is from Cunningham and Lopreato, *Energy Use and Conservation Incentives*; the other survey is from the St. Paul Energy Office, Energy Mobilization Survey, February 1980.

<sup>6</sup>Adaptations by low-income households to rising energy costs are summarized in, among other sources: Consumer Federation of America, "Low Income Consumer Energy Problems and the Federal Government's Response: A Discussion Paper," in *Residential Energy Conservation* (vol. II), OTA, Washington, D. C., 1979; Eunice S. Grier, and George Grier, *Too Cold... Too Dark* (Washington, D. C.: U.S. Community Services Administration, 1979).

Thus far, communities such as Hartford that are dependent on oil heat have borne a heavy share of the burden of rising energy costs. The variations between regions may be evening out, however. Controls on most natural gas prices are scheduled to be lifted by January 1, 1985, and households relying on natural gas may experience sharp price increases similar to those of households relying on oil heat.

Poor households already use less energy on average than higher income households, as is shown in table 49, so it is theoretically difficult for them to cut back further as energy costs increase. Evidence from survey data is mixed. Na-

(as well as all households) to higher energy bills from utilities is to not pay them. There is consid-

erable evidence of increasing bad debts reported by utility companies (see box H).

### Box H.-Bad Debts

**At least one response by consumers—and not just low-income customers—to rising energy costs is to let their accounts go into arrears. Data from utilities in three of the case studies shows that arrearages have increased substantially since 1978:**

- **National Fuel Gas Distribution Corp., which serves the Buffalo area, reports that residential accounts in arrears for the New York and Pennsylvania markets jumped from 65,737 in 1978 to 91,294 in 1981.**
- **City Public Service of San Antonio shows \$26.7 million worth of accounts receivable for 1979. For the year ending 1981, this had grown to \$32.3 million.**
- **The most dramatic rise was shown by Iowa power & light, which serves Des Moines. Here bad debt writeoffs grew from \$582,000 in 1978 to \$1.2 million in 1980. This was 0.3 percent of revenues in 1978 and 0.4 percent of revenues in 1980.**

**Ironically, shutoffs for these utilities did not show a dramatic rise. This is because most utilities are limited in their shutoff actions so as not to impose undue hardship on their low-income customers. Some utility officials feel that restrictions on shutoffs have contributed to the increase in bad debts. An Iowa Power & Light executive notes:**

**In 1978 the Iowa State Commerce Commission instituted new rules forbidding shutoffs on any day in which the temperature for that day or the day following was forecast to be below 20° F. However, with the passage of the new rules and attendant publicity, more and more people let bills lapse and bad debt writeoffs were accelerated. Knowing that disconnects were forbidden convinced larger numbers of customers to withhold payment during the colder months and then to simply terminate service and change addresses.**

**Note.—The material in this box is drawn from unpublished data supplied by Iowa Power & Light (Des Moines, Iowa), City Public Service Board (San Antonio, Tex.) and National Fuel Gas Distribution Corp. (Buffalo, N.Y.)**

## ENERGY EFFICIENCY OF LOW-INCOME HOUSING

The housing stock occupied by lower income households is not universally less energy efficient than the housing stock occupied by households with moderate or upper incomes. Rather, the energy efficiency of the housing of low-income households differs from the housing of other income groups in a few important respects that are significant for the formation of public policy.

The best data are available on the energy efficiency of single-family houses. Using data from the 1977 annual housing survey, the Urban Institute classified the single-family housing stock into those with three specific energy-saving features present—attic insulation, storm windows, and storm doors—and those with one or more of these energy saving features absent.<sup>7</sup> Table 50

shows how the characteristics of single-family houses occupied by low-income people (defined as those with less than \$8,000 annual income) compare to the general characteristics of single-family houses. More than 4 million of these low-income households own houses that have all three energy-saving features present. Another 4 million own houses that have only one or two energy features missing. For these two categories the housing stock of the poor is not dramatically less energy efficient than the housing occupied by other income groups.

In two other respects, however, the housing stock of the poor is less energy efficient than the housing stock in general. Poor households occupy about half of the more than 3 million owner-occupied houses with all three energy-saving features absent. Poor households who rent their houses occupy about two-thirds of all rental houses with all three energy-saving features

<sup>7</sup>Michael Andreassi, Lorene Yap, and Olson Lee, *The Impact of Residential Energy Consumption on Households* (Washington, D.C.: The Urban Institute, June 1980), HUD contract No. H-2882.

**Table 50.—Energy Efficiency Characteristics of Single-Family Houses Occupied by Low-Income People Compared to All Single-Family Houses**

|   | All households (millions) | Households with less than \$8,000 annual income in 1977 (millions) | Low-income households as a percent of all households (percent) |
|---|---------------------------|--|--|
| <i>Owner-occupied single-family houses</i>                |                           |  |  |
| <b>All three energy saving features present . . . . .</b> | <b>23.0</b>               | <b>4.3</b>   | <b>19%</b>   |
| <b>One or two features missing . . . . .</b>              | <b>16.0</b>               | <b>4.2</b>   | <b>28</b>  |
| <b>All three features missing . . . . .</b>               | <b>3.2</b>                | <b>1.6</b>   | <b>49</b>  |
| <i>Renter-occupied single-family houses</i>               |                           |  |  |
| All three energy saving features present . . . . .        | 1.9                       | .6   | 33   |
| One or two features missing . . . . .                     | 4.7                       | 2.4  | 51   |
| All three features missing . . . . .                      | 1.8                       | 1.2  | 64   |
| Total households. . . . .                                 | 50.6                      | 14.3   |  |

SOURCE: 1976 *Annual Housing Survey*, as analyzed by the Urban Institute in Andreassi, Yap, and Lee, op. cit.; and the Office of Technology Assessment.

missing and about half of all rental houses with one or two features missing. The large fraction of renters among low-income occupants of energy-inefficient single-family houses creates special problems for public policy, which will be discussed below.

In all, about 2.8 million of the 5 million single-family houses lacking all three energy-saving features, are occupied by poor households. These 5 million houses pose a special challenge to prospects for retrofit because almost half of them (45 percent) were built before 1940 and more than half of them (53 percent) are structurally inadequate, as well as energy inefficient. That means that they have one or more of the defects, listed in table 51, such as no kitchen or a shared kitchen, or at least two maintenance problems such as a leaking roof, open cracks or holes in interior walls or ceiling, or exposed wiring. Some of these defects, especially leaking roofs or holes in walls or floor, would have to be fixed before the house could be made energy efficient. (Some defects such as no heating system, on the other hand, mean that the house doesn't waste heating energy because it doesn't use any.) Other defects, such as the absence of plumbing, are not directly linked to the prospects of retrofitting a house but they enter into

<sup>8</sup>Andreassi, et al., op. cit.

**Table 51.—Structural Adequacy<sup>a</sup> of Occupied Single-Family Houses by Presence of Energy-Saving Features, 1976 (percentage distribution)**

|                                   | Units containing all three features | Units lacking one or more features |                            |
|-----------------------------------|-------------------------------------|------------------------------------|----------------------------|
|                                   |                                     | Total                              | Lacking all three features |
| Structurally adequate . . . . .   | 96.9%                               | 79.8%                              | 47.770                     |
| Structurally inadequate . . . . . | 3.1                                 | 20.2                               | 52.6                       |
| Total. . . . .                    | 100.0                               | 100.0 <sup>b</sup>                 | 100.0 <sup>c</sup>         |

<sup>a</sup>A unit is defined as inadequate if it has one or more of the following defects: unit lacks or shares complete plumbing facilities; lacks or shares a complete kitchen; lacks a septic tank, cesspool, or hookup to a public sewer system; does not have any means of heating or heating is from unvented room heaters burning gas, oil, kerosene, or from fireplaces, stoves, or portable room heaters; suffers from any two maintenance problems consisting of a leaking roof, open cracks or plaster or peeling paint on interior walls or ceiling; or has exposed wiring and lacks a working wall outlet in one or more rooms. This definition is a modification of the definition used in the HUD series, "How Well Are We Housed?"

<sup>b</sup>The distribution in this column is significantly different (at the 5-percent level or better) from the distribution in the first column.

SOURCE: 1976 *Annual Housing Survey*, data analyzed in Andreassi, et al. (see footnote ?).

the calculations of the owner, tenant, or public agency about the value of making any investment in the house, even an investment to save energy expenses.

Given an older building and one with other deficiencies, it is also likely that there are other energy wasteful features of such buildings such as lack of wall insulation or very inefficient heat-



ing systems. For such buildings it should be technically possible to reduce energy use by a large fraction (at least 50 percent) through retrofits of low and moderate capital cost (as described in ch. 3).

There is some evidence that energy-inefficient single-family houses are somewhat more concentrated in central cities than in suburbs. According to a 1976 Housing and Urban Development (HUD) study, single-family houses in the central city are more likely to lack storm windows and doors (about two-thirds) than are single-family houses in the suburbs (about half), and are more likely to lack insulation (20 percent) than houses in the suburbs (12 percent).<sup>9</sup>

Unfortunately very little data is available on the energy efficiency and condition of multifamily buildings occupied by low-income households. Overall, multifamily buildings with two to four units are less likely to lack one or more energy saving features (32 percent) than are single-family houses (51 percent). There is no data at all on energy saving features in multifamily buildings of five or more units.<sup>10</sup>

The poor structural condition of the low-income housing stock has important ramifications for the prospects of retrofit. Most low-income units will require basic structural repairs before conservation measures can be effective. Many city rehabilitation programs do address energy conservation indirectly. If a roof must be replaced, for example, insulation is usually added. But public rehabilitation programs, by far the largest resource for dealing with substandard units in cities place correction of code violations above energy conservation. In some cities, energy conservation is well down a list of priorities, below both code correction and exterior improvements. Local weatherization officials are conscious that their work treats only part of the overall structural condition of the unit, but they are constrained by limitations on what can be spent per unit under the weatheri-

<sup>9</sup>David R. Karol, "Shelter and Neighborhoods: Indicators of Physical Deterioration in Cities," pp. 136-138, in *Occasional Papers in Housing and Community Affairs*, vol. 4, Department of Housing and Urban Development, July 1979.

<sup>10</sup>Andreassi, et al., op. cit., pp. 16-17.



Photo credit: Office of Technology Assessment

Housing that is both energy inefficient and structurally inadequate is a big problem in San Antonio and other U.S. cities

zation program. A Texas weatherization official notes that in his State there is a \$100 limitation on repairs, beyond basic weatherization activities. "For \$100 you can patch but not replace a roof and that could be a problem in a place like San Antonio."<sup>11</sup>

OTA has found no documentation of the extent of repairs required beyond weatherization in most urban units. However, interviews with housing and weatherization officials in the case study cities, as well as with those involved in these programs nationally, indicates that extensive structural repairs in low-income housing is an important factor in the rate of retrofit of such units. In San Antonio, for example, the city estimates that 27 percent of its housing is substandard (the largest fraction in any case study city). Of the total of about 69,000 substandard units, more than 17,000 (or 39 percent) are not suitable for rehabilitation. A local human services official observes: "In San Antonio, the only homes that could really be weatherized under the program are middle-class homes."<sup>13</sup>

<sup>11</sup> See San Antonio case study.

<sup>12</sup> City of San Antonio, Community Development Block Grant, Three Year Plan, as amended, February 1980.

<sup>13</sup> See San Antonio case study.

## PROSPECTS FOR ENERGY RETROFIT OF LOW-INCOME HOUSING—PRIVATE EFFORTS

The prospects for the retrofit of low-income housing are limited but they are much better for owner-occupied housing than for renter-occupied housing. The discussion of energy investment in rental housing in this section is a brief summary of a much longer section in chapter 4 (Will Building Owners Retrofit Their Buildings?).

**Owner-Occupied Low-Income Housing.** Before discussing the prospects for the retrofit of owner-occupied low-income housing it is useful to remember that almost one half (45 percent) of low-income homeowners are elderly.<sup>14</sup> Not surprisingly, people over 65 also own a large fraction (37 percent) of the owner-occupied single-family houses with three or more energy-saving features missing.<sup>15</sup> It is also useful to remember that about 2 million small multifamily buildings of less than five apartments (or duplexes) are owner occupied,<sup>16</sup> These buildings are treated like owner-occupied single-family buildings in such public programs as weatherization and many housing rehabilitation programs funded with community development block grants (CDBG). The prospects for retrofit of these buildings are similar to those of the single family owner occupied. There is no data on how many of these are occupied by low-income people.

Survey data on the willingness of low-income households to invest in energy retrofit show that such households are as willing or almost as willing as higher income households to invest in less expensive retrofits such as inexpensive insulation, caulking, or weatherstripping but are much less willing to invest in more expensive insulation. Data from the 1975 survey of communities in the Southwest showed that low-income families required that investments in insulation pay for themselves in less than 2 years while

higher income families would consider investments that paid for themselves in 3 or 4 years.<sup>17</sup>

According to a national survey of energy conservation (NIECS), households with incomes less than **\$5,000** per year were almost as likely as higher income households to purchase inexpensive insulation (17 percent of the lower income households in contrast to **25** percent or more of the higher income households) but were much less likely to buy expensive insulation or any form of equipment to improve efficiency. Less than 1 percent of households with less than **\$5,000** annual income made the latter kinds of energy conservation investments compared to **6 to 8 percent** or more of higher income households.<sup>18</sup>

Low-income households appear to respond to the availability of free utility audits in much lower numbers than do higher income households. The Tennessee Valley Authority (TVA) visited 270,000 homes, in probably the largest single audit program in the country. In the TVA service area, more than 20 percent of the families have incomes below \$5,000 and 15 percent of all the homes in the service area lack insulation. Yet in a recent survey made by TVA to evaluate the audit program, the analysts found that only 5.2 percent of homeowners below \$5,000 had **been** audited and only 2.6 percent of renters. This was in comparison to 18.7 percent of families earning above \$25,000 who took advantage of the audit.<sup>19</sup>

Few low-income families (quite predictably since they have low tax liability in the first place), take advantage of the residential energy tax credit (described in ch. 9). Of the **40** million households with taxable incomes of less than \$10,000 per year, only 1.2 percent took the resi-

<sup>14</sup>School of Engineering and Applied Sciences, George Washington University, *Energy Implications of an Aging Population*, prepared for USDOE, contract No. ACOI-79ER10041, August 1980, pp. 36-49.

<sup>15</sup>Andreassi, et al., op. cit., P. 26.

<sup>16</sup>U.S. Census, *General Housing Characteristics*, United States and Regions 1977 and 1978.

<sup>17</sup>Frieden, Op. cit., p. 27, referring to the Lopreato and Cunningham survey cited above.

<sup>18</sup>Frieden, op. cit., p. 25.

<sup>19</sup>Robert F. Hemphill, and Ronald L. Owens, "Burden Allocation and Electric Utility Rate Structures: Issues and Options in the TVA Region," Tennessee Valley Authority, Oct. 9, 1980.

dential energy tax credit in 1978, compared to 16.5 percent of the 22 million households with taxable incomes of more than \$20,000 per year. Low-income households often don't have sufficient tax liability to use the tax credit in a single year; a quarter of those taking the credit carried the amount forward into subsequent tax years.<sup>20</sup>

In summary, there is some evidence that low-income homeowners will partially retrofit their houses in response to rising energy costs but there is further evidence that they are unlikely to do any extensive retrofit without outside assistance.

**Renter-Occupied Low-Income Housing.** Although tenants may occasionally perform low-cost retrofits such as caulking and weatherstripping, the prospects for any extensive retrofit of low-income rental housing depend on decisions of landlords to retrofit their buildings. The influences on building owners' decisions to retrofit are described at length in ch. 4, "Will Building Owners Invest in City Buildings?" This section summarizes the prospects for retrofit by owners of low-income buildings, and some of the impacts on low-income tenants.

Low-income rental buildings vary, from the small building with two or three apartments owned by a low-income retired couple to the high-rise with 40 to 50 apartments owned by a real estate partnership. For all this variation, the most important influence on the prospects for retrofit of such buildings is whether the tenants or the owner pay for fuel and electricity.

**Master-Metered Buildings: Where the Owner Pays for Utilities.** There is no doubt that rising energy costs are a burden to owners of master-metered buildings. While financing and tax costs on these buildings are low, the rents are relatively lower and there is little margin to raise rents to accommodate increases in operating costs due to higher fuel and electricity bills. On the other hand, there are few incentives for the owner of a master-metered building occupied primarily by low-income families to engage in retrofit. Many of these buildings are located in marginal neighborhoods and the future resale

value of these properties, even if they were more energy efficient, is limited. Only if buildings are located in potentially revitalizing areas are the owners likely to even consider investing in retrofit. At this point owners must reckon with the lack of access to financing for building improvements especially for low-rent buildings in locations that banks regard as uncertain. Without access to relatively long-term financing at less than exorbitant interest rates, it is impossible to pay for a retrofit out of the buildings' cash flow (by offsetting financing costs by reductions in energy costs).

OTA's analysis in chapter 4 of a hypothetical low-rent building drawn from St. Louis data illustrates the dilemma for a building owner very clearly. With longer term (10 year) financing and moderate (13 percent per year) interest rates the building owner would be able to substantially improve the building's cash flow with a retrofit. With a loan of shorter term (5 years) and high interest rate (16 percent per year) there is a sharp reduction in the building's cash flow for at least 5 years. Since loan terms and interest rates available to owners of low-income buildings tend to be respectively much shorter and higher than those analyzed for this hypothetical building it is clear that building owners can only retrofit if they are willing to accept a sharp reduction in cash flow.

Rather than invest in retrofit, owners of master-metered buildings are likely to cut back on services or maintenance or go into arrears on their fuel bills. In Jersey City, for example, heating complaints rose from 2,400 in 1980 to almost 3,400 for 1981, an increase that is almost entirely attributable, according to the city's chief building inspector, to a cutback in heating service by multifamily building owners. Typically, he says, "landlords turn the heat off from 1 to 4 in the afternoon when they think no one is home, as a way to conserve."<sup>21</sup> In New York City, with its enormous housing stock, heating complaints increased from 225,000 in 1978-79 to 320,000 in 1980-81.<sup>22</sup>

<sup>21</sup> Interview with chief building inspector, Jersey City, N. J. See Jersey City case study.

<sup>22</sup> Telephone interview with Joseph M. White, Director of Operations, Division of Code Enforcement, New York City Department of Preservation and Development.

<sup>20</sup> Internal Revenue Service Preliminary Report Statistics of Income— 1979 Individual Tax Returns, Washington, D. C., 1980.

Officials in several cities attribute the rise in abandonment in part to the multifamily owner's inability to cope with rising energy costs. A Jersey City housing official notes: "Taxes and energy are the keys to abandonment in this city. What happens is that increased taxes and rising energy costs come at the same time that these older buildings are due for major repairs. But landlords cannot jack the rents up because people are too poor. The smaller landlords are usually well in over their heads already and they do not know how to cope. They sell to the large absentee owners who cut services and the good tenants move out."

There is, in fact, no consensus among observers of real estate on the linkage between energy and abandonment. The best guess is that rapidly rising energy costs are the "last straw" for buildings unable to continue covering their expenses with adequate rents. Two analyses of abandonment in Rochester, N. Y., serve to illustrate the controversy. One analysis, by the former director of Rochester's neighborhood rehabilitation program relates a striking increase in abandoned buildings from 1970 to 1978 to the rapid increases in the costs of oil, gas and electricity over the same period.<sup>23</sup> (See table 52). A somewhat earlier analysis of Rochester's abandonment problem by a real estate analysis



Photo credit: Office of Technology Assessment

Housing oversupply is often the general cause and rapidly increasing energy prices the immediate cause of housing abandonment in cities like Buffalo

<sup>23</sup>Eugene Kramer and Linda Berger, "The High Cost Of Heat: A New Threat to City Neighborhoods," papers for the Energy in the Cities symposium, American Planning Association Report No. 349.

**Table 52.—Comparison of Increases in Abandoned Buildings With Increases in Energy Costs in Rochester, N.Y.**

| Y e a r | Vacant buildings | Average annual home heating costs (in dollars) |       |          |
|---------|------------------|--|-------|----------|
|         |                  | Oil  | Gas   | Electric |
| 1970    | 300-400          | \$199  | \$184 | \$310    |
| 1974    | 370              | 321  | 224   | 415      |
| 1975    | 821              | 332  | 229   | 404      |
| 1976    | 1,125            | 406  | 290   | 533      |
| 1977    | 1,500            | 416  | 308   | 511      |
| 1978    | 1,900            | \$503  | \$369 | \$646    |

SOURCE: E. Kramer and L. Berger, "The High Cost of Heat: A New Threat to City Neighborhoods," papers for the Energy in the Cities, Symposium, American Planning Association, report No. 349.

firm had, however, uncovered a much deeper reason for significant abandonment of older housing stock in the Rochester area—Rochester suffered from an excess supply of new housing in the early 1970's. Although there was an increase in population of only about 8,300 persons between 1970 and 1975 in the Rochester metropolitan area, a total of almost 40,000 new units of housing were built, enough to accommodate (after allowing for replacement of lost housing inventory) a population increase of 88,500 or about 10 times what actually occurred. This new housing encouraged a series of "trading up" moves into better housing and resulted in an excess supply of the oldest housing stock in the central city, which in turn

became candidates for abandonment.<sup>24</sup> Rapid increases in energy costs are likely to have made it difficult for owners of this excess housing to hang on to their buildings until the era of housing oversupply came to an end. In this sense, energy costs can be accused of being the trigger for the actual abandonment.

**Tenant-Metered Buildings: Where Tenants Pay for Utilities.** Once a building is tenant metered, there are no further incentives for an owner to invest in energy retrofit. Under current market conditions there is no evidence that owners charge higher rents for an energy efficient building, all other things being equal. (Ch. 4 has an extensive discussion of tenant metering.) There is evidence that conversion from master to tenant metering does lead to behavioral efforts by tenants to conserve energy. These are much more pronounced for electricity than for fuel.<sup>25</sup>

There is no data on the extent of conversions from master to tenant metering in low-income buildings. For multifamily buildings in general, conversion to tenant metering is believed to be common although there is also no data.

For all the potential benefits of inducing energy conserving behavior, however, conversion to tenant metering will, under the most common utility pricing practices, cause financial hardship for low-income tenants.<sup>26</sup> A

<sup>24</sup>M. Leanne Lachman and Maxine V. Mitchell, "New Construction and Abandonment: Musical Chairs in the Housing Stock," *Nation's Cities*, September 1977.

<sup>25</sup>Lou McLelland, *op. cit.*, in footnote 4 to ch. 4.

<sup>26</sup>There are three basic metering types for multifamily rental housing:

- a master meter, which serves the entire building or a series of units in the building. The owner is the customer of the utility and rental payments include utilities. There is no recordation of individual unit or common area usage. This may be combined with allocations of energy costs. Bills are based on commercial rate structure.
- a submeter system, which combines a master utility meter with a separate set of privately owned and installed meters for each apartment. The buildings owner is still the customer of the utility, at commercial rates, but can bill tenants separately for individual consumption.
- individual meters, which use a separate utility meter for each unit. The tenant is the direct consumer of the utility, and is billed at individual rates. Rent only includes utility services for common areas of the building.

master-metered (and submetered) building is generally served under a commercial rate structure, which results in a lower per unit cost than a residential rate. Individually metered apartments, however, are subject to the higher individual rate schedules. Commercial users often can elect interruptible service and time-of-day rate schedules, which further reduce rates. And the majority of States still maintain declining block or promotional rate structures, which make energy less expensive per unit consumed the larger the quantity consumed through a single meter per billing period. While this may provide a disincentive to conserve, it does provide a significant cost advantage for master-metered over tenant-metered units.<sup>27</sup>

There is only anecdotal evidence on the extent of higher cost for tenant-metered utilities. Calculations on multifamily meter conversions for Detroit, Atlantic City, and St. Paul for example, show that the same amount of power will cost 33 percent more in individually metered apartments than in a master-metered building. The manager of a Philadelphia apartment house that may convert to tenant metering found that the total price of gas for apartments would double for the same quantity after the conversion.<sup>28</sup>

There are other costs as well. Tenants that are converted to individual meters are normally required to post a security deposit with utility suppliers. This can be \$75 to \$100 or the equivalent of 2 months usage, and can pose a substantial financial obligation, particularly for low-income tenants without a prior credit history. Individually metered tenants are more likely to pay penalties for late payments.<sup>29</sup>

<sup>27</sup>Steven Ferrey & Associates, "Fostering Equity in Urban Conservation: Utility Metering and Utility Financing," see working papers, pp. 24-25.

<sup>28</sup>Ferrey, *op. cit.*, p. 25.

<sup>29</sup>*Ibid.*, p. 26.

## PROSPECTS FOR RETROFIT: PUBLIC HOUSING

Public housing provides about one-fifth of the low-income rental housing in this country. There are at present about 1.2 million units of public housing in about 9,900 projects around the country; these house more than 3.4 million tenants, a sizable portion of whom are elderly or handicapped. so Over 60 percent of these units are located in large- and medium-sized cities. Public housing represents a major capital investment for the Nation; about \$20 billion has been spent to develop these projects since the program began in 1937.

Energy cost has been the most rapidly escalating operating cost for public housing managers and tenants. Like much of the private housing stock described in this chapter, public housing was built when energy was cheap and energy consciousness was low. Today, housing authorities and tenants are saddled with high energy costs—the average in 1980 dollars is \$670 per dwelling unit. (See box 1 for a discussion of energy payments by public housing tenants.) Energy costs overall for housing authorities rose 400 percent between 1970 and 1980.<sup>31</sup> These cost increases have been an important factor in the growth of the Federal operating subsidy requirements to housing authorities in recent years. Operating costs virtually tripled between 1968-78, while monthly rents have increased less than 50 percent.<sup>32</sup>

The poor thermal quality of public housing is a matter of great concern to administrators of the program. Most of the stock was built before rigorous energy standards were instituted by HUD. There is, however, considerable potential for energy savings in the public housing stock (table 53). A recent HUD study estimates that an average investment of about \$1,100 per unit (1980 dollars) will yield an average annual



Photo credit: Office of Technology Assessment

HUD modernization funds have been used to improve the energy efficiency of public housing projects (such as this one in Tampa, Fla.) as well as to make them safer and more marketable

### Box 1.—Rising Costs: Public Housing

Public housing tenants, like low-income tenants in other rental units, do not have different energy needs, but they do have different unit characteristics. Public housing units are generally older and less energy efficient.

By law, public housing tenants pay no more than 30 percent of their gross income for their rent. The United States A utility department has a goal of HUD to attempt to pay utility bills for these tenants.

Master meters are used in public housing to receive no utility bills and to pay directly for utility consumption. Because they are associated with high energy costs, public housing units are often not portable. In fact, the HUD study estimates that the cost of utility bills for public housing tenants is about 30 percent of the cost of gas, electricity, and water for a fully comparable unit. The study also estimates that the cost of utility bills for public housing tenants is about 30 percent of the cost of gas, electricity, and water for a fully comparable unit. The study also estimates that the cost of utility bills for public housing tenants is about 30 percent of the cost of gas, electricity, and water for a fully comparable unit.

<sup>30</sup>National Association of Housing and Redevelopment Officials, "Profile of the Public Housing Program," memo to Large Housing Authority Working Group, Washington, D. C., Feb. 12, 1981.

<sup>31</sup>Ibid.; Perkins & Will, the Ehrenkrantz Group, "An Evaluation of the Physical Condition of the Public Housing Stock" (executive summary-draft), HUD, Office of Policy Development and Research, March 1980.

<sup>32</sup>National Association of Housing and Redevelopment Officials, op. cit.

data of PHA consumption.<sup>1</sup> Individually metered tenants receive a utility allowance based on the historic average consumption of similarly sized units for similar construction. The allowance is a cash deduction from monthly rent and tenants can basically do with the money what they please.

This system appears to penalize the individually metered tenant. Tenant-metered units receive an allowance for utilities that can be 35 to 50 percent less than that received by identically situated submetered tenants,<sup>2</sup> even though the per unit cost of energy may be higher in States with declining block or commercial multifamily rates. Furthermore, individually metered tenants are subject to security deposits, late payment fees, and other charges, similar to their counterparts in the private market. Perhaps most serious “the simplistic allowance formula makes no provision for units which because of their location within a building or because of poor thermal quality, are inherent energy wasters beyond tenant control.”<sup>3</sup>

<sup>1</sup>Ferrey, *op. cit.*, pp. 40-41.

<sup>2</sup>*Ibid.*, p. 42.

<sup>3</sup>*Ibid.*, p. 42.

savings of about \$300, and would reduce average energy consumption from the current 145 million Btu per unit to about 80 million Btu.<sup>33</sup>

<sup>33</sup> Perkins & Will, *op. cit.*

### Box J.-Energy Consciousness in Public Housing: Case Study Cities

The seriousness with which housing authorities are taking energy conservation was clearly observed in several of the case study cities. Among the retrofit activities were the following:

- The Buffalo Housing Authority has spent several million dollars to insulate, retrofit windows, install energy controls, replace entrance doors, and upgrade heating plants in three large projects. The author-

**Table 53.—Energy Conservation Potential of Public Housing**

| Energy conservation category                | Potential cost savings |
|---|------------------------|
| Operation and maintenance . . . . .         | 11 %/0                 |
| Windows and door improvements . . . . .     | 13                     |
| Wall/ceiling/roof insulation. . . . .       | 6                      |
| Mechanical equipment improvements . . . . . | 13                     |
| Electrical. . . . .                         | 2                      |
| Other . . . . .                             | 4                      |
| National Average . . . . .                  | 480/0                  |

NOTE: The above averages were based on an analysis of 58 energy conservation opportunities in a randomly selected representative sample of public housing projects

SOURCE: Energy Conservation Handbook, vol 3 (draft), U S Department of Housing and Urban Development Apr 15, 1981, prepared by Perkins and Will II, The Ehrenkrantz Group

HUD has already begun to act on a program of retrofitting public housing projects, within the agency's constrained budget. In September 1980, HUD awarded \$23 million to 47 public housing authorities for modernization of oil heating systems. These funds are being used to upgrade existing oil heat systems and to convert to dual-fuel systems. HUD has also awarded \$5 million to 61 public housing authorities to install and test new energy-conserving devices. OTA found that in the case study cities, HUD modernization money is being used by housing authorities in part for energy conservation measures, such as replacing windows, installing storm doors, and insulation .34 (See box J.)

<sup>34</sup> Department of Housing and Urban Development, “HUD finds PHA test to cut energy costs,” HUD release of Sept. 23, 1980; HUD awards paid energy efficiency” (HUD release of Sept. 29, 1980); also see case studies.

ity recently received \$200,000 under HUD's conservation demonstration program which it will use to install a trifuel heating system in a 900-unit project.

- The Jersey City Housing Authority has received \$4.6 million in energy conservation grants from HUD. The majority of this money will be used to replace windows in existing projects and to replace steam lines with new insulated piping. The authority has also upgraded and improved the efficiency of oil burners in its projects.

- The San Antonio Housing Authority has received \$260,000 under HUD's Solar Demonstration Program to test various solar applications on a 27-building complex. The housing authority had already installed a solar domestic hot water system on a 65-unit project for the elderly in 1978 and retrofitted hot water heaters to solar on several other projects.
- The Tampa Housing Authority was the first in the Nation to install solar hot water heating—some 30 years ago. The authority

is upgrading these solar units and experimenting with more advanced panels under a \$30,000 grant from HUD. The authority is also retrofitting several projects by installing storm windows and doors and some insulation, and upgrading gas burners. A new project has been built with a central heating system that can convert easily to solar. The authority is also considering the use of heat pumps for some projects.

## FEDERAL PROGRAMS THAT ADDRESS THE ENERGY NEEDS OF LOW-INCOME HOUSEHOLDS

The Federal Government has tried to help low-income households cope with rising energy prices through two approaches: One provides direct cash assistance for payment of utility bills on an emergency or short-term basis. The other takes a longer term approach and provides resources for making the structure more energy efficient. The first approach is exemplified by the Low-Income Energy Assistance program; the second by the Weatherization program.

### Direct Cash Assistance

Since 1977, the Federal Government has sponsored a series of cash assistance programs designed to help low-income families deal with rising energy prices (see table 54). Federal funding has grown from \$200 million in 1977 to \$1.85 billion appropriated in 1981. In 1981, it is estimated that about 10 million households will be aided by the direct cash assistance approach, the highest activity level thus far.

The basic purpose of all of these programs has been to help low-income families supplement their income so they can pay their utility bills. In some cases, this is done on an emergency or one-shot basis, in others as a supplement for a defined period (usually a year). Beyond this, however, the programs have differed substan-

tially in terms of benefits, allocations, eligibility, and other factors.<sup>35</sup>

Until 1980, these programs served households whose income fell below 125 percent of the Office of Management and Budget (OMB) poverty guideline—about 8.5 million households.<sup>36</sup> In 1980, the eligibility ceiling was expanded to cover all those households whose income fell below the Bureau of Labor Statistics lower living standard, which added an additional 6.5 million eligible families.<sup>37</sup> States may apply more restrictive income eligibility standards under the current programs, but they must give priority to the most needy families, regardless of their source of income. States must also provide special outreach activities for the elderly and disabled. Preliminary State plans analyzed by CBO indicate that about 10 million households, out of a potential 17.2 million, will be served under the 1981 program. Benefits will average \$160 per household, or 19 percent of the average home energy expenditure of eligible families.<sup>38</sup>

<sup>35</sup>Congressional Budget Office, *op. cit.*, pp. 45-55; contains an excellent summary of the program.

<sup>36</sup>*Ibid.*, p. 27.

<sup>37</sup>*Ibid.*, p. 27.

<sup>38</sup>*Ibid.*, p. 20.



**Table 54.—Summary of Low-Income Energy Assistance Programs, Fiscal Years 1977-81**

| Year         | Program                              | Funds appropriated (billions of dollars) | Households served (millions) | Average benefit per household (dollars) |
|--------------|--------------------------------------|--|------------------------------|---|
| 1977 . . . . | Special Crisis Intervention Program  | \$0.20                                   | 1.2                          | \$140 <sup>a</sup>                      |
| 1978 . . . . | Emergency Energy Assistance Program  | 0.20                                     | 0.9                          | 165                                     |
| 1979 . . . . | Crisis Intervention Program          | 0.20                                     | b                            | b                                       |
| 1980 . . . . | Energy Crisis Assistance Program     | 0.40                                     | 1.6 <sup>c</sup>             | 188 <sup>d</sup>                        |
|              | Energy Allowance Program             | 0.80                                     | 4.4 <sup>c</sup>             | 150 <sup>d</sup>                        |
|              | SSI-Energy Allowance Program         | 0.40                                     | 4.0 <sup>c</sup>             | 97 <sup>d</sup>                         |
| 1981 . . . . | Low-Income Energy Assistance Program | 1.76                                     | 10.0 <sup>e</sup>            | 161 <sup>f</sup>                        |
|              | Crisis Intervention Program          | \$0.09                                   | b                            | b                                       |

<sup>a</sup>CBO estimate, assuming the percent of funds spent on administration was the same as in 1978

<sup>b</sup>Data not available.

<sup>c</sup>These figures represent preliminary estimates of the number of payments made to households rather than the number of households served. Some households received more than one benefit.

<sup>d</sup>Since some households received more than one benefit, the average benefit per household is actually somewhat higher than the average listed here. Estimates are preliminary.

<sup>e</sup>State estimates, as of January 1981

<sup>f</sup>CBO estimate, assuming all available funds are spent, and States spend the maximum of 7.5 percent of funds on administration

SOURCE: Congressional Budget Office estimates, based on published and unpublished documents

under the 1981 program, States can provide energy assistance either through direct cash payments, vendor payments, or vouchers for the household to use for energy supplies. They can also use up to 3 percent of their allocation for in-kind assistance, such as warm clothing or minor home repairs. Until 1981, cash assistance programs were designed primarily to deal with winter-related energy costs and thus were targeted primarily to home heating. As of 1981, however, States can also set aside funds for health-related cooling expenses, although only 12 have chosen to do so.<sup>39</sup>

About 60 percent or 9.9 million of the families eligible for cash assistance participated in the program in 1980. **Under the more lenient eligibility formula** for 1981 which includes most renters, for example, slightly more families are expected to participate. However, this will be only about 50 percent of the eligible households, if the estimates in State plans hold up.<sup>40</sup>

There is some uncertainty about what impact current cash assistance approaches have on

<sup>39</sup>ibid., p. 31.

<sup>40</sup>ibid., pp. 49 and 53.

the incentives to retrofit. Under the 1981 program, States allocate benefits according to general characteristics of a household's energy burden, as determined by type of fuel, income, household size, and intrastate region. The CBO report observes:<sup>41</sup>

Since this approach ties benefits to factors that relate to a household's home energy burden—such as intrastate region—but not to a household's actual home energy expenditures, it likely leads to fairly small conservation disincentives in the short run. In the long run, however, it might cause households to make decisions concerning location and heating fuel that are economically inefficient.

While critics acknowledge that crisis assistance may always be needed, especially in severe winters when the energy needs of the poor may outstrip their ability to pay, such programs could increase ad infinitum unless coupled with preventive programs that address the root causes of the energy problems of the poor, especially the basic structural condition of their homes.

<sup>41</sup>ibid., p. 33.

## Weatherization

The concept underlying weatherization programs is to reduce energy consumption by low-income households by making their dwelling more energy efficient. The program was administered by the Community Services Administration between 1975 and 1978, with weatherization assistance also offered by DOE in 1977 and 1978. **Since 1979, all weatherization activities have been administered** by DOE with funding at an approximate level of \$200 million a year for 1979-81.<sup>42</sup>

Under the current program, DOE allocates funds to States, which in turn mete out money to local community action agencies. Households with income less than 125 percent of the OMB poverty level are eligible for the program, as are families with at least one AFDC (Aid to Families with Dependent Children) or SSI recipient. This comes to about 17.6 million households.<sup>43</sup>

Weatherization activities typically include caulking, weatherstripping, installing storm windows, insulating attics, and in some cases, walls. The average expenditure per household in 1980 was \$600, but this is expected to rise to \$1,000 per household in 1981, the maximum allowed under the program in most areas.<sup>44</sup>

The weatherization program has been fraught with administrative, financial and managerial problems. Requirements that CETA (Concentrated Employment and Training Act) labor must be used, recently waived, hampered the program in many areas. So did the lack of effective audit procedures to determine which homes would most benefit from the program, resources for training and supervising weatherization crews, and monitoring completed weatherization work.<sup>45</sup>

<sup>42</sup> Congressional Budget office, Op. Cit., p. 5.5.

<sup>43</sup> Ibid., p. 28.

<sup>44</sup> Ibid., p. 55.

<sup>45</sup> See General Accounting office, *Slow Progress and Uncertain Energy Savings in Programs to Weatherize Low-income Households*, Report to Congress EMD80-59, May 1980; also Christian Demeter *The Weatherization Assistance Program. A Status Report*, Urban Systems Research and Engineering, Inc., for DOE, Washington, D. C., July 1980; also case studies.

Activity levels under the program have been quite low in proportion to need, although activity has been greatly stepped up in recent years. Between 1975 and 1979, less than 250,000 homes had been weatherized and only 21 percent of the \$480.5 million in available funds had been used. By September, homes were being weatherized at about 30,000 a month, a virtual doubling of previous activity. By the end of 1981, DOE officials estimate that approximately 820,000 homes will have been weatherized. If this projection holds, about 6 percent of eligible households will have been reached by the program.<sup>46</sup>

The impacts of weatherization on reduced energy consumption vary, depending on climate and structure, but several recent studies indicate that this is a reasonably cost-effective program.<sup>47</sup> Still, weatherization is extremely limited as a retrofit tool for the most needy urban households. The reasons for this have been touched on elsewhere in this chapter. For one thing, many of the homes of the urban poor have serious structural problems which must be addressed before weatherization will really contribute to making the structure more energy efficient. In most cases, weatherization activities and rehabilitation program are not coordinated at all.<sup>48</sup> The basic repairs needed before weatherization can truly be effective are not eligible expenses under weatherization programs.

In addition, there are serious limitations on the application of weatherization funds to rental properties in which more than half of the urban poor live.

In cases where weatherization covers rental properties, landlords must sign a rental agreement not to raise rents for a stated period of time—a restriction few landlords are willing to accept. High tenant turnover in low-income multifamily properties makes these agreements difficult to enforce. In many cases, such properties are owned by absentee landlords who are difficult to locate and who have diminished in-

<sup>46</sup> Congressional Budget Office, pp. 55-56.

<sup>47</sup> Ibid., pp. 40-41.

<sup>48</sup> Rehabilitation programs are discussed in greater detail in ch. 10. The case studies also provide ample documentation of this point.

## **Chapter 8**

# **Prospects for District Heating**

## Chapter 6

# Prospects for District Heating

## Contents

|   | <i>Page</i> |  | <i>Page</i> |
|---|-------------|--|-------------|
| Introduction . . . . .  | 165         | Conditions for a Successful District Heating System. . . . . | 191         |
| Context for U.S. District Heating in the 1980's. . . . .  | 166         | Options for Federal Policy Toward District Heating. . . . .  | 193         |
| Conditions for Viability of a District Heating System in the United States. . . . .             | 172         |  |             |
| Capital Costs of District Heating. . . . .  | 173         |  |             |
| Variations in District Heating Systems. . . . .   | 182         |  |             |
| Noncapital Costs of District Heating. . . . .   | 185         |  |             |
| Competitive Pricing of District Heating Systems and the Building Owner's Point of View. . . . . | 186         |  |             |
| Contingencies in Planning a District Heating System. . . . .                                    | 188         |  |             |

LIST OF TABLES

| <i>Table No.</i>  | <i>Page</i> |
|---|-------------|
| 55. Cities That Already Have Steam Systems. . . . .   | 167         |
| 56. Heating Degree Days and Population Densities. . . . .                                     | 69          |
| 57. Summary Chart-Comparison of Steam District Heating to Hot Water District Heating. . . . . | 170         |

| <i>Table No.</i>   | <i>Page</i> |
|--|-------------|
| 58. Comparison of the Estimated Capital Cost of District Heating Systems With Other Major Urban Public Works Projects. . . . . | 175         |
| 59. Annualized Capital Costs for Proposed District Heating Systems Under Alternative Capital Recovery Factors . . . . .        | 181         |
| 60. Comparison of Capital Costs for a Heat-Only Coal Boiler and Recovery of Waste Heat From Electricity Generation . . . . .   | 182         |
| 61. U.S. City Size, Population, and Waste Production in 1975 . . . . .   | 183         |
| 62. U.S. Standard Metropolitan Statistical Areas Size, Population, and Waste Production in 1975 . . . . .                      | <b>183</b>  |
| <b>63. Costs of Solar Heat Compared to Heat-Only Coal Boiler for District Heating. . .</b>                                     | <b>184</b>  |
| 64. Subsidized Financing Would Be Required in Some Cases for District Heating To Be Competitive With Fuel Oil. . . . .         | 187         |
| 65. Impact of Fuel Escalation Assumptions on the Break-Even Point in a Proposed District Heating System for Milwaukee. . . . . | 187         |
| 66. How Different Contingencies Can Affect the Total Cost of a Proposed District Heating System for Washington, D.C.. . . . .  | 190         |
| 67. Climactic Influences on Heating Loads for Selected Cities. . . . .   | 191         |

LIST OF FIGURES

| <i>Figure No.</i>  | <i>Page</i> |
|--|-------------|
| 42. Three Major Components of a District Heating System. . . . . | 165         |

| <i>Figure No.</i>  | <i>Page</i> |
|--|-------------|
| 43. Schematic Layout of a Simplified District Heating System. . . . .  | 166         |
| 44. Development of Connected Thermal Capacity (Western Europe). . . . .  | 168         |
| 45. Development of Connected Thermal Capacity (Eastern Europe). . . . .  | 168         |
| 46. Components of a System Cost as a Percentage of Total Costs. . . . .  | 176         |
| 47. Comparison of Fuel Utilization of Electric-Only and Cogeneration Powerplants . . . . .                                 | 177         |
| 48. Power Loss per Heat Recovery for District Heating From Cogeneration as the Supply Water Temperature Increases. . . . . | 177         |
| 49. Thermal Demand Zones and Transmission Supply Lines for the Study City of Detroit, Mich.. . . . .                       | 178         |
| 50. Relationship of Average Heat Density and Customer Size to Costs of District Heat Distribution . . . . .                | 179         |
| 51. Building Retrofit Costs as Building Size Increases. . . . .  | 181         |

LIST OF BOXES

|  | <i>Page</i> |
|--|-------------|
| K. A Citywide System To Be Built in Phases—The District Heating System of St. Paul, Minn.. . . . . | 171         |
| L. A Small Cogeneration and District Heating System for Downtown Trenton. . . . .                  | 171         |
| M. Setbacks . . . The Harvard Medical Area Cogenerating and District Heating Plant. . . . .        | 189         |

## Philadelphia Burner Retrofit

Although a common energy problem in many low-income residences is an inefficient oil burner, the weatherization program has traditionally focused on insulation and storm windows. A pilot program sponsored by DOE in Philadelphia was developed to test a feasible means of upgrading the efficiency of heating equipment on a large scale.<sup>53</sup> Instead of recruiting and training unskilled and semiskilled workers in carpentry and insulation skills, the program enlisted the experience of fuel oil dealers, many of which already perform maintenance on furnaces and boilers.

In the pilot effort, 30 fuel oil dealers in the Philadelphia area retrofitted 145 oil-burning furnaces in Philadelphia during the winter of 1980-81. They installed flame retention burners, corrected unsafe conditions in the heating system, cleaned flue passes, installed clock thermostats, and conducted an instrumented furnace tune-up. The average cost of each job was \$500 and payback was expected in 2 years. On average, furnace efficiency increased by 15 percent, consistent with a predicted fuel savings of **20** percent. The program was designed as an alternative or supplement to using low-income energy assistance funds for weatherization or for direct subsidies.

<sup>53</sup>Department of Energy, "Maximizing Energy Assistance to Low-Income Americans: A Pilot Project to Increase Benefits Through Furnance Retrofits," draft paper (undated), and "Increasing Benefits of Energy Assistance Programs Through Oil Furnance Retrofits," July 1981.

In addition to these two prototype programs, there have been other successful approaches to promote weatherization on a wide scale. In Pennsylvania, the State weatherizes homes at a rate of about 1,200 to 1,400 homes a month, more than any other State, and each year about 14,000 homes are weatherized (see ch. 9). California expects to use Vietnam veterans in its California Conservation Corps to promote weatherization in low-income neighborhoods.

These programs are a worthy start, but they still beg two critical questions that must be answered before the energy needs of the poor are truly addressed. One is the linking of energy retrofit to overall housing condition improvement; the other is improving the energy efficiency of rental units, particularly in large multifamily buildings. On the first count, progress is beginning to be made. Philadelphia, Baltimore, and Pittsburgh have all geared local rehab programs in part to encourage energy retrofits (described in ch. 9). Energy conservation requirements and incentives in HUD programs, such as section 312, section 8, and CDBG-sponsored rehab are also helping to encourage retrofit.

Improving the energy efficiency of rental housing, however, is much more elusive. Except for the Fitchburg campaign there have really been no programs that have reached rental housing in a community in any large-scale fashion. And until this happens, a large percentage of the urban poor will continue to live in energy-inefficient buildings and pay more for energy than is necessary or that they can afford.

| Table No.  | Page |
|--|------|
| 58. Comparison of the Estimated Capital Cost of District Heating Systems With Other Major Urban Public Works Projects. . . . . | 175  |
| 59. Annualized Capital Costs for Proposed District Heating Systems Under Alternative Capital Recovery Factors . . . . .        | 181  |
| 60. Comparison of Capital Costs for a Heat-Only Coal Boiler and Recovery of Waste Heat From Electricity Generation . . . . .   | 182  |
| 61. U.S. City Size, Population, and Waste Production in 1975 . . . . .   | 183  |
| 62. U.S. Standard Metropolitan Statistical Areas Size, Population, and Waste Production in 1975 . . . . .                      | 183  |
| 63. Costs of Solar Heat Compared to Heat-Only Coal Boiler for District Heating. .  | 184  |
| 64. Subsidized Financing Would Be Required in Some Cases for District Heating To Be Competitive With Fuel Oil. . . . .         | 187  |
| 65. Impact of Fuel Escalation Assumptions on the Break-Even Point in a Proposed District Heating System for Milwaukee. .       | 187  |
| 66. How Different Contingencies Can Affect the Total Cost of a Proposed District Heating System for Washington, D.C.. . . . .  | 190  |
| 67. Climactic Influences on Heating Loads for Selected Cities. . . . .   | 191  |

**LIST OF FIGURES**

| Figure No.   | Page |
|--|------|
| 42. Three Major Components of a District Heating System. . . . . | 165  |

| Figure No.   | Page |
|--|------|
| 43. Schematic Layout of a Simplified District Heating System. . . . .  | 166  |
| 44. Development of Connected Thermal Capacity (Western Europe). . . . .  | 168  |
| 45. Development of Connected Thermal Capacity (Eastern Europe). . . . .  | 168  |
| 46. Components of a System Cost as a percentage of Total Costs. . . . .  | 176  |
| 47. Comparison of Fuel Utilization of Electric-Only and Cogeneration Powerplants . . . . .                                 | 177  |
| 48. Power Loss per Heat Recovery for District Heating From Cogeneration as the Supply Water Temperature increases. . . . . | 177  |
| 49. Thermal Demand Zones and Transmission Supply Lines for the Study City of Detroit, Mich.. . . . .                       | 178  |
| 50. Relationship of Average Heat Density and Customer Size to Costs of District Heat Distribution. . . . .                 | 179  |
| 51. Building Retrofit Costs as Building Size Increases. . . . .  | 181  |

**LIST OF BOXES**

|   | Page |
|---|------|
| K. A Citywide System To Be Built in Phases—The 'District Heating System of St. Paul, Minn.. . . . . | 171  |
| L.A Small Cogeneration and District Heating System for Downtown Trenton. .                          | 171  |
| M. Setbacks . . . The Harvard Medical Area Cogenerating and District Heating Plant. . . . .         | 189  |

## Prospects for District Heating

## INTRODUCTION

A discussion of the energy efficiency of buildings in cities is not complete without a discussion of district heating, a system that distributes heat in the form of steam or hot water through a piping network to buildings for space and water heating, or industrial process heat (see figs. 42 and 43). The heat may come from any of a wide variety of sources: waste heat from electric generation, centralized burning of coal or oil, solid waste combustion, or solar or geothermal energy. Under the right conditions, a well-managed district heating system is an energy efficient way of supplying heat to city buildings. As will be shown later in the chapter, the high density characteristic of central cities is almost always an essential requirement for an economically viable district heating system although such high density can occasionally be found in suburban office/shopping complexes, or university campuses outside central cities.

From a national energy perspective, district heating offers, under the right conditions, an

opportunity for saving fuel oil or natural gas by using them more efficiently, or an opportunity to shift to greater use of coal or renewable resources (including municipal solid waste) for supplying heat to buildings. For district heating customers it offers the prospects for slower increases in energy prices. For local governments, district heating can be a tool in the overall task of economic development since it uses local workers for construction and operation, helps attract new development to central city locations and helps to stabilize energy prices for existing buildings. For a utility, a district heating system may provide a way of making money off waste heat from a downtown powerplant, or adding a new product in a time of slower growth in electricity sales.

For all the possible advantages of district heating, the design, construction and successful operation of a district heating system is a formidable undertaking whose complexity should not be underestimated. This chapter discusses the

Figure 42.—Three Major Components of a District Heating System

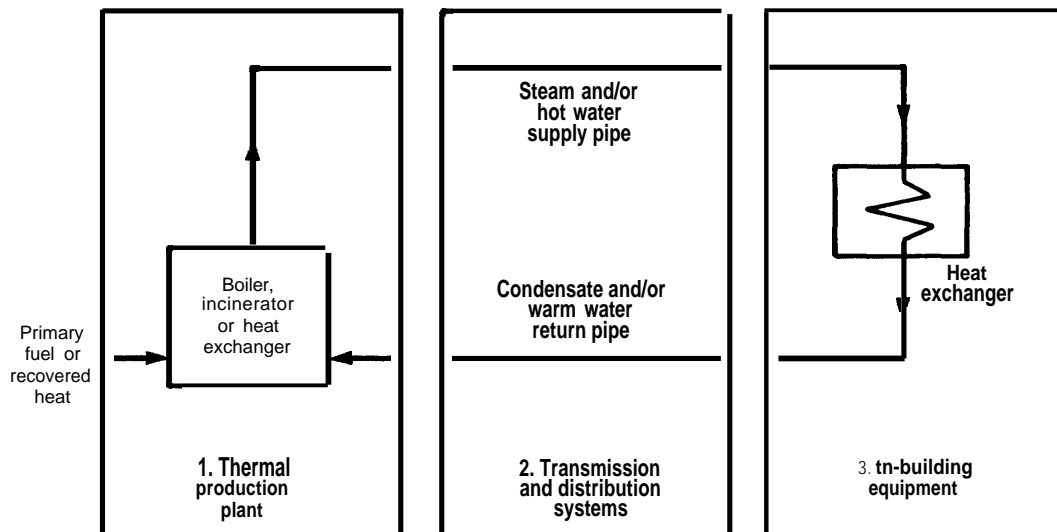

SOURCE W. Pferdehirt and N. Kron, Jr., "District Heating From Electric Generating Plants and Municipal Incinerators: Local Planner's Assessment Guide," Argonne National Laboratory, Argonne, Ill., Energy and Environmental Systems Division for the U.S. Department of Energy, prepublication copy, AN L/CNSV-1 2, November 1980.



Figure 43.—Schematic Layout of a Simplified District Heating System

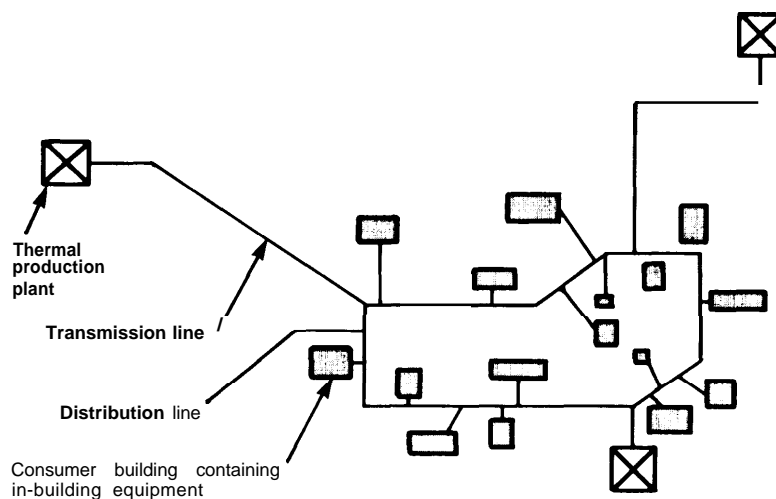

SOURCE: W. Pferdehirt and N. Kron, Jr., "District Heating From Electric Generating Plants and Municipal Incinerators: Local Planner's Assessment Guide," Argonne National Laboratory, Argonne, Ill., Energy and Environmental Systems Division for the U.S. Department of Energy, prepublication copy, AN UC NSV-12, November 1980.

conditions for success of a district heating system both from the perspectives of a city or State government or utility developing and financing

a district heating system and from the perspective of future customers who are invited to hookup to such a system.

## CONTEXT FOR U.S. DISTRICT HEATING IN THE 1980's

District heating in the United States is not a new idea. The first district heating system using a central heat source connected to a steam pipe was constructed over 100 years ago in Lockport, N.Y. Beginning in the 1890's there was a rapid growth of district heating systems using exhaust steam from noncondensing steam-electric powerplants to heat buildings in nearby business districts. Changes in electric generating technology, however, soon reduced the opportunities for district heating as electric generating plants grew larger, with smaller generating losses, and were moved further from densely settled areas.

As small close-in generating plants were closed down, many district heating systems lost their sources of inexpensive waste heat and had to rely on far more expensive steam-only plants. Prices for steam increased and drove away customers. By the late 1920's, economically failing systems began to close; the decline continued through World War II as inexpensive oil and

natural gas became available for heating purposes.

Since then, the number of district heating systems in the United States has remained relatively stable. Fifty-nine of them were recently surveyed in a study for the Electric Power Research Institute (EPRI).<sup>1</sup> (The study excluded the many systems serving military bases, university campuses, and industrial parks.) The four largest U.S. systems (in New York, Philadelphia, Detroit, and Boston) and some other typical systems are shown in table 55.

The statistics in the table tell a sad tale. Only Boston Edison earned a minimally adequate return on fixed assets of 10.3 percent in 1978. Baltimore Gas & Electric earned only 1.8 percent and Detroit Edison lost money on its system.

<sup>1</sup> "Dual Energy Use Systems—District Heating Survey," prepared by EUS, Inc., Pittsburgh, Pa., with Hittman Associates, Inc., Columbia, Md., for the Electric Power Research Institute, EM-1 436, July 1980.

**Table 55.—Cities That Already Have Steam Systems**

| City   | Ownership of system | Percent of steam produced by cogeneration | Most recent peak steam sendout (10 <sup>3</sup> lb/hr) | Losses in system, percent | Number of customers           | Fuels used, percent |            |             | Return on fixed assets, percent | Current average (1978) price of steam (\$/10 <sup>3</sup> lb) <sup>a</sup> |
|--|---------------------|---|--|---------------------------|-------------------------------|---------------------|------------|-------------|---------------------------------|--|
|  |                     |   |  |                           |                               | Coal                | Resid. oil | Natural gas |                                 |  |
| New York — Consolidated Edison, . . . . .                            | Investor            | 55  | 11,663 actual (14,983 maximum possible)                | 16                        | 2,285                         | 0                   | 99         | 1           | 7.4                             | 6.76   |
| <b>Chicago — Commonwealth Edison, . . . . .</b>                      | Investor            |   | (Closed July 5, 1979 — last 4 customers disconnected)  |                           |                               |                     |            |             |                                 |  |
| Philadelphia — Philadelphia Electric, . . . . .                      | Investor            | 70  | 2,431 (3,857)  | 12                        | 670                           |                     | 100        |             | 5.8                             | 5.84   |
| Detroit — Detroit Edison, . . . . .                                  | Investor            | 38  | 1,724 (2,931)  | 18                        | 843                           | 4                   | 9 (#2)     | 87          | -7.0                            | 5.26   |
| Boston — Boston Edison, . . . . .                                    | Investor            | 0   | 1,975 (2,340)  | 21                        | 465                           |                     | 76         | 24          | 10.3                            | 7.05   |
| Baltimore — Baltimore Gas and Electric, . . . . .                    | Investor            | 0   | 819 (990)  | 14                        | 720                           |                     | 49 (#2)    | 51          | 1.8                             | 5.47   |
| Indianapolis — Indianapolis Power & Light, . . . . .                 | Investor            | 46  | 1,428 (1,722)  | 15                        | 703                           | 91                  | 8 (#2)     | 1           | 4.5                             | 4.21   |
| Lansing — Lansing Board of Water & Light, . . . . .                  | (Large) municipal   | 0   | 260 (400)  | 12                        | 488                           | 100                 |            |             | — (loss of \$245,000 in 1978)   | 3.66   |
| Virginia, Minn. — Virginia Department of Public Utilities, . . . . . | (Small) municipal   | 79  | 266 (270)  | 42                        | 3,301 (70 percent connection) | 100                 |            |             | 75.0 <sup>c</sup>               | 4.70   |
| Piqua, Ohio — Piqua, Ohio Municipal Power System, . . . . .          | (Small) municipal   | 100                                       | 42 (80)  | 6.5                       | 8                             | 100                 |            |             | Not available                   | 2.10   |

<sup>a</sup>They do not include generating plant in net assets of the steam system — they allocate it to the electric system  
<sup>b</sup>One thousand lbs of steam has a heat content of about 1 million Btu  
 NOTES <sup>1</sup>Four largest systems in the United States are New York, Philadelphia, Detroit, and Boston New York is by far largest in the United States and is one of the largest in the world  
<sup>2</sup>Baltimore is a successful system with predominantly commercial customers  
<sup>3</sup>Indianapolis is a successful system with a large number of industrial customers  
<sup>4</sup>Chicago's system has been closed, they lacked interest in D/H and cogeneration and pushed electric heating in new buildings and nuclear power  
 SOURCE "Dual Energy Use Systems — District Heating Survey," prepared by EUS, Inc., Pittsburgh, Penn., with Hittman Associates, Inc. Columbia, Md. for the Electric Power Research Institute, EM 1436, July 1980

The Chicago system closed down in 1979. System losses are high; little advantage is taken of waste heat from cogeneration or coal generation of steam. Many rely heavily on expensive oil or natural gas for steam production. Despite the low rate of return, steam in most systems had a price that made it considerably more expensive than natural gas or heavy fuel oil in 1978 even assuming that the steam was used more efficiently.<sup>2</sup>

<sup>2</sup>Assuming 80 percent efficiency steam at \$5 per ton would produce heat at about \$6.25 per million Btu. At their 1978 average prices (according to the DOE Monthly Energy Review, April 1981) comparable prices for heat assuming 60 percent efficiency would have been: natural gas \$4.43 per million Btu; No. 6 heavy fuel oil \$3.37 per million Btu; and No. 2 light fuel oil \$5.93 per million Btu.

There is a more discouraging note, however, that is not revealed by the statistics in table 55 but which can be illustrated by the last decade of operation of the Consolidated Edison (Con Ed) steam system in New York City, "the largest cogenerator of electricity and byproduct steam in the non-Communist world,"<sup>3</sup> Between 1970 and 1978 Con Ed lost 12 percent of its customers and 17 percent of its peak sales volume (in 1972). Over the same period the company raised the price for steam by 345 percent while the price for No. 2 home heating oil increased

<sup>3</sup>Edward F. Renshaw, "Public Utilities and the Promotion of District Heating," *Public Utilities Fortnightly*, July 17, 1980.

by 173 percent, Relative to fuel oil the Con Ed system lost substantial competitive ground.

The experience in Europe with district heating has been completely different, Countries in both Western and Eastern Europe have greatly increased their district heating capacity since 1960, as can be seen in figures 44 and 45.<sup>4</sup> Virtually all of the European systems use hot water rather than steam to send thermal energy to buildings. Constructed more recently, they have taken advantage of improvements in technology that allow the more effective hot water systems. Sweden, with its population of 8 million people

<sup>4</sup>*Cogeneration of Electricity and Useful Heat*, B. W. Wilkinson, and R. W. Barnes (eds.) (Boca Raton, Fla.: CRC Press, Inc., 1980).

**Figure 44.—Development of Connected Thermal Capacity (Western Europe)**

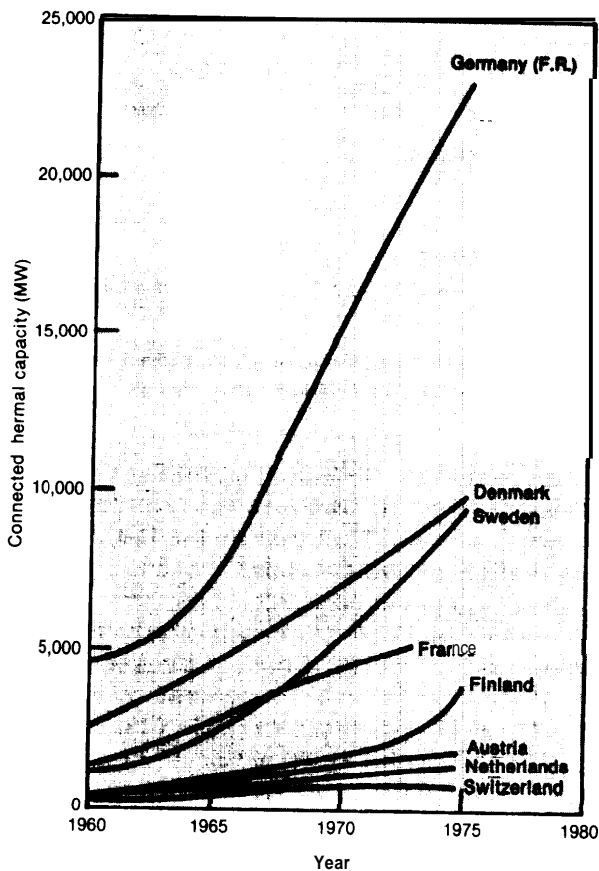

SOURCE: *Cogeneration of Electricity and Useful Heat*, B. W. Wilkinson and R. W. Barnes (eds.) (Boca Raton, Fla.: CRC Press, Inc., 1980).

**Figure 45.—Development of Connected Thermal Capacity (Eastern Europe)**

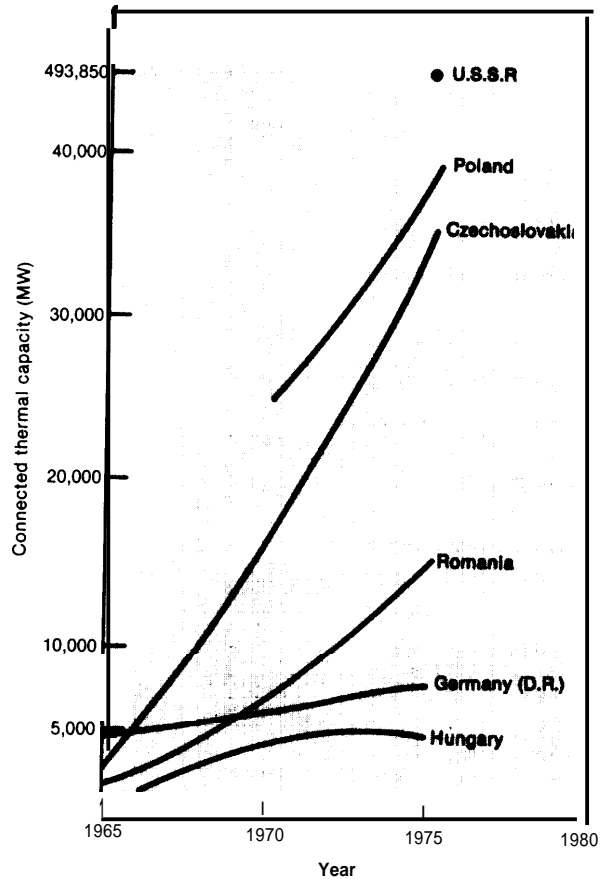

SOURCE: *Cogeneration of Electricity and Useful Heat*, B. W. Wilkinson and R. W. Barnes (eds.) (Boca Raton, Fla.: CRC Press, Inc., 1980).

has an installed capacity of **12,000** MW of district heating compared to the U.S. capacity of 7,400 MW. Sweden plans to almost triple this capacity by 2000, to 30,000 MW. In Sweden, as well as other Scandinavian countries, the majority of new electric generating plants are cogenerators, and urban-waste incinerators are constructed routinely to supply waste heat to district heating systems.

The greater success of district heating systems in Scandinavia and Germany than in the United States cannot be explained by differences in climate, density, or heating demand per capita. European cities where district heating has thrived are comparable to American cities where district heating either does not exist or has floundered, Stockholm is quite comparable

to Buffalo; Chicago is much denser and demands more heat than Hamburg; and Detroit is quite comparable to West Berlin (see table 56).

The theoretical advantages of European-style hot water systems over American-style steam are increasingly well understood in the United States and all new systems known to be under consideration would use hot water. The advantages and disadvantages of steam and hot water systems are summarized for convenience in table 57. One of the most important advantages is that plastic transmission and distribution pipes can be used for hot water while steel pipe must be used for the higher temperature steam. Plastic pipe is itself less expensive than steel pipe, and is far easier to maintain because it does not corrode. The lower temperature of hot water and the lack of pipe corrosion also reduces the likely thermal losses of the system from the very high (15 to 45 percent) losses from steam systems to much more modest losses of 5

to 15 percent from hot water systems.<sup>5</sup> For this reason heat sources for hot water systems may be practical up to 70 miles from the city or industry where the hot water is to be used.

At present, no major district heating system is under construction in the United States. One downtown system, for St. Paul, Minn., is in an advanced stage of planning and is described in more detail in box K. Construction of much smaller system, in Trenton, owned by a group of private investors, is about to begin (see box L). The rest of the discussion in this chapter is based on preliminary feasibility studies for district heating systems in other major cities. Most of the analysis has been done by Argonne National Laboratory.

<sup>5</sup>Private communication with Tom Casten, president, Cogeneration Development Corp.; EPRI, "Dual Energy Use Systems," op. cit.; and H. S. Geller, "Thermal Distribution Systems and Residential District Heating," Princeton University Center for Energy and Environmental Studies, No. 97, August 1980.

**Table 56.—Heating Degree Days (above 65° F) and Population Densities**

| City                               | Heating degree days | Total population (10 <sup>3</sup> ) | Population density, people/acre | Annual per capita residential space heat consumption (10 <sup>6</sup> Btu) |
|------------------------------------|---------------------|-------------------------------------|---------------------------------|--|
| 1. Helsinki <sup>a</sup> . . . . . | 8,400               | 750                                 | 2.4                             | 17.1   |
| 2. Minneapolis . . . . .           | 8,400               | 434                                 | 12.3                            | 42.7   |
| 3. Stockholm . . . . .             | 8,100               | 750                                 | 16.2                            | 21.8   |
| 4. Buffalo . . . . .               | 7,100               | 463                                 | 17.5                            | 36.1   |
| 5. Malmö . . . . .                 | 6,700               | 254                                 | 9.5                             | 18.0   |
| 6. Hamburg . . . . .               | 6,300               | 1,800                               | 9.7                             | 19.9   |
| 7. Denver . . . . .                | 6,300               | 515                                 | 8.4                             | 32.3   |
| 8. Chicago . . . . .               | 6,200               | 3,367                               | 23.6                            | 31.3   |
| 9. Detroit . . . . .               | 6,200               | 1,511                               | 17.1                            | 31.3   |
| 10. West Berlin . . . . .          | 6,100               | 2,000                               | 16.9                            | 19.0   |
| 11. New York . . . . .             | 5,000               | 7,895                               | 41.3                            | 25.6   |

<sup>a</sup>Metropolitan Area.

NOTE. European cities listed are known to have extensive district heating systems.

SOURCE J. Karkheck, J. Powell, and E. Beardsworth, "Prospects for District Heating in the United States," *Science*, vol 195, Mar 11, 1977, pp. 948-955

**Table 57.—Summary Chart-Comparison of Steam District Heating to Hot Water District Heating**

| System                     | Advantages  | Disadvantages  |
|----------------------------|---|--|
| Steam district heating     | <ol style="list-style-type: none"> <li>1. Pumps not required</li> <li>2. Can be a one pipe system with no return</li> <li>3. Retrofit of old urban steam buildings may be easier</li> </ol>   | <ol style="list-style-type: none"> <li>1. Piping range of 1 to 2 miles, 3 miles maximum</li> <li>2. If steam is extracted from a cogenerator, a great deal of electricity is sacrificed</li> <li>3. Steel pipes are required — they are expensive and they corrode</li> <li>4. Water must be conditioned to prevent mineralization</li> <li>5. If condensate is not returned (it usually is not), water, water conditioning, and low grade energy are wasted</li> <li>6. Use of high temperature steam for space heat/service water heating is a poor energy end use match</li> <li>7. High heat loss during distribution (15-45 percent)</li> <li>8. Piping, boiler, personnel codes are stringent; steam is not as safe as hot water</li> <li>9. Installation is difficult — pitched piping, steam traps, pipe expansion, manholes</li> <li>10. Maintenance costs are higher than hot water systems</li> <li>11. Metering energy use is difficult</li> <li>12. Very susceptible to miss-sizing or loss of large customer</li> <li>13. Difficult to operate under conditions of varying load</li> </ol> |
| Hot water district heating | <ol style="list-style-type: none"> <li>1. Piping range of 15 miles, possibly up to 70 miles</li> <li>2. Less cogenerator electricity sacrifice than for steam</li> <li>3. Plastic pipes can be used — less expensive, no corrosion</li> <li>4. Water need not be conditioned; if it is, closed loop anyway</li> <li>5. Closed loop, so water is not wasted nor is low grade energy</li> <li>6. Good energy end use match</li> <li>7. Low heat loss during transmission/distribution (5-15 percent)</li> <li>8. Construction/operation codes easier to meet; relatively safe</li> <li>9. installation, retrofit to buildings generally easier than steam</li> <li>10. Lower maintenance costs than steam systems</li> <li>11. Metering energy use is relatively easy</li> <li>12. Not as susceptible to miss-sizing as steam systems are</li> <li>13. Easy to operate under conditions of varying thermal load</li> <li>14. Hot water can be stored</li> </ol> | <ol style="list-style-type: none"> <li>1. Pumps are required — system balancing is important</li> <li>2. System needs two pipes</li> <li>3. Cannot provide high pressure steam if a customer on the circuit requires it — only can act as preheat</li> </ol>   |

SOURCE: Office of Technology Assessment

### **Box K.-A Citywide System To Be Built In Phases- The District Heating System of St. Paul, Minn.\***

In July 1981, the District Heating Development Corp. of St. Paul, Minn., signed its first 30-year contract to provide 3 MW of thermal energy to a major district heating customer. If all goes well and enough customers also sign 30-year contracts, about \$35 million of revenue bonds will be marketed in the winter of 1982 and the country's largest hot water district heating system will be launched.

The first phase of the project will provide 165 MW of thermal energy to large customers—State government buildings, hospitals, and private office buildings in downtown St. Paul—and is planned to cost a total of \$77 million. The project is a model of public-private corporation. Of the total, \$9 million will be contributed by the Northern States Power Co. to convert a powerplant to provide hot water as well as electricity. Another estimated \$23 million will be spent by building owners to convert their buildings to use district hot water. Financing assistance for building owners with poor access internal funds is being arranged by the St. Paul Port Authority. The rest of the funds for the district heating system will come from the city. To supplement the revenue bonds and permit lower cost debt service there is a \$7.5 million HUD/UDAG grant and a \$2.5 million loan from the city. In all, the effective debt service cost of the city portion of the financing will average about 10.9-percent annual interest.

The District Heating Development Co. is a nonprofit corporation whose board is chaired by the mayor of St. Paul and includes representatives of the Northern States Power Co., business and labor groups, customers, and State government. The chief executive officer, Hans Nyman, has experience in European district heating. Oak Ridge National Laboratory managed the initial feasibility study for the project and continues to provide technical management.

The district heating system—the design of which drew heavily on techniques developed in Europe—will use relatively low-temperature pressurized hot water (250° F) compatible with inexpensive prefabricated polyurethane pipe.

Transmission pipes for the system are large enough for a second phase construction of an additional 145 MW of thermal energy bringing the total to 300 MW. The total cost of the second phase of the system is estimated to be an additional \$2 million to \$3 million. There are also preliminary plans to expand the system to nearby residential areas and across the Mississippi River to Minneapolis.

\*James O. Kolb, St. Paul *District Heating Demonstration Project: Economic Feasibility and Implementation Strategy*, presentation to Integrated Energy Systems Task Force Aug. 11, 1981, and conversation with Monica Westerlund of the St. Paul District Heating Development Corp., October 1981.

### **Box L.-A Small Cogeneration and District Heating System for Downtown Trenton\***

Ground will be broken in the fall of 1981 for a privately owned cogeneration and district heating system which is expected to provide heat to 25 large buildings including the State of New Jersey office buildings and the Mercer Medical Center, a large hospital complex. The feasibility of the project was originally determined under a district heating study grant to the city from the Department of Energy. A private partnership called Trenton District Energy Co. will own the system and will be managed by another private company, Cogeneration Development Corp. Financing includes \$10 million of tax-free New Jersey industrial revenue bonds, a \$1 million grant from the Department of Energy, a \$4 million Urban Development Action Grant (UDAG) loan at 20 years initially at 6-percent interest then adjusted to the market interest rate and the remaining \$3 million to \$4 million to be raised from limited partners in a syndication. The project will produce pressurized hot water at 320° to 400° F and electricity from medium-speed diesel engines designed to use both fuel oil and natural gas. The pressurized hot water will be dispatched first to customers needing low-pressure steam and then on to customers needing lower temperature hot water. The company will sell electricity to Public Service Electric & Gas at an agreed-upon price formula of electricity.

\*Private communication with Tom Casten, President, Cogeneration Development Corp.

## CONDITIONS FOR VIABILITY OF A DISTRICT HEATING SYSTEM IN THE UNITED STATES

Before beginning a detailed discussion of the technical and economic feasibility of district heating, it is useful to understand the framework within which a district heating system may be said to be successful. The formula for viable district heating will vary based on whether it is privately owned or publicly owned, subsidized or unsubsidized. All the subsequent economics will follow accordingly.

If a district heating system is unsubsidized and privately owned, by a utility or group of investors, it must raise all its capital in the unsubsidized financial markets, pay all operating costs without subsidy, pay all Federal, State, and local taxes on income, sales, and property and still charge a low enough price for hot water that a large enough number of customers are willing not only to buy hot water (rather than oil, gas, coal, or electricity) but also (in many cases) to retrofit their buildings so that they can use hot water (or occasionally low-pressure steam).

As in any business, planning to make this happen is a risky and tricky problem. District heating shares with some other major investments, such as new towns and mass transit systems, the characteristic that a major fraction of the **total cost is the initial capital cost before there are any revenues. Unless contracts with prospective customers are secured in advance there is no guarantee that enough customers will actually hookup to the system to cover the fixed capital costs. [In dealing with prospective customers,** not only must the hot water price be right but a hookup must be perceived as convenient and beneficial given the extra trouble of converting from one system to another system.

Nonprofit and/or subsidized district heating systems, on the other hand, can offer hot water at prices below full for-profit unsubsidized systems. Nonprofit systems can break even; they do not have to provide a return on investment. They may be exempt from Federal, State, or local taxes. The capital costs of district heating can be subsidized by using tax-free bonds such as *general obligation bonds* (backed by the taxing authority of a local government) or *revenue*

bonds (to be repaid from project revenues) or by guaranteeing taxable bonds such as *industrial revenue bonds*. The subsidy will take the form of lost tax revenue to the Federal Government or increased risk to the local government. The subsidy may also take the form of an outright grant from Federal or State government to pay part of the capital costs of the district heating project,

Once the district heating system has been built, however, it is the interaction among its own prices, the prices of competing fuels and its customers' preferences that determines if the system can charge high enough prices to enough customers to cover its full annualized capital cost and operating cost. A vicious cycle may set in if the system has too few customers to cover its full costs. Raising prices to the remaining customers to make up for the shortfall may only succeed in reducing the number of customers still further. It is this kind of vicious cycle that has befallen the Con Ed steam system and most of the mass transit systems in the major U.S. cities. Once a district heating system falls into such a vicious cycle then its operating costs might have to be subsidized at least until the prices of competing sources of fuel rise high enough to encourage new district heating system customers or bring back the defecting ones. Without a requirement for customers to hookup, the potential of just such a vicious cycle must be considered in the planning for every district heating project.

It is in this context that the capital costs, operating costs, and finance of district heating systems must be considered. If district heating systems, conventionally financed, cannot price their heat output to be competitive with oil, gas, or electricity used efficiently to run heat pumps, then they must be subsidized. The subsidy may be justified for purposes of stabilizing local energy prices, influencing local development patterns, clean air, local jobs, or saving oil imports. The size of the subsidy can be estimated and compared to the value of these potential goals.

## CAPITAL COSTS OF DISTRICT HEATING

District heating is a very capital-intensive energy source which, in effect, substitutes the cost of capital for the cost of fuel. The overall capital cost and how it is financed are the major, and virtually the only, influences on the competitive viability of district heating. This is particularly true in periods such as 1980 and 1981 when high real interest rates and expected high inflation rates combine to make the costs of financing any capital investments *very high*.

As public works projects, **citywide district heating systems** rank among the most expensive, far more expensive than major projects to repair bridges, replace storm sewers, or replace fleets of buses. In size and scope, they are comparable mainly to mass transit projects. To place district heating in perspective, table 58 shows some estimated costs of typical urban public

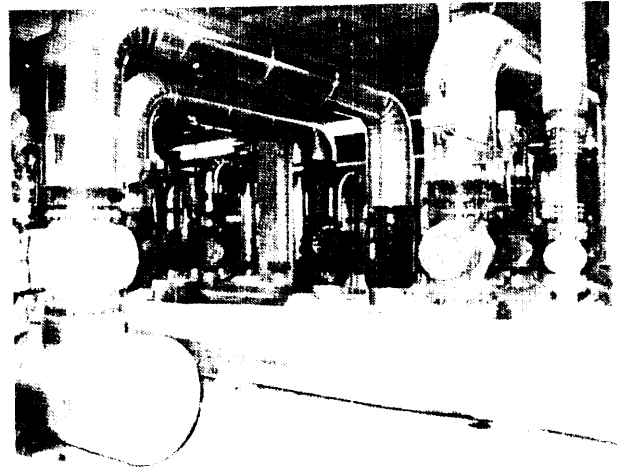

b) Distributor arrangement for high-temperature water

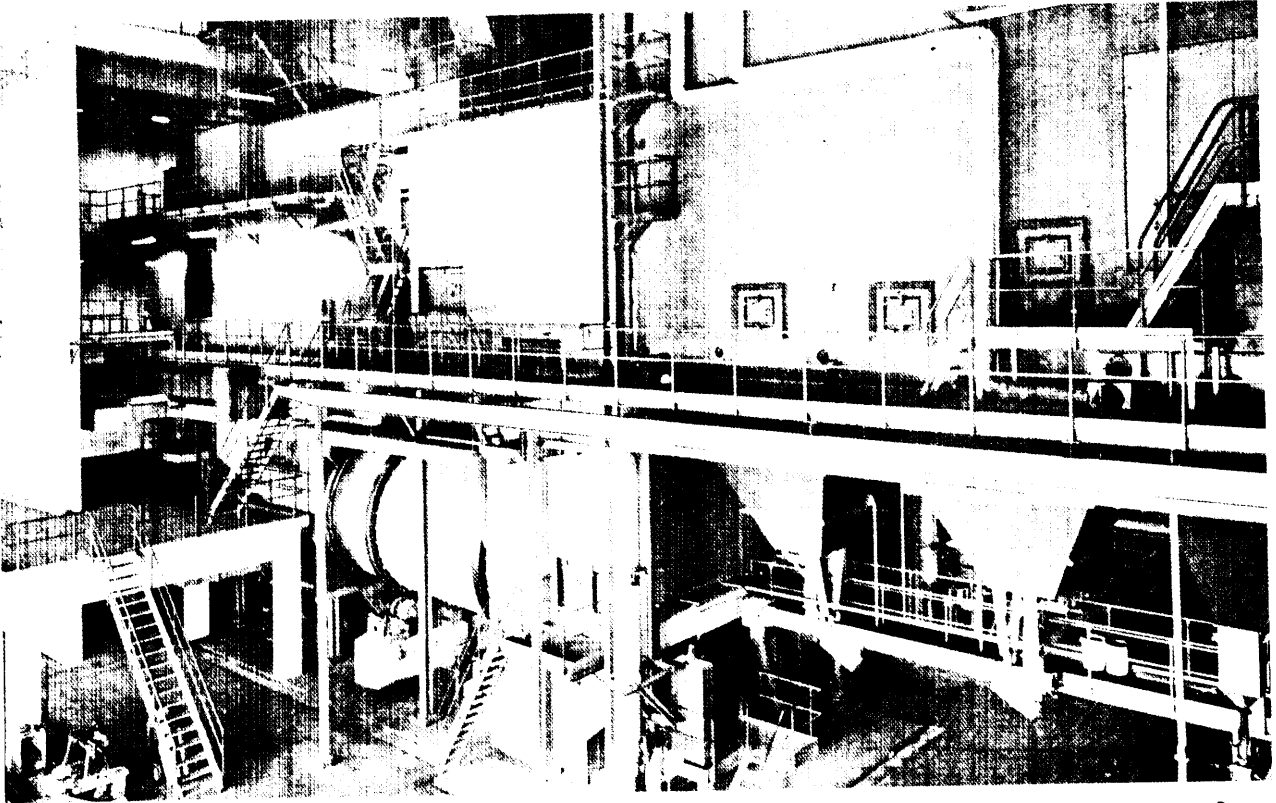
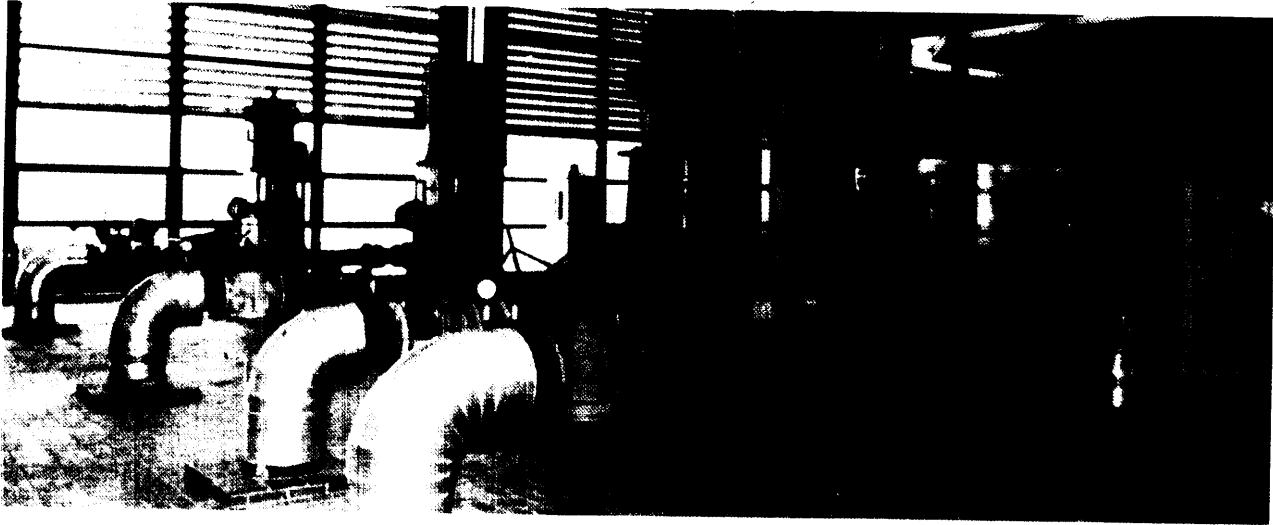

Photo credits: Ramboll and Hannemann consulting engineers, Denmark

Capital equipment for a district heating system in Denmark using heat from municipal solid waste include:  
a) Furnace and boiler for incineration of rubbish





c) Main pumps in heating station

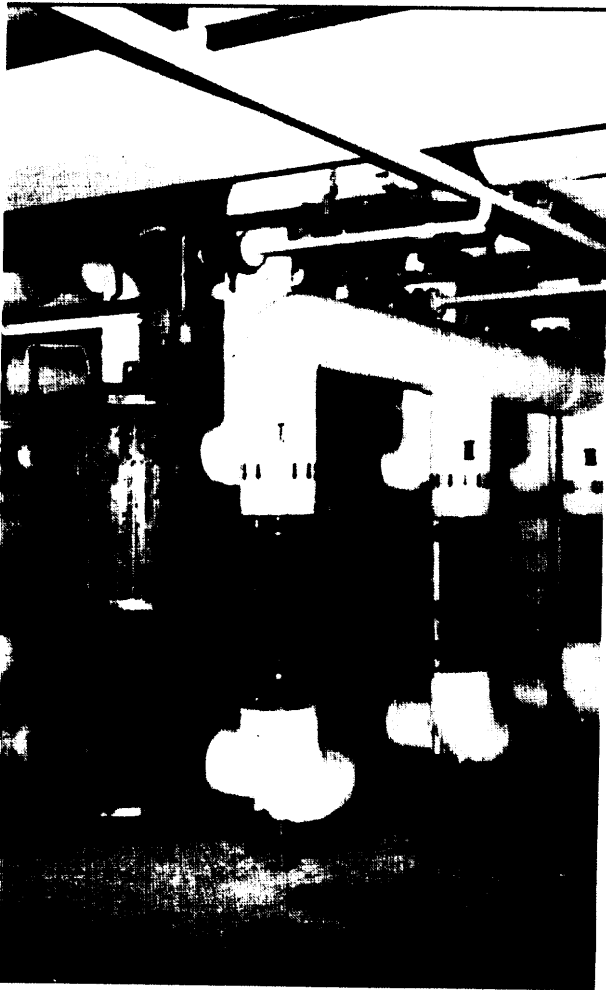

d) Heat exchanger arrangement at tapping point



e) High-temperature district heating pipe during construction

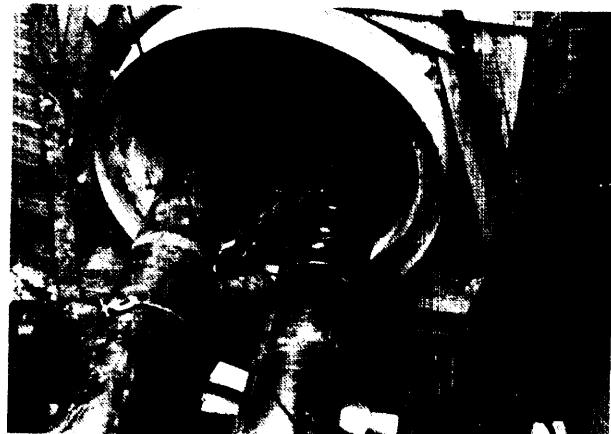

*Photo credits: Ramboll and Hannemann consulting engineers, Denmark*

f) Concrete duct under mainroad

**Table 58.—Comparison of the Estimated Capital Cost of District Heating Systems With Other Major Urban Public Works Projects**

|  | Capital cost<br>millions of dollars |
|--|-------------------------------------|
| 1. Purchasing 100 new buses for transit system . . . . .   | 15 <sup>a</sup>                     |
| 2. Storm sewer budget for 5 years for the city of Tampa . . . . .  | 18.5 <sup>b</sup>                   |
| 3. First phase of district heating system for downtown St. Paul . . . . .  | 77 <sup>c</sup>                     |
| 4. Repair of the Queensboro Bridge in New York City . . . . .  | 120 <sup>d</sup>                    |
| 5. Waterpipe system replacement in Lynn, Mass. (170 miles) . . . . .   | 500 <sup>e</sup>                    |
| 6. Buffalo, N.Y. subway system . . . . .   | 450 <sup>f</sup>                    |
| 7. City-wide district heating system serving central business district plus 1 to 4 family residential area of Minneapolis-St. Paul . . . . . | 1,200 <sup>g</sup>                  |
| 8. Washington, D.C. district heating system . . . . .  | 895-1,985 <sup>h</sup>              |
| 9. Cleveland, Ohio district heating system . . . . .   | 1,248-2,882 <sup>h</sup>            |
| 10. Milwaukee, Wis. district heating system . . . . .  | 1,247-2,856 <sup>h</sup>            |
| 11. Washington, D.C. subway system (101 miles) . . . . .   | 8,200 <sup>i</sup>                  |

SOURCES <sup>a</sup>Telephone conversation with General Motors, Public Affairs Off Ice, Washington, D C , Mar 17, 1981

<sup>b</sup>City of Tampa Capital Improvements Budget for Oct 1, 1981 through Sept 30, 1986

<sup>c</sup>J O Kolb "St Paul District Heating Demonstration Project Economic Feasibility and Implementation Strategy," presentation to Integrated Energy Systems Task Group Aug 11, 1981

<sup>d</sup>Engineering News Review, "Aging Landmark Stands to be Fixed " ENR Feature, Jan 31, 1986

<sup>e</sup>Presentation by Jack Casey, Director, Public Works, city of Lynn, to the World Bank, "On Repairing Aging Water Mains," Jan 10, 1979

<sup>f</sup>Telephone conversation with Tom Murphy, Mayor's office, Buffalo

<sup>g</sup>Peter Margen, Kyele Larsson, Lars-Ake Cronholm, Jan-Erik Marklmo, Studsvik Energiteknik AB District Heating/Cogeneration Application Studies for the Minneapolis/St Paul Area, Oak Ridge National Laboratory, Oct 1979

<sup>h</sup>D J Santini, A A Davis and S M Marder "Economic and Technical Analysis of Retrofit to Cogenerating District System. North Central Cities, Argonne National Laboratory, Argonne, Ill ANUCNSV-TM-11, June 1979

<sup>i</sup>Telephone conversation with Metro Public Affairs Off Ice, Washington, D C , Mar 11, 1981

works projects compared with the estimated cost of the proposed St. Paul district heating system and several systems for other cities for which preliminary cost estimates have been done.

The most likely prospect for a viable district heating system is one that uses waste heat from an electric generating plant for its heat source. This section first analyzes the theoretical capital costs of a hot water district heating system that

uses waste heat, partly because the most analytical work has been done on these kinds of systems. Many other sources of heat can be used, however, such as nonelectricity generating coal combustion, heat from municipal solid waste, solar ponds or collectors, and geothermal energy. Less is known about the actual and potential costs of such systems, but what is known is discussed in the next section. There is also a brief discussion of district cooling and of converting existing steam systems to hot water.

The choice of an assumption about capital recovery rate is also critical to assessing the viability of a district heating system. In the first part of this section, the capital costs of different proposed systems are analyzed assuming a *capital/recovery rate*<sup>6</sup> of 0.15 which corresponds to the midrange of rates of return allowed for regulated utilities. This is probably the lowest capital recovery rate possible if the district heating system is to be unsubsidized and owned by private investors. In 1980-81 regulated utilities requested rates of return ranging from 16 to 18 percent.<sup>7</sup> Unregulated private investors typically demand higher rates of return, equivalent to a capital recovery rate of 0.20 or 0.25. Since the financing assumption is critical to the viability of district heating, there is a full discussion later in this section of the impact of assumed capital recovery factors on the annualized costs of district heating.

*Components of capital cost.* There are five chief components of the capital cost of a district heating system using waste heat from a powerplant:

1. The cost of retrofitting the powerplant to produce heat.
2. The cost of replacing the lost generating capacity when the powerplant is retrofitted to produce electricity and hot water. (This is not a cost for all systems.)

<sup>6</sup>The capital recovery rate is defined as the annual rate at which the initial investment is amortized. It includes interest and repayment of principal and is the same each year over a fixed term. A capital recovery rate of 0.15 would amortize an investment over 20 years at an interest rate of something over 14 percent.

<sup>7</sup>Edison Electric Institute "Comments," presented at the Federal Energy Regulatory Commission's Public Conference on the Financial Condition of the Electric Utility Industry in the United States, Mar. 6, 1981, p. 5.

3. The cost of the system of large pipes to transmit the hot water from the heat source to the general area(s) where it will be used.
4. The cost of the system of smaller pipes to distribute the hot water to individual customers.
5. The cost of retrofitting some buildings to use district hot water.

By far the largest of these five cost components are the transmission and distribution system costs. Together they average 55 to 60 percent of the total capital cost of possible district heating systems for nine cities as estimated by Argonne Labs (see fig. 46). For the five Midwestern cities with somewhat lower density, distribution costs were nearly double transmission costs. For the four Northeastern cities, the higher share of transmission costs reflected the generally longer distances that waste heat had to be transmitted from the powerplant sources.<sup>8</sup>

Not all district heating systems must include one of the five costs—the cost of replacing the lost electric generating capacity. The proposed system for St. Paul, for example, does not because waste heat from the electric generating

<sup>8</sup>The four Northeastern cities are Baltimore, Boston, Philadelphia, and Washington. The five Midwestern cities are Chicago, Cleveland, Detroit, Milwaukee, and St. Louis.

plant will only be used on an interruptible basis when the full generating capacity is not required. At times of peak demand for electricity, when the full generating capacity is needed, heat for the district system will be supplied from a standby boiler from the existing steam district heat system in downtown St. Paul which has been purchased by the new hot water district heating company.

Some district heating systems may not cover all or any of the costs of retrofitting buildings to accept district hot water (or district steam). Since (as is discussed below) this is a significant barrier to building hookups, it is likely that most district heating systems will at least arrange favorable financing for building owners in order to ensure the maximum number of customers to cover the fixed cost of the system.

The rest of this section describes each of the major components of capital cost of a district heating system.

**Capital Costs of Waste Heat Recovery—Plant Retrofit and Replacing Lost Generating Capacity.** Waste heat recovery can be a small or a fairly large share of total district heating system cost, depending on whether much electric generating capacity is lost, and whether it has to be

**Figure 46.—Components of a System Cost as a Percentage of Total Costs**

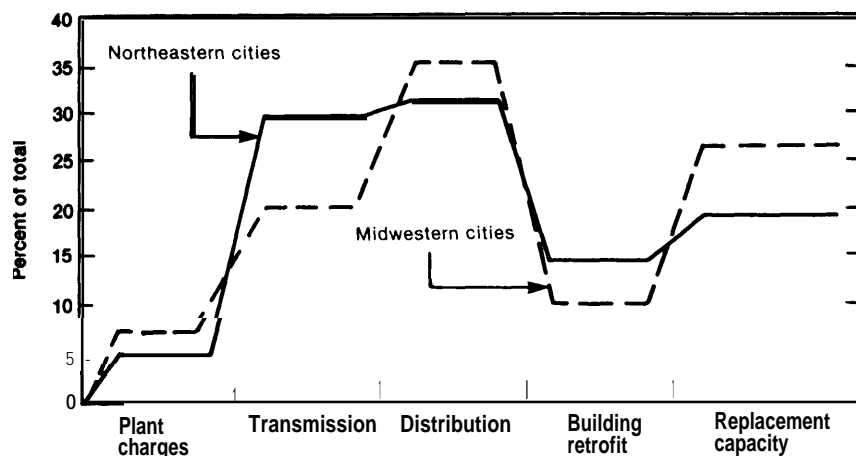

SOURCE: D. J. Santini, and S. S. Bemon, "Feasibility of District Heating and Cooling of Core Areas of Major Northern Cities by Cogeneration from Central Station Powerplants", paper presented at Northeastern Regional Science Association Meetings, Amherst, Mass., May 1979.

replaced. In the diagram in figure 47, the electricity-only powerplant uses 33 percent of the heat in the fuel for electricity and wastes the rest. The cogeneration plant, on the other hand, used only 25 percent of the fuel for electricity, but makes available another **55 percent of the fuel for heat for district heating**.

How much electric generating capacity must be sacrificed to make waste heat available for district heating depends both on the type of co-generating equipment and on the temperature of the waste heat that is being removed. The higher the temperature of the waste heat, the greater the loss in electric-generating capacity. Figure 48 shows that for steam at 330° F the loss in generating capacity is **close to 20 percent of the heat recovery**. As the temperature drops to 150° F, the loss in generating capacity shrinks dramatically.

**Figure 47.—Comparison of Fuel Utilization of Electric-Only and Cogeneration Powerplants**

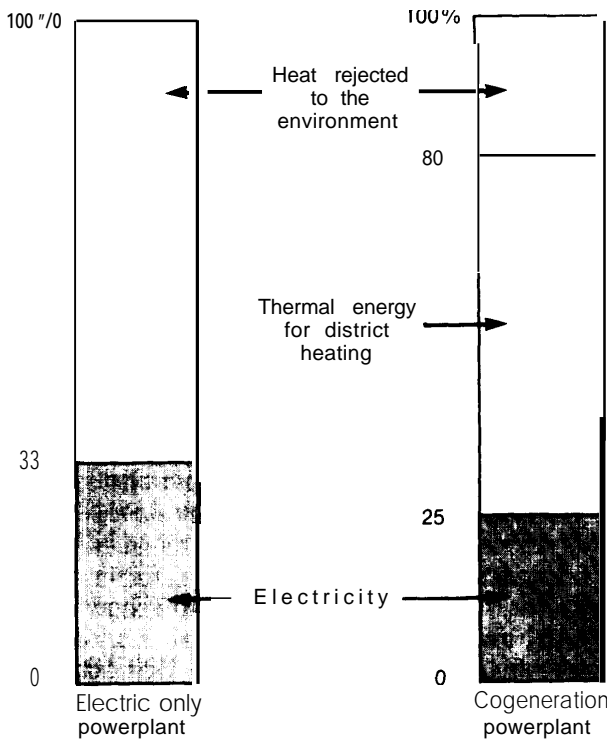

SOURCE: R. E. Sundberg and H. O. Nyman, "District Heating/Cogeneration Application Studies for the Minneapolis-St. Paul Area: Methods and Cost Estimates for Converting Existing Buildings to Hot Water District Heating," Oak Ridge National Laboratory, Oak Ridge, Tenn., ORNL/TM-6830/P4, October 1979.

**Figure 48.—Power Loss per Heat Recovery for District Heating From Cogeneration as the Supply Water Temperature Increases**

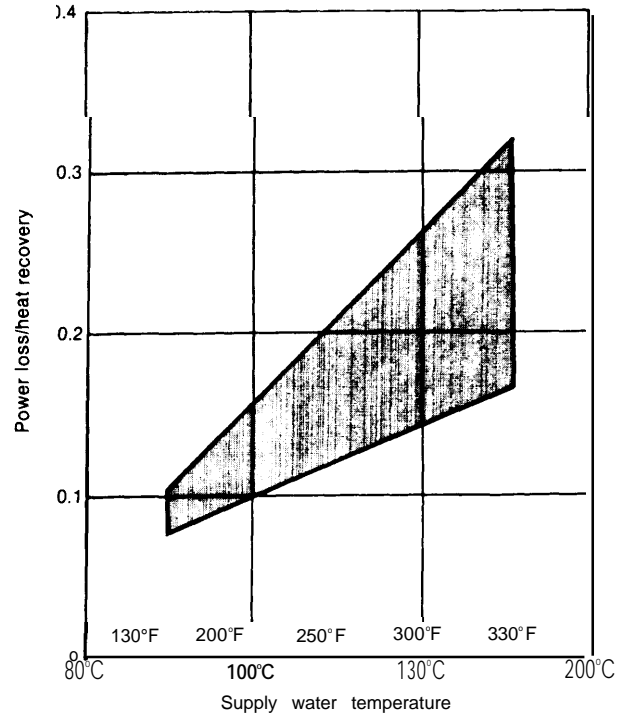

SOURCE: O. Seppanen, and W. Aho, "Building Systems and District Heating," Ekono, Inc., Bellevue, Wash., presented at the Integrated Energy Systems Task Group Technical Review Meeting, Mar 10, 1981, organized by the National Bureau of Standards, Washington, D C

Thus for cities and regions in which replacement of lost generating capacity would be a significant cost, designing a district heat system for relatively low-temperature hot water will help reduce that cost to a minimum. Low-temperature hot water may be somewhat more expensive to transmit and distribute than high-temperature hot water, so these costs must be weighed against the savings in electricity capacity.

**Transmission and Distribution Cost.** Since transmission and distribution costs are always the major part of the costs of district heating, the careful design of district heating to minimize the costs of transmission and distribution will have a major impact on reducing the overall costs of the district heating. Figure 49 shows a typical proposed layout of transmission lines for a hot water district heating system for the city of Detroit. It includes several long feeder lines from outside the proposed heat demand zones and

**Figure 49.—Thermal Demand Zones and Transmission Supply Lines for the Study City of Detroit, Mich.**

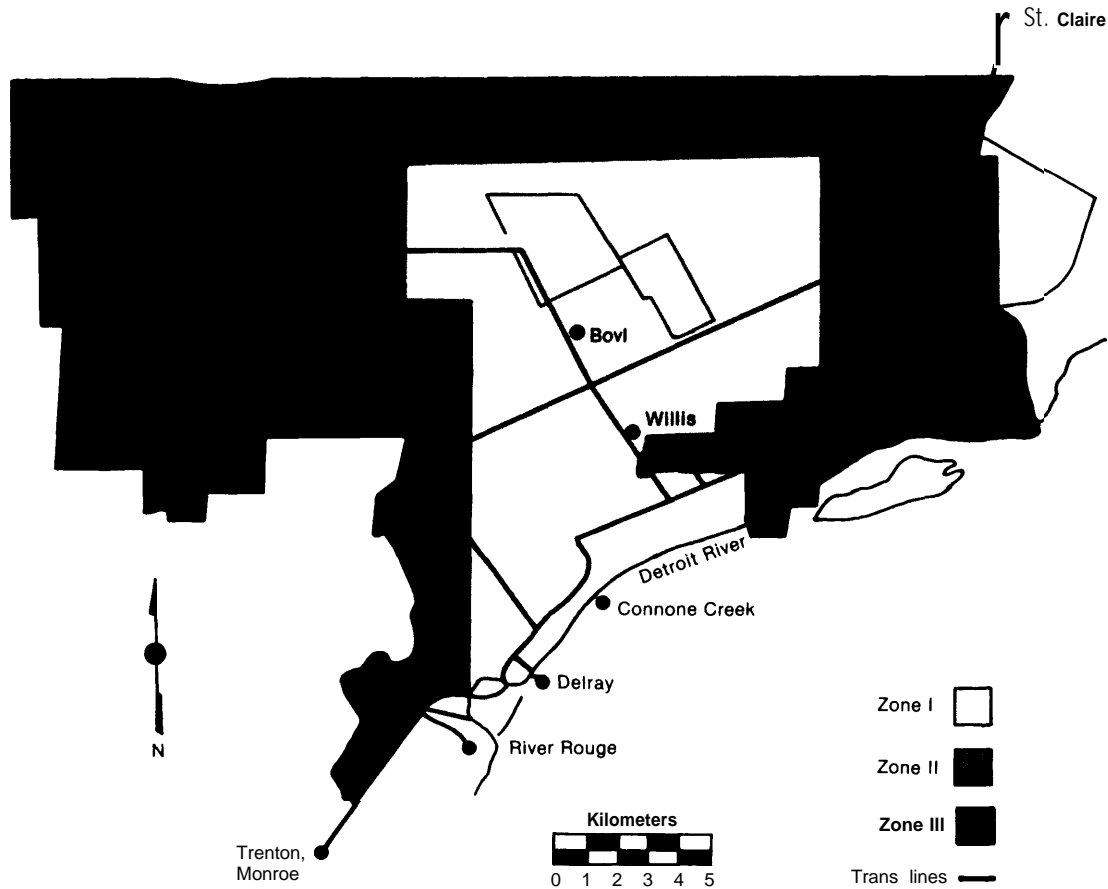

SOURCE: D. J. Santini, A. A. Davis, and S. M. Marder, "Economic and Technical Analysis of Retrofit to Cogenerating District Energy Systems. North Central Cities," Argonne National Laboratory, Argonne, Ill., ANL/CNSV-TM-II, June 1979.

several loops within the demand zone—in all over 100 km of transmission pipes. Prices for transmission pipes (as estimated in the feasibility study for St. Paul) range from several hundred dollars per foot for a 10-inch pipe to several thousand for a 60-inch pipe.<sup>9</sup> Transmission lines alone are estimated to cost between \$456 million and \$859 million for the Detroit system (or between \$1,300 and \$2,600 per foot).

Because of the high costs of transmission lines it is much easier to have a viable district heating system if the heat source is located close to the heat users. At \$2,000 per foot, running a 60-inch pipe an extra 15 miles to a powerplant heat source will cost an extra \$158 million. For hot

water systems there is also some loss of heat from long transmission lines although far less than for long-distance transmission of steam.

**The costs of a district heating distribution system** are minimized if the number and length of distribution pipes can be minimized. Minimum costs occur for a small number of customers located close together, each using large amounts of heat. None of the existing steam systems shown in table 55 has more than **3,500** customers. Most have less than 1,000 customers. Con Ed's customers average 5.1 million Btu per hour, a peak demand for steam (equivalent to **5 million to 10,000 million Btu** heat demand for a heat season, characteristic of a building of **100,000 to 200,000 ft<sup>2</sup>**).

<sup>9</sup>Margen, et al., op. cit. in source for fig. 50.

As customers get smaller and more spread out, the “heat density” of the area to be served by district heating is said to diminish, and this sharply increases the cost of the distribution system. In heat densities typical of high-rise central business districts the total unamortized capital cost of a distribution system may vary from less than a \$1 per annual million Btu delivered for big customers to about \$7 for small customers. In areas whose heat density is more characteristic of duplex or row housing, the unamortized capital cost of distribution to small customers may go as high as **\$30 per annual delivered million Btu**. (See fig. 50 which shows an analysis of distribution system costs typical of Stockholm, Sweden, which was used as part of the feasibility study for the St. Paul district heating system. )

The temperature of the hot water being distributed also affects the cost of distribution. At temperatures below 250° F, the steel pipes carrying the hot water can be insulated with polyurethane foam insulation inside an outer plastic polyethylene casing. These are far cheaper than the steel pipes encased in an outer steel casing that must be used for higher temperature hot water or steam distribution.

**Building Retrofit Costs.** The cost of retrofitting buildings to use district heat is a substantial cost for district heating systems being installed in older cities, such as St. Paul, where buildings already have heating systems, either distribution systems for steam district heat or self-contained boilers or furnaces using natural gas, fuel oil, or

**Figure 50.—Relationship of Average Heat Density and Customer Size to Costs of District Heat Distribution (as estimated for Stockholm, Sweden)**

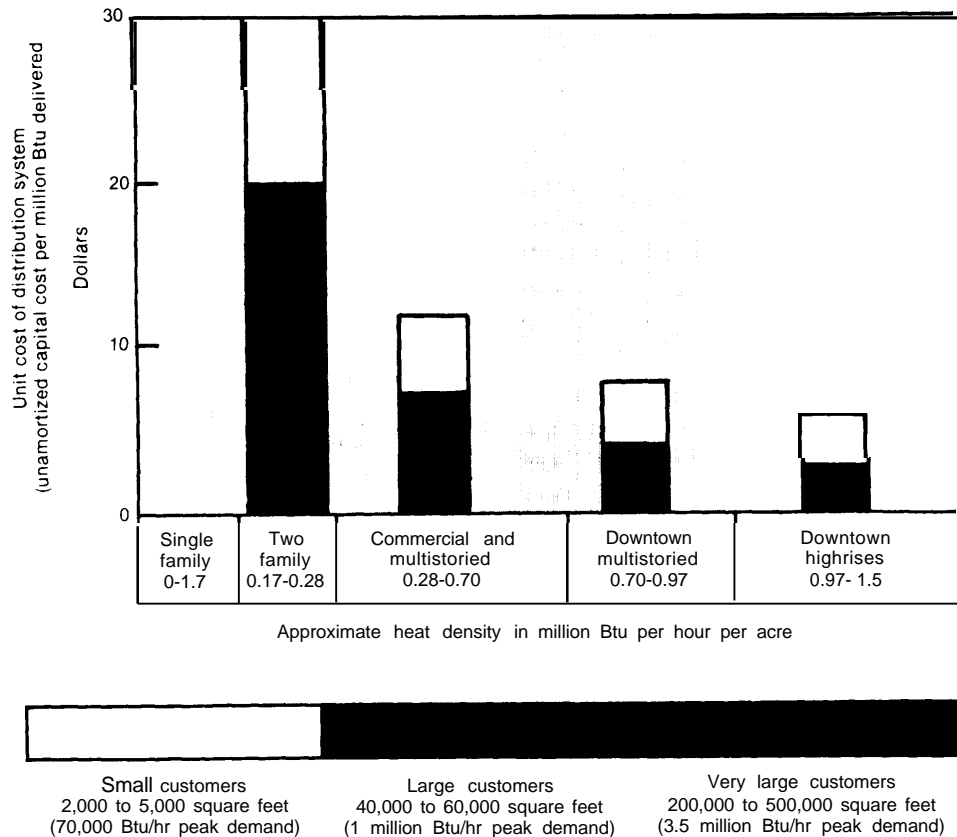

SOURCE: PMargen, et al, "District Heating/Cogeneration Application Studies for the Minneapolis-St Paul Area—Overall Feasibility and Economic Viability for a District Heating/New Cogeneration System in Minneapolis—St Paul," Oak Ridge National Laboratory, Oak Ridge, Tenn., ORNL/TM-6830/P3, October 1979, p 61, and Office of Technology Assessment.

electricity. The cost of retrofit is usually borne by the building owners, but may be borne in part by the district heating system as a marketing device. District heating systems may also have to assist with financing retrofit. The easiest buildings systems to convert to district hot water are obviously those which already use hot water. The hot water boiler is then replaced by a heat exchanger that uses the district hot water for a heat source. Buildings that use steam are probably next most easy to convert because the steam radiators can often be converted to hot water. The steam distribution system, however, must usually be replaced with a larger two-pipe piping system to accommodate hot water rather than steam. Alternatively, high-pressure district hot water can be converted to steam inside a building for use in the building's steam radiators. Cities with existing steam district heating systems have large numbers of buildings equipped to use district steam heat.

Buildings with oil or gas furnaces and air distribution systems can sometimes provide heat to the air by wrapping hot water pipes around the ducts or furnace. If this does not prove possible then a more expensive step is necessary—installing hot water baseboard radiation. Those buildings whose systems adapt only at great expense to district heating are those buildings with “complex” systems (described in ch. 3) where air systems have individual electric coils to reheat the air in zones where heat is needed.

All other things being equal, the costs of building retrofit (as for distribution systems) are least per delivered million Btu for large heat users and most for small heat users. The St. Paul feasibility study also examined these costs. The costs to convert a steam system to district heating for a moderate size building averaging 1.7 million Btu per hour of heat demand (or about 4,500 million Btu a season) would be about \$9 unamortized capital cost per annual million Btu. Once a building demands 10 times that amount of heat, the costs of retrofit fall sharply—to less than \$3 unamortized cost per annual million Btu (see fig. 51).

At \$9 per annual million Btu a retrofit that allowed a building owner to save \$1 per million

Btu on his heating costs by using district heat instead of fuel, would take 9 years to pay back cost. For many building owners these retrofits would cost \$0.50 to \$1 per ft<sup>2</sup>, well above the accepted threshold below which capital expenditures can be easily financed (see the discussion of building owner decisions in ch. 4).

The capital costs of building retrofit are, for these reasons, a component of district heating that is difficult to handle since they are a potential obstacle to customer hookup. There are arguments for at least sharing them between customers and system and perhaps for the system assuming the whole cost. The more small buildings or difficult-to-retrofit buildings there are in a potential district heating zone the more difficult it may be to share or absorb these costs and this may pose a major obstacle to the success of district heating.

**District Heat for New Buildings.** In contrast to existing buildings, hookup to a district heating system offers substantial economic benefits to owners of new buildings who may save up to **\$250,000** on the cost of a self-contained heating system. Eliminating a self-contained heating system **also frees** up significant rentable space in the building and saves on labor and maintenance costs. Thus, district heating systems may have the best chance of obtaining long-term contracts with significant numbers of customers if they are able to start with new buildings in a downtown redevelopment area or rapidly growing area around a new subway system or suburban transportation crossroads.

**The Impact of Different Financing Assumptions.** The annual capital costs of some of the district heating systems listed in table 58 will vary greatly according to what assumption is made about the capital recovery factor. Table 59 shows the estimated costs for two of the cities with capital recovery factors of 0.10, 0.15 and 0.20. A capital recovery factor of 0.10 is approximately equivalent to paying 8-percent interest on a 20-year loan while a capital recovery factor of 0.20 is equivalent to an interest rate of almost 20 percent for a loan of the same term.

Figure 51.—Building Retrofit Costs as Building Size Increases

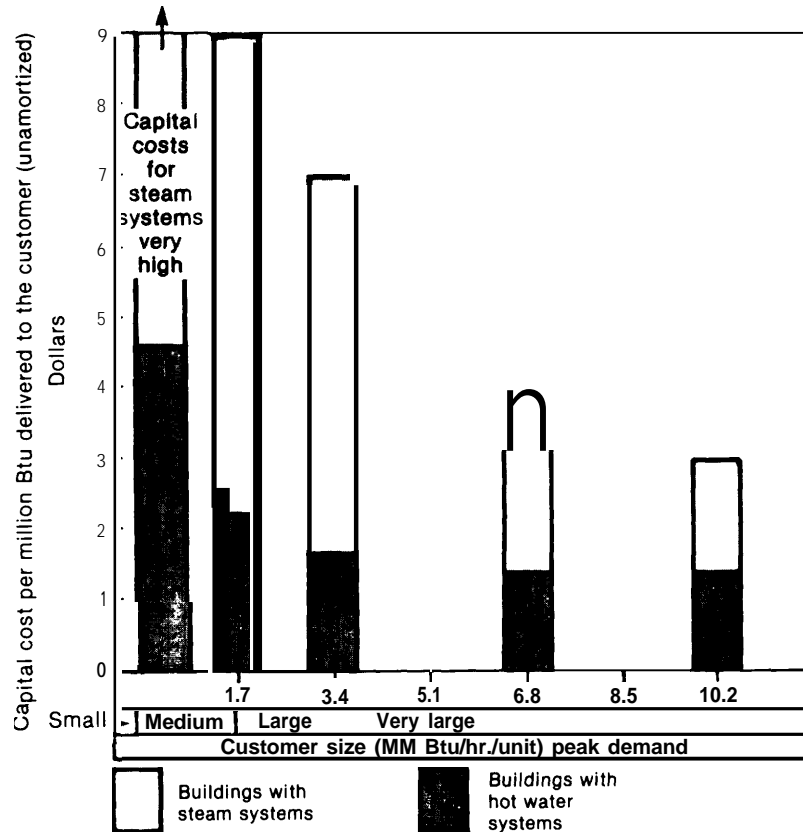

SOURCES: P Margen, et al., "District Heating/Cogeneration Application Studies for the Minneapolis-St. Paul Area—Overall Feasibility and Economic Viability for a District Heating/New Cogeneration System in Minneapolis-St Paul," Oak Ridge National Laboratory, Oak Ridge, Tenn., ORNL/TM-6830/P3, October 1979, p 65; and the Office of Technology Assessment.

Table 59.—Annualized Capital Costs for Proposed District Heating Systems Under Alternative Capital Recovery Factors (in dollars)

| Proposed systems (one zone with highest thermal load) | Annual capital cost per million Btu  |           |
|---|--------------------------------------|-----------|
|   | Cleveland                            | Milwaukee |
|   | High estimate of costs (unamortized) | (\$69.28) |
| Capital recovery factor of:                           |                                      |           |
| 0.10  | 6.93                                 | 7.67      |
| 0.15  | 10.40                                | 11.51     |
| 0.20  | 13.86                                | 15.34     |
| Low estimate of costs (unamortized)                   | (29.70)                              | (36.33)   |
| Annual capital recovery factor of:                    |                                      |           |
| 0.10  | 2.97                                 | 3.63      |
| 0.15  | 4.46                                 | 5.45      |
| 0.20  | \$ 5.94                              | \$ 7.26   |

SOURCE: Office of Technology Assessment using data from Santini, et al., "Economic and Technical Analysis of Retrofit to Cogenerating District Energy Systems. North Central Cities," Argonne National Lab. June 1979.

The annual capital costs of a district heating system with a capital recovery factor of 0.20 will be double those of a system with a recovery factor of 0.10. Since capital costs are such a large fraction of total costs the interest rate will make the major difference in whether the district heating prices are competitive with alternative sources of heat.



## VARIATIONS IN DISTRICT HEATING SYSTEMS

All district heating systems have in common the major capital expense of transmission and distribution systems. Some variation in capital costs is possible, however, by varying the sources of heat. District piping systems can also be varied by using them to carry cool or luke-warm water for heat pumps.

Sources of heat other than waste heat that can be used for district heating systems include: direct coal combustion without cogeneration, cogeneration using oil or natural gas, municipal solid waste, and solar and geothermal energy. Less is known about the costs of some of these and most of these methods would only be possible in certain cities in the United States. Each is described briefly below.

Direct coal combustion, without cogeneration, takes advantage of the lower fuel cost of coal and the economies of scale in handling coal and processing it centrally. The capital cost is comparable to the capital cost of retrofitting an existing powerplant for district heating plus replacing lost generating capacity, but far more than the cost of retrofitting the powerplant alone (see table 60).

Direct coal combustion without cogeneration may make sense in cases where sources of waste heat could be made available only if the lost electric capacity were replaced. In many cities there are environmental restrictions prohibiting on new sources of coal combustion;

**Table 60.—Comparison of Capital Costs for a Heat-Only Coal Boiler and Recovery of Waste Heat From Electricity Generation**

|  | Total capital cost per delivered million Btu | Capital cost per million Btu at a capital recovery factor of 0.15 |
|--|--|---|
| Fluidized bed coal burning low pressure boiler ? . . . . | \$15.85                                      | \$2.38  |
| <i>Detroit system?</i> <sup>2</sup>                      |  |   |
| Powerplant retrofit . . . . .                            | 2.25- 4.48                                   | .33- .61  |
| Replace lost generating capacity . . . . .               | 8.89-11.19                                   | 1.33-1.67   |
| Total . . . . .  | 11.14-15.61                                  | 1.66-2.28   |

SOURCES: Pferdehirt and Kron, op. cit., Davy McKee Corp., "Cost Comparison Study, Industrial Size Boilers; 10,000 to 400,000 Pounds per Hour," October 1979.

these would have to be waived for a new coal boiler for district heating.

The operating and maintenance costs will be substantially higher for a heat-only coal boiler than they will be for a retrofit powerplant. This is because all the operating cost and fuel cost of the heat-only boiler must be charged to the district heating system while the fuel costs and operating cost of a cogenerating powerplant are *shared* between district heating and electricity generation.

### Cogeneration Using Fuel Oil or Natural Gas.

For small-scale district heating systems such as the Trenton system (described in box L) or the Harvard Medical Area System (described in box M) it may make sense to provide district heat using oil or natural gas fired diesel cogenerators, or other small-scale cogenerators. The many varieties of these cogenerators and the economic and regulatory problems affecting their use will be the subject of an entire forthcoming OTA report "industrial and Commercial Cogeneration." The cost of the more expensive fuel can be recovered in part from sales of electricity to one or more utilities. Such a small-scale system can serve as the core of a larger district heating system that can expand over time to the point where it makes economic sense to use coal directly, or after converted to a gas.

**Municipal Solid Waste. Municipal solid waste may be an excellent source of heat for district heating especially** in densely populated urban areas where landfill costs for disposal of solid waste are high. It is not easy to retrofit existing incinerators for heat recovery, however. Efficient production of heat from solid waste almost always requires new construction or extensive rebuilding.<sup>10</sup>

Furthermore, few cities have enough solid waste to produce heat in any large quantities. Only 23 cities and 72 standard metropolitan sta-

<sup>10</sup>For more information on energy from solid waste see Office of Technology Assessment, U.S. Congress, *Materials and Energy From Municipal Waste*, OTA-M-93 (Washington, D. C.: U.S. Government Printing Office, July 1 979).

tistical areas produce more than 1,000 tons per day of municipal solid waste (see tables 61 and 62). Given some standard assumptions about the heat content of solid waste and the efficiency of heat recovery, 1,000 tons per day would produce about 700,000 million Btu over a heating season of 100 days. This is equivalent to less than 5 percent of the heat production of the first proposed citywide St. Paul district heating system.<sup>11</sup>

The costs of heat from solid waste are sufficiently high that they must be offset by charging tipping fees to those unloading the solid waste if

<sup>11</sup> The heat output (in millions of Btu) from 1,000 tons per day of waste was calculated by assuming a heat production of 5,000 Btu per pound of solid waste combusted at 68 percent efficiency for a total of 6.8 million Btu per ton. Multiplied by 100 days at 1,000 tons per day gives 680,000 million Btu over a heating season. Sources for the calculation: Off Ice of Technology Assessment, op. cit.; and Pterdehirt, op. cit. (source for figs. 1 and 2).

**Table 61.—U.S. City Size, Population and Waste Production in 1975**

| City size range (thousands) | Number of cities | Population (million) | Average population per city (thousands) | Average municipal solid waste per city (tons/day) |
|-----------------------------|------------------|----------------------|---|---|
| 5-10                        | 1,463            | 10.3                 | 7.1                                     | 12  |
| 10-20                       | 977              | 13.8                 | 14.1                                    | 25  |
| 20-25                       | 238              | 5.3                  | 22.0                                    | 39  |
| 25-50                       | 514              | 17.9                 | 34.9                                    | 61  |
| 50-100                      | 230              | 16.1                 | 70.0                                    | 122   |
| 100-250                     | 105              | 14.9                 | 142.0                                   | 248   |
| 250-500                     | 34               | 11.8                 | 348.0                                   | 609   |
| 500-1,000                   | 17               | 11.3                 | 664.0                                   | 1,160   |
| Over 1,000                  | 6                | 17.8                 | 2,970.0                                 | 5,200   |

SOURCE. Off Ice of Technology Assessment, U.S. Congress, *Materials and Energy From Municipal Waste*, OTA-M-93 (Washington, D. C. U.S. Government Printing Office, July 1979)

**Table 62.—U.S. Standard Metropolitan Statistical Areas (SMSAs) Size, Population, and Waste Production in 1975**

| SMSA size (thousands) | Number of SMSAs | Population (million) | Average population per SMSA (thousands) | Average municipal solid waste per SMSA (tons/day) |
|-----------------------|-----------------|----------------------|---|---|
| Under 100             | 27              | 2.5                  | 92                                      | 160   |
| 100-250               | 97              | 16.6                 | 171                                     | 300   |
| 250-500               | 63              | 22.7                 | 361                                     | 630   |
| 500-1,000             | 37              | 27.1                 | 733                                     | 1,280   |
| 1,000-2,000           | 20              | 28.3                 | 1,417                                   | 2,480   |
| 2,000-3,000           | 8               | 19.0                 | 2,373                                   | 4,150   |
| Over 3,000            | 7               | 40.0                 | 5,693                                   | 9,960   |

SOURCE. Office of Technology Assessment, U.S. Congress, *Materials and Energy From Municipal Waste*, OTA-M-93 @Washington, D. C." U.S. Government Printing Office, July 1979)

the heat is to be competitively priced. The annualized cost of steam per million Btu from waterwall incineration, for example (including operating and maintenance costs), has been estimated at about \$3.80 per million Btu.<sup>12</sup> A tipping fee of \$10 per ton would reduce the cost of heat by about \$1.50 per million Btu, to a total of **\$2.30 per million Btu** for the cost of heat alone without transmission or distribution costs.

A tipping fee of \$10 per ton would be equivalent to the high end of the estimated current range of tipping fees of \$2 to \$10 per ton at urban landfills throughout the country.<sup>13</sup> In the future, however, in congested areas, landfill costs are expected to increase. Thus, heat from solid waste for district heating should be an economically viable but modest contributor to district heating systems.

**Solar Energy. In principle**, solar energy would be used to supply heat for district heating. In practice, the capital cost of such heat is far above the cost of alternative sources of heat.

The cheapest and simplest source of solar heat to a district heating system is a solar pond. This is a shallow body of water with a dense salt-water solution on the bottom and increasingly less salty, and lighter layers above it. The bottom of the pond is blackened and heat is absorbed in the heavy salty layers up to temperatures of 150° to 200° F and is prevented from being dissipated by the lighter layers of water. The hot salty water at the bottom of the pond can then be used to heat water for district heating by passing through a heat exchanger.

A detailed analysis of the costs of a 400-acre solar pond for district heat was done for Northampton, Mass.<sup>14</sup> (see table 63). Without including the land cost for the pond, the cost of constructing it was estimated at \$88 million for an

<sup>12</sup>Office of Technology Assessment, op. cit., p. 124. Assumes a cost of \$25.60 per ton and 6.8 million Btu per ton.

<sup>13</sup>"Resource Recovery Activities," reprinted from *NCRR Bulletin*, National Center for Resource Recovery, Inc., vol. 10, No. 3, September 1980; and "Small Power Production and Cogeneration Facilities—Qualifying Status/Rates and Exemptions—Appendixes to draft Environmental Impact Statement," SRI International, Menlo Park, California for the Federal Energy Regulatory Commission, Washington, D. C., FE RC/EIS 001 9/D, June 1980.

<sup>14</sup>A. s. Kras and R. LaViale, 111, "Community Solar Ponds," *Environment*, vol. 22, No. 6, pp. 25-33, July/August 1980.

**Table 63.—Costs of Solar Heat Compared to Heat-Only Coal Boiler for District Heating**

|  | Capital cost/delivered million Btu (in dollars) |                        |
|--|---|------------------------|
|  | Unamortized                                     | Amortized at 0.15/year |
| <b>Heat source only:</b>                   |   |                        |
| Heat only coal boiler (estimate). . . . .  | \$ 15.85  | \$ 2.38                |
| Northampton solar pond (estimate). . . . . | 103.30  | 15.50                  |
| <b>Total system:</b>                       |   |                        |
| Northampton solar pond . . . . .           | 148.52  | 22.30                  |
| Lyckebo Sweden system . . . . .            | \$623.00  | \$93.45                |

SOURCES: Coal boiler cost estimates from table 60 above; solar pond estimates from A. S. Krass and R. La Viape III, "Community Solar Ponds," *Environment* volume 22, no. 6, pp. 25-33, July/August 1980; costs for Lyckebo system from J. Gleason, "Efficient Fossil and Solar District Heating Systems: Preliminary Report" to the Solar Energy Research Institute and the New England Sustainable Energy Project, 1980.

unamortized cost of about \$103.30 per delivered million Btu for the source of heat alone. This is a cost far greater, for example, than the cost of heat-only coal-burning described above. At a capital recovery rate of 0.15, heat from the solar pond would cost about \$15 per delivered million Btu while heat from the coal boiler would cost about \$2.40 per delivered million Btu.

Solar heat from two completed projects in Sweden, Lyckebo and Inglestad, is even more expensive. The total cost of the district heat is about \$625 per delivered million Btu in unamortized capital costs and about \$94 per million Btu if amortized at 0.15 per year.<sup>15</sup>

Geothermal. Heat from the Earth or geothermal energy is a fine source of heat for district heating for the few potential district heating systems located near a geothermal field. Boise, Idaho, established a district heating system from geothermal hot water in 1890. **A recent estimate of the cost of expanding the system calculates that the annualized cost of the hot water from the enlarged system would be only \$2.30** per million Btu.<sup>16</sup> Two recent systems have been built from scratch, in Midland, S. Dak. and Mammoth Lakes, Calif., with unamortized capital costs of \$39 to \$44 per annual delivered

million Btu. These systems thus have capital costs quite comparable to the first phase of the proposed St. Paul district heating system.<sup>17</sup>

Few large cities are located near geothermal fields. In addition, there are several other problems with geothermal systems. The most obvious is that it may be difficult to locate a geothermal field and estimate its size. In Iceland and New Zealand where geothermal heat is used frequently, the average lifetime of geothermal well is no more than 20 to 30 years.<sup>18</sup> Hot geothermal brine is corrosive and difficult to transport. Improvements are needed in many aspects of a geothermal technology, such as well drilling and pipeline construction, in order to bring costs down.

**Other Variations on District Heating: District Cooling and Water for Heat Pumps. There are three other, more comprehensive, variations on the basic district heating system that may have considerable promise** for the future, although little effort has been made to date to estimate their costs. District cooling may prove an attractive supplement to district heating in the South and *district water for heat pumps* may also be economically viable in the North as well as the South.

**District Cooling. High-temperature pressurized hot water or steam can be used for** cooling by building owners with absorption air-conditioners. Many buildings in such cities as Baltimore and New York use steam from the existing steam system to run absorptive air-conditioners. The new hot water district heating systems under consideration, however, could only provide heat for absorption air-conditioners if the temperature is greater than 250° F.

Central chillers, using electricity or heat (if they are absorption air-conditioners), can also provide chilled water to a district heating system. In this case the transmission and distribution systems cost would be greater than for the

<sup>15</sup>N.L. Book, et al., "Economics of Low Temperature, Direct Use Applications of Geothermal Energy," *Energy*, vol. 6, pp. 317-322, April 1981.

<sup>16</sup>T.M. Goldman and B. D. Rosenthal, "Modeling the Interactions Between Geothermal Energy Use and Urban Structure," *Energy*, vol. 6, pp. 351-368, April 1981.

<sup>15</sup>P. Margen, "Economics of Solar District Heating," *Sunworld*, vol. 4, No. 4, pp. 128-134, 1980.

<sup>16</sup>T.M. Goldman and B. D. Rosenthal, "Modeling the Interactions Between Geothermal Energy Use and Urban Structure," *Energy*, vol. 6, pp. 351-368, April 1981.

hot water only system described above since four pipes would have to be laid, two for chilled water and two for hot water. Maintenance and materials cost, however, is lower for pipes carrying chilled water and Btu losses could also be lower. In new communities, where piping system costs can be minimized and the district heating and cooling can substitute for conventional heating systems and air-conditioners, district heating and cooling may make economic sense.<sup>19</sup>

**District Water Systems With Heat Pumps.** Heat pumps can make effective use of lukewarm or cool water that is being returned to a heat source such as a cogenerating powerplant. When a system is well designed the temperature of return water can be as low as 50° to 80° F, too low to heat a building but high enough to allow a heat pump to function at high efficiency (coefficients of performance of 2.5 or better) even when air temperatures are very low. Such a system, combining district heat with water suitable for increasing the efficiency of heat pumps is under development in Easton, Md., sponsored by the municipal utility there. In principle a district piping system could also be used to make low-temperature geothermal sources or ground water available for use during the winter months to enhance the efficiency of heat pumps.

For all such systems, the high capital cost of piping must be compared to the extra efficiency of a central chiller or higher efficiency operations of heat pumps. Under some conditions the value of the latter may outweigh the piping system cost.

<sup>19</sup>A wide variety of district heating and cooling systems are analyzed in *Application of Solar Energy to Today's Energy Needs*, vol. II, Office of Technology Assessment, OTA-E-77 (Washington, D. C.: U.S. Government Printing Office, June 1978).

**Retrofit of Existing Steam Systems To Use Hot Water.** The prime locations for hot water district heating in many major American cities—Boston, New York, Baltimore, St. Paul, Minneapolis, Chicago, and Detroit among others—are already occupied by existing or recently closed down steam systems. In principle, some of the maintenance costs and thermal losses associated with steam systems might be avoided if the steam systems were converted to pressurized hot water.

In practice such conversion of existing systems from steam to hot water would be costly and difficult. Hot water pipes must be larger than steam pipes for the same Btu volume. Furthermore, an extra set of pipes would have to be laid to carry the return flow of cool water. (Steam systems either dump the condensed steam or have it return along the bottom of the outgoing pipe.)

The buildings hooked up to the steam district heating system would have to be retrofitted to use hot water. Absorption air-conditioners using district steam (very common in cities such as Baltimore) would only continue to function if the new district heating system used high-temperature pressurized hot water.

Because of the difficulty of retrofitting them, the large number of existing and recently defunct steam district heating systems is a major obstacle to the rapid penetration of hot water systems in U.S. cities. New hot water district heating systems in these cities may have to incorporate plans to purchase these old systems (as the St. Paul system did in the summer of 1981) and try to convert their customers to hot water. Heat sources for the old systems, as in the St. Paul case, can be used as backup for the new systems.

## NONCAPITAL COSTS OF DISTRICT HEATING

Most of the cost of district heating is the annualized cost of capital. There are, however, two other kinds of costs:

- . operating and maintenance cost of the distribution system, and

- . operations and maintenance cost and fuel cost of whatever heat source is used.

**Distribution System Operations and Maintenance (O&M).** The cost of operating and maintaining a steam system can be very high espe-

cially as it gets old because the pipes corrode over time and the steam traps (V-shaped depressions where the steam condensate drips out) get clogged and must be cleared by access through a manhole. In principle hot water systems are easier to maintain. There are no steam traps and plastic pipes used in the distribution systems do not corrode. In a district heating planning guide, Argonne Laboratory estimates the cost of operating a hot water transmission and distribution system at 1 percent of the initial capital cost of those systems, based on experience in Denmark and Sweden. Depending on the capital cost of the transmission and distribution systems, the O&M cost would vary from \$0.18 to \$0.46 per million Btu delivered for the Washington system.

The O&M and fuel cost of the heat source will vary with the extent to which the cost of heat is shared with electricity generation. All of the cost of a heat-only coal boiler will be borne by the district heating system while only a share of the cost of the cogenerating electricity plant will be charged to district heating. For one plant analyzed in the Argonne Planning Guide the plant O&M and fuel costs were estimated to be eight times the O&M for the distribution lines.<sup>20</sup> Thus fuel and O&M for the waste heat from the powerplant are likely to run between \$1.50 and \$4 per million Btu and total fuel and O&M costs would then range from \$1.70 to \$4.50 per delivered million Btu of heat.

<sup>20</sup>Pferdehirt, *op. cit.*, p. 40

## COMPETITIVE PRICING OF DISTRICT HEATING SYSTEMS AND THE BUILDING OWNER'S POINT OF VIEW

The best district heating system in the world will not be a success if buildings do not hook up to it. Whether they do or do not will depend, first of all, on whether the price of the district heat is competitive with the existing sources of heat to the building. Beyond price there are further considerations which may hinder building hookups even if the price is competitive. The building owner may have to pay for his own retrofits. If so, the cost of district heat will be lower but the building owner will have to finance or come up with the cash for a retrofit which is estimated to cost from under \$0.70 to over \$2.70 per square foot.<sup>21</sup> Even if the building owner does not have to pay for his own retrofit, he may be reluctant to risk a change to a new heating and/or cooling system without clear guarantee that he will be saved expense.

How competitive district heating prices will be to a particular building owner depends on three factors:

- The price of the district heat.
- The current price of the fuel or electricity used to heat (or cool) the building and the expected increases in those prices.
- The efficiency with which that fuel is used compared to the efficiency of the potential district heat.

The latter two factors combined will give the owner a theoretical break-even price, below which district heat will cost less than his current source of heat.

As seen above, the cost of district heat itself is primarily determined by the annual cost of capital used to construct the system. In a situation in which the price of district heat must be low to compete with the building owner's current source of heat, it may be possible to obtain less expensive financing to keep the district heat prices low enough.

Using the capital costs estimated by Argonne for a possible district heating system in Milwaukee, OTA analyzed what the financing rate (expressed as an annual capital recovery factor) would have to be for the district heat to be competitive with different kinds of fuel used at different levels of efficiency. The results are shown

<sup>21</sup>D. T. Santi ni and S. S. Bernow, *Feasibility of District Heating and Cooling in Core Areas of Major Northern U.S. Cities by Cogeneration From Central Station Powerplants*, presented at the Northeast Regional Science Association Meetings, Amherst, Mass., May 18-20, 1979.

in table 64. In the best situation, if the district heat is competing with No. 2 distillate heating oil and the district heating system is constructed with the low estimate of costs, the system could be privately financed at an annual capital recovery factor of 0.15 to 0.19 and still be priced lower than the competition.

In the worst situation, on the other hand, if the system costs as much as the high cost estimate and if it is competing with No. 6 residual heating oil or natural gas used at the same efficiency (80 percent) as the district heat, then the district heat would only be competitive if it were financed at the miniscule capital recovery rate of 3 percent per year.

**The Impact of Price Escalation in Competing Fuels.** It is widely believed that natural gas and heating oil will increase in price faster than inflation and that this increase will make district heating competitive in several years against fuels with which it is not now competitive. The critical question, however, is not whether fuels will increase faster than inflation in general but whether they will increase faster than the construction cost for building a district heating system. Over the decade from 1970 to 1980, for example, construction costs increased somewhat faster than inflation.

OTA estimated (in table 65) how many years it would take before a proposed district heating system (for the city of Milwaukee) would be competitive with distillate and with residual

**Table 65.—Impact of Fuel Escalation Assumptions on the Break-Even Point in a Proposed District Heating System for Milwaukee**

|   | If fuel cost escalates (at an annual rate) faster than the capital costs of district heating |          |         |
|---|--|----------|---------|
|   | 2%   | 50/0     | 10%     |
| <i>/n how many years would there be a breakeven point</i> |  |          |         |
| <i>Building uses No. 2 at 0.65 efficiency</i>             |  |          |         |
| Low cost @ 0.15 CRF <sup>a</sup> . . . . .                | — Immediate breakeven —  |          |         |
| High cost @ 0.15 CRF . . . . .                            | 20 years   | 8 years  | 4 years |
| High cost @ 0.10 CRF . . . . .                            | 4 years  | 2 years  | 1 year  |
| <i>Building uses No. 6 at 0.65 efficiency</i>             |  |          |         |
| Low cost system @ 0.15 CRF . . . . .                      | 15 years   | 6 years  | 3 years |
| High cost system @ 0.15CRF . . . . .                      | 45 years   | 18 years | 9 years |
| High cost @ 0.10 CRF . . . . .                            | 28 years   | 11 years | 6 years |

<sup>a</sup>CRF = Capital recovery factor equals fixed annual rate in which capital investment is amortized.

SOURCE: Office of Technology Assessment using data from Santini, et al., op. cit., table 5.

**Table 64.—Subsidized Financing Would Be Required in Some Cases for District Heating To Be Competitive With Fuel Oil**

|  | Energy price <sup>a</sup> | Breakeven district heating price <sup>b</sup> | Capital recovery factor required for breakeven price Milwaukee system <sup>c</sup> |          |
|--|---------------------------|---|--|----------|
|  |                           |   | High cost  | Low cost |
|  | Dollars/million Btu       |   |  |          |
| <i>Building 1: Burns No. 2 (distillate) heating oil at 0.65 efficiency . . . . .</i> | \$7.50                    | \$8.95  | 0.09   | 0.19     |
| <i>Building 2: Burns No. 2 (distillate) heating oil at 0.80 efficiency . . . . .</i> | 7.50                      | 7.50  | 0.07   | 0.15     |
| <i>Building 3: Burns No. 6 (residual) heating oil at 0.65 efficiency . . . . .</i>   | 4.50                      | 5.54  | 0.05   | 0.10     |
| <i>Building 4: Burns No. 6 (residual) heating oil at 0.80 efficiency . . . . .</i>   | \$4.50                    | \$4.50  | 0.03   | 0.07     |

<sup>a</sup>This corresponds to late 1980 prices of \$1.04 per gallon for distillate (No 2) fuel oil and \$2800 per barrel residual (No 6) fuel oil as reported in the Department of Energy Monthly Energy Review.

<sup>b</sup>Assumes that district heat is used with 80 percent efficiency in the building.

<sup>c</sup>Capital recovery factor equals fixed annual rate in which capital investment is amortized (principal plus interest)

SOURCE: Office of Technology Assessment using data from Santini, et al., op. cit., "North Central Cities."

heating oil (assuming lower efficiency use of fuel than district heat). The low cost district heating system would break even immediately against distillate if conventionally financed. The high cost system on the other hand would not break even for 4 years (at conventional financing) even if distillate were to escalate in price each year 10 percent faster than the construction costs of district heat. When competing against residual fuel oil even the low cost system would not break even under conventional finance for 3 years at the high fuel escalation rates.

**District Heating as a Hedge for Building Owners Against Future Rapid Energy Price Increases.** In principle, district heating could be a good hedge against future price hikes. The debt service for a single phase of a district heating system, constructed all at once and not expanded, will not increase at all from year to year and over time will decrease in constant dollars. The only part of the price of the district heating price to escalate will be the fuel and O&M cost.

Most district heating systems, analyzed by Argonne, however, would be constructed in

phases. The St. Paul-Minneapolis system is expected to take 20 years to construct. As each new phase is added to the system the debt service to cover the higher construction cost of that phase will be averaged in with the less expensive debt service of earlier phases and the average price of district heat for all customers is likely to rise. Thus, for each individual building owner the price relationships expressed in table 65 are likely to govern his expectations about break-even points. If his current fuel costs less than the price of district heating it is not likely to escalate much faster than 10 percent faster than district heating, and all the rest of table 65 applies in calculating the number of years before break even.

To sum up, district heating systems under current cost estimates can only compete, if they are to be conventionally financed, with building owners using the highest cost fuel. Competing against building owners using natural gas or residual oil requires substantial financing subsidy, especially if the actual costs of the system are at the high end of the estimate.

## CONTINGENCIES IN PLANNING A DISTRICT HEATING SYSTEM

planning and carrying out a project of the scale of district heating is inevitably risky since fairly narrow conditions must be met for theoretical economic success. There is a long list of things which may go wrong:

- The costs may be much greater than anticipated. A Rand study of cost overruns in major public and private projects calculated that the average cost overrun in eight rapid transit projects and 58 major building projects was over 50 percent. For one-of-a-kind projects, cost overruns were higher—10 percent.<sup>22</sup>
- Fewer customers may sign up than anticipated.

- Customers may demand less heat than anticipated.
- Financing costs may go up in the middle of the project.
- There may be delays in getting environmental and other approvals which prolong debt service and add considerably to financing costs.

All these problems are illustrated by the experience of a private district heating and cooling cogeneration project which was scheduled to become fully operational in 1981. Constructed by Harvard University for five hospitals in Boston and its own medical, dental, and public health schools, it is the largest cogeneration/district heating project—private or public—to be built in the decade of the 1970's. The project described in box M, ran into almost all the problems listed above. Costs, in current dollars,

<sup>22</sup>Edward w. Merrow, Stephen W. Chapel, and Christopher Worthing, "A Review of Cost Estimation in New Technologies: Implications for Energy Process Plants," Rand Corp., July 1979.

### Box M.-Setbacks . . . The Harvard Medical Area Cogenerating and District Heating Plant\*

When the first estimate was made in 1972, it looked expensive (\$50 million) to build a cogenerating plant to supply steam and electricity to five Boston hospitals and the Harvard Schools of Medicine, Dental Medicine and Public Health but it appeared to save substantial energy (\$2 million worth of electricity per year) compared to simply rebuilding the existing steam plant. Now the original estimate looks like a bargain.

Eleven years later, the plant is producing steam and chilled water but all the diesels to cogenerate steam and electricity will not be installed until the summer of 1982. The project has been plagued by construction cost overruns and sharply increased interest rates. Moreover, the installation of the six diesels (which were purchased in 1974 for \$1 million each) has been delayed for more than 3 years because of protracted hearings on environmental impacts. The first round of State review included 186 hours of oral testimony and produced 7,300 pages of transcript and documents. The State review finally approved the diesels in May 1981, but the approval contains 32 specific constraints on the diesel operation.

As of the fall of 1981, the best estimate of the total cost of the project—including construction cost overruns, higher interest rates and extra interest due to delays—is a total of \$230 million, almost five times the original estimate. Reestimates now in progress could bring the total even higher. Several hoped-for financing schemes have been thwarted. The Boston hospitals have been willing to sign 40-year contracts as customers but have not been willing to become partners in the venture. Plans for leverage-lease financing with several different private financing organizations also fell through. Harvard University remains the sole owner of the plant. Negotiations are now underway for tax-exempt revenue bond financing through the Massachusetts Health and Educational Facilities Administration.

There are probably no real morals to this story except that projects should be designed to be resilient to at least some forms of bad luck, if not to all the forms that plagued this project. Furthermore, large projects and first-of-a-kind projects may be even more vulnerable to setbacks than others. Meanwhile the project will begin to provide electricity by the summer of 1982 and within a decade electricity costs may have escalated enough that it will look in retrospect like a central station prudent investment.

\*David Rosen "Background on the Medical Area Total Energy Plant," a paper distributed at the Integrated Energy Systems Task Group technical review meeting Aug. 11, 1981; "How Does It Feel To Have a 73-Megawatt Headache?" *Harvard Magazine*, July-August 1980, pp. 19-20.



were four times the 1972 estimate. Financing costs doubled in the middle of the project and delays for environmental approvals added more than 3 years of debt servicing cost.

There are tricky problems associated with the initial sizing of the system. If the actual demand for heat is overestimated, the transmission and distribution pipes may be larger and cost more than necessary, and this can add significantly to the capital cost of the system. OTA analyzed (for a proposed Washington, D.C. system) how several different contingencies might affect the total annualized capital cost (and therefore price) of district heat. The results are shown in table 66. Compared to the base case, for example, district heating would cost \$0.50 per million Btu more if there were 40 percent conservation after district heating customers signed up. To avoid these shortfalls in customers and demand, financing in many district heating systems is contingent on the signing of 20- or 30-year "take-or-pay" contracts with major customers. In these contracts, the customer agrees

to pay for a certain amount of district heat, whether or not it is used.

**Conservation and District Heating.** Many of the conservation measures described in chapter 3 as suitable for office buildings and multifamily buildings would not be applicable to a building heated with district heat. Some would, however, be equally cost effective. In multifamily buildings domestic hot water improvements such as storage tank insulation and flow restrictors could reduce the hot water demand, and night insulation or storm windows could reduce the space heat demand. Office buildings can achieve significant savings by installing zoned thermostats to turn off the heating systems when people are not using the space. They can also use fans and heat pumps to move heat from computer rooms, laundries, and restaurants into other areas of the buildings. Such measures, if they cost \$15 to \$20 per million Btu saved (unamortized capital cost) will cost the owners of the buildings less than continued high volume use of district heat.

**Table 66.—How Different Contingencies Can Affect the Total Cost of a Proposed District Heating System for Washington, D.C.**

Assume a hot water D/H system for Washington, D. C., from table 6 using midpoint cost values (1978 dollars) — all 4 zones

| Subsystem  | Transmission                         |   |  |  |  | Replacement<br>Of lost<br>electricity<br>capacity <sup>b</sup><br>10 <sup>6</sup> dollars | Total<br>capital cost<br>provided by<br>10 <sup>6</sup> dollars | Thermal load<br>D/H 10 <sup>6</sup><br>Btu/yr | Total capital<br>cost per<br>Btu delivered<br>10 <sup>6</sup> Btu/yr |
|--|--------------------------------------|---|--|--|--|---|---|---|--|
|  | line cost<br>10 <sup>6</sup> dollars | Local distri-<br>bution cost<br>10 <sup>6</sup> dollars | Building<br>retrofit cost<br>10 <sup>6</sup> dollars | Powerplant<br>retrofit <sup>a</sup><br>10 <sup>6</sup> dollars | Building<br>retrofit cost<br>10 <sup>6</sup> dollars |   |   |   |  |
| <b>Case</b>  |                                      |   |  |  |  |   |   |   |  |
| 1. Under current conditions with 100 percent of buildings connected . . .  | \$346.5                              | \$481.5   | \$184.5  | \$96.5   | \$331.0  | \$1,440.0   | 25,879  | \$55.64                                       |  |
| 2. Only 60 percent of the buildings are connected. . . . .   | 346.5                                | 288.9   | 110.7  | 96.5   | 304.5  | 1,147.1   | 15,527  | 73.88   |  |
| 3. Assume 40 percent conservation with 100 percent connected . . . . .   | 346.5                                | 481.5   | 184.5  | 96.5   | 304.5  | 1,413.5   | 15,527  | 91.03   |  |
| 4. Assume 40 percent conservation with 60 percent of the buildings connected . . . . .   | 346.5                                | 288.9   | 110.7  | 96.5   | 288.6  | 1,131.2   | 9,316   | 121.43  |  |
| 5. Assume loss of a major customer (10 percent of load) after installation with current conservation levels and 100 percent connection . . . . . | \$346.5                              | \$481.5   | \$184.5  | \$96.5   | \$324.4  | \$1,433.4   | 23,291  | \$61.54                                       |  |

<sup>a</sup>Powerplant retrofit is assumed relatively fixed cost, even with decrease in thermal load.  
<sup>b</sup>Replacement of lost electric capacity here assumes that one unit of electricity is gained for every five units of thermal load decrease. Stated more conventionally, five units of thermal energy are produced for every one unit of electricity sacrificed.

SOURCE: Office of Technology Assessment using data on district heating costs for Washington, D.C. system in Santini, et al., op. cit., for tables 9 and 10.

Given the relatively high energy use of American buildings compared to European buildings it is likely that building owners will continue to make investments that save energy at least over the next decade. Since a serious overestimate of district heat demand can lead to substantial increases in fixed costs per delivered Btu, it is important that the potential conservation steps by building owners be allowed for in the initial sizing of the district heating system and even encouraged before a final heat load is estimated.

**Competition With Other Utilities and Fuel providers.** If it is large enough, a district heating system can cut deeply into the most lucrative market of natural gas utilities and fuel oil dealers. The large users which are the best customers for district heating are also the best customers for other energy suppliers since transaction costs are low for the volume sold. To the extent that such competitors are strong in a community, it may be more difficult to get community-wide support for district heating.

## CONDITIONS FOR A SUCCESSFUL DISTRICT HEATING SYSTEM

Under high financing costs, the economic competitiveness of a capital-intensive technology such as district heating is fragile. Under such conditions a series of unlucky breaks can prevent a system from being economically viable except when heavily subsidized. Communities that are more likely to have successful district heating systems would have some distinct characteristics, although successful systems are certainly possible in communities without these characteristics:

1. Cold climate. This is not a required characteristic but it helps. A cold climate can have two impacts that reduce the costs of a district heating system. By increasing the peak heating demands of any given set of customers—multifam-

ily or high-rise office buildings—the relative cost per million Btu of distributing heat to that customer on the peak day is reduced. Furthermore, cities in cold climates generally have longer heating seasons and better load factors (ratios of average demand to peak demand). Table 67 shows the total heating degree days, peak degree days, and load factor for several cities in the United States. The low load factor of a city such as Memphis (0.19) compared to Milwaukee's (0.30) will directly increase the costs of district heating since revenues from a 35 percent smaller heat demand must pay for the same transmission and distribution system. All other things being equal, district heat costing \$9.67 per million Btu in Milwaukee will cost \$14.11 in Memphis.

**Table 67.—Climactic Influences on Heating Loads for Selected Cities**

| Region and city                    | Annual heating degree days | Temperature on heating design day (°F) | Degrees below 65° on heating design day | "Load factor" <sup>a</sup> |
|------------------------------------|----------------------------|--|---|----------------------------|
| <b>Northeast and North Central</b> |                            |  |   |                            |
| Boston . . . . .                   | 5,621                      | 9°                                     | 56                                      | 0.28                       |
| Milwaukee . . . . .                | 7,444                      | -40                                    | 69                                      | 0.30                       |
| Minneapolis-St. Paul . . . . .     | 8,159                      | -12°                                   | 77                                      | 0.29                       |
| <b>South and West</b>              |                            |  |   |                            |
| Los Angeles . . . . .              | 1,819                      | 40°                                    | 25                                      | 0.20                       |
| Baltimore . . . . .                | 4,729                      | 13°                                    | 52                                      | 0.25                       |
| Dallas . . . . .                   | 2,382                      | 22°                                    | 43                                      | 0.15                       |
| Memphis . . . . .                  | 3,227                      | 18°                                    | 47                                      | 0.19                       |
| Seattle . . . . .                  | 5,185                      | 26°                                    | 39                                      | 0.36                       |

<sup>a</sup>The load factor is calculated by dividing the total heating degree days by the Product Of degrees below 65°F on the heating design day (the systems designed peak load) times 365 days (annual HDD - design day HDD x 365 days)

SOURCE Santini and Bernow, source for fig. 4.

2. *A core of large, closely packed customers with strong commitments to district heating.* Such a group of customers can form a dependable nucleus of demand and revenues for district heating. The costs of a distribution system to such customers—if properly sized—should be at a minimum. Planning guides recommend that district heating systems sign “take or pay” or similar long-term contracts with such customers in the planning stage. Such contracts eliminate some of the uncertainty about future hookups and the size of future heat demands. The core of the St. Paul system will be a set of municipal buildings and several large commercial and industrial customers. Thirty year contracts will be signed with these customers before bonds can be sold to pay for the construction of the systems.<sup>23</sup> Other systems could use a new urban renewal area, a set of hospitals, or university buildings as the core customers.

Given the favorable economies of a district heating system for a core group of customers, there is a strong case to be made for starting with small viable district heating systems such as the Trenton System (box L) and adding sections only as a larger market **for district heat** proves feasible.

3. *A source of heat close to customers.* This characteristic minimizes transmission costs which can also be considerable. Technically, hot water can be transported up to 70 miles from a heat source to a city, but the transmission cost is proportional.

4. *Excellent project management to hold down construction costs.* District heating is an enormous construction job and it must be managed accordingly. Naive management can lead

to major cost overruns with devastating consequences for prices.

5. *Lowest possible financing costs.* Utility participation is probably essential to get relatively low-cost financing if the district heating system is to be privately built. As we have seen, however, it is likely to be necessary to subsidize debt service in order to have district heating prices competitive with other fuels at least in the early years. State or local industrial revenue bonds, with government guarantees will bring interest costs down somewhat. Regular revenue bonds that are tax exempt will bring interest costs down still further.

**Justification for Sponsoring and Subsidizing District Heating.** There are many hard-to-quantify reasons why a local or State government may wish to sponsor (and usually subsidize), a district heating project. District heating employs local workers, spends money locally and this is likely to have a local multiplier effect that stimulates local economic activity. District heating is also almost certain to stabilize energy prices for local building owners although it may take several, or many, years for the price of district heat to be substantially below competing fuels. A district heating system is a visible form of investment in a community and may add, both practically and symbolically, to the attractiveness of a community to future business and investors.

Nonetheless, it should be realized that district heating may prove to be expensive for the community or State. District heating systems may have to be subsidized both initially and over time if they get into a situation where revenues are insufficient to cover fixed **costs. These costs should** be fully appreciated and weighed against the expected benefits.

<sup>23</sup>James O. Kolb, op. cit. (source for box K).

## OPTIONS FOR FEDERAL POLICY TOWARD DISTRICT HEATING

The Federal Government may be wise to leave to the States the option of whether or not to subsidize district heating, since it is likely to be successful only in areas with very specific characteristics. However, there are several useful things the Federal Government can do short of actual subsidy.

- Improve the state of knowledge of district cooling. Can it be a viable combination with district heating for Southern cities?
- Improve the state of knowledge about the prospects for existing steam systems? Can they be retrofit for hot water? Improved in other ways?
- Consider the development of a plan to keep more steam systems from closing down. Tax forgiveness measures might be considered.
- Assist States and localities with the technical and other aspects of the marketing of district heating to potential customers including techniques for retrofitting buildings.

The greatest impact that the Federal Government is likely to have on district heating is indirect—through its interest rate policy. A drop of several percentage points in financing costs would make many nonviable proposed systems economically attractive.

**Chapter 7**

**Private Sector Efforts to Stimulate  
Energy Retrofit of Buildings**

# Contents

|  | Page       |
|--|------------|
| Traditional Businesses . . . . .                 | 198        |
| <b>Energy Services Companies. . . . .</b>        | <b>199</b> |
| <b>Capital Investment and Shared Savings. ..</b> | <b>200</b> |
| <b>-Savings Guarantee. . . . .</b>               | <b>201</b> |
| <b>Audits and Retrofits. . . . .</b>             | <b>201</b> |
| <b>Audits and Retrofit Quality Control ..</b>    | <b>202</b> |
| <b>Audit Only. . . . .</b>                       | <b>202</b> |
| <b>Audit Assistance to Utilities . . . . .</b>   | <b>203</b> |
| <b>Energy Management Systems Design...</b>       | <b>203</b> |
| <b>Computerized Energy Management</b>            |            |
| <b>Systems . . . . .</b>                         | <b>203</b> |
| <b>Prospects for Energy Service and Energy</b>   |            |
| <b>Management System Companies. ...</b>          | <b>204</b> |
| Traditional Lenders.. . . . .                    | 205        |
| Nontraditional Financing. .. . . .               | 206        |

## LIST OF TABLES

| Table No.  | Page       |
|--|------------|
| 68. <b>Energy Services and Building Markets for a Sample of Energy Service Companies and Energy Consulting Firms Primary Building Markets. ...</b> | <b>200</b> |
| 69. <b>Comparison of Capital Needs for EMS and ES Companies. . . . .</b>   | <b>204</b> |
| 70. <b>Sample Calculation of Investment Return From a Limited partnership to Purchase Offshore Oil-Drilling Equipment . . . . .</b>                | <b>207</b> |

## Private Sector Efforts to Stimulate Energy Retrofit of Buildings

---

Energy conservation retrofits in buildings represent a good investment—over time they generate a return on the dollar well above many opportunities available elsewhere in the economy. This fact suggests that there is money to be made in energy conservation, and consequently that there should be a strong private sector, profit-oriented market in retrofitting buildings. At the same time, it is well understood that new private sector responses to any need take some time to develop, just as new products often experience a 10-year period from conception to market availability. A look at private sector energy businesses directed at building retrofit indicates that while many traditional businesses have shifted focus to take advantage of available profit, some new and specially designed business ventures are emerging.<sup>1</sup>

With the rise in fuel prices and the increasing body of information on how to save energy, many entrepreneurs have started to look for ways to make money. Many policy analyses done from the perspective of Federal-level investment choices have demonstrated the economies available through using conservation instead of new fuel supply. These macroeconomic analyses have concluded that profit should result from the savings in fuel cost generated by conservation. Quantification of the “conservation market” is difficult, except to say that the numbers are very large. Roger Sant, former Federal Energy Administration (FEA), Assistant Administrator for Conservation and Environment now involved in his own private sector effort, has estimated that the total market for energy services of all types will generate some \$400 billion in new profit.<sup>2</sup> In addition to the

hundreds of small companies trying to get a piece of the energy action, major corporations are now entering the field. Reynolds Aluminum, for example, has announced the opening of a chain of stores stocking energy products, designed for affluent consumers trying to hold down fuel bills.

Energy conservation in buildings is complicated as a profit opportunity, due to the complexity of buildings and the variables represented by the behavior of building users and the climate (see ch. 3). Energy conservation also faces some special marketing problems, in that investments to save money in the future are often less attractive than investment to generate cash flow or expenditures to obtain products or services that are desired by the user (see ch. 4). In other words, people are not enthusiastic about spending money to avoid paying an expense they resent anyway. A final problem confronting the private sector is that there is an enormous number of products and services, and unlimited combinations of those products and services, that can be defined as “energy conserving.” The multiplicity of choice, the millions of decision makers involved, and the difficulty of selection make it hard for business to define the true market.

In addition to these marketing problems, the potential investors in substantial retrofits that are the main subject of this study—commercial and multifamily buildings—face two particular barriers examined in more detail in chapter 4. Most of these owners have access only to debt financing, and current interest rates mean that financing a major retrofit is extremely costly. The amount of interest paid out on a large retrofit project means that the time period before the retrofit actually results in a real dollar saving is greatly lengthened. The investment picture is further complicated by the fact that the savings may vary, due to uncertainties in the diagnosis of energy retrofit applications, the behavior of building occupants and the climate itself. Some

<sup>1</sup>The first section of this chapter is based on the references footnoted on the following pages covering energy service companies, plus *An Assessment of the Potential for Large Corporations to Provide Retrofit Services to Homeowners*, Robert Dubinsky, a Rand paper, July 1981, and the following interviews: Honeywell Commercial Services, McLean, Va., Aug. 11, 1981, Certain-Teed Corp., Washington, D. C., July 23, 1981, and OTA Advisory Panel, Washington, D. C., Apr. 27, 1981

<sup>2</sup>“Thinking Ahead” (Coming Markets for Energy Services), Roger W. Sant, Harvard *Business Review*, May-June 1980, p. 6.

companies entering the energy area are specifically oriented to meeting these problems of financing and uncertainty.

There has been no systematic analysis of the private sector response to conservation retrofits; most available information is anecdotal. This partly reflects the newness of the field and the question of what businesses to include. It also reflects the fact that new companies basing their effort on generating 3- to 5-year payback projects do not yet know if they will succeed. Until sufficient time has passed to allow analysis of actual costs, cash flow impacts, and returns, it will be difficult for firms to learn what investment characteristics clearly result in profitability. One aspect of the market pattern is already clear,

however. Most firms offering extensive auditing, major retrofitting, financing, and/or guaranteed savings for the residential sector are aimed at middle- and upper-income consumers. Similarly, commercial and multifamily building owners with some discretionary capital are likely to be the largest users of more sophisticated private energy services.

This chapter will describe briefly some of the traditional and new responses by business to the energy conservation opportunity. Two of the findings of this study—that financing and risk reduction play critical roles in accelerating urban buildings retrofit—have influenced the selection of examples and emphasis in describing the new companies.

## TRADITIONAL BUSINESSES

Rising energy costs have made it important and cost effective for consumers to purchase and install products to help cut energy use, and resulting energy cost. Retail merchants have increased the exposure given to energy-saving products. This retail sales market is largely directed to the homeowner or tenant who wants to keep fuel costs down, but who may not undertake a thorough analysis of the structure. The best known energy-saving products, such as insulation and weatherstripping, are likely to be featured in retail displays of this type. Insulation, storm windows, and those products typically associated with saving energy in cold climates have been the focus of much homeowner and building owner buying.

Rising energy costs also mean that it now pays consumers to invest more to hold down fuel cost than it used to. Accordingly, manufacturers have invested in producing and marketing products that were not cost effective in the early 1970's but are now. A good example of this shift is the larger market share of heating and air-conditioning appliances with high efficiency ratings. Federally required labels displaying energy consumption, and the actions of California and Minnesota in requiring energy efficiency minimums for appliances sold in those States, have reinforced a movement by some manufacturers

toward higher efficiency products, with corresponding advertising and market efforts.

Data compiled by the Carrier Corp. points out a continuing difference between appliances that are purchased directly by homeowners and tenants, and those installed principally by contractors, such as central air-conditioning systems. Products normally purchased directly by customers that showed a marked improvement in energy efficiency from 1978 to 1980 included refrigerators and refrigerator freezers (+ 16.2 percent), freezers (+ 11.5 percent), room air-conditioners (+5 percent), dishwashers (+15 percent), and clothes washers (+16 percent). The Carrier analysis attributes this increase to market forces.

in contrast, appliances purchased primarily by contractors such as central air-conditioning units, heat pumps, furnaces, and water heaters, which constitute 15 percent of the total national energy consumption, improved efficiency by only 1.1 percent. Carrier attributes even this increase to the force of the California standard for central conditioning, which was raised from 7 to 8 in 1979.<sup>4</sup> Since California represents a suffi-

<sup>3</sup>"Shipment-Weighted Average Efficiency (E ER)," Carrier Corp., Analysis of Industry Data, May 1981.

<sup>4</sup>1 bid.



ciently large portion of the central air-conditioning market, this change influenced manufacturing practices. Carrier concludes that if the California standard had not been strengthened, the national average would have actually decreased slightly. The lack of improvement in the energy efficiency of these appliances appears to reflect the importance of first cost to the contractor, who seeks to enter the market at the lowest possible price, thus shifting the operating cost to the buyer, while, on the other hand, appliances likely to be purchased directly by the users are beginning to reflect the reality of operating costs.

Another response to energy cost awareness within the traditional business framework has come from trade and professional groups. Architects and engineers, both groups with a major impact on building energy use and a large potential gain from understanding the energy market, have undertaken to train themselves to provide improved energy design and engineering services. Both groups became involved in the attempt to fashion new energy efficiency standards for building construction; the American Society of Heating, Refrigeration and Air-Conditioning Engineers (ASHRAE) developed the model for the building code revisions adopted in most States over the past 5 years; the American Institute of Architects was heavily involved in the development of guidelines for the proposed building energy performance standards. Both of these massive efforts at code reform resulted in extensive research and information dissemination among these groups. ASHRAE is now trying to develop a set of retrofit standards. Large architecture and engineering firms that have traditionally provided information and services for large commercial buildings

have developed the new skills now in demand by their clients.

Energy consulting firms, generally providing audits, specifications and guidance for retrofits and new buildings (but not installation or financing of retrofits), have flourished. One-third of the 4,000 members of the Association of Energy Engineers are energy conservation consultants, according to the Wall Street Journal.<sup>5</sup>

<sup>5</sup>"Energy-Consultation Business Booms as Building Operators Seek Savings." *Wall Street Journal*, June 16, 1981.

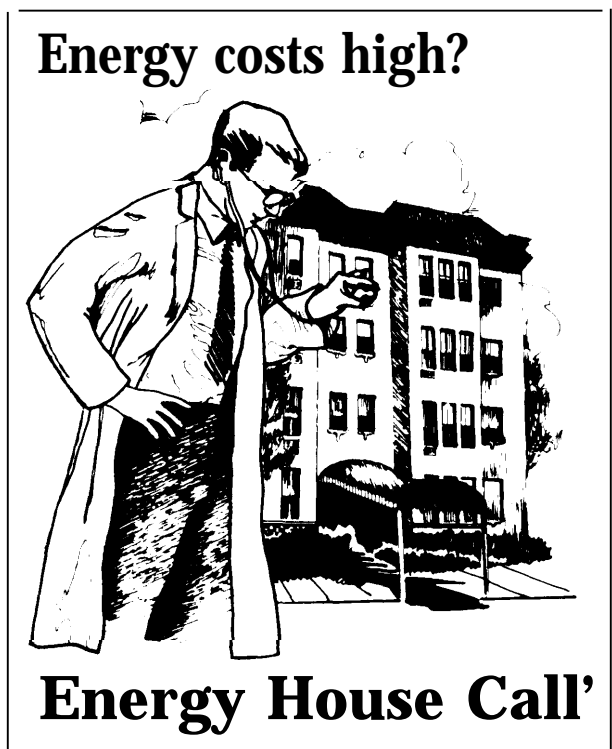

\* "Energy House Call" is a registered trademark of the Potomac Energy Group, Inc

Illustration and slogans from a business card used by a firm of "house doctors" in the State of Virginia

## ENERGY SERVICES COMPANIES

Distinctive and new business ventures are now underway in addition to the adjustments of traditional business to the "energy crisis." One of the underlying themes of these businesses is selling energy as a service, rather than as a commodity or Btu. This is a return to the early view

of Thomas Edison, who wanted to sell light instead of current. "The reason I wanted to sell light instead of current was that the public didn't understand anything about electric terms or electricity . . ." This view is also in line with the modern marketing approach that people

will buy what they understand. New businesses are building on this principle.

While there is little actual data on the performance of these firms, and no data on the impact of such firms on reduction in energy use, there seems to be a momentum building. OTA research consistently encountered a prevailing belief that "things are starting to roll." The attitude is that a momentum gathering behind conservation, driven primarily by price and supported by government emphasis and research, has created a private sector response that is about to pass through the embryonic stage to assume a major role in increasing retrofit. This enthusiasm is somewhat offset by the awareness that a number of firms have already come and gone, and others are barely surviving,<sup>6</sup>

The new companies offer a wide range of services, often tailoring their services to a client's need. While the energy audit is the basis of the business, other features may include in-

<sup>6</sup>Survey work for this report was completed in summer of 1980. As of fall 1981, OTA was unable to verify whether or not all of the firms described were still actually doing business in energy services. A number of energy newsletters and other sources reported that continuing high interest rates and other difficulties had lead to a cessation of operations of some firms.

stallation of equipment, supervision of contractors to ensure that installation is correct, financing, the guaranteeing of savings, or assuming full responsibility for providing energy to a building based on a contract with the building owner. Table 68 gives an idea of the variety available and the range of markets for a number of traditional energy consulting firms and for newer types of energy service companies. The next few pages describe briefly each of the companies in table 68.

### Capital Investment and Shared Savings

Scallop Thermal Management, Inc. (STM), subsidiary of Royal Dutch Shell in New York, markets energy services in the New York City and Washington, D. C., areas. STM offers to assume supervisory responsibility for the entire heating, cooling, and hot water systems, for a specified sum that is usually 10 to 12 percent below the building owner's budgeted cost. STM makes the initial low-cost investment and changes in procedures that are intended to dramatically reduce energy bills. After operating and monitoring the building for several months, STM may recommend that larger capital invest-

**Table 68.—Energy Services and Building Markets for a Sample of Energy Service Companies and Energy Consulting Firms Primary Building Markets**

| Services                               | Single-family low-income | Single-family moderate and high    | Multiunit dwellings 1-4 units | Multiunit dwellings 5 + units      | Small businesses             | Large commercial buildings       | Institutions                       |
|--|--------------------------|------------------------------------|-------------------------------|------------------------------------|------------------------------|----------------------------------|------------------------------------|
| Audit only                             |                          |                                    |                               | American Energy                    | American Energy              |                                  | American Energy                    |
| Audit assistance to utilities          | Cook Energy Enercom      | Cook Energy Enercom                | Energy Audit                  | Energy Audit                       | Enercom                      | Energy Audit                     |                                    |
| Audit and supervise/monitor retrofit   |                          |                                    |                               | Energy Investment                  | Energy Investment Seidman    | Energy Investment Seidman        | Energy Investment                  |
| Audit and retrofit/weatherization      | Energy Bank              | Energy Bank Energy Works Unlimited | Energy Bank Energy Unlimited  | Energy Bank Energy Works Unlimited | Energy Bank Energy Unlimited | Energy Bank Energy Unlimited     | Energy Bank Energy Works Unlimited |
| Energy management systems and hardware |                          |                                    |                               |                                    | Xenergy<br>Lockheed          | Xenergy<br>Honeywell<br>Lockheed | Xenergy<br>Lockheed                |
| Capital                                |                          |                                    |                               | Scallop                            |                              | Scallop<br>Pacific<br>Energy     |                                    |
| Savings guarantee                      |                          |                                    |                               |                                    | Ebasco<br>Diversified        | Ebasco<br>Diversified            | Ebasco<br>Diversified              |

SOURCE: Office of Technology Assessment.

ments be made, and will either make the investment or split the cost and savings with the building owner. STM assumes the total risk or profit for being able to reduce fuel bills to a point lower than the contract price.<sup>7</sup>

Pacific Energy Spectrum, Inc. (PES), Los Angeles, Calif., provides energy systems management services to commercial and light industrial building owners. PES will install equipment at no cash outlay to building owners. In order to finance initial investments, PES relies on pools of investors to form partnerships to take advantage of rapid payback and flow-through tax and accelerated depreciation benefits. Savings are shared by PES and the building owner according to a previously agreed-upon formula. At the end of the contract, PES will either sell equipment to the building owner at a depreciated value or remove it. PES customers include shopping malls, office buildings, and light manufacturing business owners in the Los Angeles area. These building owners are attracted to the PES approach because they are not required to invest large amounts of capital to achieve substantial savings.<sup>8</sup>

### Savings Guarantee

Ebasco Services, Inc., is a general architecture/engineering and construction services firm headquartered in New York City. It provides services to utilities, the commercial and industrial sectors, governments, and institutions. The company has established an energy conservation department which has expertise in lifecycle costing, building system design and operation and energy consumption, fuels and utility services.

In October 1979, Ebasco announced that its energy conservation department would offer to small- and medium-sized commercial and institutional clients energy audits that are guaranteed to save energy. The investor is guaranteed that the agreed-upon energy conservation investments will be recovered in 60 months or less through reduced energy costs, or Ebasco

<sup>7</sup>Mellon Institute, Energy Productivity Center, Preliminary Review of Energy Management Companies Securing the Commercial Building Market, July 22, 1980, pp. 4, 5, and 42.  
al bid., pp. 37-38.

will pay the differential. In addition, Ebasco will provide assistance in securing financing for retrofit costs, through banks, financial institutions or through groups of private investors. Ebasco does not do the actual weatherization or retrofit, but will secure contractors for clients and supervise the construction and installation activities. When the work is completed, an Ebasco representative will monitor energy use for 5 years. To date, Ebasco has provided audits for 17 hospitals, 28 universities, and a number of office buildings and industrial plants.<sup>9</sup>

Diversified Energy Systems (DES), King of Prussia, Pa., installs energy management systems which are guaranteed to reduce utility expenses by at least 15 percent. If DES fails to cut costs by the amount guaranteed, they will restore the building to its original condition and refund the customer's investment less the amount actually saved while the equipment was operating.<sup>10</sup>

### Audits and Retrofits

The Energy Bank, Boston, Mass., was founded in 1975 to provide home energy audits and has since expanded to include commercial audits, as well. Audits are offered directly to individuals/organizations or through public utilities and consumer groups. For example, the Energy Bank audits costs usually range from \$25 to \$45. The Bank is one of the few companies equipped to implement its recommendations. Because the Bank has its own crews, it is able to install a full range of improvements—insulation, window and door work, oil/gas heating systems, domestic hot water, and solar energy systems. Energy Bank surveys indicate that about 87 percent of its audit customers made substantial conservation investments because of the audits. The Bank will also assist clients in arranging financing. According to Energy Bank, loans for the purchase of materials and installation work are available through local banks.<sup>11</sup>

<sup>9</sup>Telephone conversation with Michael Munk, Ebasco, Inc., Energy Conservation Dept., Aug. 15, 1980, and Ebasco promotional material.

<sup>10</sup>Mellon Institute, Op. cit., p. 20.

<sup>11</sup>Letter of May 30, 1980, and attached promotional information on the Energy Bank.

Energy Unlimited (EU), New Britain, Conn., established in 1904, has broad experience in energy supply and demand, conservation techniques, and powerplant operation and maintenance. The company owns a cogeneration plant in New York and provides assistance to groups interested in installing district heating or cogeneration plants,

Through its fuel oil division, EU offers class A audits (designed by EU staff) to its oil customers at no charge. EU also conducts audits for commercial, institutional, and municipal clients. Clients can purchase materials needed to make recommended improvements and/or contract with EU to install the materials. According to an EU spokesman, clients are not pressured into purchasing EU materials or installation. Furthermore, EU will arrange for financing and in some cases, although rare, will provide the financing to meet the client's needs.<sup>12</sup>

Energyworks, Inc., is a West Newton, Mass., based energy service company established in September 1977. It conducts energy audits (about 800 yearly) and retrofits as well as providing energy conservation training to a variety of clients: residential, municipal and institutional. Audits are offered directly to clients or through utilities. Furthermore, Energyworks will assist its clients in arranging for financing needed to implement its recommendations.

### Audits and Retrofit Quality Control

Seidman & Seidman is an accounting firm located in Grand Rapids, Mich. As energy prices began escalating, Seidman & Seidman clients sought their advice on cutting energy costs. In response to this, the company's management advisory services division developed energy management techniques, including energy reporting systems, Btu accounting and tax credit analysis. For the last 4 years, the company has conducted audits, performing about 20 to 30 per year for commercial and industrial clients. Audits have been conducted on small- and medium-sized commercial buildings, schools, hospitals, and a manufacturing plant. At the client's

<sup>12</sup>Telephone conversation with Mr. Benson, Energy Unlimited, Sept. 8, and Oct. 2, 1980, and letter dated Oct. 28, 1980.

request, Seidman & Seidman will monitor the work to be sure that the vendor has done the job correctly.<sup>13</sup>

Established in 1973, Energy Investment (EI), Boston, Mass., is an energy consulting firm specializing in the development of energy management and cost reduction programs for business and industry. Its primary service is an audit, which is conducted onsite and provides engineering and financial evaluation. EI clients include light and heavy manufacturing plants, office buildings, retail stores, schools, hospitals, and apartment complexes. The company will provide construction supervision and other follow-on implementation services to ensure that conservation measures are implemented promptly and efficiently for actual energy savings. Other energy services offered include designing centralized energy accounting systems and conducting boiler conversion feasibility studies. In addition, EI has authored manuals and conducted workshops to train and motivate client's personnel in pursuing conservation goals. EI claims that its clients typically implement their recommendations to achieve 20 percent energy savings annually, with a payback period of about 2 years.<sup>14</sup>

### Audit Only

American Energy Services (AES), Cambridge, Mass., provides help to organizations in need of managing their energy consumption. Within the last 2 years, AES has designed a building energy audit computer program and auditing procedures. This computer program is used to analyze energy use for clients. Over 80 energy audits have been done for **AES** clients, which include institutional, commercial, residential, and industrial sectors. In addition, **AES** has developed and implemented residential audit programs for utilities and fuel oil dealers.<sup>15</sup>

<sup>13</sup> Telephone conversation with Thomas Hollen, Aug. 14, 1980, and Seidman and Seidman Informational Brochure, and letter dated Aug. 14, 1980.

<sup>14</sup> Energy Investment Inc. Resume (no date).

<sup>15</sup>American Energy Services, Inc., letter dated Aug. 15, 1980, and attached information; telephone conversation with Ann Hudson on Aug. 14, 1980.

## Audit Assistance to Utilities

Enercom, Inc., Tempe, Ariz., has been providing support services to the utility industry since 1975. About 90 gas and electric utilities located in 27 States are currently using Enercom computer systems for home and small commercial audits. Enercom provides a custom designed computer system that can be taken into a home for utility-tailored onsite audit. The system takes into account climate, rate structures, labor and product costs, and construction techniques. According to the company, all of the utilities under contract are using or soon will be using the Enercom system to comply with the Residential Conservation Service program. In addition to its computer services, Enercom will train or supply some or all of the needed auditors to utilities, through Equifax Services, Inc., a nationwide property inspection company with considerable auditing experience. Furthermore, Enercom will provide marketing and advertising assistance to help utilities promote audits to customers.<sup>16</sup>

Cook Energy, Chagrin Falls, Ohio, is another company actively pursuing the utility home energy audit market. It is presently assisting 12 utilities in establishing home energy audit programs. The company offers a computerized audit program and conducts auditor training programs for utilities. The computer program used by Cook Energy is available nationwide on a time sharing basis from Boeing Computer Services and Fukon Data Systems.<sup>17</sup>

Energy Audit, Inc., Cranston, R. I., also provides computerized energy audit programs to the utility industry for use in residential (includes apartment buildings) and commercial buildings. Like the other two companies, Energy Audit will also train auditors.<sup>18</sup>

Planergy, Inc., Austin, Tex., is an energy management and conservation services firm established in January 1977. During the past 3 years,

the firm has developed energy management programs and conducted auditor training workshops in 22 States. Its clients include hospitals, schools, government, and utilities. In addition to training auditors for the utility industry, planergy will provide technical and management support to utilities.<sup>19</sup>

## Energy Management Systems Design

Xenergy, Lexington, Mass., is an engineering consulting firm incorporated in 1975. The company has designed computer energy management systems for industrial, commercial, and public clients. According to an Xenergy official, about 50 percent of its workload is residential (multifamily housing), industrial, commercial (hotel/motel, office buildings and restaurants) and institutional energy auditing. Xenergy does not perform installation work; however, it will assist clients in securing financing to implement its recommendations.<sup>20</sup>

## Computerized Energy Management Systems

Honeywell's expertise in computers and controls systems naturally expanded into computerized energy management systems. Honeywell offers a wide range of hardware and software, and its buildings operations service system is available nationwide on a time-sharing basis. To date, Honeywell's energy management system has primarily been designed for large commercial complexes, although a system for small commercial buildings has been recently introduced. Honeywell manufactures its own equipment and its staff work directly with building owners who purchase and contractors who sell the systems. To assist its clients, Honeywell will also provide training classes on load management and energy conservation.<sup>21</sup>

Lockheed Electronics Inc., Plainfield, N. J., markets an energy management system which

<sup>16</sup>Enercom Marketing Information and Telecon of Sept. 8, 1980, with Jim Marquedt.

<sup>17</sup>Telephone conversation with Bill Robertson, Cook Energy, Sept. 8, 1980.

<sup>18</sup>Telephone conversation with Pau I Calego, Energy Audit, Inc., Sept. 4, 1980, and Energy Audit promotional material, dated 1979.

<sup>19</sup>Planergy Informational Material and telephone conversation of Sept. 8, 1980.

<sup>20</sup>Telephone conversation of Aug. 14, 1980, and Xenergy resume.

<sup>21</sup>Telephone conversation of Sept. 11, 1980, and letter dated Oct. 7, 1980, and attached information.

can be used in any size commercial building. The system uses a centralized minicomputer programed to take English commands and designed with modular components for expansion capability. The system costs \$100,000. Lockheed offers a computer training course to building management personnel who purchase or lease the equipment. Lockheed has recently initiated a program to test the feasibility of using a master station to monitor and control energy consumption for 20 hospitals. The hospitals will use the money saved from lower utility bills to pay for the system.<sup>22</sup>

### Propsects for Energy Service and Energy Management System Companies

If energy service companies are to play a major role in reducing energy consumption in the commercial sector, they must expand beyond their present markets and services. Energy services operating in the commercial sector currently consist almost entirely of computer systems programed primarily for large commercial buildings and complexes. For this building type, control systems are often the most appropriate way of controlling energy consumption. Large commercial building owners have the financial resources to purchase the hardware and hire the personnel needed to monitor building energy consumption. However, this is not the case with the vast number of small- and medium-sized commercial buildings, many of which are located in cities. Small buildings owners do not have the capital to invest in equipment and personnel to operate the equipment nor can they assume all the risk should the system fail to achieve specified energy savings. In general, these owners will require more services to meet their needs. To appeal to this market segment, energy service (ES) companies will have to become energy management system (EMS) companies and expand their services to include ongoing management, financing, and savings guarantees.<sup>23</sup> Some companies have organized

<sup>22</sup>Mellon Institute, Op. Cit., P. 33.  
<sup>23</sup>U.S. Department of Energy, Office of Conservation Policy and Evaluation, *Energy Management Systems: An Industry Appraisal*, August 1980, pp. 16-18.

around these goals. Scallop Thermal Management Corp., which has offered energy services in Europe for the past 11 years, has already secured contracts for several buildings in New York City and has selected apartment buildings as its primary target. Also, Honeywell is now testing the full energy services concept.<sup>24</sup>

A major obstacle to the expansion of services is capital. An EMS company will need 10 times more capital in order to move toward the full energy services concept (see table 69 for a comparison of EMS and ES companies' capital needs). Generally, the large corporations in the EMS business are financially sound and can supply the needed capital. However, their financial commitment is determined by the role energy services will play in the corporation's future. [In other words, if energy services figure importantly in the corporation's future, the capital will more than likely be available. For smaller EMS companies, the capital supply requirement will be a much greater problem. Small EMS companies face the same problems as other small businesses—they are not publicly held and debt availability is limited. Often the capital needed for expansion is obtained through the sale of the company. Because of the great market potential for energy services, EMS companies may be able to attract the needed capital. If not, serv-

<sup>24</sup>Roger Sant, "Coming Energy Markets," *Harvard Business Review*, May/June, 1980, pp. 20, 24.

**Table 69.—Comparison of Capital Needs for EMS and ES Companies**

|                                 | EMS company                | ES company                |
|---------------------------------|----------------------------|---------------------------|
| Type of sales                   | Direct                     | Financed                  |
| Terms of payment                | 60 days                    | 5 years                   |
| Annual sales                    | \$10 million               | \$10 million              |
| Maximum capital need to finance | \$1.7 million <sup>a</sup> | \$20 million <sup>b</sup> |
| Terms of payment:               |                            |                           |

<sup>a</sup> 60 days x \$10m sales/yr = \$1.7 million / 360 days/yr  
<sup>b</sup>Represents maximum amount financed in the fourth year of sales. In its first year of sales, the company would need \$8 million (\$10 million x 80 percent); the second year, \$14 million (\$10 million x 80 percent + 10 x 60 percent); the third year, \$18 million; and the fourth, \$20 million. This assumes that payments are made evenly over the 5-year term.

SOURCE: U.S. Department of Energy, Office of Conservation Policy and Evaluation, *Energy Management Systems: An Industry Appraisal*, August 1980, pp. 16-18.

ices will not expand and market penetration will suffer.<sup>25</sup>

Energy services companies will probably have a limited impact on the residential sector. Generally, ES companies have limited financial and manpower resources. Consequently, they focus their advertising and marketing on those middle- and upper-income groups that are likely to be able to afford their services and exclude those that cannot. Low-income people, for example, probably cannot afford the cost of an

energy service company audit and will have to rely on utility audit programs.\*

Because utilities have access to their customers and can support extensive promotional advertising campaigns, they will probably penetrate the residential audit market faster than ES companies. ES companies will appeal to a smaller audience of paying customers who will expect more specific information and will be more inclined to implement energy savings recommendations.

<sup>25</sup>U.S. Department of Energy, *Energy Management Systems*, August 1980, pp. 26-27.

\*By law, utilities are required to conduct residential audits on request (see ch. 9, Public Sector).

## TRADITIONAL LENDERS

As indicated in chapter 4, financing large retrofits and assuming some of the risk have been identified by OTA as critical factors in increasing retrofit, particularly in commercial and multi-family buildings.

Some financial institutions have been leaders in offering help to customers facing rising energy costs. Most of the work in this area has been with homeowners, rather than commercial investors. Savings and loans (S&L), which have historically financed three out of five home loans, have necessarily taken an interest in this issue. Available information suggests that the strong involvement of S&L (and banks) in energy lending reflects the commitment of a leader—just as cities with active energy programs generally reflect a mayor's strong commitment. Richard L. Bryan, president and chairman of the board of Des Moines Savings & Loan, moved his S&L into the energy business in a big way in early 1977. Special loan programs were offered to homeowners, and mortgage customers and others were offered up to \$2,000 at 1 percent below market rates. Appraisers visiting properties for new mortgages started checking energy features (and carrying stepladders to check attic insulation). Each new loan customer was given a calking gun and a tube of calking, and the S&L

opened an energy information center in its Des Moines office.<sup>26</sup>

According to Bryan, these steps were taken because energy investments in new and existing homes would result in homeowners being better able to maintain their financial security, and because of his strong personal belief in the national importance of using energy more efficiently.

While it is true that the number of home mortgage defaults have risen and that energy costs have also risen dramatically, it is difficult to assign the burden of defaults to energy costs alone. Rising energy costs do affect the disposable income of loan holders, and so lenders financing large numbers of home purchase and improvement loans can clearly justify a concern with energy. On the other hand, the small size of most retrofit loans (for homes) means that the loans are not attractive to a lender, and may be of negative financial value.

There may be methods of subsidizing retrofit financing which offer particular appeal to lenders. Some Federal programs, notably the Solar

<sup>26</sup>"Energy Conservation: It Pays You: So Says Des Moines Savings & Loan," *Des Moines Magazine*, Dec. 5, 1979.

Energy and Energy Conservation Bank, have been designed to work through existing lenders. The loan subsidy for the borrower may apply against interest or principal. When the subsidy is used to offset interest costs, for example lowering the rate from 18 to 13 percent, the lender receives the difference. Depending on the calculations used in computing the payment, the lender can legitimately profit on the difference in value between a lump sum paid at the beginning of the loan term as a subsidy, and the same amount paid monthly over the full term of the loan by the borrower. Subsidies of this type, which could be offered by States or localities as well as the Federal Government, could increase the interest and participation of lenders,

### Nontraditional Financing

Building owners who wish to retrofit large buildings may well be faced with cash flow problems, costly debt financing, and uncertainty about return on investment. To some extent, the ES companies have developed methods to relieve these concerns but still provide mutual gain. While the potential for syndicating equipment ownership has been mentioned in descriptions of some of the ES companies, it is useful to focus directly on these mechanisms, which form the basis for many "deals" that could accelerate retrofit.

It may often be profitable for people other than the owner of the building to finance the entire investment. The arrangement is conceptually the same as the many limited partnerships that now characterize the real estate market in general (see ch. 4), and the current use of these partnerships in multifamily and commercial building properties may make the transition easier. The basic structure of the arrangement is as follows: a number of investors, presumably individuals in the 50-percent tax bracket, decide to pool resources for investment purposes. They provide funds for the purchase of equipment necessary to improve the energy efficiency of a specified building, based on the recommendations of an auditor or engineer. The investors, who have organized as a limited partnership for

the specific purpose of the investment, enter into an agreement with the building owner as to terms of use, payment for the energy used, etc. Terms of payment by the owner are much less significant than the tax advantages of the partnership, except that the agreement may not represent a sale disguised as a lease or service. The partnership profits from the flow-through depreciation of the equipment, from the investment tax credit, and from the energy tax credit if the equipment qualifies. The arrangement will be structured to optimize the return to the investors. The arrangement will normally conclude at a point about 5 years from initiation, when maximum tax advantages have been gained by the investors. Assuming that equipment is reasonably priced and based on actual specifications for the building, this method shows promise of making funds available for many owners lacking in capital and averse to risk.

Details of syndicated investment vary according to each project and the profile of the investors, and details are semi proprietary in nature. The investment breakdown shown in table 70 is based on purchases of equipment for operating business, such as offshore supply and utility boats, river barges, drilling rigs, executive aircraft, and other kinds of equipment. While the total investment pool is larger than would be likely for an investment in buildings, the structure of the package gives an idea of the ways return on investment can be developed through a partnership approach.

A variation on the method, which has been suggested by Ebasco, is the formation of investor pools by tenants for retrofitting their own buildings. This would circumvent the classic lack of incentives facing multifamily structures for saving energy (see ch. 4) by allowing the tenants themselves to gain from installing the equipment, with no loss even if they move. This assumes the tenants have sufficient tax liability to use the tax benefits.

Leasing arrangements serve a similar purpose. Recent changes in the tax law may offer increased opportunities for profitable leasing by widely held corporations, but no estimate of this impact can be made yet.



**Table 70.—Sample Calculation of Investment Return From a Limited Partnership to Purchase Offshore Oil-Drilling Equipment**

|   |                              | Investment Company X |                     | Minimum purchase                    |                               |
|---|------------------------------|----------------------|---------------------|-------------------------------------|-------------------------------|
| 4,000 limited partnership interests   |                              | \$5,000 per interest |                     | 2 interests                         |                               |
| Expected returns based on Economic Recovery Tax Act of 1981 for an initial investment of \$10,000 |                              |                      |                     |                                     |                               |
|   | Annual investment tax credit | Annual cash flow     | Pre-tax loss (gain) | Taxes saved (paid) (500/0 taxpayer) | After tax cumulative benefits |
| 1981  | \$ 950                       | \$ 325               | \$ 425              | \$ 212                              | \$ 1,487                      |
| 1982  | 700                          | 1,100                | 1,609               | 804                                 | 4,091                         |
| 1983  |                              | 1,200                | 2,508               | 1,254                               | 6,545                         |
| 1984  |                              | 1,300                | 1,533               | 767                                 | 8,612                         |
| 1985  |                              | 1,400                | (1,400)             | (700)                               | 9,312                         |
| 1986  |                              | 1,500                | (1,500)             | (750)                               | 10,062                        |
|   | Pretax cash flow             | Taxes                | After tax cash flow | After tax cumulative benefits       | Compounded after tax return   |
| 1987 sale with:   |                              |                      |                     |                                     |                               |
| 8% inflation . . .  | \$15,711                     | \$7,339              | \$8,372             | \$18,434                            | 17.8                          |
| 100/0 inflation . .   | 18,303                       | 7,876                | 10,427              | 20,489                              | 19.8                          |
| 120/0 inflation . .   | 21,135                       | 8,463                | 12,672              | 22,734                              | 22.1                          |

**Assumptions:**

- . In addition to the \$8 million in barges already contracted for company X anticipates to purchase several offshore supply vessels and a unit tow, consisting of a tank barge and towboat.
- Capital gains rate of 20 percent.
- ITC earned over 5 years instead of 7 years.
- Depreciation over 5 years using the new formula set forth in the Economic Recovery Tax Act of 1981.
- . Sale at end of sixth year instead of at end of ninth year.

There can be no assurances that the above expected returns will be realized.

|                         | Price to public | Selling commission | Proceeds to partnership |
|-------------------------|-----------------|--------------------|-------------------------|
| Per interest . . . . .  | \$ 5,000        |                    | \$ 4,575                |
| Total minimum . . . . . | \$ 7,500,000    | \$ 637,500         | \$ 6,862,500            |
| Total maximum . . . . . | \$20,000,000    | \$1,700,000        | \$18,300,000            |

SOURCE Based on a prospectus filed with the Securities and Exchange Commission in the summer of 1981

**Chapter 8**

**Potential Role of Utilities in Improving the  
Energy Efficiency of Buildings**

# Contents

|  | Page |
|--|------|
| Context for Utility Decisionmaking. ..   | 212  |
| Federal Power Marketing Agencies and<br>Publicly Owned Systems. . . . .  | 216  |
| Varieties of Energy Conservation Programs. . . . .   | 220  |
| Energy Conservation Programs Primarily<br>for Public Relations Purposes in Gas<br>and Electric Utilities. . . . .                        | 220  |
| Energy Conservation Programs<br>Launched by Utilities To Earn Money<br>as Unregulated Subsidiaries. . . . .                              | 220  |
| Gas Utility Company Profits From Energy<br>Conservation Programs. . . . .  | 222  |
| Electric Utility Conservation Programs<br>To Permit Postponement or<br>Curtailment of Plans To Build<br>New Generating Capacity. . . . . | 224  |
| Consumer Perspective on Utility<br>Conservation Programs. . . . .  | 226  |
| Retrofit Business Perspective on Utility<br>Conservation Programs. . . . .   | 228  |
| Conclusion . . . . .   | 228  |
| Appendix 8A.—Electric Utility Statistics. . . . .  | 230  |
| Appendix 8B.—Effects of Issuing Stock at<br>Different Market Prices Relative to<br>Book Values. . . . .                                  | 232  |
| Appendix 8C.—Comparison of State<br>Electric Utility Regulatory Practices. . . . .   | 234  |

## LIST OF TABLES

| Table No.  | Page |
|--|------|
| 71. Rate Increases and Demand Growth<br>Over the Past 5 Years for Utilities<br>in Various Urban Areas. . . . . | 214  |

| Table No.   | Page |
|---|------|
| 72. Projected Reserve Margins: July 1980<br>and February 1981 . . . . .   | 216  |
| 73. Private Utility Return on Equity. . . . .   | 216  |
| 74. Publicly and Privately Owned Systems<br>Within the U.S. Electric Power System,<br>1979 . . . . .                | 217  |
| 75. Municipal Utility Systems Serving<br>Cities With Populations Over 50,000...218                                  | 218  |
| 76. Audits per Year Performed by Selected<br>Utilities . . . . .  | 221  |
| 77. Potential Impact on Capacity<br>Requirements and Electric Demand of<br>Different Conservation Programs. . . . . | 225  |
| 78. Utility Characteristics That May<br>Influence the Development of<br>Conservation Programs. . . . .              | 227  |

## LIST OF FIGURES

| Figure No.   | Page |
|--|------|
| 52. Dominant Source of Energy/Fuel for<br>Residential and Commercial Buildings. . . . .                          | 211  |
| 53. Sources of Energy for Electricity. . . . .   | 213  |
| 54. Trends in U.S. Natural Gas Supplies. . . . .   | 223  |
| 55. NEESPLAN Projections of Demand and<br>Generating Capacity Requirements,<br>1981 -95. . . . ., . . . . ., 224 | 224  |
| 56. NEESPLAN projected Load Profile,<br>1980-95 . . . . ., 226   | 226  |

## BOX

|  | Page |
|--|------|
| N. TVA Home Insulation Program—Audits<br>and Finance to Reduce Demand. . . . . | 219  |

## Potential Role of Utilities in Improving the Energy Efficiency of Buildings in Cities

In response to the problems caused by sharp increases in oil and gas prices and periodic oil and gas shortages, and sharp increases in the cost of capital and powerplants, many utilities have undertaken energy conservation programs. Both the Tennessee Valley Authority (TVA) (see box N below) and Pacific Power & Light, for example, have aggressive programs for marketing energy audits and retrofits using zero- or low-interest loans.

To what extent are other utilities likely to follow the leadership of these utilities with unusually strong energy conservation programs? The

purpose of this chapter is to examine the several motives utilities have for energy conservation programs and to assess the likelihood that utility programs will contribute significantly to the large-scale retrofit of city buildings.

This chapter discusses the incentives of both gas and electric utilities to develop building energy conservation programs. Natural gas is the dominant source of energy for residential and commercial buildings in 27 out of 50 States (see fig. 52). Electricity is the dominant source of energy for buildings in only eight States. (Heating oil is the dominant source in 15 States.)

Figure 52.—Dominant Source of Energy/Fuel for Residential and Commercial Buildings

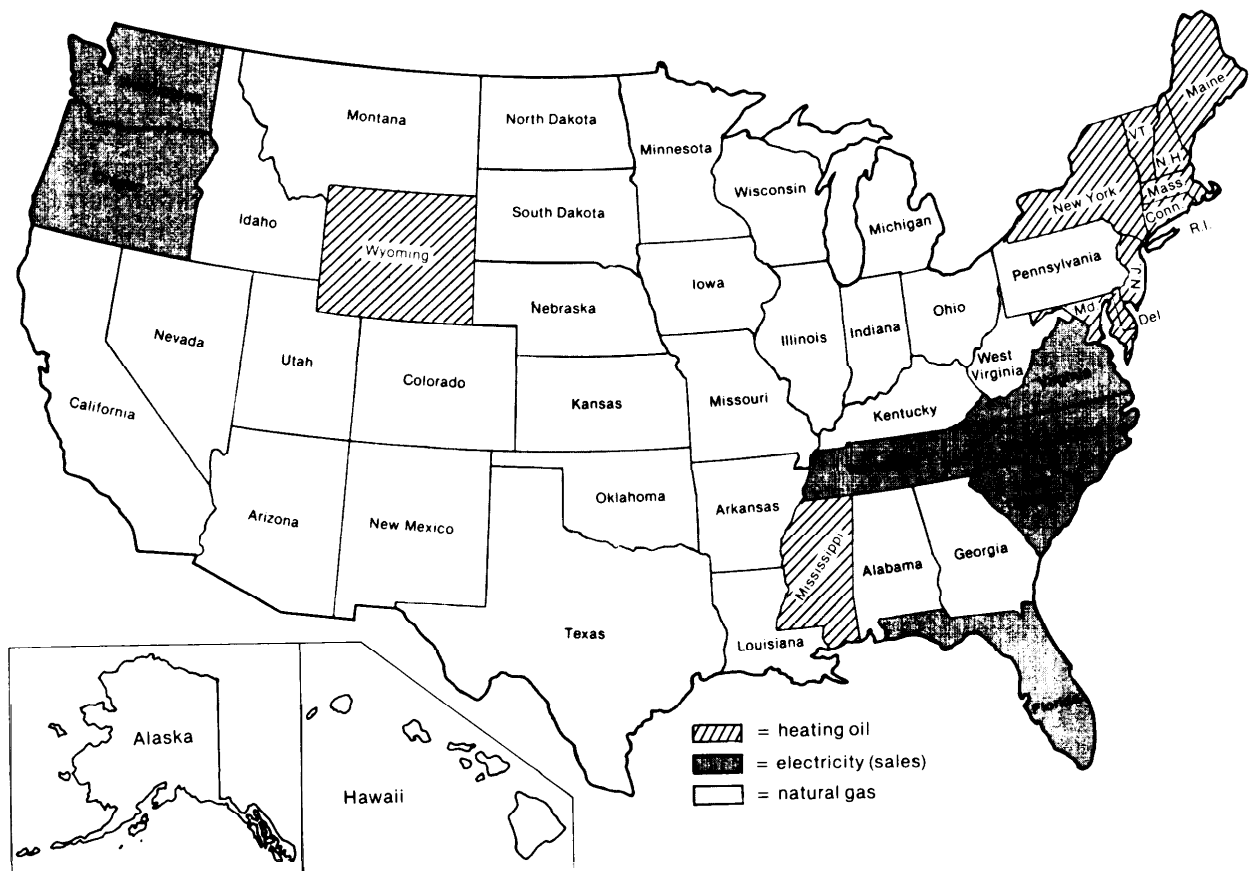

SOURCE: Department of Energy, April 1980 State Energy Data and the Office of Technology Assessment

Many utilities sell both gas and electricity. Of the 56 electric utilities listed in table 78 below, 25 also sell natural gas.

- For both gas and electric utilities, audit programs can improve customer relations in a time of sharp increases in prices.
- For both gas and electric utilities, unregulated energy management subsidiaries can be profitmaking.
- For a few gas utilities, savings in gas used by regular customers can be used profitably to sell to new customers, or at greater prices.
- For certain electric utilities certain kinds of

energy management programs will allow postponement of the construction of a new generating plant.

Each of these possible reasons for an energy management program will be discussed first from the point of view of utilities considering such programs. Consumers of electricity and potential competitors of utilities for the energy management business also have reasons for providing or withholding support from utilities seeking public authority to conduct such programs. These two additional points of view will be discussed at the end of the chapter.

## CONTEXT FOR UTILITY DECISIONMAKING

Most observers of the electric utility industry in 1981 concur that the industry is in trouble resulting from failure to adjust to a set of changed circumstances in the 1970's that brought to an end the golden era of electric utility prosperity of the previous two decades. The symptoms of the trouble include declining real returns on equity (for investor-owned utilities), declining coverage of interest on debt, deteriorating bond ratings, and low market-to-book ratios of stock values.<sup>1</sup> Some utilities and some observers of utilities have recommended energy management programs as one of the responses to this deteriorating situation.

Gas utilities, which distribute natural gas but do not have responsibility for producing it, also confront the results of higher prices and slower growth in demand since the embargo. Following are the most important changes to have affected electric and gas utilities over the decade:

**Gas Utilities.** Average prices for residential use of natural gas almost quadrupled from 1970 to 1980, increasing from \$1.06 per million Btu

to \$3.81 per million Btu.<sup>2</sup> The numbers of residential heating customers continued to increase but far more slowly than in the two previous decades. By 1978 and 1979, the number of natural gas customers was increasing at less than 1 percent per year.<sup>3</sup> In quantities of natural gas sold, residential and commercial sales of natural gas were essentially stagnant from 1976 to 1980 and industrial sales decreased from the early 1970's.<sup>4</sup> Natural gas distribution companies collect a distributor's markup on the wholesale gas sold to them by the natural gas production and pipelines companies. Increased prices for natural gas at the well head do not result in increased distributor's profits and stagnant or declining sales makes it harder to carry the cost of the distribution system. The gas distribution companies bear the brunt of consumer resentment of increased prices although the companies do not profit from them.

**Electric Utilities.** A set of semiindependent changes in the circumstances of electric utilities have brought about the current situation. They are:

Rapidly increasing prices and threatened shortages of fuel oil and natural gas. Utilities

<sup>1</sup>This section draws on background on the electric utility industry prepared by OTA for a forthcoming report, Cogeneration. It also draws on several published sources: Leonard S. Hyman, *The Development and Structure of the Electric Utility Industry*; Merrill Lynch Pierce Fenner and Smith, Institutional Report, New York (December 1980); Charles M. Studness, "Genesis of the Current Financial Plight of the Electric Utilities," *Public Utilities Fortnightly* (June 19, 1980).

<sup>2</sup>Energy Information Administration, *1980 Annual Report to Congress*, April 1981.

<sup>3</sup>American Gas Association, *1979 Gas Facts*, 1980, p. 72.

<sup>4</sup>American Gas Association, op. cit., p. 83.

relying on oil and natural gas for electricity generation have had to increase their prices very rapidly. These are predominantly in the East and Southwest as is clear from the map of fuels used in producing electricity shown in figure 53. To avoid paying the fuel cost of oil and gas and avoid problems of fuel shortages, they have attempted to shift to far more capital intensive nuclear and coal generating plants.

Increasing powerplant construction costs. Over the decade, the cost of a nuclear or coal powerplant has increased much faster than the cost of living and is projected to continue to increase rapidly over the next decade. TVA's first nuclear powerplant came on line in 1975 and cost \$270 per kW of capacity. Another TVA nuclear powerplant scheduled to come on line

in 1989 is estimated to cost \$2,400 per kW of capacity, a ninefold increase in the industry as a whole, the average cost per kW of generating capacity increased from \$166 in 1973 to \$796 in 1978.<sup>6</sup> The reasons for this increase include a shift to more expensive forms of electric generation using coal and nuclear energy, and more environmental and safety requirements.

Increasing cost of financing. Increased cost of finance over the decade multiplied the impact of increased construction costs. Interest on new long-term debt issued by investor-owned utilities that had hovered below 6 percent in the

<sup>6</sup>Robert L. Sansom, *Major Policy Issues Facing the Tennessee Valley Authority and Its Rate Payers*, a report submitted to the Committee on Environment and Public Works, March 1981.

<sup>6</sup>Hyman, *op. cit.*, p. 48.

**Figure 53.—Sources of Energy for Electricity**  
(all sources contributing more than 100 trillion Btu to a particular State)

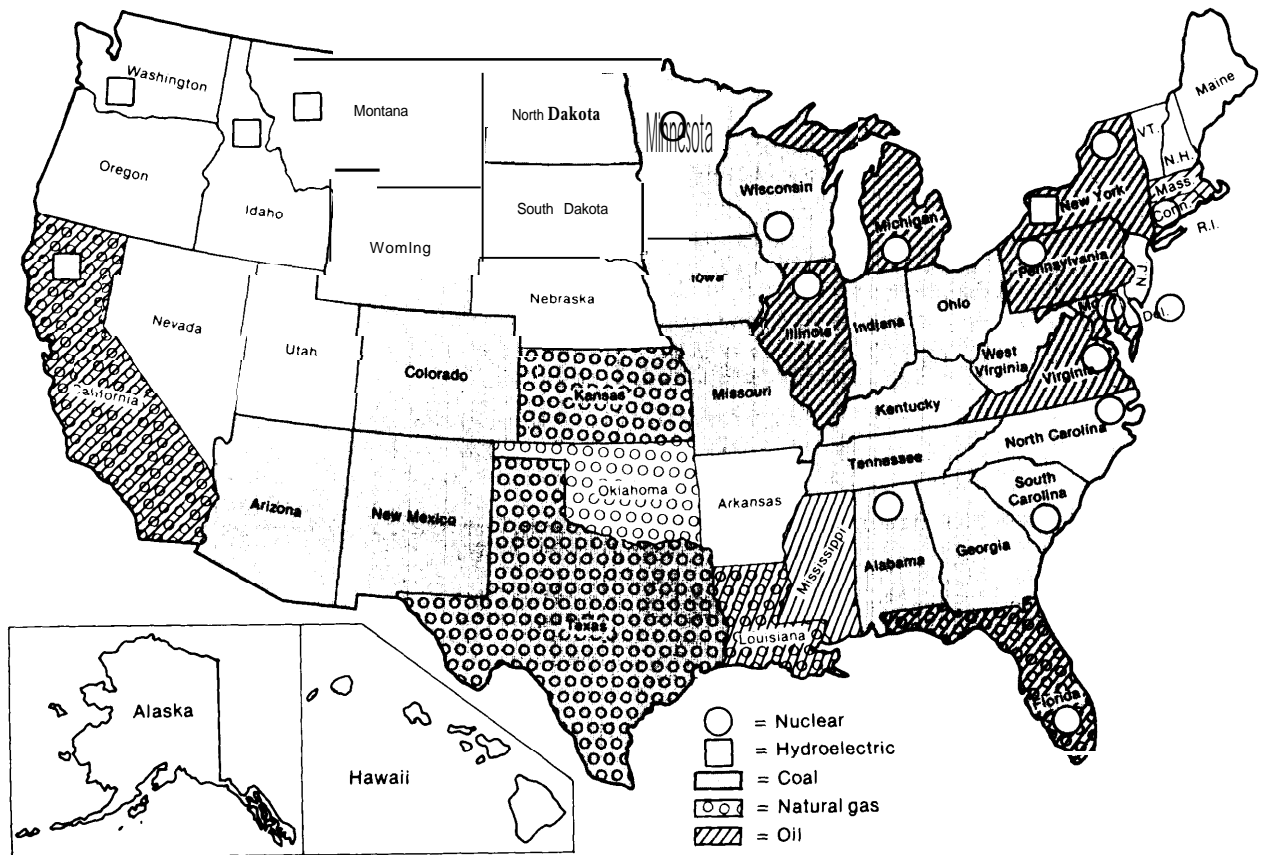

SOURCE: Department of Energy, April 1980 State Energy Data.

mid-1960's, rose to about 8 percent by 1973, and climbed to 14 percent by 1980. Increase in average interest rates was due partly to the general increase in interest rates over the decade and partly to large-scale downrating of utility bonds.<sup>7</sup> Publicly owned utilities and Federal power agencies (discussed below) experienced a similar increase in the interest cost of their generally lower priced debt.<sup>8</sup>

At the same time, equity capital also became more expensive for investor-owned utilities. A combination of competition from high-interest rates in the bond market and decreasing confidence in utility stocks (especially following Consolidated Edison's failure to pay a dividend in 1974) has caused a sharp drop in the average price of utility stock. The ratio of the market value of utility stock to its book value has fallen from a high of 2.35 in 1965 to about 1.0 in 1973 to 0.80 in 1978.<sup>9</sup> In 1981, the stock of virtually all the major utilities sells at a price below book value (shown in the statistics on 59 utilities and utility holding companies in app. A). For stock selling below book value, more shares must be issued to raise the same amount of capital than if the stock were selling at book value. Each sale of stock at below book value drives the market price down still further and dilutes its value for existing stockholders (see the explanation of this phenomenon in app. B).

<sup>7</sup>Edison Electric Institute, Statement presented at a Public Conference on the Financial Condition of the Electric Utility in the United States, sponsored by the Federal Energy Regulatory Commission, Mar. 6, 1981.

<sup>8</sup>See Sansom, op. cit., p. 5.

<sup>9</sup>Hyman, op. cit., p. 47.

Failure to adjust to lower rates of growth in electricity sales. During the decade of the 1960's, sales of electricity grew much faster than the gross national product (GNP), stimulated by falling real prices of electricity. By the late 1970's, sales of electricity increased somewhat more slowly than GNP in response to the first real increase in electricity prices.<sup>10</sup> Many utilities had embarked on building programs to accommodate the 7-percent annual growth rate of the 1960's. Many failed to cut back their plans for new generating capacity and wound up at the end of the decade with margins of reserve generating capacity far beyond the 20 percent considered prudent by the industry. Overall, the reserve margin for the entire investor-owned electric utility industry increased from an average of 21 percent in 1973 to 34 percent in 1978.<sup>11</sup>

These averages conceal a wide variation in experience from region to region and from utility to utility within the same region. Sales for some utilities in the Southwest grew 6 and 7 percent per year from 1973 to 1979 while several utilities in the New York/New Jersey region experienced stagnant or declining sales over the same period (see table 71). Growth rates in the price of electricity also differed sharply from utility to utility. The residential electric rate charged by Puget Sound Power & Light increased at 7 percent per year, slower than the general price increase, while prices for Long Island Lighting increased at an average of almost 16 percent per year.

<sup>10</sup>Hyman, op. cit., pp. 40-41.

<sup>11</sup>Hyman, op. cit., p. 43.

**Table 71.—Rate Increases and Demand Growth Over the Past 5 Years for Utilities in Various Urban Areas**

| Utility                             | 1979<br>residential<br>rate<br>(c/kWh) | 1973-1979<br>average annual<br>increase in residential<br>rate (percent) | 1979<br>kWh sales<br>(10 <sup>6</sup> ) | 1973-1979<br>average annual<br>increase in kWh<br>sales (percent) |
|-------------------------------------|--|--|---|---|
| <i>New England:</i>                 |  |  |   |   |
| Boston Edison ...                   | 6.4                                    | 10.2%  | 12,155                                  | 1.2%  |
| New England Electric (H) ...        | 6.0                                    | 11.2   | 16,372                                  | 1.0   |
| Northeast Utilities (H) ...         | 5.2                                    | 9.2  | 20,485                                  | 1.3   |
| Public Service of New Hampshire ... | 5.8                                    | 13.1   | 5,602                                   | 3.5   |
| United Illuminating ...             | 6.2                                    | 14.1   | 4,780                                   | .6  |
| <i>New York/New Jersey:</i>         |  |  |   |   |
| Consolidated Edison ...             | <b>10.5</b>                            | <b>12.5</b>  | <b>29,350</b>                           | <b>- 2.8</b>  |
| Long Island Lighting ...            | 7.2                                    | 15.8   | 13,319                                  | 1.1   |
| Niagara Mohawk Power ...            | 4.4                                    | 9.1  | 32,483                                  | .5  |

**Table 71.—Rate Increases and Demand Growth Over the Past 5 Years for Utilities in Various Urban Areas—Continued**

| Utility   | 1979<br>residential<br>rate<br>(¢/kWh) | 1973-1979<br>average annual<br>increase in residential<br>rate (percent) | 1979<br>kWh sales<br>(10 <sup>6</sup> ) | 1973-1979<br>average annual<br>increase in kWh<br>sales (percent) |
|---|--|--|---|---|
| Orange & Rock Utility . . . . .                     | 8.5                                    | 15.7   | 3,436                                   | .1  |
| Public Service Electric & Gas . . . . .             | 7.0                                    | 12.7   | 29,587                                  | .3  |
| Rochester Gas & Electric . . . . .                  | 4.6                                    | 8.2  | 6,690                                   | -.3   |
| <b>Midatlantic:</b>                                 |  |  |   |   |
| Baltimore Gas & Electric . . . . .                  | 5.0                                    | 8.8  | 16,823                                  | 2.7   |
| Delmarva Power & Light . . . . .                    | 5.9                                    | 10.7   | 7,491                                   | 6.4   |
| General Public Utilities (H) <sup>a</sup> . . . . . | 6.1                                    | 12.8   | 12,770                                  | 3.1   |
| Pennsylvania Power & Light . . . . .                | 4.2                                    | 9.6  | 22,555                                  | 3.0   |
| Philadelphia Electric . . . . .                     | 5.8                                    | 9.2  | 27,559                                  | .8  |
| Potomac Electric Power . . . . .                    | 5.0                                    | 11.4   | 15,676                                  | 1.4   |
| Virginia Electric & Power . . . . .                 | 5.1                                    | 14.2   | 37,575                                  | 3.8   |
| Duquesne Light . . . . .                            | 6.2                                    | 12.8   | 13,575                                  | 1.3   |
| <b>South Atlantic:</b>                              |  |  |   |   |
| Carolina Power & Light . . . . .                    | 4.1                                    | 12.8   | 28,667                                  | 2.9   |
| Duke Power . . . . .                                | 3.9                                    | 10.9   | 50,323                                  | 2.6   |
| Florida Power & Light . . . . .                     | 4.7                                    | 12.7   | 41,965                                  | 4.4   |
| Gulf State Utilities . . . . .                      | 3.9                                    | 8.1  | 29,741                                  | 5.4   |
| Kentucky Utilities . . . . .                        | 3.9                                    | 9.2  | 10,166                                  | 6.0   |
| Louisville Gas & Electric . . . . .                 | 3.7                                    | 10.2   | 7,794                                   | 1.2   |
| Middle South Utility (H) <sup>b</sup> . . . . .     | 3.0                                    | 7.1  | 23,252                                  | 4.4   |
| South Carolina Electric & Gas . . . . .             | 4.7                                    | 12.8   | 11,251                                  | 1.2   |
| Tampa Electric . . . . .                            | 5.2                                    | 14.5   | 10,141                                  | 4.4   |
| <b>Midwest:</b>                                     |  |  |   |   |
| Cincinnati Gas & Electric . . . . .                 | 3.9                                    | 6.9  | 12,190                                  | 3.0   |
| Cleveland Electric & Illuminating . . . . .         | 5.5                                    | 12.7   | 19,030                                  | 1.2   |
| Commonwealth Edison . . . . .                       | 5.1                                    | 9.0  | 64,057                                  | 1.9   |
| Dayton Power & Light . . . . .                      | 4.6                                    | 12.5   | 10,234                                  | 3.3   |
| Detroit Edison . . . . .                            | 5.1                                    | 11.7   | 36,891                                  | .7  |
| Illinois Power . . . . .                            | 4.3                                    | 8.2  | 14,225                                  | 5.0   |
| Northern Indiana Public Service . . . . .           | 5.5                                    | 11.9   | 14,007                                  | 4.0   |
| Northern States . . . . .                           | 4.2                                    | 8.0  | 22,579                                  | 5.3   |
| Minnesota Power & Light . . . . .                   | 5.1                                    | 10.1   | 8,357                                   | 9.5   |
| Ohio Edison . . . . .                               | 5.4                                    | 12.9   | 19,614                                  | 1.8   |
| Toledo Edison . . . . .                             | 5.9                                    | 14.4   | 7,708                                   | 2.6   |
| Wisconsin Electric Power . . . . .                  | 4.4                                    | 9.2  | 17,670                                  | 4.6   |
| <b>Southwest:</b>                                   |  |  |   |   |
| Houston Industries . . . . .                        | 4.1                                    | 13.9   | 52,360                                  | 7.1   |
| Oklahoma Gas & Electric . . . . .                   | 3.6                                    | 8.6  | 19,992                                  | 5.8   |
| Southwestern Public Service . . . . .               | 5.2                                    | 11.6   | 11,378                                  | 5.6   |
| Texas Utilities (H) <sup>c</sup> . . . . .          | 4.1                                    | 10.4   | 24,799                                  | 6.9   |
| <b>Central:</b>                                     |  |  |   |   |
| Kansas City Power & Light . . . . .                 | 5.4                                    | 11.7   | 8,218                                   | 2.5   |
| <b>North Central</b>                                |  |  |   |   |
| Montana Dakota Utilities . . . . .                  | 4.2                                    | 7.6  | 1,500                                   | 2.5   |
| Public Service Colorado . . . . .                   | 4.2                                    | 7.8  | 14,296                                  | 7.7   |
| Utah Power & Light . . . . .                        | 4.3                                    | 11.8   | 15,171                                  | 11.3  |
| <b>West:</b>  |  |  |   |   |
| Arizona Public Service . . . . .                    | 5.6                                    | 13.9   | 11,584                                  | 6.1   |
| Pacific Gas & Electric . . . . .                    | 3.5                                    | 7.5  | 59,815                                  | 1.8   |
| San Diego Gas & Electric . . . . .                  | 5.3                                    | 13.8   | 9,851                                   | 3.9   |
| Southern California Edison . . . . .                | 4.7                                    | 8.3  | 59,518                                  | 1.6   |
| Tuscon Electric Power . . . . .                     | 5.9                                    | 11.6   | 6,244                                   | 9.5   |
| <b>Northwest:</b>                                   |  |  |   |   |
| Pacific Power & Light . . . . .                     | 2.6                                    | 9.5  | 22,843                                  | 4.3   |
| Portland General Electric . . . . .                 | 2.8                                    | 12.9   | 13,652                                  | —   |
| Puget Sound Power & Light . . . . .                 | 2.0                                    | 7.0  | 13,977                                  | 7.0   |

<sup>a</sup>General Public Utilities includes Jersey Central Power & Light and Metro Edison (Reading). Jersey Central Power & Light (the largest of the two) figures are shown here.

<sup>b</sup>Middle South Utility includes Arkansas Power & Light; Arkansas-Missouri Power Co., Crosssett Electric; Louisiana Power & Light, New Orleans Public Service; and Middle South Services Louisiana Power & Light (the largest utility in the holding company) figures are shown here.

<sup>c</sup>Texas Utilities includes Dallas Power & Light; Texas Electric Service Co., Texas Power and Light; Texas Utilities Fuel Co.; Texas Utilities Generating Co., and Texas Utilities Services, Inc. Texas Power and Light (the largest utility in the holding company) figures are shown here.

(H) = Holding company

SOURCE: Electrical World, *Directory of Electric Utilities*, 1974-1975, 83rd edition, 1974, and 1980-1981, 89th edition, 1980.



Reserve margins also differ significantly among the nine Regional Reliability Councils (utilities coordinating power demands). As is clear from table 72, three of the Reliability Councils (West, Mid-Continent and Mid-America) are operating with reserve margins no higher than the prudent 20 percent. Texas, however, has a reserve margin of 36 percent and the Northeast a reserve margin of 37 percent.

Declining relative return on equity, over the decade from 1970, the average percent return on common equity fell from 11.8 to 11.0 percent, further and further behind the average authorized return on equity granted in utility rate decisions.<sup>12</sup>(See table 73.) Actual earned returns on common equity failed to keep up either with inflation or with the increasing interest rates in the bond market. State regulatory commissions, faced with vocal public opposi-

<sup>12</sup>Edison Electric Institute, op. cit., tables 3 and 15.

**Table 72.—Projected Reserve Margins: July 1980 and February 1981 (in percent)**

| Regional Reliability Council  | July 1980 | February 1981    |
|---|-----------|------------------|
| Northeast Power <sup>a</sup> .....                                    | 43%       | 37% <sup>0</sup> |
| Mid-Atlantic Area .....   | 28        | 48               |
| East Central Area .....   | 27        | 35               |
| Southeastern .....  | 27        | 28               |
| Mid-America <sup>a</sup> (Mo., Wis., Ill.) . . .                      | 21        |                  |
| Southwest .....   | 26        | 65               |
| Mid-Continent Area<br>(N. Dak., S. Dak., Minn.,<br>Iowa, Nebr.) ..... | 21        | 51               |
| Texas .....   | 36        | 50               |
| Western Systems <sup>a</sup> .....                                    | 21        | 27               |
| Reserve Margin U.S. ....  | 27        | 37               |

<sup>a</sup>U.S. portion of the pool.

SOURCE: National Electric Reliability Council. Adequacy of Power Supply Winter 1980/81 and Summer 1980.

**Table 73.—Private Utility Return on Equity**

|                       | Average authorized return | Estimated return |
|-----------------------|---------------------------|------------------|
| 1970 .....            | .                         | 11.80/0          |
| 1976 .....            | 12.8%                     | 11.5?40          |
| 1980 (estimate) ..... | 14.20/0                   | 11.00/0          |

SOURCE: Edison Electric Institute. Statement at FERC Conference on the Financial Condition of the Electric Utility Industry in the United States, March 1981, tables 15 and 3.

tion to increases in electricity costs have resisted large rate increases. Even substantial rate increases have proved inadequate for utilities where sales have not grown as rapidly as expected. As inflation got worse, lags in regulatory adjustment of rates undermined rate relief. States differ in the return they are willing to give utilities, in the speed of decision making on rates, and in the accounting rules they use in computing rates. (The Solomon Bros. rating of State utility commissions and a summary of their practices is shown in app. C.)

**Experience of Each Utility is Different.** Utilities differ in the extent to which they have had to cope with the problems described above. Some utilities such as Ohio Edison are experiencing slow growth in demand and generate most of their electricity with coal. Others such as Florida Power & Light must cope with both the price pressures caused by heavy dependence on fuel oil to generate electricity and with the pressure of an annual growth rate in sales of more than 4 percent. Particular utilities faced with angry customers because of rapid increases in electricity rates, stagnant growth in electricity sales or financially threatening capital requirements for new generating capacity may consider developing an energy management program as one response to these problems. The problems and opportunities of such programs for each of these reasons is described below, after the discussion of publicly owned systems.

**Federal Power Marketing Agencies and Publicly Owned Systems**

Public power is much more important in some parts of the country than in others.

Six Federal power marketing agencies (see table 74) own about 9 percent of all the installed generating capacity in the United States. With a total system capacity of almost 30,000 MW, TVA, established in 1933, is the largest of these and the largest single electric utility in the country. About 65 percent of TVA's sales are at wholesale to municipal utilities and rural electric co-ops. The remainder is sold to private industries, other Federal agencies, and private power companies. The Bonneville Power Ad-

**Table 74.—Publicly and Privately Owned Systems Within the U.S. Electric Power System, 1979**

| Type of system                        | Number of systems | Installed capacity |               |
|---------------------------------------|-------------------|--------------------|---------------|
|                                       |                   | Thousand MW        | Percent       |
| Privately-owned . . . . .             | 218               | 446                | 7.9%          |
| Local public systems . . . . .        | 2,206             | 56                 | 1.0           |
| Federal power agencies . . . . .      | 6                 | 52                 | .9            |
| Rural electric cooperatives . . . . . | 916               | 17                 | .3            |
| <b>Total . . . . .</b>                |                   | <b>571</b>         | <b>1000/0</b> |

NOTE: Percent column does not add to 100 due to rounding.  
 SOURCE: "Public Power Directory," *Public Power*, January-February 1981

ministration was created by the Bonneville Project Act of 1937 and markets power from 30 hydroelectric projects constructed by the Army Corps of Engineers and the Bureau of Reclamation constructed in the Columbia River Basin. It also sells power wholesale to publicly owned systems in the Northwest.<sup>13</sup>

The more than 2,000 local publicly owned systems own less than 10 percent of the generating capacity in the country. They include city-owned systems (municipal utilities), county-owned systems and a few State-owned systems such as the Power Authority of the State of New York (PASNY) which operates more than 9,000 MW of capacity for resale to municipalities, private utilities and industrial customers in New York and neighboring States.

About 44 cities with more than 50,000 population own their own electric utilities (see table 75). Many of these purchase power from the TVA (Memphis, Nashville, Knoxville) and others from the Bonneville Power Administration (Seattle, Tacoma). There are several large municipal utilities in Texas (San Antonio, Austin), in Florida (Gainesville, Jacksonville), and in California (Los Angeles, Palo Alto, Santa Clara County). In all fewer than 100 municipal utilities experience more than 100 MW in peak demand. The number of municipal utilities has remained stable over the last two decades. Recent

<sup>13</sup>This section is drawn from background information on publicly owned utilities in the forthcoming OTA report on *Cogeneration*.

efforts to establish publicly owned systems in Oregon and New York State have been vigorously opposed by private utilities, and generally defeated. One small city, Messina, in upstate New York has succeeded in establishing a municipal utility after protracted legal battles.

Both Federal power systems and municipal utilities (as well as State and county-owned systems) have some advantages over privately owned utilities. As public entities they do not pay taxes and they raise money in the tax-free bond market. Thus their financing costs are significantly less than the costs of private systems. TVA is projecting 9.5-percent interest rates on its bonds for the 1980's compared to new private utility bond interest rates of 14 percent.<sup>14</sup> Federal power marketing systems set their own rates. The rates of municipal systems are approved by the local city government. State public utility commissions have no jurisdiction over municipal utility sales within city limits. In some cities such as Seattle, Wash., the local city government exerts considerable control over the public utility. More commonly, the municipal utility operates fairly independently of the city government. San Antonio's municipal utility has an independent board appointed to serve the interests of the holders of the debentures issued for the original capital of the system. The mayor of San Antonio meets with the Board ex-officio and the rates are approved by the city council.<sup>15</sup>

publicly owned systems have had to deal with many of the problems confronted by privately owned systems in the 1970's; increasing cost of new generating capacity, increasing interest rates, and customers angry at rate increases. A few public systems have responded with energetic conservation programs; TVA (described in box N) and Seattle City Light. Others have stuck to more traditional responses of adjusting and managing traditional powerplant construction programs.

<sup>14</sup>Sansom, op. cit., and Edison Electric Institute, op. cit.  
<sup>15</sup>See description in the San Antonio Case Study in ch.10.

Table 75.—Municipal Utility Systems Serving Cities With Populations Over 50,000

| Municipal utility  | 1978 peak demand (kW) | Municipal utility                                 | 1978 peak demand (kW) |
|--|-----------------------|---|-----------------------|
| <i>Alabama</i>   |                       | <i>Louisiana</i>                                  |                       |
| Huntsville Utilities . . . . .                               | 525,000               | Lafayette Utilities System . . . . .              | 187,000               |
| <i>Arkansas</i>  |                       | Monroe Utility Commission . . . . .               | —                     |
| North Little Rock Electric . . . . .                         | 156,942               | <i>Michigan</i>                                   |                       |
| <i>California</i>  |                       | Detroit Public Lighting . . . . .                 | 115,000               |
| Anaheim Electric . . . . .                                   | 388,800               | Lansing Board of Water and Light . . . . .        | 391,000               |
| Burbank Public Service . . . . .                             | 197,000               | <i>Minnesota</i>                                  |                       |
| Glendale Public Service . . . . .                            | 194,500               | Rochester Public Utility . . . . .                | 112,600               |
| Hetch Hetchy Water and Power<br>(San Francisco) . . . . .    | 456,000               | <i>Missouri</i>                                   |                       |
| Los Angeles Department of Water<br>and Power . . . . .       | —                     | Columbia Water and Light . . . . .                | 114,000               |
| Palo Alto Electric . . . . .                                 | 143,793               | Independence Water and Light . . . . .            | 187,700               |
| Pasadena Water and Power . . . . .                           | 175,000               | Springfield Cities Utilities . . . . .            | 338,000               |
| Riverside Public Utility . . . . .                           | 277,920               | <i>Nebraska</i>                                   |                       |
| Sacramento Municipal Utility . . . . .                       | 1,577,785             | Lincoln Electric System . . . . .                 | 369,057               |
| Santa Clara Electric . . . . .                               | 193,872               | <i>North Carolina</i>                             |                       |
| <i>Colorado</i>  |                       | Fayetteville Public Works . . . . .               | 263,200               |
| Colorado Springs Department of Public<br>Utilities . . . . . | 294,000               | <i>Ohio</i>                                       |                       |
| <i>Florida</i>   |                       | Cleveland Division of Light and Power . . . . .   | 105,000               |
| Gainesville-Alachua Co. Regional<br>Electric . . . . .       | 179,400               | <i>Oregon</i>                                     |                       |
| Jacksonville Electric . . . . .                              | 1,253,000             | Eugene Water and Electric . . . . .               | 482,600               |
| Orlando Utility . . . . .                                    | 459,000               | <i>Tennessee</i>                                  |                       |
| Tallahassee Electric Department . . . . .                    | 256,000               | Chattanooga Electric Power Board . . . . .        | —                     |
| <i>Georgia</i>   |                       | Clarksville Department of Electricity . . . . .   | 140,220               |
| Albany Water, Gas and Light . . . . .                        | 140,255               | Knoxville Utilities Board . . . . .               | 1,011,571             |
| <i>Illinois</i>  |                       | Memphis Light, Gas and Water . . . . .            | 2,074,342             |
| Springfield Water, Light and Power . . . . .                 | 310,000               | Nashville Electric Service . . . . .              | 1,612,132             |
| <i>Indiana</i>   |                       | <i>Texas</i>                                      |                       |
| Anderson Municipal Light and Power . . . . .                 | 106,800               | Austin Electric Department . . . . .              | 763,000               |
| <i>Kansas</i>  |                       | Garland Electric Department . . . . .             | 285,000               |
| Kansas City Board of Public Utilities . . . . .              | 428,400               | Lubbock Power and Light . . . . .                 | 135,500               |
| <i>Kentucky</i>  |                       | San Antonio Public Service . . . . .              | 1,688,000             |
| Owensboro Municipal Utility . . . . .                        | 129,600               | <i>Washington</i>                                 |                       |
|  |                       | Seattle Department of Lighting . . . . .          | 1,644,000             |
|  |                       | Tacoma Public Utilities, Light Division . . . . . | 825,573               |

SOURCES: Electrical World, *Directory of Electric Utilities, 1979-1980*, McGraw Hill, Inc., 1979; Electrical World, *Electric Utilities of the United States* (map), McGraw Hill, Inc., 1977; U.S. Department of Commerce, Bureau of Census, *County and City Data Book, A Statistical Abstract Supplement, 1977* (Washington, D. C.: U.S. Government Printing Office, 1978).

### Box N.—TVA Home Insulation Program—Audits and Finances to Reduce Demand

In 1977, TVA launched a major program—called the Home Insulation Program (HIP)—to provide free audits, interest-free loans, and follow-up evaluation to residential customers throughout the system. The program was developed to reduce present and future demand for electricity by encouraging more efficient use. TVA set a goal of fully weatherizing 145,000 homes by 1986. As of the fall of 1981, it had completed 490,000 audits and made 210,000 loans.<sup>1</sup>

The basic HIP approach has three components:

1. All residential customers, regardless of the type of fuel used are eligible for a free home energy survey.
2. Customers in electrically heated or cooled homes are eligible for an interest-free loan that covers material and labor costs, up to \$2,000, for weatherization.
3. When work is completed, TVA reinspects the retrofit to ensure that it conforms to TVA specifications. Payment is not made until TVA certifies that the work conforms to utility standards.

The goal of the HIP is to yield an annual energy savings of 2.5 billion kwh and to save about 1,100 MW of peak electric demand by 1990, at a total estimated program cost of \$126 million.<sup>2</sup> TVA's 2.5 million residential customers (served by 160 distributors) account for 33 percent of the system's output. Forty-five percent of the system's residential customers use electric space heat.

According to an evaluation performed for TVA in the spring of 1980 by ICF Inc., HIP had already substantially benefited both customers and management. ICF found that the average \$310 investment made by participants was recovered within 4 years in reduced utility bills.<sup>3</sup> ICF estimated that the program had had a substantial cumulative effect on the demand for TVA power. According to the evaluation, the first 27,000 participants would realize combined annual energy savings of 50.5 million kWh, or a total of 758 million kWh over a useful insulation life of 15 years.<sup>4</sup>

Although other utilities offer audits with financing, TVA has an unusual combination of aggressive marketing, interest-free financing, and quality control through reinspection of retrofit work. By September 1981, audits under HIP had been conducted of almost 20 percent of the 2.5 million consumers in the TVA service area.

At first TVA had trouble reaching low-income households. In October 1980, TVA officials reported that only 5.2 percent of the participants in the HIP came from households with incomes of less than \$5,000 even though these were more than 20 percent of the customer households. By the fall of 1981, TVA had made notable progress. Nearly 40 percent of all households participating in the program were low income. TVA also had some initial difficulty reaching renters which in 1980 were less than 7 percent of all households surveyed. TVA officials launched a concentrated campaign to persuade landlords to have their buildings surveyed and retrofit. The effort met with some success. As of September 1981, 84,500 rental units had been surveyed. TVA has provided window stickers to those apartment owners who implement the suggested weatherization measures.<sup>5</sup>

TVA also launched two other specific programs designed to assist low-income households. One of these is the Warm Room Project which will allow customers to finance insulation for one room or area of their homes which they will use most during the winter months. In a second project to benefit low-income people, TVA has set a goal of weatherizing all of an estimated 30,000 electrically heated public housing units in its service area within 2 years. In cases when weatherization funds are not available to public housing authorities, TVA's no-interest loans will be used. As of September 1981, 33,199 units had been surveyed and 2,039 insulated.<sup>6</sup>

While HIP is the most prominent component of the TVA program it is not the only one. The utility also offers lo-year loans for heat pumps at a moderate interest rate pegged at TVA's average cost of borrowing (14 percent in 1981). TVA estimates that in the average home a heat pump could save 4,000 to 7,000 kWh a season or \$180 to \$322 a year. The number of homes reached by the program is impressive. As of September 1981, TVA had made about 24,500 heat pump recommendations and 12,200 installations, and had loaned about \$40 million. Under a similar program to finance solar hot water heaters, 8,400 surveys had been conducted and almost 2,000 systems installed.<sup>7</sup>

TVA has also extended its audit and financing approach to the approximately 300,000 commercial and industrial customers served by its distributors. A walk-through survey is available at no charge for customers whose facilities can be analyzed in approximately an 8-hour period. TVA will also reimburse the cost of a more extensive and complex survey if the customer implements electricity-saving measures which achieve 75 percent of the estimated dollar savings possible. As of September 1981, about 6,000 commercial and industrial buildings had been surveyed. TVA will also make loans for up to 10 years at its average borrowing rate of 14 percent, but as of September 1981, less than 40 customers had obtained these loans.<sup>8</sup>

<sup>2</sup>Tennessee Valley Authority Office of Power, Division of Energy Conservation and Rates, Program Summary, October 1981.

<sup>3</sup>TVA, op. cit., p. 1.

<sup>4</sup>ICF, Inc., *The TVA Home Insulation Program: An Evaluation of Early Program Impact*, April 1980, pp. vi-vii.

<sup>5</sup>ICF, op. cit., p. vii.

<sup>6</sup>Robert F. Hemphill and Ronald L. Ownens, "Burden Allocation and Electric Utility Rate Structures: Issues and Options in the TVA Region," unpublished paper, October 1980, p. 6; Deborah R. Both, Robert Dubinsky, and Sue Bodilly, *A Description of Integrated Retrofit Delivery Systems and Innovative Conservation Programs in Selected Localities*, The Rand Corp., March 1981 (N-1673-DOE); TVA, op. cit., pp. 1-2, 8.

<sup>7</sup>TVA, op. cit., pp. 7-8.

<sup>8</sup>WA, op. cit., pp. 4-5, 17-18.

<sup>9</sup>TVA, op. cit., pp. 12-13.

## VARIETIES OF ENERGY CONSERVATION PROGRAMS

The following sections in the chapter describe the characteristics of energy management programs undertaken for any of four reasons:

- improve customer relations;
- earn profits in unregulated subsidiaries;
- earn profits for gas companies within a regulated framework; and
- permit postponing of electric generating plant construction.

### Energy Conservation Programs Primarily for Public Relations Purposes in Gas and Electric Utilities

Many gas and electric companies have developed low-volume audit programs in the last few years. A few have developed high-volume programs for more than public relations value, as discussed below. The Tampa Electric Co. developed an energy audit program in September 1978. **The purpose of the program was partly to gain experience with a program before being required to have one by the Federal Government and partly to promote good relations with utility customers. Only if, in the very long term, a conservation ethic developed among its customers, did Tampa Electric expect the audit program to have an impact on the utility's demand** for electricity.<sup>16</sup> Northern States Power launched a similar program in 1976 to help its gas customers cope with skyrocketing gas costs. In all about 65 investor-owned utilities had audit programs as of the winter of 1977-78 before the Federal utility audit program (RCS) was announced.<sup>17</sup>

Of these most are low-volume programs which are not explicitly tied to major reductions in requirements for generating capacity although the utility may express an expectation that the program will affect growth in peak demand over the long run. The resources devoted to these programs are limited (compared to

<sup>16</sup>*Electric and Gas Utility Marketing of Residential Energy Conservation: Case Studies*, May 1980, Booz Allen for the Department of Energy.

<sup>17</sup>Unpublished survey data compiled by staff of Residential Conservation Office, DOE, September 1981.

large-volume programs discussed below) and the numbers of audits performed each year is also fairly small, not likely to have a major impact on building retrofit. Table 76 shows four moderate-volume audit programs assessed for a DOE study. The largest volume program of the four—Niagara Mohawk—had done about 3,300 audits in a single year. Such programs do not market as aggressively to prospective customers as a more goal-oriented program might. Virtually all such programs offer audits primarily to single family residential customers.

### Energy Conservation Programs Launched by Utilities To Earn Money as Unregulated Subsidiaries

Reduced earnings and projections of slow growth or decline in the demand for electricity and gas have led some gas and electric utilities to consider diversifying into aspects of the energy conservation business in order to have an entry into an enterprise with a potential for growth.

Electric utilities and gas distribution companies have been diversifying into other businesses over the past few years. The desire on the part of utility executives to put capital to work in less regulated businesses (as well as assure a secure supply of fuel) has led to significant investment in such areas as oil and gas exploration and coal mining. Many of the companies have created holding companies with new names and new subsidiaries to pursue these interests.

Several companies (Boston Gas and Washington Natural Gas, among others) have recently attempted to market energy-efficient appliances or conservation devices. These efforts have met with mixed results. There are several major problems that utilities face when trying to enter these markets:

- They do not have distribution channels outside their service areas and therefore cannot gain some of the benefits of economies of scale that their competitors have.

**Table 76.—Audits per Year Performed by Selected Utilities**

|  | Audits per year  | Audit staff   | Financing   |
|--|--|---|---|
| <b>Utilities with moderate volume audit programs<br/>(time period covered)</b> |  |   |   |
| Arizona Public Service<br>(summer 1977-December 1978) . . . . .                | About 1,800  | 11  |   |
| Niagara Mohawk<br>(June 1978-summer 1979) . . . . .                            | About 3,300 onsite   | <b>50</b>   | 9.5 percent                                       |
| Northern States Power<br>(December 1977 -July 1979) . . . . .                  | About 3,000  | <b>5</b>  | Available to<br>some<br>customers at<br>9 percent |
| Tampa Electric Co.<br>(September 1978-October 1979) . . . . .                  | About 2,000  | <b>4</b>  | None  |
| <b>Utilities with large volume audit programs<br/>(time period covered)</b>    |  |   |   |
| Public Service Colorado . . . . .  | 35,000 attics insulated<br>4,500 audits (in 6<br>months)     | 20 full time;<br>50 equivalent;<br>100 auditors,<br>part-time                                 |   |
| Pacific Power & Light<br>(October 1978-summer 1979) . . . . .                  | <b>11,000</b>  | 150 auditors;<br>15 post<br>installation<br>inspectors<br>60-70 per-<br>cent of their<br>time | 10,000 zero<br>interest loans                     |
| Pacific Gas & Electric<br>Attic insulation program (1978) . . . . .            | <b>4,922</b> attic inspections;<br>4,500 attic installations | 135 (75 of these<br>are energy<br>auditors)   |   |
| Audit Program<br>(January-September 1979) . . . . .                            | <b>20,000</b>  |   | 5,422<br>6 percent low<br>interest loans          |
| <b>NEESPLANS goals 1982 and beyond</b>   |  |   |   |
| Residential . . . . .  | 16,000 for 5 years   | 37  |   |
| Commercial . . . . .   | <b>9,000</b>   | 42  |   |
| Industrial . . . . .   | <b>1,750</b>   | 21  |   |

SOURCES: May 1980 report by Booz Allen Hamilton, prepared for DOE under contract No. ET-78-C-01-3356, *Electric and Gas Utility Marketing of Residential Energy Conservation*; NEESPLAN, New England Electric System, October 1979; and the Office of Technology Assessment.

- Their lack of marketing expertise cannot be overcome simply by hiring a manager from a marketing-oriented firm. The entire utility management needs to become marketing oriented.
- Unless they can contribute something of value to the product (lower cost of production, improved performance, or economies of distribution) they cannot compete effectively with the other manufacturers.

For example, Boston Gas Co. recently attempted to market a water temperature thermostat to its customers. Their sales volume never exceeded 5,000 units per year in a service territory of over 200,000 customers. They sold the product to a private firm that is now selling about 2,500 units per month.<sup>18</sup>

<sup>18</sup> Interview for OTA by Temple Barker Sloane, Inc., with president of Boston Gas Co.

Utilities may eventually become successful at marketing conservation equipment, but a new management orientation, special technical and marketing expertise, and broader distribution channels will be required. In a survey conducted by Booz Allen & Hamilton for the Edison Electric Institute only 4 out of 24 electric and combined gas and electric utilities identified profit potential in energy management ventures. Most utility executives interviewed viewed the residential energy management sector as highly competitive. Certain advanced conservation technologies and solar devices have growth potential as businesses but are still considered to pose significant business risk—of poor customer acceptance, poor reliability and/or unstable sales costs. Some of these same utility executives believed that “energy ventures targeted at the industrial sector . . . may offer

more attractive profit opportunities than residential market programs.”<sup>19</sup>

Although most executives interviewed felt that the most important factor is the strategic fit of energy ventures with existing utility expertise, they did cite other potential obstacles to developing such programs.

Protecting returns from regulation. The risks are still significant enough in energy management business ventures that utilities are willing to enter them only if they can earn more than the 11 to 12 percent regulated return. This can be done under any of a number of legal frameworks: an unregulated subsidiary, an unregulated affiliate or a joint venture with another company. In some States, however, utilities are faced with the possibility that utility regulatory commissions will take into account the unregulated profits in determining cost allocations or rate of return on the regulated activities.<sup>20</sup>

Antitrust. Many utilities expect smaller installers and competitors in the energy management business to claim unfair competition from utilities because of the utilities’ opportunity to subsidize its energy management operations from its other operations.<sup>21</sup> (See later discussion of this point from the perspective of competing businesses.)

The utilities’ access to its service mailing lists, service network, and reputation for reliability may also be cited as unfair advantages resulting from its monopoly franchise. In order to avoid some of these issues some utilities reported to Booz Allen that they plan to avoid the use of their customer mailing lists and to encourage a host of competitors in the marketplace.

Public Utility Holding Company Act. This act (passed in 1935 to prevent pyramiding of holding companies involving utilities) requires that the Securities and Exchange Commission approve all investments by utility holding companies in businesses not directly related to the sale of electricity. There are 12 electric utility hold-

ing companies that are subject to the act because they own more than 10 percent of a public utility company. Companies that operate intrastate are exempted from the act. Some companies that are not currently classified as holding companies are concerned that they may be so classified if they make investments outside of the narrow definition of their business.

### Gas Utility Company Profits From Energy Conservation Programs

Gas distribution companies buy gas on contract from pipelines and occasionally from liquefied natural gas (LNG) shipping companies. They may own and operate small natural gas wells in their areas, as does People’s Gas of western New York, but on the whole the only capital assets they must invest in are gas distribution systems. Unlike electric utilities, they have no reason or opportunity to compare “investment” in energy conservation with investment in other capital plant.

While gas distribution companies may have strong motivation to develop energy conservation programs for public relations purposes or in order to earn profits in an unregulated subsidiary (as described above), it is not so clear what incentive gas distribution companies have to earn money from conservation within a regulation framework.

Gas utility executives are primarily concerned about the continued availability of their product. Although short-term supplies of natural gas are generally considered adequate, there is widespread disagreement about the long-term outlook. The United States has consumed natural gas at a rate of about 20 trillion ft<sup>3</sup> (Tcf) per year over the past 5 years. Its existing domestic supply is estimated at 200 Tcf. Supplies have only grown at an annual rate of about 10 Tcf in recent years (see fig. 54). However, drilling and exploration efforts are up dramatically. Hughes Tool Co. predicts that in 1980 about 60,000 wells will be completed, about double the number completed in 1973.<sup>22</sup> As a result, additions to supply in 1980 are expected to reach 15 Tcf.

<sup>19</sup>The source for this whole section is Booz Allen, *Investor-Owned Utility Business Prospects and Problems* in *Energy Management*, progress report to the Edison Electric Institute, Nov. 5, 1980.

<sup>20</sup>Booz Allen, op. cit., p. 22ff.

<sup>21</sup>Booz Allen, op. cit., p. 23 ff.

<sup>22</sup>*Oil and Gas Journal*, Jan. 18, 1980.

Figure 54.—Trends in U.S. Natural Gas Supplies

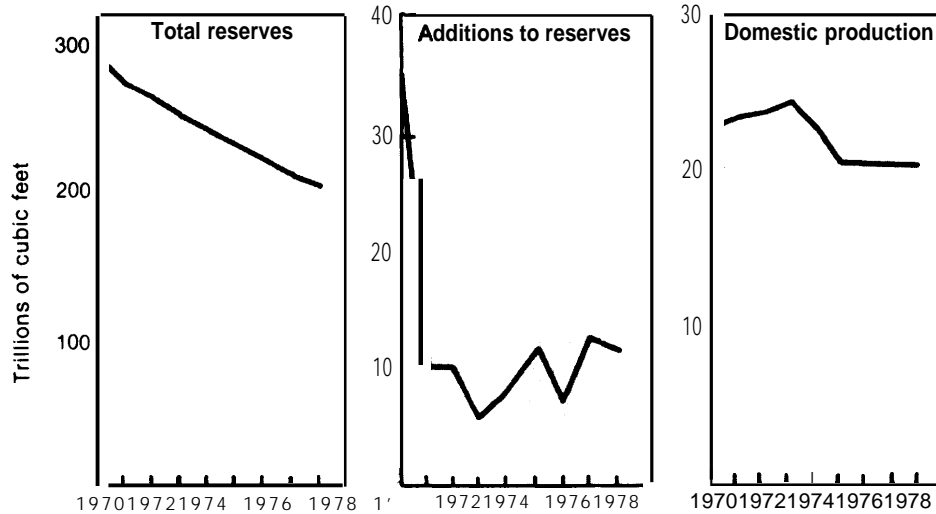

SOURCE: Energy Information Administration, *Annual Report to Congress 1979*, VOL 11, 1979, tables 16 and 37

industry optimists expect these wells and supplies from Mexico, Alaska, and Canada will be supplemented by synthetic gas, liquefied natural gas from Algeria and Indonesia, and gas from tight sand formations. Industry pessimists are concerned that the current gas bubble has been created by a temporary decline in demand, particularly by industrial users, and that new forms of gas supply may not be sufficient to meet increased demand in the 1980's. Conservation by their customers, however, can leave gas companies with additional gas supplies. In theory, gas distribution companies with supplies in excess of customer demands have the opportunity to sell that gas to other gas distribution companies for resale. Currently, in some companies, the price of this gas is pegged to the price of low sulfur residual fuel oil, or the equivalent of about \$5/Mcf. This is generally a higher price than the marginal gas that would be displaced by conservation. Conservation by existing customers would increase the amount of gas available for sale in the markets. As long as the price exceeds the prices of the last block of gas conserved, conservation will remain profitable.

For some gas companies, the hookup of new residential customers to existing distribution lines can be profitable. The hookup of new customers allows the utility to sell gas that would have been sold under the last block of a declin-

ing block structure to new customers at a higher price. One gas company estimates that they earn a \$260 per year return on a fuel oil-to-gas furnace conversion that costs \$125, for an approximate 200-percent return on investment.<sup>23</sup> For such resale to be profitable, however, gas conservation must be by those large users paying the lowest block rates, generally industrial and large commercial customers.

There is another variation of this method of making money off conservation, in gas utilities with "lifeline" rates. These are low rates allowed to residential customers for the first block of gas they consume. Subsequent gas consumption is paid for at increasingly higher rates. In theory, gas companies could encourage conservation among customers using less than their lifeline block and sell this gas to industrial or other large customers paying the highest rate.

None of these three ways of making money off conservation within a regulated framework is very profitable. Given the longer range uncertainty of gas supplies, none provides the basis for a solid multiyear program for a gas utility company. No companies have announced programs to earn (or save) money on this basis. At best these sources of profit could be fortunate

<sup>23</sup> Interview for OTA by Temple Barker Sloane Co. with gas company executive.



byproducts of energy **conservation programs launched** for other reasons, improving customer relations or compliance with a State regulatory order.

### Electric Utility Conservation Programs To Permit Postponement or Curtailment of Plans To Build New Generating Capacity

Many electric utilities express the hope that their low-level energy conservation programs will contribute to slower growth in electricity demand, particularly demand for peak capacity. A few utilities, however, have announced explicit plans to launch ambitious conservation programs and tied these to explicit reductions in the need for new generating capacity.

The New England Electric System (NEES), for example, announced in its NEESPLAN of October 1979 a conservation program for commercial and residential customers to save **300 MW of** peak demand and several different time-of-day pricing and load management programs to save another 500 MW of winter and summer peak demand.<sup>24</sup> This plan would allow NEES to meet its projected 1995 demand almost completely with the powerplants under construction or firmly committed through 1987, as shown in figure 55. Continued growth in demand, without aggressive conservation and load management would require almost 1,000 MW more capacity in 1995. NEES expects to spend about \$100 million in capital costs (constant 1979 dollars) and about \$10 million additional operating costs to carry out the load management and conservation program.<sup>25</sup>

If successful in reducing its generating requirements, the company expects to save about **\$255 million in capital** costs for new generating capacity.<sup>26</sup> The load management program is not expected to result in loss of electricity sales

<sup>24</sup>NEESPLAN, October 1979, New England Electric System, p.p. 8 and 9. Because of reserve requirements these reductions in peak demand translate into reductions in peak capacity of 350 and 600 MW respectively.

<sup>25</sup>1 bid., pp. 18-19.

<sup>26</sup>The full capital cost savings are higher but they are adjusted downward for higher fuel costs resulting from rising oil generating plants rather than new coal or nuclear plants.

Figure 55.—NEESPLAN Projections of Demand and Generating Capacity Requirements, 1981-95

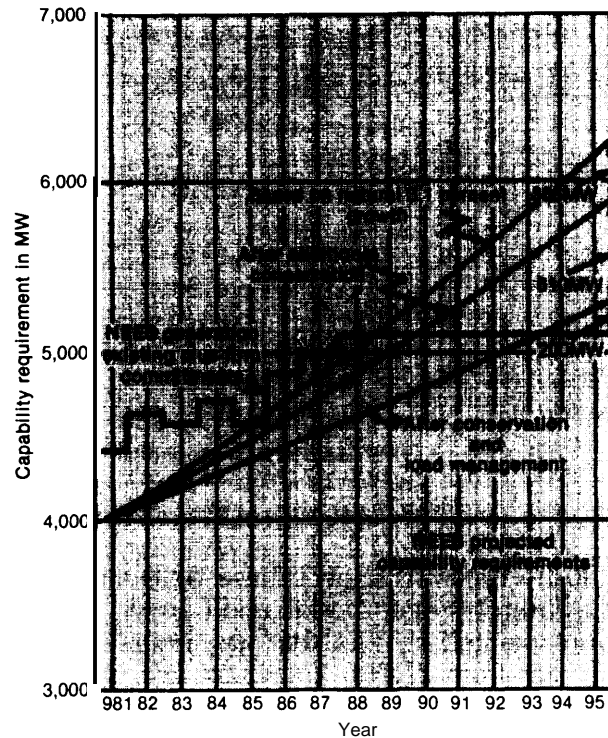

SOURCE: NEESPLAN, New England Electric System, October 1979.

and revenues; rather it is intended to shift more electric demand offpeak and therefore increase the capacity utilization ratio,

Other companies may follow the lead of NEES. Indeed, General Public Utilities following the bleak prospects for raising new capital in the wake of the Three Mile Island accident, announced such a plan. Pacific Power & Light and several California utilities have large volume programs described in table 76. The challenge and difficulty of launching such a program, however, must not be underestimated.

The program must be big enough to permit the postponement or cancellation of all or most of a powerplant. Figure 55 from NEESPLAN illustrates the contrast between the stepwise planning for powerplant construction and the gradual increase in electricity demand. Since powerplants must be planned 7 to 10 years before they are needed, only a significant change in demand can be counted on that far in

advance. Conservation and load management must together provide at least 100 to 300 MW of reduction in capacity before they are big enough to be explicitly taken into account in planning for new capacity.

The planning for conservation and load management must take into account the specific contribution of different devices to reduction in peak demand. Table 77 lists several devices including some of those proposed for the NEES program (such as radio and ripple control and

storage water heaters.) Some, such as those affecting hot water heating, can be expected to reduce the daily peak wherever it occurs, summer or winter. Some, such as the storage space heater (which uses offpeak electricity to heat a tank of hot water which then provides space heat during daytime on peak hours) reduce the winter peak (see NEESPLAN/Load Profile in fig. 56). Neither solar water heating or solar space heating can be relied on to reduce peak demand (if they have electric backup) because a long period of heavy clouds could cause build-

**Table 77.—Potential Impact on Capacity Requirements and Electric Demand of Different Conservation Programs**

| Energy management program ?  | Utility of control | Estimated number of installations for 100 MW reduction in peak demand | Impact on energy consumption per installation   | Cost per installation                           |
|--|--------------------|---|---|---|
| <b>Measures to reduce daily peaks</b>  |                    |   |   |   |
| Storage water heater . . . . .   | No                 | 80-1 20,000 <sup>d</sup>  | Small increase                                  | \$975 for 150 <sup>g</sup> gallon tank          |
| Interlock (prevents water heater, stove, clothes dryer and refrigerator from operating simultaneously) . . . . . | No                 | 59,000 <sup>f</sup>   | Minimal   | <b>\$90-125<sup>n</sup></b>                     |
| Water heater time switch . . . . .   | Yes                | 91,000 <sup>e</sup>   | Minimal   | <b>\$130-240<sup>ij</sup></b>                   |
| Radio and ripple control (cycles water heater, air conditioner) . . . . .  | Yes                | 71,000 <sup>a</sup><br>(water heaters)                                | Minimal   | Radio 95-\$1089<br>Ripple \$100-115h            |
|  |                    | (air conditioners)  |   |   |
| <b>Measures to reduce winter peak</b>  |                    |   |   |   |
| Storage space heater . . . . .   | No                 | <b>7-100,000<sup>a</sup></b>  | Small increase                                  | \$1,000-5,000 <sup>1,m</sup>                    |
| <b>Measures to reduce summer peak</b>  |                    |   |   |   |
| Heat pump hot water heater . . . . .   | No                 | Not estimated   | 50-75 percent reduction in water heating energy | \$400 -800 <sup>o</sup> for single-family house |
| Heat recovery from air-conditioners. . . . .   | No                 | Not estimated   | Substantial reduction (not estimated)           | \$400 -800 <sup>o</sup> for single-family house |
| <b>Measures to reduce energy consumption with uncertain impact on peak</b>                                       |                    |   |   |   |
| Solar water heating . . . . .  | No                 | No systematic impact  | 25-50 percent reduction in water heating energy | \$1,500-3,2000                                  |
| Solar space heating . . . . .  | No                 | No systematic impact  | 25-50 percent reduction in space heating energy | \$4,800 <sup>p</sup>                            |

a John Schaefer, *Equipment for Load Management*, 1979. Based on experience of Detroit Edison and Buckeye Power.  
 b Schaefer Based on experience of Arkansas Power & Light, Mississippi power & Light, and Cobb EMC.  
 c Schaefer, Based on experiences of Kentucky Utilities (upper element functioning at all times).  
 d Argonne National Laboratory, *Assessment of Energy Storage Technologies and Systems*, 1976. Based on computer simulation.  
 e Argonne National Laboratory.  
 f Schaefer, Based on Ohio Edison's experience with interlocks.  
 g Schaefer. Based on 40,000 end-points.  
 h Based on interview with manufacturer.  
 i Schaefer. Based on experiences at Kentucky Utilities.  
 j General Electric Timeswitch Meter Prices.  
 k Based on interview with manufacturer. Does not include installation.  
 l Argonne National Laboratory Central furnace.  
 m Argonne National Laboratory. Baseboard system.  
 n Based on interview with manufacturer.  
 o U.S. Department of Housing and Urban Development, *Hot Water from the Sun*, 1980.  
 p Arthur D. Little, *System Definition Study* - phase 1, 1977. Costs included 200 tt<sup>2</sup> collector, water heater, solar subsystem, and auxiliary resistance heater.  
 q Arthur D. Little, *Assessment Of the Potential for Heat Recovery and Load Leveling on Refrigeration Systems*, 1980.

Figure 56.—NEESPLAN Projected Load Profile, 1980-95

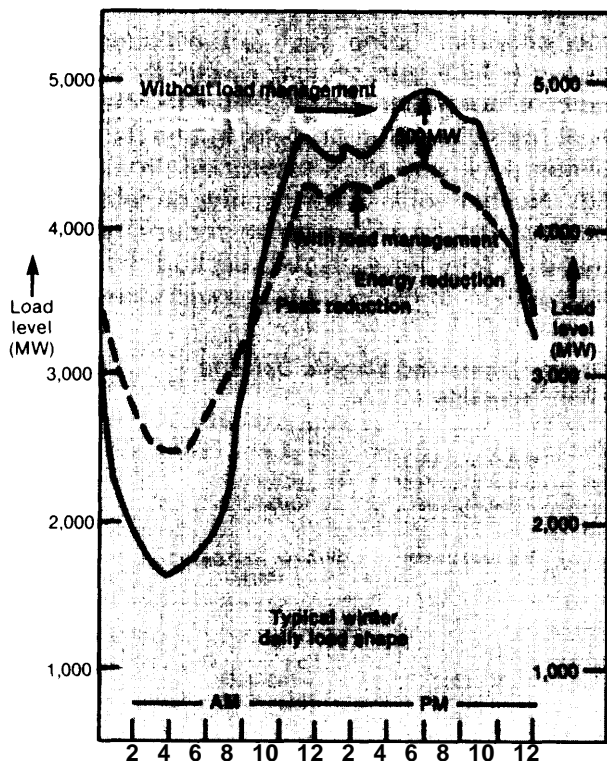

SOURCE: NEESPLAN, New England Electric System, October 1979.

ings equipped with solar heaters to place full demands on the electric system.

It takes thousands of installations on customers' properties to equal a single small powerplant. Table 77 reports on estimates of the number of installations of various conservation and load management devices to equal a 100-MW reduction: 80,000 to 120,000 storage water heaters, 93,000 radio or ripple controls on air-conditioners, NEESPLAN calls for a total of 173,000 audits over the 10-year life of its conservation program, and 350,000 installations of time-of-use meters and radio/ripple receivers for its load management program.<sup>27</sup> The utility must establish entirely new relationships with thousands of customers. This not only requires money and manpower (NEES projects requirements for full-time audit staff of 100) but it requires the ability to convince thousands of customers that **such** a move is in their best interests.

<sup>27</sup>NEESPLAN, op. cit., p. 19.

For several of the NEESPLAN load management devices, customer acceptance will only be forthcoming if NEES and the regulatory commissions in the three States—Massachusetts, Rhode Island, and New Hampshire—require time-of-use rates so that the customer will be penalized for using onpeak electricity.

Measured data is scanty on actual electricity demand with these devices. For this reason, NEESPLAN includes several years of installing and monitoring pilot versions of each program. NEES has some time to do this. It will not have to start planning additional powerplants until 1984 or 1985. By that time, it should be clear if customers will accept the conservation program and load management devices and what the actual impact will be on peak electricity demand and on kilowatt hours.

**Incentives to Other Utilities.** Many other utilities whose characteristics are **shown** in table 78 might have reason to launch ambitious conservation programs. Some have very tight reserve margins; some have large shares of residential customers and winter peaks; some have large shares of commercial customers who might be willing to install load management devices. It is clear from the description of NEESPLAN, however, that entering such uncharted territory with such demanding requirements for success with large numbers of customers may, at this stage, prove a management challenge far greater than the construction of a single small powerplant which such programs would replace.

### Consumer Perspective on Utility Conservation Programs

**As** utilities have begun to launch substantial conservation programs, there have been challenges to utilities from consumer groups concerned that ratepayers will end up paying for conservation programs from which conservation clients will benefit far more than ratepayers. One such group in California, called Toward Utility Rate Normalization (TURN), challenged Pacific Gas & Electric's Zero interest Program (ZIP) conservation financing program on the grounds that it represented a subsidy of rate payers to participants. Participants in

Table 78.—Utility Characteristics That May Influence the Development of Conservation Programs

| Region and name of utility                  | Electric and gas company | Oil and/or gas more than 40 percent of generating capacity (percent) | Planned capacity additions > 70 percent of existing capacity (percent) | Electricity > 40 percent of residential energy use in area<br>W = winter peak (percent) | Commercial electricity > 30 percent of total load (percent) |
|---|--------------------------|--|--|---|---|
| <b>I. New England</b>                       |                          |  |  |   |   |
| Boston Edison . . . . .                     | —                        | 780/o  | —  | —   | 380/o   |
| New England Electric (H) . . . . .          | —                        | 58   | N/A  | (w)   | N/A   |
| Northeast Utilities (H) . . . . .           | X                        | 45   | N/A  | (w)   | —   |
| Public Service of New Hampshire . . . . .   | —                        | —  | 1840/o   | —   | —   |
| United Illuminating . . . . .               | —                        | 93   | —  | —   | —   |
| <b>II. New York/New Jersey</b>              |                          |  |  |   |   |
| Consolidated Edison . . . . .               | X                        | 67   | —  | —   | 57  |
| Long Island Lighting . . . . .              | X                        | N/A  | 81   | —   | —   |
| Niagara Mohawk Power . . . . .              | X                        | N/A  | 98   | (w)   | —   |
| Orange & Rock Utility . . . . .             | X                        | 95   | —  | —   | —   |
| Public Service Electric & Gas . . . . .     | X                        | —  | —  | —   | 35  |
| Rochester Gas and Electric . . . . .        | X                        | —  | 113  | (w)   | —   |
| <b>III. Midatlantic</b>                     |                          |  |  |   |   |
| Baltimore Gas & Electric . . . . .          | X                        | —  | —  | (w)   | —   |
| Delmarva Power & Light . . . . .            | X                        | 44   | —  | —   | —   |
| General Public Utility(H) . . . . .         | —                        | —  | N/A  | —   | —   |
| Pennsylvania Power & Light . . . . .        | —                        | —  | —  | (w)   | —   |
| Philadelphia Electric . . . . .             | X                        | —  | —  | —   | —   |
| Potomac Electric Power . . . . .            | —                        | —  | —  | —   | 42  |
| Virginia Electric & Power . . . . .         | X                        | —  | —  | —   | —   |
| Duquesne Light . . . . .                    | —                        | —  | —  | —   | 30  |
| <b>IV. South Atlantic</b>                   |                          |  |  |   |   |
| Carolina Power & Light . . . . .            | —                        | —  | 74   | 420/o   | —   |
| Duke Power . . . . .                        | —                        | —  | —  | (W) 42  | —   |
| Florida Power & Light . . . . .             | —                        | 74   | —  | (W) 61  | 34  |
| Gulf State Utilities . . . . .              | X                        | N/A  | —  | —   | —   |
| Kentucky Utilities . . . . .                | —                        | —  | 106  | —   | —   |
| Louisville Gas & Electric . . . . .         | X                        | N/A  | 106  | —   | —   |
| Middle South Utility . . . . .              | —                        | 73   | N/A  | —   | —   |
| South Carolina Electric & Gas . . . . .     | X                        | —  | —  | 42  | —   |
| Tampa Electric . . . . .                    | —                        | —  | —  | (W) 61  | —   |
| <b>V. Midwest</b>                           |                          |  |  |   |   |
| Cincinnati Gas & Electric . . . . .         | X                        | —  | 71   | —   | —   |
| Cleveland Electric & Illuminating . . . . . | —                        | —  | —  | —   | —   |
| Commonwealth Edison . . . . .               | —                        | —  | —  | —   | 30  |
| Dayton Power & Light . . . . .              | X                        | —  | —  | (w)   | —   |
| Detroit Edison . . . . .                    | —                        | —  | —  | —   | —   |
| Illinois Power . . . . .                    | X                        | —  | —  | —   | —   |
| Northern Indiana Public Service . . . . .   | X                        | —  | 83   | —   | —   |
| Northern States . . . . .                   | X                        | —  | —  | —   | —   |
| Minnesota Power & Light . . . . .           | —                        | —  | 129  | (w)   | —   |
| Ohio Edison . . . . .                       | —                        | —  | —  | (w)   | —   |
| Toledo Edison . . . . .                     | X                        | —  | —  | (w)   | —   |
| Wisconsin Electric Power . . . . .          | —                        | —  | —  | —   | —   |
| <b>VI. Southwest</b>                        |                          |  |  |   |   |
| Houston Industries(H) . . . . .             | —                        | 85   | N/A  | —   | —   |
| Oklahoma Gas & Electric . . . . .           | X                        | 62   | —  | —   | —   |
| Southwestern Public Service . . . . .       | —                        | N/A  | —  | —   | —   |
| Texas Utilities . . . . .                   | —                        | 53   | N/A  | —   | N/A   |
| <b>VII. Central</b>                         |                          |  |  |   |   |
| Kansas City Power & Light . . . . .         | —                        | —  | 72   | —   | 38  |

**Table 78.—Utility Characteristics That May Influence the Development of Conservation Programs—Continued**

| Region and name of utility           | Electric and gas company | Oil and/or gas more than 40 percent of generating capacity (percent) | Planned capacity additions > 70 percent of existing capacity (percent) | Electricity > 40 percent of residential energy use in area W = winter peak (percent) | Commercial electricity > 30 percent of total load (percent) |
|--------------------------------------|--------------------------|--|--|--|---|
| <b>VIII. North Central</b>           |                          |  |  |  |   |
| Montana Dakota Utility . . . . .     | —                        | —  | —  | —  | —   |
| Public Service Colorado. . . . .     | X                        | —  | 104%   | —  | 32%   |
| Utah Power & Light. . . . .          | —                        | —  | —  | —  | —   |
| <b>IX. West</b>                      |                          |  |  |  |   |
| Arizona Public Service . . . . .     | X                        | —  | 185  | 44%  | 31  |
| Pacific Gas & Electric. . . . .      | X                        | 67%  | 90   | —  | 36  |
| San Diego Gas & Electric . . . . .   | X                        | 94   | —  | —  | —   |
| Southern California Edison . . . . . | —                        | 74   | —  | —  | —   |
| Tucson Electric Power . . . . .      | —                        | —  | —  | 44   | —   |
| <b>X. Northwest</b>                  |                          |  |  |  |   |
| Pacific Power & Light . . . . .      | —                        | N/A  | —  | (w) 54   | —   |
| Portland General Electric. . . . .   | —                        | —  | 134  | —  | —   |
| Puget South Power& Light . . . . .   | —                        | —  | 344  | (w) 50   | —   |

(H) = Holding company.  
 . = Electricity imported from Canada

SOURCE: Detailed data presented in appendix table A.

PG&E’s program are disproportionately moderate and upper income homeowners. Elderly persons and renters have participated in numbers far below their share of PG&E’s customer base.<sup>28</sup> In its brief submitted for a court challenge to the program, TURN estimated that participants in the conservation program would receive a net gain of about \$780 million (above costs) in utility bill savings while ratepayers would subsidize these benefits by about \$550 million.<sup>29</sup> PG&E itself calculates that savings from deferred capacity will not exceed the costs of conservation programs until 14 years into the program for electricity and 17 years for gas.<sup>30</sup> The results cited above are highly sensitive to particular assumptions about rate structure and assumptions about the impact of conservation on consumption patterns and the need for new capacity. At the same time they illustrate the

controversy surrounding the consumer impact of utility conservation programs.

### Retrofit Business Perspective on Utility Conservation Programs

Solar and conservation retrofit businesses have raised the concern with Federal and State governments that utility conservation programs will be unfairly competitive with existing retrofit businesses, because the utility has monthly contact with its customers that it can use for marketing purposes and because customers may have confidence in a utility’s work even when the utility has no track record in energy retrofit. Challenges of this sort led to regulations in the Residential Conservation Service (RCS) program—restricting utility auditors from installing any retrofit they recommend and requiring a very open process of utility referrals to retrofit contractors.

### Conclusion

Utilities are very likely to continue launching energy conservation programs even if they are

<sup>28</sup>Citation from California PUC case No. 59537, included in a working paper to be published by OTA in conjunction with this study, *Fostering Equity in Urban Conservation; Utility Metering and Utility Financing*, Steven Ferrey & Associates, January 1981, pp. 65-67.

<sup>29</sup>Ferrey, *op. cit.*, p. 69.

<sup>30</sup>California PUC case No. 59537, cited in Ferrey, *op. cit.*, p. 69.

not required to by the Federal Government. Those audit programs launched primarily to maintain good customer relations (and also to foster a conservation climate) are likely to affect relatively small numbers of buildings each year, primarily single-family residences with fairly educated and fairly high-income owners.

Those programs launched to earn profits as unregulated subsidiaries, if successful, will have specific markets and purposes resulting from the need to compete successfully with nonutility businesses. These are unlikely to lead to large-scale general retrofit of city buildings and are very likely to be targeted on the commercial buildings, builders of new buildings, and upper income homeowners who have been the major clients of the existing energy management enterprises.

Few gas companies are likely to launch energy management programs to earn regulated profits per se although they may have such programs for good customer relations. A few electric utilities are likely to follow the lead of NEES and incorporate ambitious energy conservation and load management programs into their plans for new generating capacity. Such programs are likely to be aimed at commercial building owners except in those regions with heavy emphasis on residential electric heat. Until there is more experience with the marketing methods and technical results of these programs, however, the number of utilities which undertake them is likely to be very limited. They may have a major impact on certain kinds of city buildings in those few regions with these innovative utilities.

## APPENDIX 8A.—ELECTRIC UTILITY STATISTICS

| No. | Company name                                | Annual peak occurs' (kW) | Average residential rate' (cents/kWh) | Percent residential/commercial load' (percent) | Residential electric energy' (percent) | Percent of generation' |      |      |         |       | Peak load/total capacity | Nonfuel costs as a percent of total revenues' | Mw addition as a percent of existing Mw | Market-to-book ratio' | Joint electric and gas company |
|-----|---|--------------------------|---------------------------------------|--|--|------------------------|------|------|---------|-------|--------------------------|---|---|-----------------------|--------------------------------|
|     |   |                          |                                       |  |  | Coal                   | Oil  | Gas  | Nuclear | Hydro |                          |   |   |                       |                                |
| b 1 | Allegheny Power . . . . .                   | N.A.                     | 4.00                                  | N.A.   | 13                                     | 99                     | —    | —    | —       | 1     | N.A.                     | N.A.  | N.A.                                    | 66                    | —                              |
| 2   | Arizona Public Service . . . . .            | 2,579,300 (s)            | 5.58                                  | 29/31  | 44                                     | 84                     | 9    | 7    | —       | —     | 8                        | 80  | 185                                     | 77                    | X                              |
| 3   | Baltimore Gas & Electric . . . . .          | 3,621,000 (S)            | 4.95                                  | 34/18  | 25                                     | 27                     | 12   | 3    | 55      | 3     | 25                       | 66  | 66                                      | 69                    | X                              |
| 4   | Boston Edison . . . . .                     | 2,378,000 (S)            | 6.39                                  | 22/38  | 13                                     | —                      | 78   | —    | 22      | —     | 16                       | 65  | 43                                      | 69                    | —                              |
| 5   | Carolina Power & Light . . . . .            | 5,907,000 (S)            | 4.08                                  | 26/16  | 42                                     | 58                     | 1    | —    | 39      | 2     | 19                       | 70  | 74                                      | 70                    | —                              |
| 6   | Cincinnati Gas & Electric . . . . .         | 2,978,000 (S)            | 3.85                                  | 30/19  | 18                                     | 99                     | 1    | —    | —       | —     | 21                       | 60  | 23                                      | 76                    | X                              |
| 7   | Cleveland Electric & Illuminating . . . . . | 3,233,000 (s)            | 5.48                                  | 23/21  | 18                                     | 82                     | 3    | —    | 15      | —     | 29                       | 66  | 53                                      | 76                    | —                              |
| 8   | Commonwealth Edison . . . . .               | 13,804,000 (S)           | 5.11                                  | 28/30  | 16                                     | 50                     | 8    | 2    | 40      | —     | 27                       | 70  | 71                                      | 68                    | —                              |
| 9   | Consolidated Edison . . . . .               | 6,702,000 (s)            | 10.50                                 | 26/157   | 13                                     | —                      | 57   | 10   | 33      | —     | 29                       | 77  | 20                                      | 53                    | X                              |
| 10  | Dayton Power & Light . . . . .              | 2,105,000 (w)            | 4.55                                  | 35/19  | 18                                     | N.A.                   | N.A. | N.A. | N.A.    | N.A.  | 17                       | 62  | 49                                      | 67                    | X                              |
| 11  | Delmarva Power & Light . . . . .            | 2,289,300 (W)            | 5.90                                  | 24/20  | 24                                     | 38                     | 44   | —    | 18      | —     | -2                       | 40  | 24                                      | 75                    | X                              |
| 12  | Detroit Edison . . . . .                    | 6,829,000 (S)            | 5.11                                  | 28/16  | 15                                     | 90                     | 9    | 1    | —       | —     | 24                       | 64  | 54                                      | 64                    | —                              |
| 13  | Duke Power . . . . .                        | 9,844,000 (w)            | 3.90                                  | 26/18  | 42                                     | 65                     | —    | —    | 33      | 2     | 18                       | 61  | 53                                      | 73                    | —                              |
| 14  | Duquesne Light . . . . .                    | 2,296,000 (s)            | 6.23                                  | 22/30  | 23                                     | 88                     | 1    | —    | 11      | —     | 27                       | 72  | 25                                      | 75                    | —                              |
| 15  | Florida Power & Light . . . . .             | 9,732,000 (w)            | 4.66                                  | 51/34  | 61                                     | —                      | 57   | 17   | 26      | —     | 11                       | 67  | 21                                      | 77                    | —                              |
| 16  | General Public Utilities . . . . .          | N.A.                     | N.A.                                  | N.A.   | 17                                     | 73                     | 11   | 1    | 15      | —     | N.A.                     | N.A.  | N.A.                                    | 21                    | —                              |
| 17  | Gulf States Utilities . . . . .             | 5,229,300 (S)            | 3.90                                  | 19/13  | 31                                     | N.A.                   | N.A. | N.A. | N.A.    | N.A.  | 12                       | 53  | 54                                      | 71                    | X                              |
| 18  | Houston Industries . . . . .                | N.A.                     | N.A.                                  | N.A.   | 31                                     | 15                     | —    | 85   | —       | —     | N.A.                     | N.A.  | N.A.                                    | 79                    | —                              |
| 19  | Illinois Power . . . . .                    | 3,019,214 (S)            | 4.29                                  | 28/18  | 16                                     | 96                     | 3    | 1    | —       | —     | 24                       | 55  | 48                                      | 84                    | X                              |
| 20  | Kansas City Power & Light . . . . .         | 1,964,000 (S)            | 5.37                                  | 29/38  | 19                                     | 93                     | 4    | 3    | —       | —     | 23                       | 76  | 72                                      | 67                    | —                              |
| 21  | Kentucky Utilities . . . . .                | 1,967,000 (s)            | 3.90                                  | 26/15  | 18                                     | 99                     | —    | —    | —       | 1     | 13                       | 61  | 106                                     | 73                    | —                              |
| 22  | Long Island Lighting . . . . .              | 2,919,000 (s)            | 7.20                                  | 42/15  | 13                                     | N.A.                   | N.A. | N.A. | N.A.    | N.A.  | 28                       | 66  | 81                                      | 77                    | X                              |
| 23  | Louisville Gas & Electric . . . . .         | 1,752,000 (S)            | 3.66                                  | 30/22  | 18                                     | N.A.                   | N.A. | N.A. | N.A.    | N.A.  | 30                       | 58  | 106                                     | 74                    | X                              |
| 24  | Middle South Utility . . . . .              | N.A.                     | N.A.                                  | N.A.   | 32                                     | 7                      | 29   | 44   | 20      | —     | N.A.                     | N.A.  | N.A.                                    | 68                    | —                              |
| 25  | Minnesota Power & Light . . . . .           | 1,272,277 (W)            | 5.08                                  | 8/6  | 14                                     | 81                     | 5    | —    | —       | 14    | -52                      | 86  | 129                                     | 79                    | —                              |
| 26  | Montana Dakota Utility . . . . .            | N.A.                     | N.A.                                  | 44/27  | 19                                     | 98                     | 1    | 1    | —       | —     | 16                       | 80  | 0                                       | 103                   | —                              |
| 27  | New England Electric . . . . .              | 3,183,000 (w)            | 6.02                                  | N.A.   | 13                                     | 20                     | 58   | —    | 14      | 8     | 18                       | N.A.  | N.A.                                    | 77                    | —                              |
| 28  | Niagara Mohawk Power . . . . .              | 5,641,000 (W)            | 4.35                                  | 25/29  | —                                      | N.A.                   | N.A. | N.A. | N.A.    | N.A.  | -18                      | 69  | 98                                      | 69                    | X                              |
| 29  | Northeast Utilities . . . . .               | 3,955,200 (W)            | 5.20                                  | N.A.   | 20                                     | —                      | 45   | —    | 51      | 4     | 36                       | N.A.  | N.A.                                    | 62                    | X                              |
| 30  | Northern Indiana Public Service . . . . .   | 2,243,650 (S)            | 5.45                                  | 16/3   | 17                                     | 99                     | 1    | —    | —       | —     | 28                       | 72  | 83                                      | 62                    | X                              |
| 31  | Northern States . . . . .                   | N.A.                     | N.A.                                  | 25/12  | 14                                     | 54                     | 1    | —    | 42      | 3     | N.A.                     | 81  | 21                                      | 79                    | X                              |
| 32  | Ohio Edison . . . . .                       | 3,556,000 (W)            | 5.39                                  | 30/21  | 18                                     | 94                     | 2    | —    | 4       | —     | 27                       | 68  | 0                                       | 81                    | —                              |
| 33  | Oklahoma Gas & Electric . . . . .           | 3,630,000 (S)            | 3.60                                  | 28/16  | 25                                     | 38                     | —    | 62   | —       | —     | 28                       | 47  | 67                                      | 79                    | —                              |
| 34  | Orange and Rock utility . . . . .           | 662,000 (S)              | 8.50                                  | 20/14  | 13                                     | —                      | 55   | 40   | —       | 5     | 36                       | 66  | 51                                      | 71                    | X                              |
| 35  | Pacific Gas & Electric . . . . .            | 13,215,200 (S)           | 3.54                                  | 33/36  | 31                                     | —                      | 28   | 39   | —       | 23a   | -19                      | 63  | 90                                      | 71                    | X                              |
| 36  | Pacific Power & Light . . . . .             | 4,084,000 (w)            | 2.55                                  | 29/20  | 54                                     | N.A.                   | N.A. | N.A. | N.A.    | N.A.  | -3                       | 87  | 0                                       | 90                    | —                              |
| 37  | Pennsylvania Power & Light . . . . .        | 4,427,000 (W)            | 4.24                                  | 36/25  | 23                                     | 79                     | 19   | —    | —       | 2     | 36                       | 41  | 62                                      | 68                    | —                              |
| 38  | Philadelphia Electric . . . . .             | 5,627,000 (s)            | 5.80                                  | 28/10  | 23                                     | N.A.                   | N.A. | N.A. | N.A.    | N.A.  | 27                       | 73  | 25                                      | 69                    | X                              |
| 39  | Portland General Electric . . . . .         | N.A.                     | 2.78                                  | 40/26  | 54                                     | 14                     | 6    | 1    | 50      | 29    | N.A.                     | 98  | 134                                     | 71                    | —                              |
| 40  | Potomac Electric Power . . . . .            | 3,804,000 (S)            | 5.02                                  | 24/12  | 25                                     | 85                     | 15   | —    | —       | —     | 24                       | 52  | 0                                       | 77                    | —                              |
| 41  | Public Service Colorado . . . . .           | 2,575,400                | 4.87                                  | 26/32  | 16                                     | 80                     | 1    | 15   | 4       | —     | -1                       | 69  | 104                                     | 75                    | X                              |
| 42  | Public Service Electric & Gas . . . . .     | 6,736,000 (S)            | 7.00                                  | 26/135   | 17                                     | 33                     | 26   | 6    | 35      | —     | 32                       | 72  | 32                                      | 67                    | X                              |
| 43  | Public Service New Hampshire . . . . .      | 1,152,000 (s)            | 5.78                                  | 31/11  | 15                                     | 83                     | 1    | 16   | —       | —     | 24                       | 72  | 184                                     | 67                    | —                              |

| No | Company name                            | Annual peak occurs' (kW) | Average residential rate' (cents/kWh) | Percent residential/commercial load' (percent) | Residential electric energy' (percent) | Percent of generation' |      |      |         |       | Peak load/total capacity | Nonfuel costs as a percent of total revenues' | Mw addition as a percent of existing Mw' | Market-to-book ratio' | Joint electric and gas company |
|----|---|--------------------------|---------------------------------------|--|--|------------------------|------|------|---------|-------|--------------------------|---|--|-----------------------|--------------------------------|
|    |   |                          |                                       |  |  | Coal                   | Oil  | Gas  | Nuclear | Hydro |                          |   |  |                       |                                |
| 44 | Puget Sound Power & Light . . . . .     | 3,109,400 (w)            | 2.00                                  | 47/21  | 50                                     | 14                     | 10   | —    | 2       | 74    | 7                        | 95  | 344                                      | 67                    | —                              |
| 45 | Rochester Gas & Electric . . . . .      | 950,000 (w)              | 4.60                                  | 26/22  | 13                                     | 32                     | 16   | —    | 49      | 3     | 10                       | 76  | 113                                      | 62                    | X                              |
| 46 | San Diego Gas & Electric . . . . .      | 2,019,000 (s)            | 5.30                                  | 39/20  | 31                                     | —                      | 74   | 20   | 6       | —     | 17                       | 50  | 0  | 77                    | X                              |
| 47 | South Carolina Electric & Gas . . . . . | 2,965,000 (s)            | 4.72                                  | 30/22  | 42                                     | 84                     | 8    | 1    | —       | 7     | 19                       | 52  | 64                                       | 77                    | X                              |
| 48 | Southern California Edison . . . . .    | 12,464,000 (s)           | 4.72                                  | 27/29  | 31                                     | —                      | 43   | 31   | 3       | 11    | 15                       | 47  | 39                                       | 73                    | —                              |
| 49 | Southern Company . . . . .              | N.A.                     | N.A.                                  | N.A.   | 32                                     | 80                     | 1    | 1    | 12      | 6     | N.A.                     | N.A.  | N.A.                                     | 71                    | —                              |
| 50 | Southwestern Public Service . . . . .   | 2,177,000 (s)            | 5.21                                  | 15/16  | 31                                     | N.A.                   | N.A. | N.A. | N.A.    | N.A.  | 23                       | 43  | 77                                       | 109                   | —                              |
| 51 | Tampa Electric . . . . .                | 1,988,000 (W)            | 5.17                                  | 33/20  | 61                                     | 76                     | 24   | —    | —       | —     | 34                       | 53  | 22                                       | 88                    | —                              |
| 52 | Texas Utilities . . . . .               | N.A.                     | N.A.                                  | N.A.   | 31                                     | 47                     | 1    | 52   | —       | —     | N.A.                     | N.A.  | N.A.                                     | 80                    | —                              |
| 53 | Toledo Edison . . . . .                 | 1,395,000 (w)            | 5.87                                  | 25/16  | 18                                     | 69                     | 1    | —    | 30      | —     | 16                       | 76  | 0  | 69                    | X                              |
| 54 | Tucson Electric Power . . . . .         | 1,247,000 (S)            | 5.85                                  | 19/17  | 44                                     | 69                     | 11   | 20   | —       | —     | 16                       | 66  | 13                                       | 88                    | —                              |
| 55 | Union Electric . . . . .                | 5,557,100 (s)            | 4.37                                  | 27/24  | 19                                     | 9                      | 6    | —    | —       | —     | 17                       | 61  | 35                                       | 68                    | X                              |
| 56 | United Illuminating . . . . .           | 911,300 (s)              | 6.23                                  | 36/33  | 20                                     | —                      | 93   | —    | 7       | —     | 36                       | 47  | 0  | 69                    | —                              |
| 57 | Utah Power & Light . . . . .            | 2,723,000 (S)            | 4.28                                  | 19/14  | 20                                     | 93                     | 1    | 3    | —       | 3     | -1                       | 75  | 44                                       | 87                    | —                              |
| 58 | Virginia Electric & Power . . . . .     | 7,929,000 (S)            | 5.14                                  | 33/25  | 37                                     | 36                     | 27   | —    | 35      | 2     | 14                       | 61  | 34                                       | 57                    | X                              |
| 59 | Wisconsin Electric Power . . . . .      | 3,313,000 (s)            | 4.40                                  | 30/25  | 17                                     | 58                     | 2    | 3    | 35      | 2     | 19                       | 73  | 67                                       | 73                    | —                              |

<sup>a</sup>Fuel mix includes 10 percent geothermal

<sup>b</sup>Holding companies

N.A. = Information is not available

- SOURCES 1 Electrical World, *Directory of Electric Utilities*, 1980-81 Edition, McGraw-Hill Publications Co., 1980.  
 2 Energy Data Report, *Statistics of Privately Owned Electric Utilities in the United States — 1978*, U.S. Department of Energy, October 1979.  
 3 DOE State Energy Data, April 1980. Electricity as a percent of all residential energy end-use.  
 4 Salomon Brothers, "Electric Utility Quality Measurements," 1980.  
 5 Calculated from Electrical World, 1 (peak load/total capacity).  
 6 Projected Mw was obtained from *Inventory of Power Plants in the United States — December 1979*, DOE, June 6, 1980, existing Mw was obtained from Energy Data Report (see footnote 2).  
 7 Salomon Brothers, "Electric Utility Common Stock Market Data," Nov 3, 1980.



## APPENDIX 8B.—EFFECTS OF ISSUING STOCK AT DIFFERENT MARKET PRICES RELATIVE TO BOOK VALUES

The following cases illustrate the earnings per share consequences of issuing common stock at prices above and below book value. For simplicity, assume throughout that the rate of return allowed by regulators is 12 percent on the common equity base at the beginning of any year and that the dividend payout ratio  $b$  is 70 percent. Assuming for the moment that the industry or any given utility issues no stock, the industry's total earnings and dividends will grow at a rate which is 3.6 percent. A 12-percent return and a 30-percent retention of this amount (because dividends are 70 percent of earnings) means that the industry's common equity grows 3.6 percent per year, that earnings grow 3.6 percent because the percentage return on equity is constant, and that dividends grow at 3.6 percent (because the payout ratio is constant). There is a well known formula for stock prices in constant growth situations of this sort which can be written as:

$$P_0 = \frac{D_0}{K_e - g}$$

where:

- $P_0$  = stock price at time 0 relative to book value;
- $D_0$  = dividends at time 0 relative to book value; and
- $K_e$  = investor's required rate of return on investment in stock of this risk class.

Dividends at time 0 can in turn be expressed as a fraction of book value as follows:

where:

$$D_0 = E_0 \times b; \text{ and}$$

$$E_0 = \text{earnings at time 0 relative to book value.}$$

Earnings relative to book value can in turn be written simply as:

where:

$$E_0 = r_e$$

$$r_e = \text{the allowed rate of return on equity}$$

If the required rate of return is 10 or 15 percent, then the industry's market price relative to book value is 1.313 or **0.737, respectively**. Given that, we have assumed no new issues of common stock; these ratios hold on a per-share basis as well.

Consider what happens if the industry's capital expenditure requirements (or desires) are such as to necessitate (or prompt) the one-time issuance of

common stock. For simplicity, first assume that investors either do not anticipate the issuance of common stock or do not react to its predictable consequences; this will simplify the calculations of the number of shares required to raise a given dollar amount of equity capital. The effect of correct anticipations will be discussed secondly. To make points clear, consider two illustrative cases. In the first, assume that investors are willing to settle for a 10-percent return for investing in the industry's common equity. In the second, perhaps either because the risks have increased or because inflation has shifted the general levels of nominal (current dollars) required rates of return upward, assume investors demand a 15-percent return. Also assume initially that the industry's need for common equity capital over time is just met by retained earnings in all years except one. As above, with the exception of the year of the stock issue, this means that required equity grows by 3.5 percent per year, and that earnings, earnings per share, and dividends per share grow at 3.6 percent per year.

### Case 1.—If Allowed Returns on Equity Are Greater Than Investors' Required Rates of Return, Then Earnings per Share, Dividends per Share, and Market Prices Increase With Increasing Growth

Assumptions:

Initial equity, . . . . .  $S_0 = \$1,000,000$

Allowed return on equity . . . . .  $r_e = 12\%$

Earnings . . . . .  $E_0 = \$120,000$

Payout ratio . . . . .  $b = 0.7$

Dividends . . . . .  $D_0 = b \times E_0 =$   
 $\$84,000$

Retained earnings as  
 function of profit  
 to common. . . . .  $a = (1 - b) = .3$

Growth in earnings  
 and dividends. . . . .  $g = a \times r_e =$   
 $.036$

Shares outstanding . . . . .  $n = 100,000$

Return required by  
 investors . . . . .  $k_e = 10\%$

Market price. . . . .  $P_0 = \frac{D_0}{(k_e - g) n.}$   
 $= \$13.42$

The effect of the increased equity investment is to raise earnings, dividends, and market price per share by 2.2 percent. In this instance, because the preissue stock price did not reflect the opportunity to invest \$100,000 at a rate of return above that demanded by the market, both the old shareholders and the new purchasers of stock received a \$0.29 per share "windfall" gain.

If investors correctly anticipate the future need for common equity financing, then prefinancing prices will adjust so as to drive out the postfinancing windfall gain (or loss) to investors. In case 1, prefinancing prices reflect the capitalization of the expected postfinancing dividend stream at 10 percent, thereby boosting the prefinancing price upward and reducing the number of shares required to raise \$100,000 in new capital. Thus, new investors purchase their shares at a price that holds their return on investment to 10 percent; the benefits of the industry's having an opportunity to invest at above-market returns all accrue to the original shareholders. Of course, if after the date of purchase of the new shares the industry unexpectedly has yet another opportunity to invest equity over and above retained earnings at a favorable rate, the "new" investors would share in the second round of windfall gains. If both the first and second opportunity were correctly anticipated at the time of the first issue, however, the stock would have risen in market price so as to reflect all the benefits of both opportunities and to provide both the first and second rounds of new purchases with only their required return on investment.

**Case 2.—if Allowed Returns on Equity Are Less Than Investors' Required Rates of Return, Then Earnings per Share, Dividends per Share, and Market Prices Decrease With Increasing Growth\***

Assumptions:

Same as case 1 except:

$$k_e = 150/0$$

$$P_0 = \frac{D_0}{k_e - g} = \$7.37$$

The market price an investor requiring a 15-percent return will pay for a \$10 book value share is \$7.37.

Suppose again that a sudden requirement for external equity financing of \$100,000 arises too quickly for the market to anticipate and, hence, is financed at \$7.37 per share.

$$s = \$100,000$$

$$E_1 = \$132,000$$

$$n = \frac{s}{P_0} = 13,572 \text{ shares}$$

$$n_1 = 113,572$$

$$e_1 = \frac{E_1}{n_1} = \$1.16$$

$$d_1 = \frac{D_1}{n_1} = \$0.81$$

$$P_1 = \frac{e_1 + d_1}{k_e - g} = \$7.14$$

Selling stock to meet capital needs when the market price is below book drives earnings per share, dividends per share, and market price per share to lower levels.

As in case 1, the effect of investors' correctly anticipating the industry's investment of inadequate rates of return is to accentuate the effect of the simplistic examples. If anticipated, the case 2 investment would be reflected in preissue stock prices less than \$7.37, necessitating the issuance of more than 13,572 shares to raise \$100,000 and thereby exacerbating the investment's damage to earnings and dividends per share.

\* Based on testimony by Dr. Michael L. Tennican before the New York Public Service Commission in case 176.79 proceeding on motion of the commission to investigate the financing plans for major New York combination electric and gas companies, Feb. 4, 1981.

## APPENDIX 8C.—COMPARISON OF STATE ELECTRIC UTILITY REGULATING PRACTICES

| State                | Ranking | Rate base  | Test period                                | Accounting   | Regulatory timing  |
|----------------------|---------|--|--|--|--|
| Alabama              | E       | Year-end original cost                                     | Historical-adjusted                        | Normalization of accounting department and ITC, AFDC offset  | 7 months, interim relief occasionally  |
| Arizona              | c +     | Year-end value, some CWIP                                  | Historical-adjusted                        | Partial normalization of accounting department (TEP) normalizes ITC, (AZP) flows through ITC                       | No statutory limit, recent decision 7-10 months, emergency interim relief      |
| Arkansas             | C+      | Year-end original cost                                     | Historical-adjusted                        | Normalization of accounting department and ITC, AFDC offset, deferred fuel   | 6-8 months, emergency interim relief   |
| California           | C+      | Average original cost                                      | Projected                                  | Flowthrough of accounting department and ITC, deferred fuel  | 12 months, interim relief occasionally   |
| Colorado             | C+      | Year-end original cost, some CWIP                          | Partially projected                        | Normalization of accounting department and ITC   | 8 months, interim relief   |
| Connecticut          | C       | Year-end original cost, no CWIP                            | Historical-adjusted                        | Flowthrough of accounting department and 1971 ITC Unbilled revenue and deferred fuel                               | 5-month statutory plus 1-month notice, infrequent interim relief               |
| Delaware             | C+      | Average original cost<br>Some CWIP for pollution control   | Historical-adjusted                        | Normalization of post Jan. 1, 1975 accounting department and ITC, deferred fuel                                    | 7-month statutory recent decision 7-10 months, interim relief up to 15 percent |
| District of Columbia | D       | Year-end original cost                                     | Historical-adjusted                        | Normalization of Jan. 1975 accounting department and 6 percent ITC, deferred fuel and unbilled revenue AFDC offset | No statutory limit 9-24 months possible, emergency interim relief              |
| Florida              | B+      | Average original cost, some CWIP                           | Projected                                  | Normalization of accounting department and ITC, deferred fuel  | 8-month statutory, interim relief  |
| Georgia              | D       | Year-end or average original cost                          | Partially projected                        | Normalization of accounting department and ITC, AFDC offset  | 6-month statutory, some emergency interim relief                               |
| Hawaii               | B-      | Average original cost                                      | Historical-adjusted                        | Normalization of accounting department and ITC, deferred fuel  | 9-month statutory, no interim relief   |
| Idaho                | C       | Year-end original cost, some CWIP                          | Historical-adjusted or partial projected   | Normalization of accounting department and ITC   | 7-month statutory, infrequent interim relief                                   |
| Illinois             | C       | Year-end original cost, modified for fair value, some CWIP | Partially projected or historical-adjusted | Normalization of accounting department and ITC   | 1 1-month statutory infrequent interim relief                                  |

| State         | Ranking | Rate base  | Test period                      | Accounting  | Regulatory timing   |
|---------------|---------|--|----------------------------------|---|---|
| Indiana       | A       | Year-end fair value, 30 %/0-45 %/0 above original cost           | Historical-adjusted              | Normalization of accounting department and ITC, deferred fuel   | 6-10 months, no statutory requirement, emergency interim relief                 |
| Iowa          | C-      | Average original cost  | Historical                       | Normalization of accounting department and ITC  | 18-24 months, interim rates are allowed 1-4 months after application            |
| Kansas        | c       | Year-end original cost   | Historical-adjusted              | Normalization of accounting department, repair allowances and ITC   | 8 months, interim relief occasionally   |
| Kentucky      | B-      | Year-end original cost, CWIP included                            | Historical-adjusted              | Normalization of accounting department and ITC  | 10-month statutory, interim relief goes into effect 5½ months after application |
| Louisiana     | D       | Average original cost, some CWIP                                 | Historical-adjusted              | Normalization of accounting department and ITC, deferred fuel   | 12 months, interim relief   |
| Maine         | C-      | Average original cost  | Historical-adjusted              | Normalization of ITC and most accounting departments  | 9-month statutory, emergency interim relief                                     |
| Maryland      | C       | Average original cost, fair value by statute, some CWIP included | Historical-adjusted              | Normalization of ITC and most accounting departments  | 7-month statutory, 3 months on make whole, no interim relief                    |
| Massachusetts | C       | Year-end original cost   | Historical-adjusted              | Normalization of accounting department and ITC, deferred fuel   | 6-month statutory, limited interim relief                                       |
| Michigan      | C       | Average original cost  | Projected or partially-projected | Normalization of accounting department and ITC, AFDC offset   | 9-month statutory, recent orders, 12-18 months, emergency interim relief        |
| Minnesota     | C       | Average original cost, some CWIP included                        | Projected                        | Normalization of accounting department and ITC, deferred fuel   | 12-month statutory 9-10 months, interim rates 90 days                           |
| Mississippi   | D       | Average original cost, fair value by statute                     | Projected                        | Normalization of accounting department and ITC, AFDC offset   | 6 months, interim rates go into effect 1 month after filing                     |
| Missouri      | E       | Year-end original cost   | Historical-adjusted              | Normalization of accounting department and ITC  | 1 l-month statutory, emergency interim relief                                   |
| Montana       | D       | Average original cost, no CWIP                                   | Historical-adjusted              | Normalization of accounting department and ITC  | 9-month statutory, emergency interim relief                                     |
| Nevada        | c +     | Year-end original cost, some CWIP                                | Historical-adjusted              | Normalization of ITC, (SRP) normalizes accounting department (NVP) flows through accounting department, un-billed revenue | 6-month statutory, no interim relief  |
| New Hampshire | C+      | Average original cost  | Historical-adjusted              | Normalization of ITC and most accounting departments, deferred fuel   | 12-month statutory, interim relief  |

| State          | Ranking | Rate base  | Test period                                | Accounting  | Regulatory timing  |
|----------------|---------|--|--|---|--|
| New Jersey     | c +     | Year-end original cost, some CWIP                        | Historical-adjusted or partially projected | Normalization of accounting department and ITC, deferred fuel                       | 9-month statutory, emergency interim relief                          |
| New Mexico     | B -     | Year-end original cost, fair value by statute, some CWIP | Historical-adjusted                        | Normalization of accounting department and ITC, deferred fuel                       | 4-10 months, infrequent interim relief                               |
| New York       | C       | Year-end or average original cost, some CWIP             | Projected                                  | ADR and post 1975 ITC normalized, balance flowed through, deferred fuel             | 1 1-month statutory, emergency interim relief                        |
| North Carolina | B       | Year-end original cost, some CWIP included               | Historical-adjusted                        | Normalization of accounting department and ITC, deferred fuel                       | 7 months, infrequent interim relief                                  |
| North Dakota   | E       | Average original cost                                    | Historical-adjusted or projected           | Normalization of accounting department and ITC                                      | 12-month statutory, decision usually 5-9 months, some interim relief |
| Ohio           | C +     | Average original cost, some CWIP                         | Partially projected                        | Normalization of accounting department and ITC                                      | 9 months, emergency interim relief                                   |
| Oklahoma       | C -     | Year-end original cost                                   | Historical-adjusted                        | Normalization of accounting department and ITC                                      | 8-12 months, emergency interim relief                                |
| Oregon         | C +     | Average original cost                                    | Projected                                  | Most tax deferrals from liberalized depreciation are flowed through, ITC normalized | 10-month statutory, no interim relief                                |
| Pennsylvania   | C -     | Year-end original cost, pollution control CWIP only      | Partially projected                        | Deferred fuel   | 9-month statutory, emergency interim relief                          |
| Rhode Island   | D       | Average original cost                                    | Historical-adjusted                        | Normalization of accounting department and ITC                                      | 9 months, no interim rates   |
| South Carolina | c +     | Year-end original cost, some CWIP                        | Historical-adjusted                        | Normalization of accounting department and ITC, deferred fuel                       | 10-13 months, interim rates after 30 days                            |
| South Dakota   | E       | —  | Historical-adjusted                        | Normalization of ITC and most accounting departments                                | 6 months, some interim relief  |
| Texas          | A       | Year-end original cost, fair value by statute, some CWIP | Historical-adjusted                        | Normalization of accounting department and ITC                                      | 4-6 months, no interim relief  |
| Utah           | A -     | Average original cost, some CWIP                         | Partially estimated                        | Normalization of accounting department and ITC, deferred fuel, unbilled revenue     | 8-month statutory, some interim relief                               |
| Vermont        | C +     | Average original cost, some CWIP included                | Historical-adjusted                        | Flowthrough of accounting department, ITC normalized                                | 6-18 months, emergency interim relief                                |
| Virginia       | C       | Year-end original cost, some CWIP                        | Historical-adjusted                        | Normalization of accounting department and ITC, deferred fuel                       | 5 months statutory, emergency interim relief                         |

| State         | Ranking | Rate base                                       | Test period         | Accounting  | Regulatory timing  |
|---------------|---------|---|---------------------|---|--|
| Washington    | C       | Average original cost, inclusion of CWIP varies | Historical-adjusted | Normalization or flow through varies depending on utility     | 1 1-month statutory, emergency interim relief                |
| West Virginia | D       | Average original cost, some CWIP                | Historical-adjusted | Flow through or accounting department, ITC normalized         | 12 months plus (no limit), some interim relief               |
| Wisconsin     | B       | Average original cost, some CWIP                | Projected           | Normalization of accounting department and ITC, deferred fuel | 9-12 months, most interims granted (4-5 months after filing) |
| Wyoming       | c +     | Year-end original or historical cost            | Historical-adjusted | Normalization of accounting department and ITC, AFDC offset   | 6-9 months, some interim relief                              |

NOTE: On abbreviations CWIP means construction work in progress can be included in the rate base, ITC means Investment tax credit, AFDC means allowance for funds used during construction

SOURCE: Salomon Brothers, Industry Analysis, February 17, 1981.

**Chapter 9**

**Public Sector Role in  
Urban Building Energy Conservation**

# Contents

|   |             |
|---|-------------|
|   | <i>Page</i> |
| <b>Federal Government Programs. . . . .</b>       | <b>242</b>  |
| <b>Information and Marketing of Building</b>      |             |
| <b>Retrofit . . . . .</b>                         | <b>243</b>  |
| <b>Financing. ,... . . . .</b>                    | <b>245</b>  |
| <b>Summary: impact of Federal Programs</b>        |             |
| <b>on Building Retrofit . . . . .</b>             | <b>249</b>  |
| <b>Role of State Governments. . . . .</b>         | <b>250</b>  |
| <b>Regulation of Investor-Owned Utilities, ..</b> | <b>250</b>  |
| <b>Building Codes . . . . .</b>                   | <b>251</b>  |
| <b>Allocating Federal Funds. .. . . .</b>         | <b>252</b>  |
| <b>Financing . . . . .</b>                        | <b>253</b>  |
| <b>Conclusion . . . . .</b>                       | <b>254</b>  |
| <b>Role of City Governments. . . . .</b>          | <b>254</b>  |
| <b>City Resources for Building Retrofit. ..</b>   | <b>257</b>  |
| <b>Conclusion . . . . .</b>                       | <b>260</b>  |
| <b>Nonprofit Organizations . . . . .</b>          | <b>260</b>  |
| <b>Energy Cooperatives. . . . .</b>               | <b>261</b>  |
| <b>Conclusions. . . . .</b>                       | <b>263</b>  |
| <b>When the City Government is the</b>            |             |
| <b>Building Owner . . . . .</b>                   | <b>265</b>  |

|   |             |
|---|-------------|
|   | <i>Page</i> |
| <b>80. Response to Energy Credits by</b>          |             |
| <b>Income Class, 1978 and 1979. ... ..</b>        | <b>245</b>  |
| <b>81. Use of Residential Energy Tax Credits</b>  |             |
| <b>for Energy Conservation and</b>                |             |
| <b>Renewable Retrofits, 1978.....</b>             | <b>246</b>  |
| <b>82. Distribution of Residential Energy Tax</b> |             |
| <b>Credits by Amount of Credit, 1978.....</b>     | <b>246</b>  |
| <b>83. Dwelling Units Rehabilitated Under</b>     |             |
| <b>Four Federal Housing Rehabilitation</b>        |             |
| <b>Programs, 1975-80. , .....,.....</b>           | <b>247</b>  |

## FIGURE

|  |             |
|--|-------------|
| <i>Figure No.</i>                            | <i>Page</i> |
| <b>57. Organizations Which influence the</b> |             |
| <b>Energy Retrofit Of Housing for Low-</b>   |             |
| <b>Income people. ,..... . . . .</b>         | <b>254</b>  |

## BOX

|  |             |
|--|-------------|
| <b>O. A Sampling of Nonprofit Groups, ..</b> | <i>Page</i> |
|  | <b>263</b>  |

## LIST OF TABLES

|  |             |
|--|-------------|
| <i>Table No.</i>                         | <i>Page</i> |
| <b>79. Recent History of 1982 Budget</b> |             |
| <b>Proposals Affecting Energy</b>        |             |
| <b>Conservation in Buildings. ....</b>   | <b>242</b>  |



## Public Sector Role in Urban Building Energy Conservation

---

previous chapters of this report have assessed the likelihood that building owners will make investments in **energy efficiency as well as the likelihood that private marketing efforts by utilities and energy conservation companies** will succeed in persuading owners to retrofit. This chapter assesses public and nonprofit building retrofit programs and their likely impact on building owners.

Although many States, cities, and nonprofit and community groups have their own unique energy conservation programs, the framework for much energy conservation activity has been provided since 1973 by either Federal energy programs or by Federal housing rehabilitation and urban development programs. **Federal programs have provided sources of funding, regulatory authority, or technical assistance to these other, more local programs. For this reason, this chapter begins with a brief review of the most important Federal programs.**

**January 1982 marked the end of a year of extensive debate about the role of government in both energy and housing and urban development programs.** The outcome of the debate is still unclear. Before the debate began it was generally accepted that government should have a major role in both the promotion of energy retrofit in buildings and in urban building rehabilitation and economic development. Controversy about government energy programs was largely limited to the most effective form of the government role, and the proper degree of interaction between energy programs being operated by the Department of Energy (DOE), and housing and urban programs being operated by the Department of Housing and Urban Development (HUD). After nearly 7 years since the oil embargo, the period of experimentation by "pathfinder" communities such as Portland, Oreg., and St. Paul, Minn., was largely over and several effective models for successful State and local energy conservation programs had been developed that were likely to be adaptable to other communities. The cur-

rent debate about the role of the Federal Government in energy conservation and housing interrupted what might be called the "second round" in which a second group of cities and States were beginning to institute types of programs that had already been successful elsewhere. The impact of the 1981 rapid shifts in Federal programs on the second round of State and local efforts in energy conservation cannot now be determined.

Following the description of the Federal programs, this chapter describes the general possibilities for State, city, and nonprofit programs within their constraints of tradition, authority, and resources. However, general prospects for public sector programs do not begin to capture the great variety of influences on State and local programs from their history, regional energy situation, and the fortuitous combinations of people and institutions that help to bring about innovative programs. To illustrate the inherently local character of programs that foster building energy efficiency, chapter 10 is entirely devoted to two kinds of case study. One set of case studies consists of brief descriptions of successful city programs among the "pathfinder" cities. A second set of case studies describes the full range of energy conservation activities in each of five typical cities: Buffalo, N.Y.; Des Moines, Iowa; Jersey City, N. J.; Tampa, Fla.; and San Antonio, Tex. Such descriptions are the best way to capture the many influences on building energy efficiency in a particular area, whether they are State or city government, public utilities, chamber of commerce, or community groups.

The end of this chapter also includes a section on the potential for retrofit of publicly owned buildings. In all the discussion of public sector programs to stimulate private sector retrofit, it should not be overlooked that city governments are also responsible for the energy efficiency of their own buildings. The last section of this chapter describes OTA's findings on the prospects for public sector retrofit of buildings.

## FEDERAL GOVERNMENT PROGRAMS

Three strands of traditional Federal policy converge to influence the energy retrofit prospects of buildings in cities. Building energy conservation programs, operated by DOE, are designed to stimulate energy conservation in buildings as a means of reducing our overall dependence on imported energy supplies and of reducing the likelihood of future sharp increases in energy prices. Housing and urban development programs, operated by HUD, are designed to stimulate rehabilitation of low- and moderate-income housing and the economic revival of neighborhoods and cities. Finally, income assistance programs include assistance to households in paying for high-energy costs due to recent price increases.

A change in party control in both the executive branch and the Senate has prompted a sharp debate, focused on the 1982 and 1983 budgets, about the proper role of government

in all three categories of programs. Table 79 illustrates clearly the controversy surrounding energy conservation programs. Compared to a total of more than **\$800** million appropriated in 1981 for energy conservation programs (including transportation and industrial energy conservation), the revised Reagan administration budget for 1982 (as of September 1981) retained somewhat less than \$200 million. The omnibus Reconciliation Act of July 1981 restored the amount to more than \$550 million and the appropriations bill settled on \$400 million, including funds deferred from 1981.

For income assistance, the 1982 budget controversy was less sharp. The Reagan administration proposed a cut in energy assistance from \$1,850 million to \$1,400 million. Among the housing and urban development programs the 1982 budget controversy touched the Urban Development Action Grant Program but not the

**Table 79.—Recent History of 1982 Budget Proposals Affecting Energy Conservation in Buildings (millions of dollars)**

|   | Original enacted fiscal year 1981 appropriations | Fiscal year 1982 budget            |                             |                           |
|---|--|------------------------------------|-----------------------------|---------------------------|
|   |  | Revised Reagan budget <sup>b</sup> | Congressional authorization | Appropriations conference |
| <b>Energy conservation programs</b>               |  |                                    |                             |                           |
| Energy conservation total <sup>a</sup> .....      | \$802.8  | \$171.6                            | \$558.0                     | \$402.3                   |
| State and local conservation programs, total. . . | 452.9  | 94.0                               | 351.0                       | 244.0                     |
| Low-income weatherization. . . . .                | 182.0  |                                    | 175.0                       | 150.0                     |
| Schools and hospitals. . . . .                    | 181.0  | 87.0                               | NS                          | 50.0                      |
| Energy extension service. . . . .                 | 20.0   | 0                                  | 15.0                        | 10.0                      |
| State energy conservation programs. . . . .       | 47.8   | 0                                  | NS                          | 25.0                      |
| Buildings and community systems, total. . . . .   | 113.7  | 27.4                               | NS                          | 49.7                      |
| Residential conservation service. . . . .         | 14.7   | NA                                 | 2.2                         | 3.5                       |
| Community systems (district heating, etc.). .     | 13.6   | NA                                 | 4.4                         | 4.0                       |
| Analysis/technology transfer. . . . .             | 5.9  | NA                                 | 2.0                         | 2.0                       |
| Solar and conservation bank. . . . .              | 121.0  | 0                                  | 50.0                        | —                         |
| Appropriate technology grants. . . . .            | 12.0   | 0                                  | 5.0                         | 3.0                       |
| <b>Energy assistance programs</b>                 |  |                                    |                             |                           |
| Low-income energy assistance. . . . .             | 1,850.00   | 1,400.0                            | 1,875.0                     | 1,875.0                   |
| <b>Housing and Urban Development programs</b>     |  |                                    |                             |                           |
| Community development block grants. . . . .       | 3,695.0  | 4,177.0                            | 3,660.0 \$                  | 3,660.0                   |
| Urban development action grants. . . . .          | 675.0  | 300.0                              | 500.0                       | 440.0                     |
| HUD innovative grants. . . . .                    | 83.1   | NA                                 | NA                          | NA                        |

NA—not available.

NS—Not separately specified.

<sup>a</sup>See app. table A. I for history of fiscal years 1977-81 appropriations for these programs.

<sup>b</sup>As submitted to Congress, September 1981.

<sup>c</sup>Omnibus Reconciliation Act of 1981 (Public Law 97-35).

<sup>d</sup>Appropriations bill approved by conference committee, Nov. 4, 1981. Includes new budget authority and deferrals and transfers from 1981

SOURCES: Energy Conservation and Power Subcommittee of the House Energy and Commerce Committee; Housing Subcommittee of the House Banking, Housing, and Urban Affairs Committee; and the Office of Technology Assessment

community Development Block Grant (CDBG) Program. However, the deeper cuts required for the 1983 budget may affect the Community Development Action Grant Program.

This section briefly describes the Federal programs in two categories: 1) information and marketing of building retrofit, and 2) financial assistance to energy retrofit and housing rehabilitation. Chapter 5 has a brief description of two other important Federal programs, low-income energy assistance and weatherization.

No attempt is made to relate the description of the Federal energy conservation programs to cities since they have been designed to apply nationwide across urban boundaries. However, such programs can be used by city governments in programs specifically focused on urban buildings. Federal housing rehabilitation and urban development programs, on the other hand, are specifically tailored to cities.

### Information and Marketing of Building Retrofit

The most ambitious of the Federal marketing and information programs is the *Residential Conservation Service* (RCS), established in 1978 under title II of the National Energy Conservation Policy Act; \$15 million was authorized by Congress for fiscal years 1979, 1980, and 1981; \$40 million was authorized for audit training for fiscal 1980 and 1981.

According to regulations currently in effect (issued Nov. 7, 1979) the heart of the Residential Conservation Program is the requirement that all public utilities whose rates are regulated by a State regulatory authority promote and distribute information to residential customers about the availability of audits, the cost of purchase and installation of certain energy devices, and the potential savings from retrofit actions. The utility must also offer audits to all customers who own or occupy buildings of one to four units. Audits are usually "class A," which means an auditor inspects the building, although in some cases a do-it-yourself audit, called "class B," is used. The utility must arrange for financing, as part of the program, and can either make loans itself or maintain a list of

banks willing to provide conservation loans. Similarly, the utility must maintain an approved list of contractors to perform retrofits (usually certified by the State). The program is administered at the State level, by a lead agency designated by the governor. This agency formulates a plan for the RCS program and ensures compliance with the plan.

The regulations governing the RCS would be made far more flexible under a "Notice of Proposed Rulemaking" recently issued for comment by the public. Utilities would be given far more leeway in determining the measures to be considered in an onsite audit and they would not be required to provide onsite audits, to arrange financing, or provide a list of contractors.<sup>1</sup>

About 65 utilities offered audits before the RCS program was mandated and many of these are likely to continue to do so, even if the programs were withdrawn. To date, more than 40 States and territories have announced their own RCS programs. More than 70 utilities now have audit programs underway; 80 percent of these offer financing; 75 percent supply at least one energy-efficient device (such as flow restrictors or heat pumps), and so percent provide assistance in finding a contractor to do the retrofit. The number of audits available to utility customers has quadrupled since 1977-78 just before the program began.<sup>2</sup>

According to one evaluation of 35 utility audit programs (including many formed prior to RCS), most programs had not reached more than 5 percent of their customers since their start. Four reported that more than 10 percent of their eligible customers had requested audits. Audit programs with larger response rates tended to: 1) be older which improved the word-of-mouth reputation of the program, 2) offer audits on evenings and weekends, 3) greatly simplify the process of requesting an audit, and 4) coordinate advertising closely with seasonal anticipation of high energy bills.<sup>3</sup> Additional informa-

<sup>1</sup>"Residential Conservation Service Program," proposed rules. *Federal Register*, vol. 46, No. 218, Nov. 12, 1981.

<sup>2</sup>"DOE Compiles Information on State of RCS," *Energy Conservation Digest* Vol. V, No. 1, Jan. 4, 1982.

<sup>3</sup>Eric Hirst, Linda Berry, and Jon Soderstrom, "Review of Utility Home Energy Audit Programs," *Energy*, vol. 6, No. 7, pp. 621-630, Great Britain 1981.

tion on utility audit programs can be found in chapter 8 on "The Role of Utilities."

To date the RCS approach has not been officially extended to commercial or multifamily buildings. Under a proposed rule issued in February 1981, DOE proposed the creation of a Commercial and Apartment Conservation Service (CACS).<sup>4</sup> The proposed CACS rule was amended in the RCS proposed rule published November 12, 1981, and the status of the program is still unclear. Under the original proposed CACS rule, tenants in individually heated and cooled apartments, owners of centrally heated and cooled apartments, and tenants and owners of small commercial buildings would be eligible customers for the audit service. Owners could request the present RCS audit and receive the related services and arranged financing, or alternatively, the owner could request the specially designed CACS audit. This audit, as proposed, would be designed for building owners and would not include the additional services. Commercial buildings used for business, government, and nonprofit activities would also be eligible for CACS audits, but up to specified limits on monthly energy usage (less than 4,000 kilowatt hours of electricity or 1,000 therms of natural gas).

Another Federal program to stimulate building retrofits is officially called the Institutional Conservation Program, but is often referred to as the "Schools and Hospitals Program" in recognition of the categories of buildings that are its biggest beneficiaries. The program provides grants for energy audits for schools, hospitals, local government buildings, and public care institutions. Schools and hospitals are also eligible for grants to subsidize capital investments in energy efficiency; the other two building categories are not eligible.

As of February 1981, about \$260 million had been obligated for institutional building grants and about 8,000 individual grants had been issued. According to a preliminary evaluation for DOE, a far greater share of hospitals (25 per-

cent) and schools (16 percent) had taken advantage of the audit grants than had local government buildings (3 percent) or public care institutions (8 percent). According to the evaluation, the opportunity for a capital investment grant provides stimulus to undertake operational improvements in energy efficiency and to make low-cost investments.<sup>5</sup>

The evaluation cites anecdotal evidence that the program has stimulated retrofit among private buildings not eligible for the program. The provision of technical assistance to local energy officials and local architects, engineers, and energy auditors proved to be one of the unexpected tasks of the program. As a side-effect, the program has stimulated the development of a professional community of energy auditors and helped them build professional reputations in their communities. In at least one case study visited by OTA, schools and hospitals work was helping to expand the list of completed retrofits for local engineers, and contribute to their reputation for success.

There are several other small but significant Federal information programs to stimulate energy retrofit. One of these is the testing of energy retrofit measures at the national laboratories. The Brookhaven analyses of the impact of boiler retrofits, for example, are the standard references for energy auditors seeking information about such devices as stack heat reclaimers or modulating aquastats and were used for the retrofit analysis in chapter 3. There is a small Federal conservation program to develop the market for energy retrofits. A grant under this program funded the retrofit of six prototypical hotels and motels in several different climates. The results will be disseminated to members by the American Hotel & Motel Association (this project was discussed further in ch. 4). Finally, there is the Energy Extension Service (EES) created by title V of the Energy Research Act of 1978. EES is State run and usually administered through the State university system. Generally, EES promotes energy retrofit through

<sup>4</sup>Department of Energy, "Commercial and Apartment Conservation Source (CACS) Program, Proposed Rule," 10 CFR, Part 458, *Federal Register*, vol. 46, No. 11, Jan. 16, 1981, p. 4482.

<sup>5</sup>"Status and Performance of the Institutional Conservation Program: An Interim Report," draft report prepared by the Synectics Group, Inc., for the Department of Energy under contract No. ACO1-80-CS64999.

person-to-person communication via workshops, hotlines, and shopping center booths. An evaluation of the program in the initial 10 pilot States found that audits, counseling and technical assistance were most successful in inducing retrofit actions and that small businessmen, as a category, took the most followup actions as a result of EES contact.<sup>6</sup>

## Financing

Federal financial assistance to building retrofit comes in two major forms: energy tax credits, and financial assistance of several kinds to housing rehabilitation. A third form, direct subsidies to retrofit under the Solar and Conservation Bank, was legislated but has not been implemented. The Federal Government also permits and encourages utility financing and financing assistance to retrofit under the RCS and provides financing of retrofit under the Institutional Conservation Program described above.

**Tax Credits.** The most far-reaching of the Federal financing programs is the Residential Energy Tax Credit. Owners or occupants of buildings with up to four dwelling units may claim up to 15 percent tax credit on an energy efficiency retrofit up to a ceiling of \$2,000. The maximum credit is thus \$300 per income tax return. For renewable retrofits the ceiling is much higher, \$2,500 maximum tax credit.

In 1978, when the program covered more than a year and a half of retrofits (from April 1977 through December 1978), almost 6 million taxpayers took advantage of the credit to make more than \$4 billion of energy retrofit expenditures. The total amount claimed for the credits has been about \$560 million. By 1979, partly because the program only covered a year of retrofits instead of 20 months, participation had fallen somewhat to about 4.8 million taxpayers making about \$3.5 billion of retrofit investments and claiming about \$440 million in tax credits. Even at its lower 1979 level, the program

<sup>6</sup>See *Energy Extension Source Pilot Program, Evaluation Report After Two Years*, vol. 1: "Evaluation Summary" and vol. II: "State Reports, ICF & WESTAT," for DOE, Washington, D. C., April 1980. Also see *Comprehensive Program and Plan For Federal Energy Education Extension and Information Activities*, DOE, March 1980, p. 15-3.

reached more than five times as many households as have been affected by 6 years of Federal housing rehabilitation programs (see table 83).

The outstanding characteristic of the energy tax credit program is that middle and upper-income taxpayers respond in fairly high proportion while lower-income taxpayers hardly respond at all. Table 80 shows the response rate by income class for both the 1978 and 1979 returns. For the approximately 40 million taxpayers with adjusted gross incomes less than \$10,000 per year, an average of 1 percent in both years took advantage of the residential energy tax credit. One obvious problem for the lower-income taxpayers is that they don't pay enough income tax to be able to take advantage of the credit. One out of four of the small fraction of taxpayers who did claim the credit had to carry the credit over into another year to take full advantage of it.

On the other hand, middle and upper income taxpayers responded in large numbers to the tax credit in both 1978 and 1979, more than 16 percent of the 22 million taxpayers with adjusted gross incomes over \$20,000 in 1978 and more than 12 percent of the 26 million in this income class in 1979. Compared to the typical response rates of less than 5 percent to most utility audit programs, these are very large rates indeed.

**Table 80.—Response to Energy Tax Credits by Income Class, 1978 and 1979**

| Adjusted gross family income class | Total number of returns | Percent of returns requesting energy tax credits |
|------------------------------------|-------------------------|--|
| <b>1978 returns<sup>a</sup></b>    |                         |  |
| More than \$20,000 . . .           | 22,300,000              | 16.5%  |
| \$15,000 to \$19,999 . . .         | 11,400,000              | 9.8  |
| \$10,000 to \$14,999 . . .         | 14,250,000              | 4.5  |
| Less than \$10,000 . . .           | 39,900,000              | 1.2  |
| <b>1979 returns</b>                |                         |  |
| More than \$30,000 . . .           | 10,986,000              | 14.3   |
| \$20,000 to \$30,000 . . .         | 15,323,000              | 10.8   |
| \$14,000 to \$20,000 . . .         | 13,954,000              | 6.5  |
| \$10,000 to \$14,000 . . .         | 11,863,000              |  |
| Less than \$10,000 . . .           | 40,485,000              | 0.9  |

<sup>a</sup>The 1978 tax returns covered almost 2 years of retrofits from April 1977 to December 1978.

SOURCES: Department of the Treasury, Congressional Research Service, and the Office of Technology Assessment.

The average retrofit expenditure for which a tax credit was claimed was over \$700 in each year. More than half of all taxpayers in 1978 used the credit for storm windows or doors and more than 60 percent used it for insulation (see table 81). For about two-thirds of the taxpayers the size of the energy credit was less than \$100 (see table 82). For these taxpayers, the amount expended was therefore less than \$666. overall,

it can be concluded that the energy tax credit reached a large share of middle and upper income households and stimulated at least some of them to spend modest amounts on energy retrofits. (Others would have retrofit anyway without the tax credit. ) One important side benefit of the tax credit program is that it provides excellent information on retrofits carried out by single-family homeowners.

**Table 81.—Use of Residential Energy Tax Credits for Energy Conservation and Renewable Retrofits, 1978**

|                                       | Number of returns      | Percent of total   | Amount expended | Average expenditure |
|---------------------------------------|------------------------|--------------------|-----------------|---------------------|
| Total returns . . . . .               | 5,940,169 <sup>a</sup> | —                  | \$4,205,636,000 | 708.                |
| Total principal residences . . . . .  | 5,941,419              | —                  |                 |                     |
| Total energy conservation . . . . .   | 5,900,788              | 100.0 <sup>b</sup> | 4,090,096,000   | 693.                |
| Type energy conservation:             |                        |                    |                 |                     |
| Insulation . . . . .                  | 3,933,123              | 66.7               | 1,758,727,000   | 447.                |
| Storm windows or doors . . . . .      | 3,342,373              | 56.6               | 1,790,437,000   | 536.                |
| Caulking . . . . .                    | 2,559,906              | 26.4               | 87,424,000      | 56.                 |
| Other . . . . .                       | 826,463                | 14.0               | 453,509,000     | 548.                |
| Energy conservation credits . . . . . | 5,900,788              | —                  | 557,540,000     | 95.                 |
| Total renewable sources: . . . . .    | 68,102                 | 100.0              | 115,540,000     | 1,697.              |
| Type renewable source:                |                        |                    |                 |                     |
| Solar energy . . . . .                | 56,643                 | 83.3               | 110,798,000     | 1,956.              |
| Geothermal . . . . .                  | 1,736                  | 2.6                | 3,142,000       | 1,810.              |
| Wind energy . . . . .                 | 10,395                 | 15.3               | 1,600,000       | 154.                |
| Renewable resource credits . . . . .  | 68,102                 | —                  | \$ 30,119,000   | —                   |

<sup>a</sup>Total doesn't equal sum of conservation and renewable returns because one return could claim both conservation and renewable credits and would be counted twice in disaggregate form  
<sup>b</sup>D\_s not add up to 100 percent because more than one measure can be claimed on one return.  
<sup>c</sup>The energy credit is 15 percent of this amount.

SOURCE: Internal Revenue Service Preliminary Report, Statistics of income-1978, Individual Income Tax Returns, Washington, D.C., 1980, p. 42.

**Table 82.—Distribution of Residential Energy Tax Credits by Amount of Credit, 1978**

| Size of credit               | Residential energy credits <sup>a</sup> |                  |               |                  |
|------------------------------|---|------------------|---------------|------------------|
|                              | Number of returns                       | Percent of total | Amount        | Percent of total |
| \$ 1 under \$ 100, . . . . . | 3,971,531                               | 66.9             | \$178,755,000 | 30.4             |
| 100 200 . . . . .            | 1,105,628                               | 18.6             | 153,357,000   | 26.1             |
| 200 300 . . . . .            | 394,979                                 | 6.6              | 96,727,000    | 16.5             |
| 300 400 . . . . .            | 435,137                                 | 7.3              | 130,803,000   | 22.2             |
| 400 500 . . . . .            | 5,830                                   | 0.0              | 2,598,000     | 0.4              |
| 500 1,000 . . . . .          | 20,384                                  | 0.3              | 15,181,000    | 2.6              |
| 1,000 1,500 . . . . .        | 3,788                                   | 0                | 4,345,000     | 0.7              |
| 1,500 2,000 . . . . .        | 665                                     | 0                | 1,094,000     | 0.2              |
| 2,000 2,200 . . . . .        | 564                                     | 0                | 1,175,000     | 0.2              |
| 2,200 2,500 . . . . .        | 1,502                                   | 0                | 3,546,000     | 0.6              |
| 2,500 + . . . . .            | 161                                     | 0                | 403,000       | 0                |
| Total . . . . .              | 5,940,169                               |                  | \$587,984,000 |                  |

<sup>a</sup>Total credits claimed in a year regardless of the limitation relative to tax liability and resultant CarryOver of credits.

SOURCE: Internal Revenue Service Preliminary Report, Statistics of income-1978, Individual Income Tax Returns, Washington, D.C., 1980, p. 6.

Tax credits have in practice not been available to multifamily buildings and only the investment tax credit has been available to most commercial buildings. The relevant credits are the business energy tax credit, authorized by the Energy Tax Act of 1978 (Public Law 95-618) and the investment tax credit (Public Law 95-600 and Public Law 95-618). Enacted to encourage general investment in capital equipment by business, the investment tax credit provides a 10 percent credit against the tax liability of a commercial enterprise. Investments qualifying for the credit must be "nonstructural," and such investments are not allowed for hotels, or for any structure housing "primarily permanent residents." Thus, the investment tax credit is clearly not available for investments in multifamily properties, or for the many types of envelope retrofits that might be indicated for certain structures.

Given the restrictions on the investment tax credit, much hope was placed on the business energy tax credit as a method for accelerating energy retrofit in commercial properties. Structural retrofits are eligible items under the business energy tax credit. The property must be depreciable and must have a useful life of 3 years or more. Like the investment tax credit, the credit can run back 3 years or forward 7, and unlike the investment tax credit, the energy credit can erase 100 percent of a business' tax liability.

Substantial problems developed in the promulgation of regulations for the energy credit. First, the regulations declared that the credit would be available only to those enterprises engaged in commerce "as a means or method of producing a desired result by chemical, physical, or mechanical action." This definition of industrial or commercial process effectively eliminated most retail sales applications, restaurants, and other nonindustrial businesses.

Secondly, the Internal Revenue Service limited the credit to certain specifically defined energy property. These properties are the type normally used by large industrial concerns. They are recuperator, heat wheel, regenerator, heat exchanger, waste heat boiler, heat pipe, automatic energy control system, turbolator,

preheater, combustible gas recovery system, and economizer. A final regulatory impediment to application of the credit is that credit is limited to that portion of the cost of the equipment that can be directly attributed to the conservation function; in other words, the portion of the equipment that performs any function other than conservation may not be qualified. The net effect of the regulations is that the business energy tax credit is essentially nonexistent for most retail businesses, and for multifamily structures.

**Housing Rehabilitation Programs.** Housing rehabilitation programs operated by HUD stimulated as a group major property improvement investments for about 850,000 dwelling units between 1975 and 1980 (see table 83). The largest of these programs is the CDBG program. Others are named after the sections of law which created them, section 312, section 8, and sections 221 d(3) and 221 d(4). The total volume of dwelling units rehabilitated under the latter three programs was less than a quarter of the number rehabilitated under CDBG from 1975 to 1979. These rehabilitation programs provide money for many aspects of housing improvement, only incidentally including energy efficiency improvements. Top priority usually goes to correction of building code violations that threaten health and safety, such as wiring deficiencies, structural weaknesses, or plumbing inadequacy. Basic energy efficiency measures, however, such as storm windows, insulation, and upgraded heating systems are also included in rehabilitation packages.

**Table 83.—Dwelling Units Rehabilitated Under Four Federal Housing Rehabilitation Programs, 1975-80**

| Fiscal year               | Rehabilitation programs <sup>a</sup> |                      |           |                      |
|---------------------------|--------------------------------------|----------------------|-----------|----------------------|
|                           | Section 312                          | CDBG                 | Section 8 | Section 221d3 and d4 |
| 1975 . . . . .            | 6,041                                | 66,000               | —         | 889                  |
| 1976 . . . . .            | 6,918                                | 90,000               | 3,723     | 2,557                |
| 1977 . . . . .            | 8,718                                | 103,000              | 12,901    | 5,694                |
| 1978 . . . . .            | 7,309                                | 123,810              | 19,436    | 8,268                |
| 1979 . . . . .            | 16,500                               | 170,896              | 26,562    | 8,201                |
| 1980 . . . . .            | —                                    | 220,000 <sup>b</sup> | —         | —                    |
| Total (1975-80) . . . . . | 100,000 <sup>b</sup>                 | 753,700              | —         | —                    |
| Total (1975-79) . . . . . | 45,486                               | 533,706              | 62,622    | 25,609               |

<sup>a</sup>Fiscal year 1975-79 data from Annual Report to Congress on Section 312 Rehabilitation Loan Program.

<sup>b</sup>Estimates from J. Kossy, HUD

SOURCES Office of Technology Assessment

Title I of the Housing and Community Development Act of 1974 as amended, established CDBG to eliminate slums and blight, assist low- and moderate-income persons, and respond to urgent local needs. Over 1,500 localities throughout the Nation have used CDBG funds for property rehabilitation. Many use these public funds to establish leveraged loan pools in conjunction with private lenders. The Housing Act and Community Development Amendments of 1980 provided specific authority for use of CDBG for loans for energy conservation improvements in rehabilitation housing. To date, CDBG funds have been made available in most cities primarily to owner-occupied buildings of up to four dwelling units. Large multifamily buildings have, by and large, not been affected by the program. An effort to expand the program to multifamily buildings is now underway in HUD. A pilot program in about 25 cities will provide CDBG subsidies to financial institutions who will in turn make medium-term (5 to 7 year) loans at subsidized interest rates to multifamily building owners. A little used HUD program to provide property improvement loan guarantees for multifamily buildings (title Ib) will be used to encourage banks to make longer term loans on multifamily properties.<sup>8</sup>

Although energy conservation improvements are encouraged under CDBG there is no comprehensive data on the number of communities that are using CDBG specifically for retrofit. Two large CDBG retrofit programs, Boston and Pittsburgh, are described in the case studies in chapter 10. Both cities shifted from a comprehensive rehabilitation program to programs aimed primarily at retrofit.

Several other smaller more specialized rehabilitation programs have been available to finance retrofit although they are scheduled to be phased out in the 1983-84 budget reductions. The section 312 loan program provides direct low-interest, long-term loans to property owners in approved areas, to finance or refi-

nance rehabilitation in residential, nonresidential, and mix-used properties according to applicable urban renewal property rehabilitation standards. Loans are limited to \$27,000 per single-family unit and \$100,000 for nonresidential properties and can be repaid over 20 years at 3 percent interest. Low and middle income families receive priority. Rehabilitation financed by section 312 is required to include cost-effective energy efficiency retrofits along with other types of property improvements.<sup>9</sup> Section 8 for existing buildings is a program to provide subsidies to owners who are rehabilitating their existing buildings and will then rent them to low-income families.<sup>10</sup> Section 8 also requires cost-effective energy improvements. The section 221d(3) and 221d(4) programs authorize rehabilitation for low- and moderate-income housing originally financed with Federal Housing Administration mortgages.<sup>11</sup> They do not have explicit retrofit requirements. Another program aimed at multifamily rehabilitation is section 241 of the Housing and Community Development Act of 1968 (Public Law 90-448) which authorized FHA insurance multifamily projects.<sup>12</sup> In 1979, Housing Act amendments provided that HUD could insure a loan under section 241 for purchasing and installing conservation measures, solar energy systems and purchasing or installing (or both) individual utility meters in a multifamily housing project.

The Federal Government has traditionally encouraged longer term financing for housing through the creation of a secondary market for mortgage loans. The Federal Home Loan Mortgage Corporation (known as Freddie Mac) purchases mortgage-backed securities from banks and in turn sells these to large financial institutions such as insurance companies and pension funds. In the winter of 1981, Freddie Mac issued guidelines for a pilot program to purchase home improvement loans for single-family homes

<sup>9</sup>Sec. 312 of the Housing Act of 1964.

<sup>10</sup>Sec. 8 was authorized in the Housing and Community Development Act of 1974 as part of the renumbered U.S. Housing Act of 1937.

<sup>11</sup>Secs. 221 d(3) and 221 d(4) are of the National Housing Act of 1934. They were created by Section 101a of the Housing Act of 1961.

<sup>12</sup>Housing and Community Development Act of 1968, Public Law 90-448, sec. 241.

<sup>7</sup>Housing and Community Development Act of 1974, title I, sec. 105(a)(4), as amended by the Housing and Community Development Act of 1980.

<sup>8</sup>Presentation by Michael Ehrman, HUD, at a Community Energy Workshop meeting held at HUD on Oct. 29, 1981, and sponsored by the Center for Renewable Resources.



from savings and loan associations. The loan amounts may run as high as \$30,000 and the loan term as long as 75 years. They must be secured by a second trust. There are no plans to create a secondary market for property improvement loans for multifamily or commercial buildings.<sup>13</sup>

**Solar and Conservation Bank.** The formation of a solar and conservation bank (to be established within HUD) was authorized in title V of the Energy Security Act of 1980 (Public Law 96-299). The intended purpose of the bank was to provide subsidized loans for investments in energy conservation and renewable to low-income homeowners, multifamily building owners and owners of buildings used for small businesses (defined as businesses with gross receipts under \$1 million).

A budget appropriation of \$121 million was made for the bank in fiscal year 1981, but regulations were not formally issued before the Reagan administration requested that funding for the bank be eliminated from the 1982 budget. In the Omnibus Reconciliation Act of 1981, Congress restored \$50 million and also included it in appropriations for fiscal year 1982. However, no official regulations have officially been issued. As proposed in preliminary regulations sent to Congress for approval in the winter of 1981, the bank would have provided subsidies in the form of lump-sum grants to lending institutions for eligible loans. The lending institution would then use the grant to reduce the interest rate over the term of the loan. Had the bank remained at a funding level of several hundred million dollars, it would be a considerably smaller program than the CDBG rehab program of nearly \$1 billion per year.

**Urban Development Action Grants (UDAGs).**<sup>14</sup> These grants are used to leverage private investment to assist distressed cities and

urban counties to strengthen their economic base. HUD has launched a demonstration program in six cities including Trenton, N. J., Rochester, N. Y., and St. Paul, Minn., to subsidize interest rates loans for energy conservation from private lending institutions. In the first of these cities, Springfield, Mass., the housing authority and private lending institutions have used their funds to provide a \$1.2 million loan pool.

### Summary: Impact of Federal Programs on Building Retrofit

Federal programs have reached, in one way or another, a large fraction of the single-family homeowners and small multifamily owner-occupants in this country. Through the tax credit information we know that a large fraction have actually made modest investments in energy retrofit. To date, Federal programs have not much affected owners of multifamily or commercial buildings. The programs, which were intended to assist such owners, the Solar and Conservation Bank and the Commercial and Apartment Conservation Service, have, respectively, gone unfunded or have not yet been implemented.

Several Federal programs provide a framework within which State and local programs to stimulate building retrofit can be developed. Some possibilities for State and local tailoring of Federal programs is described in chapter 10. The most flexible of the Federal programs for this purpose are CDBGs and UDAGs which are designed to complement individual local responses. Under its original regulations, the RCS program, was fairly standard from State to State although individual States certainly developed unique approaches to RCS. If the currently proposed regulations are adopted, the RCS regulations will permit States considerably more leeway to shape their own programs.

<sup>13</sup> Presentation by Mark Shaefer of the Federal Home Loan Mortgage Corporation at a community energy workshop meeting held at HUD on Oct. 29, 1981.

<sup>14</sup> Authorized in the Housing and Community Development Act

of 1977. See Department of Housing and Urban Development, "Community Development Block Grant, Clarifications and Change to Urban Development Action Grant, Proposed Rule," *Federal Register*, vol 45, No. 93, May 12, 1980.

## ROLE OF STATE GOVERNMENTS

The State government influence on the retrofit of buildings in cities is indirect but can be powerful. All States regulate public utilities and distribute Federal funds for weatherization and low-income energy assistance. Some States have direct authority or substantial influence over local building codes and some States have important housing finance programs or energy tax credits.

Motivation for an active State role in developing building retrofit and other energy conservation programs can come from any number of perceived energy problems. Regardless of the category of problem, some States will be led by State officials to take action while neighboring States with similar problems do relatively little. Florida and California represent one category of problem that has prompted some State officials to take action. Although their climates are mild compared to Northern States, both are States with rapidly growing populations and noticeable strains on peak electric capacity. In both States it is not unrealistic to expect rapid increases in the prices of both electricity and natural gas. State officials are faced with difficult decisions on how to accommodate rapid growth in electric power. In both States it is relatively difficult to find sites for new powerplants. Such concerns have led State officials to develop several far-reaching energy conservation programs with considerable impact on the retrofit of buildings, inside and outside cities.

Minnesota, Massachusetts, New York, Pennsylvania, and other Northern States represent quite a different set of energy problems, which has also stimulated the development of substantial energy programs. population in these States is growing slowly. Electric utilities are not required to add new generating capacity. Some are expected to be over capacity for quite some time. On the other hand, winters are severe in all these States. Individual cities in all of them except Minnesota are heavily dependent on expensive fuel oil to heat homes. In all these States there is reason to be concerned about excessive hardship for low-income people and about ero-

sion of the multifamily housing stock from the strain of providing adequate heat.

The most important State influence on building retrofit is probably through the regulation of utilities, followed in importance by building codes, allocation of Federal funds and State financing.

### Regulation of Investor-Owned Utilities

All States regulate the rates and usually the generating capacity plans of investor-owned utilities. In this capacity, a few States have developed explicit criteria for linking the development of utility conservation programs to approval of their electricity-generating plans.

The Florida State Public Service Commission (**PSC**) has adopted tough rules to reduce growth rates in electric consumption and the dependence on oil as a generating fuel. The PSC will review proposed rate increases against a utility's conservation record and conservation will be measured as an alternative to new plant construction as a means of "increasing capacity." The State public utility commission (PUC) sets limits on demand growth for each utility, but how the company meets these growth limits is its own business. In the case of the Tampa Electric Co. (TECO), energy will be allowed to grow at 85 percent of TECO's customer growth rate and demand at 85 percent of that. TECO will be offering RCS audits to about 2,000 homes a year, but the company feels that the most promising route to meet the State requirement is by encouraging less energy use in new residential construction, as this is where most of the growth in demand is expected. As a result, TECO will subsidize installation costs of electric heat pumps and more efficient electric water heaters to the majority of new homes in its service area.<sup>15</sup>

The California PUC also evaluates a utility's conservation efforts when it considers rate in-

<sup>15</sup>The Florida public Utility Commission regulations and their impact on TECO are described in greater detail in the Tampa case study.

crease **proposals. This is part of the State's** overall energy philosophy that conservation itself is an energy resource, just as oil and gas are. All of the State's utilities now provide below market rate financing for insulation and interest-free loans for weatherization. [In response to the weatherization requirement, Pacific Gas & Electric, the State's largest utility set up the ZIP (Zero Interest Plan) program. Under the ZIP program, the utility will offer free audits to any residential customer and interest-free loans for certain energy saving measures, especially insulation. The State's four largest utilities have been ordered by the PUC to begin a 3-year program in which utilities will offer up to \$960 in cash rebates and low-interest loans to 375,000 homeowners and landlords for the purchase of solar hot water heaters.<sup>16</sup>

A much larger number of States have developed residential conservation service programs under the November 1979 regulations described above. Programs of audits and retrofit services had been announced in 25 of the 41 participating States (including Puerto Rico) as of August 1981. Several States have developed innovative programs even within the fairly stringent Federal guidelines. Massachusetts has created a third party corporation, Mass-Save Inc., to operate the program. Most of Massachusetts' 59 utilities, (including municipal utilities) have contracted with Mass-Save to provide audits and retrofit services to their customers. As of January 1982, 64,000 audits had been conducted.<sup>17</sup> Massachusetts plans to expand the audit program to all multifamily buildings and commercial buildings regardless of the fate of the Federal CACS program. New York State passed the Home Energy Improvement and Conservation Act (HEICA) program in 1977 before the Federal RCS program was launched and later incorporated it into the New York RCS program. The HEICA program requires all utilities in the State to offer audits to customers and also to subsidize retrofit loans through local lending institutions down to the utilities own

borrowing rate. In OTA's case study city of Buffalo, N. Y., both local utilities, National Fuel Gas and Niagara Mohawk, offered HEICA loans.

## Building Codes

States vary greatly in the extent to which they have any jurisdiction over local building codes. About 42 States have adopted some form of statewide building code, including a statewide energy code. However, in only five of these does the State code prevail such that it cannot be amended locally. Five other States have statewide building codes that can be amended locally. Four States have adopted model State codes which are available, but not mandatory, for local adoption.<sup>18</sup>

States do not have to have a mandatory statewide building code **in order to mandate energy efficiency standards** for new buildings. Florida, discussed below, is an example of a State with mandatory energy efficiency standards but no statewide general building code. As of January 1979, 37 States had some authority to adopt and implement energy conservation standards for some or all types of new buildings. Of these, 30 have authority for all new buildings while 7 have more limited authority.<sup>19</sup>

Most States have adopted the energy efficiency standard recommended by the American Society of Heating, Refrigeration & Air-conditioning Engineers (ASHRAE).

A few States, however, have created their own standards for new buildings. The most innovative of these is probably Florida where a statewide Model Energy Efficiency Code went into effect on October 1, 1980. The code assigns energy points to each energy consuming feature of the building on a graduated scale, so the less

<sup>16</sup>Sources for this information are conversations with officials at the National Conference of States on Building Codes and Standards (NCSBCS) and with William Connolly, New Jersey Department of Community Affairs. The five States with mandatory non-amendable codes are: Massachusetts, New Jersey, Virginia, Wisconsin, and Connecticut. The five with mandatory amendable codes are: Michigan, Minnesota, North Carolina, Kentucky, and Oregon. The four States with model building codes are: New York, Ohio, Georgia, and Indiana.

<sup>19</sup>*States Energy Conservation Standards for Buildings: Status of States' Regulatory Activities*. Published by the National Institute of Building Sciences, Washington, D. C., 1979.

<sup>16</sup>Save Energy, California Energy Commission, issue No. 3, fall quarter, 1980, p. 1.

<sup>17</sup>Massachusetts State government, Residential Conservation Service (factsheet), pp. 1-3. Interview with Carl Bittenbender, Mass-Save, February 1982.

energy a building uses, the lower its total score.<sup>20</sup> The code applies to all new buildings, additions, and structures where renovation accounts for 30 percent of the building's value or more. California has adopted energy efficient standards for new buildings and appliances and also runs an extensive program to train local building inspectors.<sup>21</sup>

Home rule tradition is a major reason why more statewide building codes (and energy efficient provisions) have not been enacted. Building codes are a jealously guarded local prerogative and there is usually resistance from both local officials and local builders to State codes. For new buildings, the less proscriptive the code, the more likely it is to be accepted. In Florida, for example, local homebuilders have been receptive to the State code because it does allow considerable flexibility in how standards are met.

Energy efficiency codes for new buildings have an impact on the retrofit of existing buildings in two ways. They affect the competitive climate for existing buildings by ensuring that new buildings are fairly energy efficient and thus fairly inexpensive for tenants who must pay their own utilities. In OTA's case study of Tampa, the influence of the Florida code was cited as an extra source of pressure on owners of existing buildings to retrofit. Energy efficiency codes for new buildings, especially one such as Florida's which gives builders a lot of choices, also help publicize the technical options for improved energy efficiency and help to lower the perceived risk of retrofit.

Minnesota is the only State to promulgate energy efficiency requirements for existing buildings. Under the State mandatory energy conversion standards for rental housing, all units must be weatherstripped by January 1, 1981, and must have other energy saving features (e.g., storm doors and windows, R-19 attic insulation) by July 1, 1983. Enforcement of the ordinance is by tenant complaint. No data is available on compliance. Under the State mandatory energy disclosure audit at time of sale

<sup>20</sup>*Shining Examples: Model Projects for Using Renewable Resources*, Center for Renewable Resources, 1980, p. 28.

<sup>21</sup>California Energy Commission, Op. cit., p. 55.

provisions, new owners must be told if the unit meets State audit standards. All residential units are covered by this provision and auditors must be approved by the State building code division. Through its Housing Finance Agency, Minnesota also offers low interest home improvement loans to moderate-income homeowners and owners of rental buildings. The loans can be used specifically for energy and general home improvements and are designed to reach 1 to 6 unit structures. The income limitations have been sufficiently restrictive however so that few rental properties have been involved.\*\* Such financing is available to the property owner but is not formally tied to the code inspection process.

### Allocating Federal Funds

States serve as the conduits for two Federal programs designed to help low-income households cope with high energy prices. Both of these programs, weatherization and low-income energy assistance are described in chapter 5.

For both programs, States provide overall planning and management and allocate funds to local government. Under current weatherization formulas which give heavy weight to heating degree days, the dilemma for Southern States such as Florida and Texas has been how to fairly spread around a small amount of funds. The Texas weatherization allotment would permit little more than 5,000 units per year. Low-income energy assistance funds within Texas have also favored counties with colder climates.<sup>23</sup> In OTA's case study city of San Antonio, officials found themselves at a disadvantage vis-a-vis other Texas cities in getting energy assistance funds to pay air-conditioning costs for elderly residents who are threatened by heat stroke.

Pennsylvania is one of few States that have been outstanding in the effective management

<sup>22</sup>Proceeding of the Multifamily Housing Workshop, Dec. 4-6, 1980, Deborah L. Bleviss, Federation of American Scientists.

<sup>23</sup>Interview with Joan Cappolino, Florida Department of Health and Rehabilitative Services. Texas State Plan for Weatherization Assistance for Low-Income Persons, draft plan, October 1980, Texas Department of Community Affairs (TDCA), and interview with John Geistweidt of TDCA.

of the weatherization program to retrofit the dwelling units of low-income households. Pennsylvania's program dates from 1976, when the State funded the program on its own. Weatherization is run through the State department of community affairs, which has set high production goals. Each year, about 14,000 homes are weatherized, at a level of about 1,200 to 1,400 homes a month—more than double any other State. Furthermore, the Pennsylvania program has tried to address rental and multifamily units to a greater degree than other State weatherization programs. About 20 percent of the single-family homes weatherized in 1979 were renter occupied. The State has also tried to direct weatherization funds to buildings of five or more units, especially public housing.<sup>24</sup>

Very few States have effectively coordinated weatherization with energy assistance although there is usually some mechanism for referring households from one to the other. The programs are usually run out of different State departments. Weatherization is likely to be run through a community affairs department because it is administered through community action program (CAP) agencies. Low-income energy assistance is usually treated as an income maintenance program and managed out of a State welfare or human resources department and distributed out of community welfare offices (see fig. 57).

### Financing

States can help finance energy conservation programs in two ways—through State subsidy programs and through tax incentives. Many States now have housing finance agencies that provide mortgage subsidies and low interest rate financing. A few of these programs are now being directed toward energy conservation. The New Jersey Mortgage Finance Agency has offered 83A-percent interest loans for solar hot water heaters and other energy conservation improvements, under an experimental program. Up to \$3,000 was allowed under the pilot

for the purchase and installation of solar units and another \$1,500 for other improvements, with a maximum loan term of 15 years. In an evaluation of the program, most participants took advantage of the full loan terms and indicated that they would not have installed solar units without the incentive. Furthermore, most participants (71 percent) had incomes of \$40,000 or less.<sup>25</sup> The Minnesota Housing Finance Agency also offers low interest loans (described above) for energy conservation and general home improvement to owner occupants of one-to six-unit buildings. A special rental improvement demonstration program provides below-market interest rates to owners of rental properties occupied by low-income tenants.<sup>26</sup>

Through its taxing authority, a State can provide considerable incentive for energy conservation. The best known example of the use of the tax power is California's 55-percent tax credit on passive and active solar systems. Nearly 30,000 such credits were claimed in California in 1978, with a total subsidy of \$25 million. The California subsidy, which can be taken on top of the Federal credit, reduces the cost of such units to \$1,200 to \$1,500 and the payback to 3 years.<sup>27</sup> California is now trying a 40 percent tax credit for conservation to qualified audits. In Oregon, tax credits are offered for weatherization and for installation of alternate energy sources.<sup>28</sup>

States may also provide enabling legislation for city tax incentive for energy conservation and renewable. New York State's J-51 program that allows cities to permit tax abatements for rehabilitation has been used by the city of Buffalo, N. Y., to provide tax abatements for energy retrofits for multifamily buildings. (This program is described in the next section on the role of city govern merits.)

<sup>25</sup> *New Jersey Mortgage Finance Agency Pilot program: Financing for Residential Solar Hot Water Systems*, p. 1.

<sup>26</sup> *Proceeding of the Multifamily Housing Workshop*, Dec. 4-6, 1980, Deborah L. Blevis, Federation of American Scientists.

<sup>27</sup> *Community Energy strategies: A Preliminary Review*, John H. Alschuler, Jr., May 1980, pp. 72-3.

<sup>28</sup> *Ibid.*, p. 29.

<sup>24</sup> *Interview with Ali Harper*, Pennsylvania Department Of Community Affairs.

Figure 57.—Organizations Which Influence the Energy Retrofit of Housing for Low-Income People

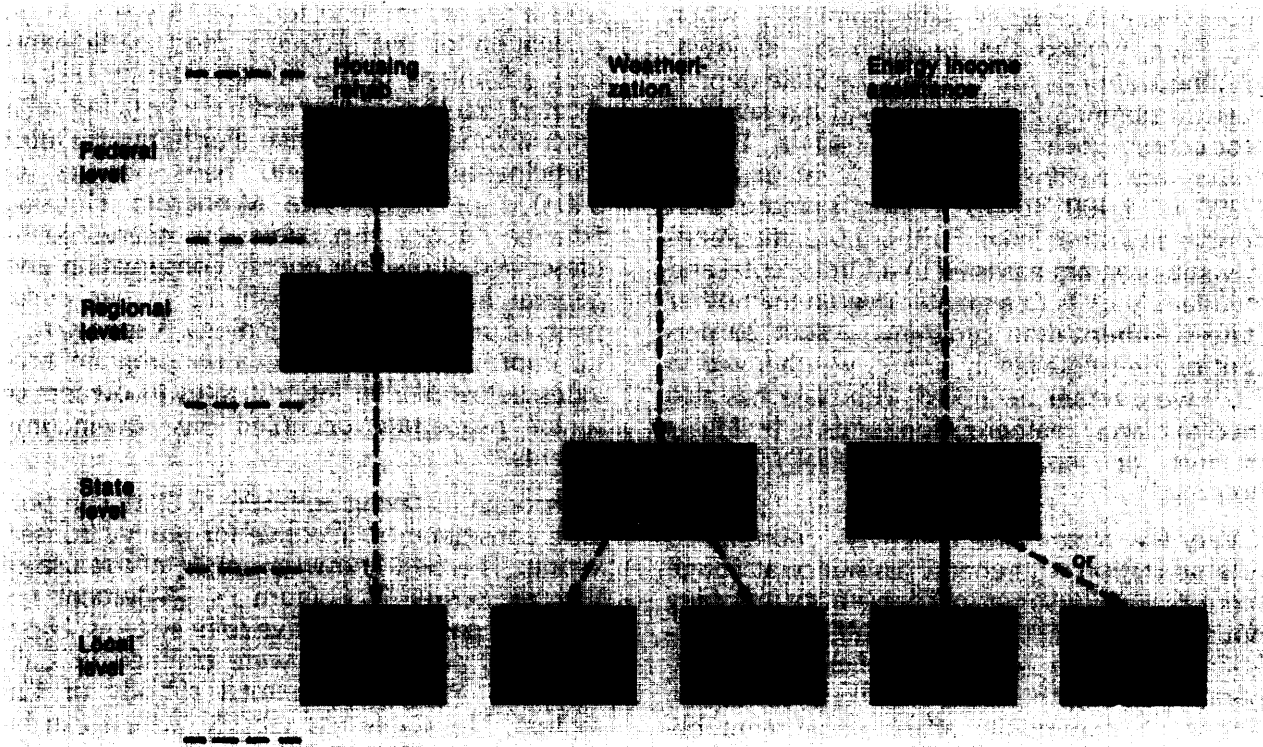

<sup>a</sup>Department of Housing and Urban Development  
<sup>b</sup>Department of Energy.  
<sup>c</sup>Department of Health and Human Services.  
<sup>d</sup>Community Action Program.

SOURCE: Office of Technology Assessment

### Conclusion

States where officials and legislatures are motivated to develop programs to combat energy problems have some powerful tools to use in promoting energy efficiency retrofits. To date, most States have focused these tools on improving the efficiency of owner-occupied residential

buildings of less than four units and have ignored larger multifamily and commercial buildings. The same tools, however, can be used to reach these other types of buildings as is clear from the Massachusetts utility audit program, California utility audit and retrofit program, and the Florida State building code.

### ROLE OF CITY GOVERNMENTS

Some cities have made names for themselves as "pathfinders" in the development of effective programs to stimulate the retrofit of buildings within their boundaries. Energy programs developed by six of these are described in chapter

10. But most city governments have not placed much emphasis on energy. To be sure more than 90 percent (according to a recent survey by the International City Managers Association (ICMA)), have taken steps to control energy

costs in their own municipally owned buildings.<sup>29</sup> But that is in their capacity as *building owners*, and is discussed at the end of this chapter. Only about half the cities surveyed had named energy coordinators and only 5 percent had full-time coordinators.

Cities with active energy programs have many reasons for developing them. Some are located in States such as Minnesota and California where State governments have utility policies, financial assistance, and enthusiastic energy staffs aimed at stimulating energy retrofit in buildings. Some such as Portland, Oreg., and St. Paul, Minn., have had mayors who have made energy one of their prime concerns because they perceive the link between energy problems and housing or economic development. Some cities, such as Baltimore, Md., Boston, Mass., and Buffalo, N. Y., have a tradition of neighborhood organization that lends itself to active energy programs. However, for every city with a reason to develop an active energy program, there are dozens with similar reasons who have not done so. To understand why this might be the case, this section describes the context for energy programs with in city governments, as well as the resources which cities might bring to bear in promoting the energy retrofit of buildings. For much of the discussion, the study draws on case studies of energy concern and activities in five "typical" American cities: Buffalo, N.Y.; Des Moines, Iowa; Jersey City, N. J.; San Antonio, Tex.; and Tampa, Fla. The next chapter on case studies presents brief accounts of each city. Longer accounts will be published in a set of working papers as volume 2 to this report.

**Citizen Concern.** City officials in the five case study cities reported that citizen concern about energy did not, in general, reach city hall. The reasons given were different from city to city. In Buffalo, city officials believed that citizens blamed the utilities for price increases and not city hall. In fact the mayor of Buffalo had spoken against utility price increases in recent rate cases. According to officials in Buffalo, citizens

<sup>29</sup>International City Management Association, *Urban Data Service Report*, vol. 12, No. 8, "An Assessment of Local Government Energy Management Activities."

see energy price increases as part of general inflation. In Des Moines officials believed that citizens regarded energy retrofit as their own responsibility and did not respond to government energy programs. In Tampa, citizens threatened with cutoff of kerosene supplies appealed to the county fuel allocation program but no direct citizen concern reached city hall. In San Antonio, citizen concern was expressed periodically at electricity and gas rate increases by the San Antonio City Public Service Board, a municipal utility.<sup>30</sup>

Even in a 1979 survey of 12 cities and counties with active energy programs DOE concluded that:

In general, energy is not perceived by citizens or local officials as an urgent community problem, especially in comparison to specific other issues . . . the low level of citizen activity in the localities studied appears to reflect a widespread disbelief in the existence of an energy crisis, the lack of an identifiable energy issue in most jurisdictions, confusion about what are appropriate and effective measures, and the absence of clearly defined constituent groups with an interest in broad energy conservation.<sup>31</sup>

The one form in which city governments feel citizen concern directly is when there are complaints that landlords are not supplying enough heat. Officials in Jersey City, a case study city with predominantly multifamily buildings, reported that heat complaints increased from 2,400 to 3,400 from 1979-80 to 1980-81.<sup>32</sup> Reflecting the far greater scale of New York City, heat complaints there increased from 225,000 to 320,000 in the 2 years from 1978-79 to 1980-81.<sup>33</sup> Virtually all cities include minimum heat requirements for multifamily buildings in their

<sup>30</sup>See the chapter on case studies for more details. Complete case studies and documentation of interviews and written sources used in preparing the case studies will be published in vol. 2: *Working Papers* of this report.

<sup>31</sup>Local Government Energy Activities: Detailed Analysis of Twelve Cities and Counties, USDOE, 1979. The 12 cities and counties were: Boston, Mass.; Pittsburgh and Allegheny County, Pa.; Dade County, Fla.; Los Angeles city and county; Oakland, Calif.; Alameda County, Calif.; Seattle and King County, Wash.; and Minneapolis and Hennepin County, Minn.

<sup>32</sup>See Jersey City case study.

<sup>33</sup>Information from Joseph M. White, director of operations, Division of Code Enforcement, New York City Department of Housing Preservation and Development.

building codes. Rapid increases in fuel prices, especially of fuel oil, have induced more landlords to save money by cutting back on heat.

It is against this backdrop of citizen apathy that mayors may decide that a campaign is necessary to alert people to energy problems and what they can do about them. The Fitchburg campaign (described in ch. 5) to make low cost/no cost retrofit materials and information available to its citizens had a side benefit of generating interest in energy programs. The St. Paul energy mobilization (described **in the case studies** in the next chapter) was also very successful in stimulating citizen interest in the potential for energy retrofit.

**Housing.** Virtually all cities have some kind of housing rehabilitation program. Energy efficiency is usually one of the goals of the housing program, although usually ranked in priority after structural problems and threats to hygiene and fire safety. The abandonment of housing in the central cities of metropolitan areas with stable or declining populations is regarded as a more general problem of housing supply and economics but in some cases, such as Jersey City and Buffalo, energy is perceived as the straw that broke the camel's back.

In Buffalo, officials cited concern about a shrinking property tax base as a reason to have programs for maintaining a healthy housing stock. In San Antonio, on the other hand, the deputy city manager reported that in Texas there is a strong tradition that private property as a "tax base" is of no concern to the city government, San Antonio not only has a growing population and tax base but is somewhat free of dependence on the property tax by its ownership of a municipal utility that provides 40 percent of the city's annual revenues. On the average, cities derive 40 percent of their revenues from property tax but in some cities the share is much larger. In Boston, for example, income from property tax is 70 percent of the total.<sup>34</sup>

<sup>34</sup>Henry Lee, "The Role of Local Governments in Promoting Energy Efficiency," Energy and Environmental Policy Center, JFK School of Government, Harvard University, December 1980, p. 12.

**Economic Development.** The perceived link of energy to economic development is much weaker than the link to housing. In theory the creation of local retrofit jobs and reduction through retrofit of money spent on fuel oil and natural gas helps stimulate the local economy. A few cities have obtained UDAGs for energy conservation programs. These grants are intended to match private investment for purposes of creating local jobs. In practice, OTA was not able to identify any examples of explicit justification of city energy retrofit programs for purposes of economic development.

**Energy Among Other City Priorities.** In all the case study cities, energy was outranked as a concern by other pressing problems that did "reach city hall." In Buffalo and Jersey City the overriding concern was general economic development through downtown development in Buffalo's case and through the attraction of new industries in Jersey City's case. In Tampa and San Antonio the inadequacy of the cities' storm sewers was a serious problem. Buffalo city officials were concerned about the safety of local bridges and streets. A recent survey of Michigan communities reported that energy ranked third—after public health and safety and inflation—among problems considered by Michigan municipal officials in the community planning process.<sup>35</sup>

**Building Retrofit Among Other Energy Priorities.** The retrofit of housing and commercial buildings within city borders is only one of several energy programs that a city might undertake. Apart from retrofit of its own municipal buildings (see discussion below) a city government might: launch a car and van pooling matching program (as did San Antonio), a street light efficiency program (Tampa), or a program to develop guidelines **for energy-efficient zoning and site development** (San Antonio). Other programs and concerns such as these compete for the limited time of the city energy coordinator.

<sup>35</sup>Michigan Officials Answer Energy Questions, "a report on a survey by Proaction Institute, *Energy Conservation Digest*, vol. V, No. 1, Jan. 4, 1982.



## City Resources for Building Retrofit

If city officials decide to launch **one or more programs to promote energy retrofit** in their city's building stock they have several potential tools at their disposal: Federal housing rehabilitation funds, other Federal funds, local financing assistance through a bond issue or the tax system, building codes, and planning and organizational activity by city staff.

**Housing Rehabilitation Funds.** The several Federal housing rehabilitation programs described above are usually administered through a city housing or community affairs department. Cities differ markedly in their housing programs. At **one extreme, the city of Tampa funds a small number of extremely thorough rehabilitations (averaging \$17,000 each), which are financed by the city for 20 to 30 years. Tampa's 1980 housing assistance plan set a 3-year goal of only 141 dwelling units.**<sup>36</sup> At the other extreme, the cities of **Portland, Oreg., and Pittsburgh, Pa.,** have both developed high-volume rehabilitation programs each funding more than a thousand dwelling units each year. Both cities have developed close cooperation with local banks in processing applications for funds and making loans.

CDBGs make up the bulk of the typical city's housing rehabilitation budget. In 1980, 220,000 housing units were rehabilitated with CDBG funds at a total of \$1 billion, about 60 percent of which was Federal money and the rest was leveraged private loans.<sup>37</sup> For cities, setting CDBG priorities is a microcosm of the issues that confront the city at large. There are many claims on the CDBG dollar within neighborhoods and energy may not be high on the list, when it is competing with sidewalk repairs, flood control, and more general rehabilitation concerns. In fact, of 6,600 communities that receive CDBG funds, only a handful thus far have chosen to direct these moneys toward energy conservation in a serious way. HUD has documented 10

<sup>36</sup>Interview with Ron Rotello, director of housing inspections, city of Tampa; "Sixth Entitlement Application" [for CDBG funds] Department of Revenue and Finance, Bureau of Community Development.

<sup>37</sup>Judy Kossy, HUD, Office of Community Planning and Development programs.

of these and about five more are known.<sup>38</sup> **Most city rehabilitation programs acknowledge energy as an objective** for rehabilitation but it is low on the list after correcting code violations and making exterior repairs that will help improve the ambience of a neighborhood. Boston and Pittsburgh are two notable exceptions (see case studies in ch. 10) which have used CDBG directly to promote energy conservation.

There are several advantages to close links between energy retrofit and more general rehabilitation programs. One is that older buildings may need substantial repairs in windows or roofs that are not strictly energy conservation but which are needed to make storm windows or roof insulation effective. A second advantage is that an owner generally considers the economic prospects of the building as a whole when considering an investment in **energy retrofit**. The owner's judgment that the value of the energy retrofit investment can be recovered is likely to be enhanced by the perception that the property is being generally upgraded through rehabilitation. CDBG rehab efforts are often concentrated in neighborhoods where many owners are persuaded to rehabilitate their property at the same time. Private rehabilitation in such neighborhoods may be linked to public investments such as tree planting, sidewalk repair, or storm sewers. These too can help convince an owner that the value of an energy investment can be recovered.

**Coordination of Energy Assistance, Rehabilitation, and Weatherization Programs.** Occasionally cities are able to coordinate three Federal programs that affect the energy costs of the urban poor. Generally each program administered by a completely different set of State, county, city, and nonprofit organizations. Figure 57 above displays the tangle of agencies involved. Federal housing rehabilitation funds are the only funds that come directly to city governments, generally to housing and community affairs departments through over 90 HUD area offices that manage the details of each city grant. Federal energy assistance funds

<sup>38</sup>HUD, Office of Community Planning and Development, *Block Grant Energy Conservation Programs*, April 1980, HUD 568 (CPD).

are generally allocated by State welfare or human resource agencies to county welfare offices. Federal weatherization funds come to **State departments of economic development or community affairs and are then allocated to local nonprofit community action agencies.** In the case study cities, Buffalo and Tampa, there was very poor coordination among the agencies administering the three programs.

Des Moines, Iowa, however, illustrates one approach that cities can use. The city government has one department for its antipoverty and community affairs programs. That department administers weatherization, low-income energy assistance, and housing rehabilitation. This is possible in part because the State of Iowa chooses to let some cities, rather than only counties, administer welfare programs. Weatherization and direct cash assistance are well coordinated. Households are routinely referred from one to the other in Des Moines,

**Other Federal Funds.** Cities may also use Federal funds other than housing rehabilitation or weatherization funds for retrofit. The most important of these are probably the UDAGs described above in the section on Federal programs.

The financial base for Portland's comprehensive program is a \$3 million UDAG, which helped leverage \$12 million in private moneys. UDAG now includes energy conservation guidelines and can be used to help finance district heating, cogeneration, and waste-to-energy projects. Trenton, N. J., is using UDAG funds for its cogeneration project and St. Paul expects to finance its district heating plant partly through a UDAG (see ch. 6 on district heating). An advantage of UDAG for urban properties is that it can be used for many sorts of buildings—single-family homes, apartments, offices and commercial projects. Finally, federally funding for public housing (discussed at greater length in ch. 7) is an important resource for a large part of the urban multifamily stock. While there may be cutbacks in all of these Federal programs, they will still make an important contribution to many local budgets.

**City Financing of Building Retrofit.** Cities have two primary options for providing direct financial assistance to building retrofit: municipal bonds and property tax credits and abatements. The only two cities OTA identified that had provided retrofit financing through a bond issue were Minneapolis and Baltimore (see descriptions in the next chapter on case studies). Voters everywhere scrutinize bond issues carefully and are likely to turn down any for which there is not a strong constituency. Furthermore, bond ratings in many older cities have deteriorated over the past decade and some cities, such as Buffalo, are faced with State-imposed ceilings on indebtedness. Given these fund-raising difficulties the first claim for any bond financing is more likely to be energy retrofit of municipal buildings to save energy expense in the annual budget, but even this is difficult (see discussion at end of chapter).

Property tax credits and tax abatements could also prove a powerful incentive to retrofit. OTA found few examples of the use of property tax incentives to stimulate energy efficiency retrofit. At least two cities—New York City and Buffalo, N.Y.—have taken advantage of New York State's enabling legislation to encourage rehab through property tax abatement. New York City's J-51 tax exemption and tax abatement program, started in 1955, was designed specifically to upgrade the city's multifamily stock, but it has become an important energy conservation tool as well. J-51 allows up to  $8\frac{1}{3}$  percent of the cost of improvements to be deducted from property taxes each year up to 20 years until the improvements are 100 percent paid for. Any building with three or more units is eligible. J-51 allows all of the basic energy conservation improvements—boiler and burner conversion, solar units, storm windows and doors, and insulation. In at least one case in Manhattan, it has been used to install solar units on a printing factory that has been converted to multifamily housing. In fiscal year 1980, 75,000 units in 14,100 buildings were rehabbed using the J-51 incentive. The total amount of tax incentives offered that year under the program was \$116 million. The program has been an ex-

tremely popular one, so popular in fact, that the city now finds that the tax incentives are being used for co-op and condominium conversions that serve a higher income market, and there may be limitations on the use of J-51 particularly in Manhattan. While rehab officials in New York do not have precise figures on how the money is being used, they do have a strong sense that much of J-51 financing is going toward energy conservation. If that is the case, this program has been highly successful in reaching the difficult multifamily market.

Buffalo, N. Y., has developed a similar program to encourage energy retrofit in multifamily housing. The city offers a tax abatement for 80 percent of the cost of energy conservation improvements over a period of 10 years. Between November 1980 and December 1981 eight multifamily owners representing more than 200 dwelling units had received such tax relief.<sup>39</sup>

**Regulation: Building Codes and Rent Control.** Local governments have the responsibility for carrying out building code inspections even when there is a mandatory statewide code. In only a few places have actual energy retrofit standards been adopted by cities that go beyond State requirements. For the most part these are triggered by the sale or lease of a property and apply primarily to residential properties. Davis, Calif., requires R-19 attic insulation, low-flow shower heads, weatherstripping, and a hot water blanket on hot water heat for all single and multifamily buildings constructed before 1976. Portland, Oreg., Santa Clara County and Livermore, Calif., have similar requirements upon point of transfer, as do a handful of other communities. With the exception of Portland (see case studies), where the retrofit requirement is tied to the city's other energy programs, financing to pay for retrofit is not linked to these ordinances.

For cities that develop their own energy efficiency building codes, the first problem is how to set energy efficiency standards. Cities may follow the example of Minnesota and set simple specific requirements or they may follow the example of Florida and give points for a variety of

energy-conserving measures. To date Portland has avoided setting any standards. The city's time-of-transfer requirement will not take effect until 1984. Enforcement of energy efficiency codes are also a problem. In the 1979 DOE study of 12 communities, it was reported that enforcing the ASH RAE energy efficiency standards for new buildings increased the time required for a building code inspection by about a third.<sup>40</sup>

Cities can also influence building retrofit through rent control ordinances. One city, Cambridge, Mass., specifically allows a pass-through of the cost of energy efficiency improvements up to the amount of the loan payments on the improvement. In other cities, such as San Francisco, owners are allowed to pass on the cost of major improvements, depreciated over 10 years. Energy efficiency investments may qualify as major improvements.<sup>41</sup>

**Planning and Organization of Retrofit Programs.** For some kinds of retrofit programs, the availability of skilled and enthusiastic city staff in an energy office, housing department, or community affairs department may be as important as the availability of financial resources. Such staff can put together effective energy retrofit programs that draw on utility audit services, private financial resources, neighborhood community groups or co-ops for outreach (see next section on nonprofit groups) and private or public subsidy sources. An outstanding example of such imaginative packaging is the Minneapolis program for conducting concentrated audits and retrofits over 500 city blocks, described in the case studies in the next chapter. The energy bank component of the Minneapolis program requires cooperation between the city that is providing the funding through a revenue bond and the local gas utility, Minnegasco, which originates all loans and services them through its monthly billing operations. City-hired auditors visit the homes of residents organized block-by-block through neighborhood energy workshops. The entire program has been put together by the city energy office with close cooperation from the Minnesota Housing Agency.

<sup>39</sup>Interview with Tom Murphy, office of the mayor, Buffalo, N. Y.

<sup>40</sup>DOE Local Government Energy Activities, op. cit.

<sup>41</sup>Bleviss, op. cit. p. 79.

The most effective planning by cities pays close attention to the energy problems faced by specific constituencies such as small business building owners, owners of small multifamily buildings or owners of large multifamily properties. Ann Arbor, Mich., began its planning process by identifying the key groups in the planning process. City officials thus found it easy to move directly from plans to specific programs.

### **Conclusion**

The experience of the “pathfinders” has demonstrated several practical ways in which cities can make use of their normal authority and resources to stimulate the retrofit of buildings within their boundaries. That many, or even most, cities may be reluctant to develop large-scale programs, despite the example of the pathfinders, is not surprising, for several reasons explored in this section.

For one thing, conservation in buildings, with the exception of housing, is not traditionally the purview of local government. It is the responsibility of the private sector and while city hall can set an example, it cannot do much more. Secondly, there is always the nagging question of priorities. Energy is important in cities and most mayors know it, but whether it is more important than jobs, crime, and abandonment is not clear. Third, many mayors feel that the best way to get at energy problems is to deal with other over-arching problems. They perceive the energy problem largely in economic terms. If a locality’s economy can be bolstered and more money put in citizens’ wallets, rising energy costs would not hurt quite so much. There is a debate in many communities about whether energy costs should be attacked head-on or indirectly through economic and community development.

## **NONPROFIT ORGANIZATIONS**

The nonprofit community is sometimes called the “third sector” by observers and the appellation is particularly appropriate in the case of energy conservation. Virtually every city has at least one community group that has taken up the cause of energy. These activities have taken many forms—promoting conservation, experimenting with alternate sources, and protesting rate increases, among others.

There has been very little systematic effort to compile either descriptive or analytic data on these nonprofit groups. From OTA’s case study cities (see ch. 10) and other descriptive sources, it is clear that the mission and activities of these groups vary widely and so does their influence. In some cities they are weak and disorganized while in others, the third sector has set the pace for the other two—government and profitmaking enterprise—when it comes to energy conservation action.

Buffalo, one of the case study cities, is a good example of the variety of nonprofit groups and how they interact with one another and other institutions in their energy work. The New York

Public Interest Research Group (NYPIRG) has administered a neighborhood-based weatherization program that is a model for both local utilities and city housing officials. Another community group, the Buffalo Energy Project (BEP), is active in outreach programs, education and technical assistance, and promotion of alternative energy sources. BEP is working with the city to set up a windmill to provide power at Buffalo’s waterfront park. The group has already been successful in aiding a private developer in designing a solar heated luxury housing project along the waterfront. A third group, Peoples Power, has pressed for lower utility rates and the establishment of a municipally owned power company. Buffalo does not seem to have strong neighborhood energy groups but these do exist in many other communities. A fourth example of nonprofit activity comes from the case study city of Tampa, Fla., where the chamber of commerce set up its own program (called the HEAT program) to provide energy audits to small businesses. Chamber of commerce members made “sales calls” on about 180 small businesses and about one-third of these signed up for a visit from an energy auditor.

These programs illustrate what is probably the most important function of such nonprofit organizations. They provide a link of trust between building owners considering energy retrofit of their buildings and government programs, utilities or private for-profit companies who are trying to persuade them to retrofit. St. Paul worked with many neighborhood nonprofit organizations to develop specific programs in the months following the St. Paul mobilization, described in the case studies of chapter 10.

Nonprofit groups have other advantages. They can draw on diverse sources of funds and are not constrained by narrow legislative missions in the way that government is. So, in theory, these groups can overcome some of the turf problems that, for example, would separate weatherization from rehabilitation activities or job counseling within city government. Very few nonprofit community groups are well financed, but they can draw on a vast supply of volunteer manpower and in-kind contributions that typically is unavailable for government and business. This is especially valuable in cities, such as Buffalo, where energy is an important issue but where public funds are limited.

From several sources, such as the U.S. Consumer Affairs Office, OTA compiled descriptions of 15 nonprofit community groups involved in building retrofit around the country. (See box O for a sample of these.) Of the functions performed by the 15, by far, the most common is outreach. This can include blanketing a neighborhood with brochures, conducting training workshops and seminars, and even setting up demonstration projects. The next most frequent activity was the purchase and installation of equipment. Only one group was involved in outright financing of energy improvements and it worked closely with the Tennessee Valley Authority which runs one of the largest energy conservation financing programs in the country. This distribution of activities is not particularly surprising. Outreach is a low budget activity that can easily be accomplished by volunteers. Financing requires access to funds that is generally quite limited for such nonprofit groups,

Funding for these groups comes from a variety of places. The most common public sources are CSA, Action, and HUD, especially through community development block grants. These are all funding sources threatened by the 1982-83 budget cuts. Foundations have also been supportive in a few cases. While many nonprofit groups have applied for grants for demonstrations from sources such as the National Center for Appropriate Technology, HUD, and DOE, there is very little such money available. But even in the absence of money, these groups have continued to work away, albeit on shoestring budgets. By and large, the main resources and energy for these groups has come from committed volunteers dedicated to the energy cause.

### Energy Cooperatives

One specialized form of nonprofit enterprise is the cooperative which in theory could be useful in stimulating energy retrofit. Traditionally, cooperatives have offered a wide range of consumer services, including housing, food, insurance, and furniture. In the 1930's, Rural Electric Co-ops (RECs) provided much of the electricity needed in rural parts of the country.<sup>42</sup> There are several ways in which the co-op idea could take root in cities. These include establishing co-ops for bulk fuel purchasing, weatherization, and solar equipment.

Despite their potential, OTA was able to identify only a handful of urban energy co-ops across the country although fuel wood co-ops have flourished in rural areas. To many consumers, the advantages of these enterprises are more theoretical than real. Energy co-ops require heavy capitalization and strong management, just like any other successful business enterprise. They also require active participation of members, a commitment that has thus far not been forthcoming perhaps because the benefits are still perceived as uncertain.

**Weatherization.** A weatherization co-op could offer several benefits to its members: dis-

<sup>42</sup>Jerry Hagstrom "Whose Co-op Bank?" *Working Papers*, July/August 1980, p. 26.

counts on materials and equipment; in-house servicing; amortized repayment schedule to members; and nominal upfront costs to members. This type of co-op would basically act as a broker between members and producers. Surprisingly, only two such co-ops were identified by OTA.

The Solar and Insulation Co-Op, Inc. (**SICI**), **Lansing, Mich., was established in April 1980** as a worker-owned producer co-op. SICI sells and installs insulation (20 homes to date), window quilts and other conservation materials, and solar hot water systems. The co-op is presently contracting with the State bureau of community services to weatherize 50 low-income residents' homes. Another co-op, the Boston Materials Buying Co-op, sells blown-in insulation and related materials and interior/exterior storm windows to members at cost of purchase and delivery. In addition, it conducts technical education programs and has published a basic home repair report. An important aspect of both co-ops is the sharing of information, skills, and buying power.<sup>43</sup>

The success of these co-ops is dependent on their access to capital in order to obtain maximum materials discounts. To ensure member acceptance, the co-op may have to offer fully amortized financing over a long period of time for materials that are fairly expensive. The weatherization co-op may have more of an impact on cities and low-income people than other co-op types. However, because of the need for large capital outlays and time commitments, very few of these co-ops exist.

**Solar Co-ops.** Solar co-ops can undertake the manufacture, installation, and sale of solar equipment, and provide solar energy information. Several solar co-ops exist in the country. The Santa Fe Community Solar Co-op Association provides Santa Fe students with an individualized multimedia curriculum in passive solar theory and application. It hopes to do a five-county solar retrofit demonstration project and would like to move into energy auditing and retrofit. Solar co-ops also require large amounts of

capital to obtain materials at a discount and long-term financing to keep and attract new members. To be successful, a solar co-op must offer net savings and install high quality equipment at a discount.<sup>44</sup>

**Bulk Fuel Purchasing.** Fuel purchasing co-ops do not in themselves stimulate energy retrofit but they provide an energy-related service to consumers and an organizational structure that could in theory be expanded to energy retrofit. OTA identified only two operating fuel purchasing co-ops.

The Association of Neighborhood Housing Developers (ANHD) in New York City found that per unit fuel oil costs negotiated on a volume basis would be from 11.4 percent (for No. 2 fuel oil) to 25.3 percent (for No. 6 fuel oil) less than current average fuel costs for buildings which were not cooperative members. In 1980, the ANHD organized 105 predominantly low-income, tenant-owned apartment buildings for inclusion in its bulk fuel oil buying program. Also, the Housing Energy Alliance for Tenants' (HEAT) has established a bulk fuel cooperative with 39 buildings in its network. HEAT is working with several established housing organizations in New York City, such as the People's Development Corp., Harlem Restoration, and numerous tenant-managed buildings.<sup>45</sup>

However, there are problems in putting together a fuel purchasing co-op. Because of the volatility in oil prices, distributors are reluctant to set discount price. Also, the high return on fuel sales has removed the incentive for dealers to build stable clientele. These problems were quite evident in Cranston, R. I., where plans for a fuel oil co-op failed to materialize because of the unwillingness of distributors to work with co-op people. Another constraint to establishing this type of co-op is large capital requirements, which are seasonal and short term. Member capitalization could provide some dol-

<sup>44</sup>"List of Known Energy Co-ops," Michael Freedburg, Conference/Alternative State and Local Policies, No date.

<sup>45</sup>Conference/Alternative State and Local Policies, "Energy and the Co-op Bank: A Role for the National Consumer Cooperative Bank in Meeting Community-%, J1 (> Energy Needs," December 1979, p.9; telephone conversations with Anne Hartwell ANHD, Nov. 10, 1981.

<sup>43</sup>"Futures" for Energy Cooperatives, DOE, Office of Commercialization, Conservation and Solar Energy, December 1980, p.69.

lars but not nearly enough in low and moderate income areas. To attract and keep members, the bulk fuel purchasing co-op would have to offer clearcut savings and attractive payment plans.<sup>46</sup>

**The National Consumer Cooperative Bank (NCCB).** The NCCB was established by an act of Congress to provide financial and technical assistance to existing and emerging co-ops and was signed into law on August 20, 1978. One of the Bank's goals is to put 35 percent of its money into low-income co-ops or those that serve primarily low-income groups. Also, the NCCB intends to spend no more than 35 percent of its assets for housing co-ops and up to 10 percent for producer co-ops, leaving 55 percent for consumer and self-help co-ops. The Bank has been affected by recent funding cuts and it remains to be seen if it will give a boost to the formation of new energy co-ops.

<sup>46</sup>Conference/Alternative State and Local Policies Seminar, "Energy and the Co-op Bank," Dec. 20, 1979.

## Conclusions

Community and business nonprofit organizations and energy co-ops can offer a valuable flexibility to energy retrofit. More important, they can provide a missing climate of trust between building owners and tenants contemplating retrofit on the one hand and government or for-profit retrofit programs on the other. However, at this stage their overall influence on retrofit appears to be limited first of all because of lack of access to capital and second because of the management challenge of developing a successful retrofit program. Community and business groups are probably best suited to outreach, the function they perform most frequently. Energy retrofit co-ops may become more common as the techniques and benefits of retrofit become more widely known. A stable source of capital and technical assistance, such as the National Consumer Cooperative Bank could also stimulate the formation of more energy retrofit cooperatives in the future.

## Box O.-A Sampling of Nonprofit Groups

**North Omaha Community Development, Inc. (NOCD), Omaha, Nebr.—NOCD is a nonprofit community-based coalition of 14 organized neighborhood associations. Its goals and objectives include the development of a comprehensive community plan to guide area growth; development of an energy conservation program to rehabilitate and weatherize area homes; and promotion of food, health, and energy co-ops. Much of the funding for NOCD activities is obtained through city CBDG funds. NOCD is earmarked to receive \$1.7 million of the city's \$5 million CBDG funds. In addition, NOCD has been awarded an ACTION Mini-Grant to implement an energy conservation program. Presently, 25 volunteers, trained in home energy auditing, are visiting homes and providing homeowners with recommendations to improve energy efficiency. While inspecting homes, the auditors will also provide the homeowner with general information regarding energy conservation and renewable energy sources.**

**11th Street Housing Development Fund Corp., New York, N.Y.—Originally organized as a farmer's co-op, the 11th Street Corp. is now a nonprofit neighborhood association in the process of building a 525 ft<sup>2</sup> greenhouse on top of a renovated building. In 1973 the farmers co-op group decided to reoccupy an abandoned burned-out building shell at 519 E. 11th Street with the help of a city program called "sweat equity." The "sweat equity" program allowed low-income people to use their labor as a downpayment on city loans to buy and renovate deteriorated buildings. After lengthy negotiations, the group won a \$177,000 sweat equity loan from the city in 1974. All of the renovation was to be done by future occupants with each person contributing a minimum of 8 hours/week. In March 1976 the corporation was formed. Since then the corporation has secured a \$43,000 grant from CSA for an energy conservation and solar hot water project. With the aid of another nonprofit group, set up to provide technical assistance (see below), as well as tenant**

owners and volunteers, the building was insulated, storm windows installed, and solar hot water systems built. Another CSA grant was given to the corporation for the construction of a small wind generator, which provides about one-third of the lighting in the buildings halls and other common areas. Because of the insulation and the wind generator, energy costs have been cut substantially, and w&n excess electricity is generated by the windmill it flows into the Consolidated Edison grid. Con Ed must pay for the excess electricity.<sup>2</sup>

**The Energy Task Force, New York, N.Y.**—ETF is a group of architects, engineers, builders, and educators that advise, train and educate low-income community groups about energy matters in New York City. The group puts strong emphasis on community outreach through workshops and demonstration projects. ETF has provided technical assistance to the 11th Street Corp. in constructing and installing its windmills. Other ETF projects include R&O for a prototypical rooftop greenhouse for a tenement building; weatherization and conservation workshops, and the retrofitting of a five-story tenement building in New York City's Lower East Side. ETF also completed an urban solar and energy conservation manual. Much of the money to carry out the technical assistance comes from CSA.<sup>3</sup>

**San Bernadino West Side Community Development Corp., San Bernadino, Calif.**—The corporation is a nonprofit group dedicated to teaching area residents valuable job skills while rehabilitating the area. West Side residents were trained to build a centralized sun-powered energy system, which would heat 10 homes, and a solar greenhouse, which would provide produce for local residents. The centralized system consists of 72 solar collectors, arranged in elevated rows behind the homes and a 4-ton, 5,000-gallon tank with storage capacity to heat all 10 homes for 4 sunless days. From 1973 to 1979, the corporation has trained over 650 residents, majority of which have gotten jobs with nearby California corporations. In the 1979, the corporation opened its Energy Technology Center, a certified solar vocational school. Funding for these projects has come from HUD, CSA, CETA, and the California State Energy Commission.<sup>4</sup>

#### **South Memphis Development & ~ &**

The corporation and the Tennessee Valley Authority are responsible for creating Solar Mere-

phis, a project which helps area homeowners cut heating costs by offering an affordable solar water heating system, and provides training and employment to local residents. The systems are installed by local contractors and parts are purchased from the businessmen. The corporation offers 20-year loans at low-interest rates of 3.3 percent and monthly payments. Since May 1978, 2,400 systems have been installed in over 400 homes in Memphis and Shelby County. The success of the project has led to the planning of an expansion of the project across the Western Tennessee Valley.<sup>5</sup>

**The Urban Ark, Evanston, Ill.**—The Urban Ark is a nonprofit conservation project sponsored by the Evanston Environmental Association (EEA) and the city's office of housing. Local officials allocated \$50,000 from the city's fiscal year 1980 CDBG entitlement—funds for a neighborhood information and demonstration program on the viability of solar energy retrofitting to benefit low- and moderate-income families. Families in neighborhoods meeting CDBG income requirements and living in weatherized homes were eligible for the Solar Demonstration Program, which included audits and installation. A minority housing contractor was selected to work on the first three homes. The EEA estimates that the homeowner will save approximately 60 percent off the cost of his/her fuel bill and expects the payback to a period of 9 years.

The Urban Ark is currently running workshops to teach a variety of conservation techniques to neighborhood residents and securing an independent status for Urban Ark not-for-profit organization underway. Ark intends to apply for additional CDBG funding to sponsor an energy co-op among participants, and to construct use

<sup>1</sup>North Omaha Community Development, Inc., Newsletter, "With One Voice," vol. 1, June 1980.

<sup>2</sup>Energy Task Force, *No Heat, No Rent: An Urban Solar and Energy Conservation Manual*, 1977; U.S. Department of Housing and Urban Development, "Neighborhood Energy Strategies," GPO 311-300/36, Washington, D.C., 1980, p.5.

<sup>3</sup>Energy Task Force Fact Sheet, no date.

<sup>4</sup>U.S. Consumer Affairs Office, *People Power*, Washington, D.C., no date, p. 282.

<sup>5</sup>U.S. Consumer Affairs Office, *People Power*, Washington, D.C., no date, pp. 210-211.

<sup>6</sup>U.S. Department of Housing and Urban Development, Office of Community Planning and Development, *Block Grant Energy Conservation*, April 1980, pp.20-30 (HUD-568-CPD).



## WHEN THE CITY GOVERNMENT IS THE BUILDING OWNER

City governments are not only potential developers of programs to persuade other to retrofit; they are owners of buildings in their own right. There are, according to one estimate, over 100,000 municipally owned buildings including those owned by cities suburbs, and small towns. In addition there are estimated to be almost 300,000 school buildings, most of which are owned by local school districts.<sup>47</sup>

According to a recent survey by the international City Managers Association more than 90 percent of all cities have taken steps to curtail energy use in municipal buildings. Almost 90 percent have conducted audits in one or more of their buildings. For about 60 percent of the cities surveyed, energy is the second biggest item in their budget after personnel.<sup>48</sup>

At the same time there is only sketchy data on what energy efficiency improvements are actually being made in such buildings. According to data in a 1981 DOE survey of commercial (nonresidential) buildings, buildings owned and occupied by the government were more likely than privately owned buildings to have regular maintenance and somewhat less likely to have had recent improvements in energy efficiency such as weatherstripping, caulking, insulation, treated glass, or outside shading. There is no data about investments in improved heating and cooling systems for either publicly or privately owned buildings.<sup>49</sup>

The above survey data is compatible with OTA's observations on the retrofit of municipal and school buildings in the five case study cities. officials in all five cities were concerned about escalating energy costs and all had taken steps to curtail them with greater and lesser success.

<sup>47</sup>The actual estimate is 116,000 municipal buildings made in the course of an evaluation of the DOE Schools and Hospitals Program. "Status and Performance of the Institutional Conservation Program: An Interim Report," Synectics Group, Inc., for the Department of Energy, draft report May 1981, p. 3.

<sup>48</sup>International City Management Association, op. cit.

<sup>49</sup>Nonresidential Buildings Energy Consumption Survey: Fuel characteristics and Conservation Practices, Department of Energy, Energy Information Agency, June 1981, pp. 229-230.

In Tampa, electricity use by buildings (most of Tampa's building energy use) represented about 5 percent of a total city budget of about \$80 million. Des Moines' building energy cost was a much lower fraction of the total budget, a little more than 1 percent. The other case study cities did not break out building energy use as a budget line.

For all the cities, however, making operating improvements to save energy was easier than making capital investments in energy efficiency. Tampa, San Antonio, and Des Moines all set energy reduction goals for each department head for both building energy use and vehicle use of fuel. These were firm quotas in the case of Tampa; goals in the other cities. Both Jersey City and Des Moines had "energy squads" in their cities reminding employees to turn off lights and turn down thermostats. In neither city did they work as hoped. Said one person close to the effort in Jersey City, "People just didn't understand what we were doing. They would still turn up the thermostats and open the windows." Public Service Electric & Gas officials estimate that Jersey City failed to realize a potential \$100,000 a year in energy savings. On the other hand, the school district serving Tampa (Hillsborough County) has taken an imaginative approach to stimulating good energy management among its schools. A portion of the savings are returned to principals to use as they decide. In 1979-80, \$73,000 out of \$172,000 savings were returned to principals for their use.

officials in all the cities realize that capital investments in energy efficiency would cut down on operating expense for energy. In most cities, however, it has been difficult to obtain capital for any but the shortest payback investments. In Jersey City the city will not spend money on energy improvements unless it is paid for by someone else. Federal public works funds paid for new windows on a firehouse, for example. City officials prepared two proposed bond issues for energy retrofit in Buffalo but voters turned them down. Buffalo's bond rating has deteriorated to a B and the State has imposed

limits on new bond issues. Des Moines has prepared a 5-year capital improvement plan for municipal buildings including energy conservation measures, but does not expect to find the funds unless there are Federal public works funds available. Iowa has placed a 4 percent limit on growth in assessed valuation in 1981-82 and this has exacerbated a problem of declining tax revenues said to be due to an exodus to the suburbs typical of many cities. In previous years, Des Moines has used general revenue sharing funds for capital projects but more recently has had to use these for operating expenses. Des Moines has not even been able to find the funds for five **energy audits of city buildings** set as a goal last year. All three of these cities have linked energy efficiency measures, when possible, to other major repairs on their buildings. All of them, for example, have installed roof insulation when roofs are repaired.

More schools than municipal building have been retrofitted in some of the five cities. Buffalo has completed audits on all its schools and has retrofitted about 40 of them using a Federal public works grant. A little money has also **been made available from a city bond issue** for building repair. The school board has a professional property management staff including an energy

analyst. The Hillsborough County School Board, covering Tampa's schools, also has an energy advisor and is proceeding methodically. Once testing is complete on a computerized energy management control system **in one school, it will be extended to 16** other schools. The school district has been successful in using bond issues to cover the capital costs of these investments.

As owners of buildings, city governments and school districts resemble large corporations and insurance companies in one respect, Like these private owners of buildings (see ch. 4) they have professional property management staffs and even their own energy conservation advisors. They can test retrofits in one building before applying them to other buildings. They can set realistic energy saving goals for managers. However, such public building owners also resemble individual and small partnership owners of buildings in their limited access to capital and their very short payback criteria. Thus the prospects for energy savings through better operations and management in the public buildings are probably better than in many privately owned buildings and the prospects for energy savings through capital investment in energy efficiency are probably worse.

---

**Chapter 10**  
**Case Studies**

# Contents

|  | Page       |
|--|------------|
| <b>Pathfinder Cities: Six Energy Retrofit Programs That Have Worked. . . . .</b>   | <b>269</b> |
| <b>Building a Constituency for Energy in St. Paul. . . . .</b>   | <b>270</b> |
| <b>An “Energy Smorgasbord:” Portland, Oreg. . . . .</b>  | <b>270</b> |
| <b>Minneapolis: Low Cost Loans for High Cost Energy Improvements. . . . .</b>  | <b>272</b> |
| <b>Retrofit and Rehab: A Tale of Three Cities:</b>   |            |
| <b>Pittsburgh, Boston, Baltimore. . . . .</b>  | <b>273</b> |
| <b>Pittsburgh . . . . .</b>  | <b>274</b> |
| <b>Boston . . . . .</b>  | <b>274</b> |
| <b>Baltimore . . . . .</b>   | <b>275</b> |
| <b>Large-Scale Retrofit: Prospects in Five Typical Cities. . . . .</b>   | <b>276</b> |
| <b>Buffalo . . . . .</b>   | <b>277</b> |
| <b>Des Moines. . . . .</b>   | <b>281</b> |
| <b>Tampa . . . . .</b>   | <b>283</b> |
| <b>Jersey City. . . . .</b>  | <b>285</b> |
| <b>San Antonio . . . . .</b>   | <b>288</b> |
| <b>Summing Up. . . . .</b>   | <b>290</b> |
| <b>Chapter IO Appendix: information on the Housing Characteristics, Heating and Cooling Equipment, and Residential Fuel Use of the Case Study Cities . . . . .</b> | <b>292</b> |

## LIST OF TABLES

| <i>Table No,</i>  | Page       |
|---|------------|
| <b>84. Population indicators: Case Study Cities . . . . .</b>                                 | <b>276</b> |
| <b>85. Climate Data: Case Study Cities . . . . .</b>  | <b>276</b> |
| <b>86. Average Residential Gas and Electric Rates: Case Study Cities, . . . . .</b>           | <b>277</b> |
| <b>87. Housing Characteristics: Case Study Cities. . . . .</b>                                | <b>277</b> |
| <b>88. Federally Assisted Housing and Energy Program Activity: Case Study Cities. . . . .</b> | <b>277</b> |
| <b>A-1. Housing Characteristics: Case Study Cities. . . . .</b>                               | <b>292</b> |
| <b>A-2. Residential Heating and Cooling Equipment: Case Study Cities. . . . .</b>             | <b>294</b> |
| <b>A-3. Residential Fuel Use: Case Study Cities . . . . .</b>                                 | <b>295</b> |

## LIST OF BOXES

|                                 | Page       |
|---------------------------------|------------|
| <b>P. Buffalo . . . . .</b>     | <b>278</b> |
| <b>Q. Des Moines. . . . .</b>   | <b>281</b> |
| <b>R. Tampa . . . . .</b>       | <b>283</b> |
| <b>S. Jersey City. . . . .</b>  | <b>286</b> |
| <b>T. San Antonio . . . . .</b> | <b>288</b> |

Just as it is difficult to predict the outcome of a retrofit for a particular building, it is similarly hazardous to posit what factors in a city will come together to create an environment that fosters conservation activity. In some cities, rapid rises in utility rates will focus private attention on the need for retrofit. In others, a concern that high energy prices are escalating the pace of abandonment and housing deterioration will arouse public concern for linking retrofit with rehab. Some cities benefit from their State's aggressive interest in energy conservation. Others have a mayor or city manager who links the community's future to conservation. In some cities, the leadership may come from a single lender, or an active chamber of commerce, or a group of architects and engineers. In other cities, neighborhood and community groups provide the spur. **In some cases, a Federal demonstration grant or the creative use of block grant funds puts energy high on the civic agenda. In some cities, the utility, through a vigorous marketing of audits and financing, helps foster retrofit.**

In a few cities, "pathfinder cities," many of these factors come together to create the energy that fosters retrofit on a large scale. This has happened in Portland, Oreg.; in St. Paul and Minneapolis, Minn.; and to a lesser extent in Boston, Mass.; Pittsburgh, Pa., and Baltimore, Md. This chapter begins with descriptions of effective energy conservation in these six cities to illustrate the combination of local traditions and leadership and effective program design that

can bring about energy retrofit in buildings on a fairly large scale.

In most cities, however, the interest in conservation is the product of incremental actions, of slow starts and stops, that eventually add up, although the total may be difficult to calculate. **But exactly what the factors are that work, where they will work, and what their outcome will be is almost impossible to predict.** There are about as many possible combinations as there are cities. Indeed, one of the only generalizations that can be usefully made about energy and cities is that energy issues are not isolated problems. Interest in energy and initiatives to deal with energy issues, no matter who the prime movers are, is really a function of the overall urban environment—its economy, its politics, the condition of buildings and a variety of other factors. The importance that energy is given at the local level depends largely on what other things are of concern in the community. To illustrate the diversity of influences on the prospects for improvement of building energy efficiency, OTA conducted case studies of five typical cities: Buffalo, N. Y.; Des Moines, Iowa; Jersey City, N. J.; San Antonio, Tex.; and Tampa, Fla.

The rest of this chapter summarizes first, the case studies of six effective building retrofit programs in the "pathfinder" cities and second, the case studies of the prospects for retrofit of urban buildings in five typical cities.

## PATHFINDER CITIES: SIX ENERGY RETROFIT PROGRAMS THAT HAVE WORKED

Not all the "pathfinder cities," which have been leaders in developing energy retrofit programs, are represented in the six descriptions that follow. Some, such as Los Angeles and Seattle, have been described elsewhere.<sup>1</sup> Energy ret-

<sup>1</sup>There are several surveys of community energy programs: John H. Alschuler, Jr., *Community Energy Strategies A Preliminary Re-*

etrofit programs in six cities, however, do represent a variety of approaches that work. Two others, the Fitchburg ACTION Program and the

*view.* A report to the Ford Foundation May 1980; *Proceedings of the Multi-Family Housing Workshop*, Dec. 4-6, 1980. Report prepared by Deborah L. Bleviss, Federation of American Scientists; Council of Northeast Municipalities, CONEM, *Multi-Family Energy Conservation: A Reader*, published July 1981.

Philadelphia Furnace Efficiency Retrofit Program could be added to the list. Both of these are described in chapter 5.

The retrofit programs described include:

- one communitywide mobilization (St. Paul),
- one retrofit program linking utilities and citywide regulation (Portland),
- one retrofit program linking utilities and neighborhood groups (Minneapolis),
- three programs that link housing rehabilitation and retrofit programs (Boston, Pittsburgh, and Baltimore).

### Building a Constituency for Energy in St. Paul

Mayor George Latimer has made energy a cause celebre in St. Paul and in contrast to most other cities put it at the top of the municipal agenda. On January 18, 1980, the mayor announced the "St. Paul Energy Mobilization" designed to get information on low-cost/no-cost weatherization to every home and business in the city. The mayor mailed out 110,000 energy questionnaires to virtually every household and business in the city to survey energy attitudes and activities. On 3 days in mid-February a small army of 3,000 city employees and volunteers was deployed throughout St. Paul. All nonessential city employees were given the 3 days off to participate in the mobilization. Almost 40 percent of the households and businesses in the city were reached under the program.<sup>2</sup>

The mobilization was only part of a broader energy effort started by the city that includes development of a district heating network for St. Paul and construction of a model energy industrial and residential parks

While there is no good data on the extent to which low-cost/no-cost measures were actually taken in St. Paul, the city's efforts are noteworthy for two reasons. First, as a result of the

<sup>2</sup>Susan Shullaw, "A Salute to St. Paul: Now Entering Energy City . . .," *Buildings*, November 1980.

<sup>3</sup>Deborah R. Both, Robert Dubinsky, and Sue Bodily, *A Description of Integrated Retrofit Delivery Systems and Innovative Conservation Services Programs in Selected Localities*, The Rand Corp., March 1981 (N-1 67 J-DOE), p. 32.

mobilization, St. Paul now has one of the best data bases on energy needs and activities of any city in the country. Second, and even more important, the mobilization clearly built up a constituency for energy conservation in the city. As John H. Alschuler, Jr., observes in his evaluation for the Ford Foundation: "Finally, the St. Paul community was indeed 'mobilized.' Almost every businessman, homeowner, and tenant in the city was in some way impacted by the effort. For some, the mobilization provided only information, for others it was a way to participate and help to solve the energy crisis," "Since the mobilization, the city has worked closely with the strong neighborhood groups in the city and has primarily relied on these organizations to implement specific energy programs. The city energy office has sent a Caulkmobile, manned by volunteer weatherization teachers, to each of the city's 17 neighborhoods. The Caulkmobile visits on Saturday mornings and delivers caulking materials and free help to local residents.

### An "Energy Smorgasbord:" Portland, Oreg.

In 1979, the city of Portland passed an ordinance outlining a comprehensive energy policy for the city. It included the following stipulation:

All buildings in the city shall be made as energy efficient as is economically possible as determined by costs of conservation actions and price of energy. **The retrofit of existing buildings for the purpose of energy conservation shall be accomplished through voluntary actions initially, with mandatory requirements imposed 5 years after the adoption of the policy. Retrofit programs and the requirements must be cost effective, comprehensive, and have the most equitable impact possible on all sectors of the community.**<sup>4</sup>

In evaluating the portland energy policy for the Ford Foundation, John H. Alschuler, Jr., observes: "The symbol of the Portland Energy Policy is its mandatory requirement. The guts of the policy is its commitment to provide financial

<sup>4</sup>Alschuler, op. cit., p. 93.

<sup>5</sup>Ordinance No. 148251, "An Ordinance Adopting an Energy Conservation Policy for Portland," Aug. 15, 1979.



Photo credit: St. Paul Office of the Mayor

In St. Paul, Minn., a Caulkmobile visits neighborhoods and distributes materials and information for caulking and other low cost energy efficiency measures

**arrangements which permit compliance with the policy without undue hardship. ”<sup>6</sup>**

Portland’s retrofit requirement is as comprehensive as any that exist and **would be infeasible** for most property owners without some form of subsidized financing. Property owners are required to install, before selling the building, any measure that is estimated to pay back in energy savings in 10 years or less. The requirement will not apply to actual building sales until 1985. Subsidized financing is available. Both local utilities—Pacific Power & Light (PPL) and Portland General Electric (PGE)—offer free audits and zero interest loans, with repayment upon sale of the home, to single-family owner-occupied units. PGE had completed 6,100 audits (out of 7,200 requests) and 3,350 customers have undertaken weatherization. PPL has not broken out data for Portland, but its activity level has also been high. Zero interest loans in both cases have been in the \$1,500 to \$1,600

<sup>6</sup>Alschuler, op. cit., p. 32.

range and the participants in the program have mostly been middle- and upper-income customers.<sup>7</sup> However, the program is limited to owner-occupants whose financial capacity allows them to support additional debt. This covered only about 12 percent of the units in the city.

To reach other single-family homes, the vast supply of rental housing, and commercial and industrial properties, Portland Energy Conservation, Inc. (PECI), the not-for-profit corporation set up to administer the program, assembled a \$15 million loan pool provided by 12 local lenders and **supplemented** by a \$3 million urban development action grant (UDAG). The package includes the following financing: zero interest 1-year loans to businesses and investor-owners of residential properties for audits. In addition, PECI will offer rebate of audit costs for businesses that invest in retrofit measures recommended in the audit:

<sup>7</sup>Both, et al., op. cit., pp. 6-14.

- 3 percent interest loans for retrofit **for** eligible low- and moderate-income families, and a hardship waiver **for households whose income is 50** to 80 percent of the median and who spend more than 25 percent of their income for housing.
- An interest subsidy to lenders to pay the difference between the market interest rate (currently 16 percent) and the subsidized rate of 8 percent. This subsidy is designed to increase access to private financing for Portland residents who may not be eligible for other subsidies. This same subsidy program is available to multifamily owners.
- Loans of 3.5 percent interest to landlords whose tenants are primarily low and moderate income.

These programs were developed in part to supplement utility audit financing and also to fill in the vacuum left when a State loan program which subsidized rates down to 6½ percent went defunct. Under the State program, lenders would be subsidized in the form of a tax credit down to a 6½ percent rate. The hitch was that there is a 12 percent ceiling on loans when State funds are involved and when interest rates zoomed beyond this limit, lenders were not interested. There are efforts now to make the ceiling more flexible so that this program can be revived as yet another subsidy option. Similarly, while the city programs are directed almost exclusively toward single-family and multifamily owners, commercial property owners are expected to finance improvements on their own. The city expects to extend its retrofit incentive programs to commercial property owners in the future, however.

Since December, when the single-family program was launched, about 700 homeowners have requested audits under the program. It is much too early to know how widespread the program will be, but the Portland approach can certainly provide an excellent test of whether the code/finance mixture is successful in reaching a variety of urban building types. There are several factors in favor of the Portland approach. Perhaps the most important is the widespread participation of the private lending community in the program. Twelve lending institu-

tions set up the loan pool at a hefty level—close to \$15 million. Not only does this expand the financing opportunities but it also may encourage greater participation of commercial and multifamily owners who are often leery of pure government programs. “One of the reasons we have been successful thus far,” notes Steve Chadima of the Portland Energy Office, “is that we have gotten participation up front from these lenders.” Beyond the private participation in the program, is the wide range of financing incentives available. Chadima says Portland’s package is “one of the most enticing smorgasbords for **energy available anywhere,**” and he is **probably right. True, Portland does hold a stick over building owners,** in the form of the mandatory retrofit requirement, but between the city, the lenders, the utility, and possibly the State, there is certainly an abundance of carrots.

### Minneapolis: Low Cost Loans for High Cost Energy Improvements

Minneapolis has set an ambitious retrofit goal—and adopted a sophisticated strategy **for reaching** it. The objective is a 30-percent reduction in residential energy use by 1990. Meeting this objective will require (among other things) reducing energy use in four out of five homes by 45 percent. \*

The chosen instruments for this effort are the Neighborhood Energy Workshop and the Energy Bank. The entire program draws upon the early and aggressive involvement of the State of Minnesota and the city of Minneapolis in conservation efforts, the strong tradition of public service and private sector cooperation in solving Minneapolis community problems, and a lot of learning from conservation experiments across the country.

The Energy Bank itself will finance retrofits up to **\$3,000** per home. Funding comes from a revenue bond issued by the city, which in turn was used to establish a tax-exempt line of credit at a consortium of 17 **banks.** The banks agreed to

\*This account was based on data supplied by Ken Nelson of the Minnesota House of Representatives and phone conversations with Sheldon Strom, Minneapolis. City Energy Coordinator and Eric Nathanson, Minnesota State Housing Authority.



provide the city with a 10-year line of credit at 10 percent interest. This means that loans can be financed at 11 percent **for 10 years—almost unheard of capita! cost rate in 1981. Minnegasco (Minnesota Gas Co. ) the local gas utility, originates all loans, and services the loans through its monthly billing operations. (Thus, the banks have no servicing costs. ) As an additional incentive to conserve, Minnegasco also provides participating customers with a rebate of up to \$100** for their installation of approved energy saving equipment. Qualifying improvements have a simple payback of 10 years or less. All Minnegasco customers in good standing are eligible for Energy Bank loans, following an audit by Neighborhood Energy Workshop or the area Residential Conservation Service (RCS) audit.

The *Neighborhood Energy Workshop* has been designed to maximize the use of scarce resources (auditors and time of residents, as well as tools) and build momentum through personal involvement. Workshops vary slightly for three basic groups of consumers; they differ by income category. Each workshop is based on block participation; a certain number of participants must attend the workshop to make the block eligible **for the audit and an** Energy Bank loan. Higher levels of participation are required as incomes rise.

Following intensive advertising, phone calls, and the distribution of leaflets and materials on the block, participants come to the Saturday

morning workshop with a completed audit form of their own house. Along with coffee and doughnuts, they hear a presentation on various techniques of saving energy in Minneapolis homes, including both changes in the way they use energy and technical solutions. Materials and some tools are distributed at the workshop. In the afternoon, people work on their individual homes, with neighbors and program staff helping those who cannot do their own work. The auditors go from house to house, armed with the audit forms submitted in the morning. Each occupant is expected to meet the auditor at the door with energy bills, a tape measure, and a flashlight. The auditor then moves through the home as quickly as possible, looking for unusual problems and reviewing the standard items covered in the audit sheet. **A** separate appointment is made for a Minnegasco service representative to check the heating system. The audit techniques have been **influenced** by the work at Princeton University developing "house doctor" techniques for efficient audit and retrofit.

The Minneapolis program has been built up gradually, so that audit techniques and workshop routine could be tested. A small-scale effort the first year **covered 1,800** households, or about 150 blocks. The city hopes to expand the program to **500** or 1,000 blocks in 1982. Most resources will be directed to lower income areas, but the idea is to provide help in saving energy in many neighborhoods.

## RETROFIT AND REHAB: A TALE OF THREE CITIES: PITTSBURGH, BOSTON, BALTIMORE

Most cities operate programs to rehabilitate and conserve existing housing. Usually these programs are tied to code enforcement and are designed to bolster available housing for low- and moderate-income residents. Rehab programs are generally funded out of Federal moneys—Community Development Block Grant (CDBG), sections 312 and 8, among other programs. Regulations encourage the use of such programs in part for **energy conservation**. But

there are many claims on the rehab dollar and usually energy is not the top claim. In the typical list of priorities for rehab repairs, code enforcement will come first. Then may come exterior repairs to help improve the overall neighborhood ambience. And then may come energy. Or once code violations have been addressed, there may not be any explicit ordering of repairs. Only in a few cases is energy conservation an explicit and high priority **for the rehab dollar**.

The combination of retrofit and rehabilitation is important for several reasons. First of all, in most cases, the ceiling on rehab financing is much higher than for energy conservation repairs alone. This means that many important retrofit measures, such as upgrading heating systems become feasible under rehab programs whereas they could not be attempted with lower level energy loans and grants. This higher threshold is particularly important when it comes to multifamily properties. But even **more important, retrofit cannot be isolated from major repairs** in some of the most seriously deficient housing. What good is insulation or a new storm door, when a roof is in total disrepair? Yet, the typical weatherization program cannot touch such major deficiencies. These are the province of the rehab program. **When the two are combined**, as they are in a few places, energy conservation and rehabilitation can work in concert.

### Pittsburgh

One of the Nation's largest and most successful rehab programs is operated in Pittsburgh, Pa. \* From 1975 to 1980 the Pittsburgh rehabilitation program made over 5,600 loans for general rehabilitation of owner-occupied property and over 600 loans for rental property rehabilitation. In addition, there were more than 600 loans for emergency repairs (to correct dangerous code violations, etc.). This program also has an important energy component. This year, Pittsburgh will allocate \$600,000 in CDBG funds to its "rent break through energy conservation" program. Under the program, owners of buildings with from 1 to **25** units can receive an outright grant of up to **\$2,000** a unit for energy improvements. occupants of the building must fall within section **8** limits (with incomes at or below 125 percent of the poverty threshold) and the landlord must agree to hold rents constant for up to 2 years. Since March 1980 when this program was started, **505** dwelling units in **285** buildings have been retrofitted.

\*This account was based on interviews with Paul C. Brophy, director and Norma Sue Madden, real estate analyst in the Pittsburgh Department of Housing; and on an unpublished summary of the Pittsburgh rehabilitation program, Office of Community Planning and Development, HUD (undated).

Virtually any energy improvement, including tenant metering, is eligible under the program. However, grants are approved only after a city inspection and first priority goes to measures to improve efficiency, such as insulation, caulking, and storm doors. The limit on the grant amount is \$50,000 per building.

Another city rehab program for rental housing improvement allocates grants of up to \$5,000 a unit for general rehab, upon execution of a rent limitation agreement. This program, funded out of \$2 million in CDBG funds, is designed to reach buildings whose occupants are primarily low-income tenants. City regulations require that energy conservation be included in the rehab work.

The city's most extensive rehab program is oriented toward the homeowner and funded out of an \$11 million tax exempt bond issue and CDBG funds. Twelve local lenders originate and service loans to eligible homeowners. The loans are secured by the Federal Housing Administration, title insurance and bought by the Pittsburgh Redevelopment Authority. In the regular loan program, the banks originate loans at 9 percent which are then subsidized by the authority down to 4 percent for homeowners with incomes below section **8** limits (see ch. 9). Properties must be in designated target areas of the city. The authority also administers a special loan program to people whose income falls below \$7,000. The authority may forgive up to 100 percent of the principal, depending on the income of the recipient. Energy conservation is a required improvement under both programs. In addition, the authority provides \$400 home insulation matching grants to recipients of regular and agency loans. There were 1,500 such matches in 1977-78. The average amount for loans under this program is \$12,000 per unit.

### Boston

In Boston, the city weatherization program (WIP) has supplanted Boston's Home improvement program as the city's main housing rehabilitation activity. \* Under this program, funded

\*This account was based on information supplied by Karen Sumarborg, planning director, Mayor's Office of Housing, Boston.

by \$5 million in CDBG funds during its first year, the city provides free energy audits and rebates to owner/occupants of one- to six-unit properties for energy improvements. Virtually the whole city is covered by the program, which is operated out of 10 housing site offices scattered throughout Boston.

Under the program, an applicant applies for an energy audit performed by the city which does a work writeup of eligible improvements. The city will fund any code-related repair related to energy efficiency. At a minimum, this includes attic and wall insulation, weather stripping, caulking, and smoke detectors (the last is a nonenergy requirement included in this program). The applicant then arranges **for** conventional financing from one of several lenders participating in the program. These lenders have been providing financing at about 1 percent below the going rate for energy improvements. After the work is completed and certified by the city, it provides a rebate ranging from 20 to 40 percent of the cost, depending on the income of the applicant and the extent to which tenant units are involved.

The WIP program began in September 1980 and about 1,400 free audits have been requested since then. There have also been approximately 700 applications for rebates as of the end of March 1981.

Much of the groundwork for WIP was laid by the city's earlier rehab program, Home Improvement Program (HIP). Between 1965 to 1981 when that program was in operation, close to 17,000 cases were handled. HIP helped get word out to the public about the city's role in rehab financing. More importantly, staff developed a close working relationship with local lenders. Today, banks that participate in the program consider the rebate program when they underwrite home improvement loans, thus making this sort of financing **more available than** in many other cities, particularly for **moderate-income** households.

Boston housing officials have tried to make the program as attractive as possible to small multifamily owners. Moderate-income owner occupants receive a 20-percent rebate on the

cost of improvements to their unit and a 40-percent rebate on improvements to tenant units. Low-income owner occupants receive a 40-percent rebate for their units and a 40-percent rebate for tenant units. The ceiling on construction costs starts at \$5,000 for a one-unit building and goes to \$15,000 for five-to six-unit buildings. Based on the experience with HIP, under which terms were basically the same, Boston officials expect that more than half the applicants under WIP will be small multifamily owners. Under the previous program, about 10 percent were in fact owner-occupants of five- to six-unit properties. Boston officials would also like to expand the program to commercial buildings and are hoping that the loan amount and the size of the rebate will make the program attractive to such property owners.

### Baltimore

Baltimore also offers a special energy incentive program as part of its rehab activities. \* Called the "energy loan," **it provides** 11½ percent 7-year loans between \$500 to \$3,500 for a range of retrofit measures, including insulation, storm windows, solar units, and replacement of burners. Tenant meters, fireplaces, heat pumps, and upgrading of interior windows are not eligible under the program. The energy loan is limited to owner-occupied one- to four-unit **properties, and** has been funded out of a \$2 million municipal bond issue. Loans are issued through four participating private lenders, after an evaluation of the application by the city.

While WIP has **become** Boston's major rehab activity, the "energy loan" is only one of several rehab options in Baltimore. The city has an active 312 program, and several loan and grant programs for low- and moderate-income applicants funded under Federal, State, and local auspices. The energy loan can be coupled with these other rehab programs and there is nothing that prevents someone from using other city **incentives for energy improvements. However, the energy loan** is the only city rehab program

\*This account was based on information supplied by Anna Baumann, assistant to the Mayor's Energy Coordinator, Mayor's Office of Housing, Baltimore.

that uses private lenders, and it is explicitly designed to handle smaller, energy-related jobs. The Baltimore program was just launched and it is impossible to get a sense of what activity under it will be. The program does not offer

special incentives to multifamily owners. While it would certainly like to reach such property owners, the program is really designed to assist owners or the smaller properties that make up most of this city's housing stock.

## LARGE-SCALE RETROFIT: PROSPECTS IN FIVE TYPICAL CITIES

To gain a better understanding of the diversity of local retrofit environments, OTA prepared case studies of five cities that are broadly representative of different types of large communities around the country. None are especially known for energy programs. The cities are: Buffalo, N. Y.; San Antonio, Tex.; Des Moines, Iowa; Jersey City, N. J.; and Tampa, Fla. The cities not only vary by size, region, and climate, but also by economy, governance, predominant housing type, and primary heating fuel. They all have some energy conservation activity going on, but the catalysts for the activity, and its precise nature and impact vary substantially. The cities were deliberately selected to reflect the range and variations in American cities.

Basic information can be found in tables 84 through 88 on each city's climate, population, housing stock, energy prices, and local housing and energy programs. The appendix at the end of the chapter has further information on the nature of the housing stock and types of heating and cooling system in each city.

The case studies are based on extensive interviews conducted in person and by telephone by an OTA team during the fall and winter of 1980-81. These interviews were supplemented by background material provided by local sources and by OTA staff research.

This chapter summarizes the material in a set of longer case studies to be published as "Volume 11: Working Papers." All sources for the

**Table 84.—Population Indicators: Case Study Cities**

|   | Tampa          | Buffalo        | San Antonio    | Jersey City    | Des Moines      |
|---|----------------|----------------|----------------|----------------|-----------------|
| 1975 population . . . . .   | 280,340        | 407,160        | 773,248        | 243,756        | 194,168         |
| Change, 1970-1975 . . . . . percent. . . . .                                    | 0.9            | -12.0          | 9.1            | -6.4           | -3.6            |
| <b>Population, 65 and above (1970) . . . . . percent. . . . .</b>               | 12.4           | 13.3           | 8.4            | 11.3           | 9.8             |
| <b>Median family income (1969) . . . . .</b>                                    | <b>\$7,677</b> | <b>\$8,794</b> | <b>\$7,731</b> | <b>\$9,305</b> | <b>\$10,238</b> |
| <b>Households below poverty level (1969) . . . . . percent. . . . .</b>         | 14.9           | 11.2           | 17.5           | 10.3           | 6.9             |
| Households below 125 percent of poverty level (1969) . . . . . percent. . . . . | 20.9           | 16.1           | 24.5           | 15.1           | 10.5            |

SOURCES: County and City Data Book, 1977; U.S. Department of Commerce, Bureau of the Census.

**Table 85.—Climate Data: Case Study Cities**

|   | Tampa | Buffalo | San Antonio | Jersey City | Des Moines |
|---|-------|---------|-------------|-------------|------------|
| Mean January temperature (°F)   | 60.4  | 23.7    | 50.7        | 31.0        | 19.4       |
| Mean July temperature (°F) . . . . .                                  | 81.9  | 70.1    | 64.0        | 74.8        | 75.1       |
| Mean annual possible sunshine <sup>a</sup> . . . . . percent. . . . . | 67.0  | 50.0    | 64.0        | 60.0        | 62.0       |

<sup>a</sup>Mean annual possible sunshine is the relationship between the number of hours of sunshine as recorded by instrument at stations having automatic sunshine recorders for a considerable period of time and for which records have been summarized, and the number of hours between sunrise/sunset for each day during the year.

SOURCES: County and City Data Book, 1977; U.S. Department of Commerce, Bureau of the Census.

**Table 86.—Average Residential Gas and Electric Rates: Case Study Cities**

|                                    | Electric<br>cents/kWh | Gas<br>cents/therm |
|------------------------------------|-----------------------|--------------------|
| Jersey City <sup>a</sup> . . . . . | 8.0                   | 52.0               |
| Buffalo <sup>bc</sup> . . . . .    | 6.0                   | 46.0               |
| Tampa <sup>de</sup> . . . . .      | 5.8                   | 47.0               |
| San Antonio <sup>f</sup> . . . . . | 4.5                   | 23.5               |
| Des Moines <sup>g</sup> . . . . .  | 6.0                   | 38.0               |

NOTE. All rates are averages and include adjustment and service charges

SOURCES

- <sup>a</sup>Public Service Electric & Gas Co. Average residential rate as of Apr 17, 1960.
- <sup>b</sup>Niagara Mohawk power Corp Average residential rate, based on 500 kWh/month usage as of Mar 18, 1981 rates
- <sup>c</sup>National Fuel Gas Average rate as of February 1980
- <sup>d</sup>Tampa Electric Co Average rate as of November 1979.
- <sup>e</sup>Peoples Gas System, Inc Average rate as of 1977
- <sup>f</sup>City Public Service Board: Average residential rates as of July 1981 Average gas rates as of September 1981, but gas rates change monthly, depending on transport costs and other factors, as allowed by State regulations.
- <sup>g</sup>Iowa Power: Rates are 12 month averages as of Sept 30, 1981

material summarized here can be found in the full case studies.

What emerges is a picture of retrofit activity in a particular city at a particular time. The “particular” is important to emphasize. The reader should be wary of generalizing from these cities. Rather, the message that should be drawn from these case studies are the many possible variations and combinations that can help induce retrofit in the urban setting.

**Buffalo**

In Buffalo, energy conservation is widely recognized as an important local issue by many groups in the city. But energy is only one of

**Table 87.—Housing Characteristics: Case Study Cities**

|                                  | Tampa   | Buffalo | San Antonio | Jersey City | Des Moines |
|----------------------------------|---------|---------|-------------|-------------|------------|
| Total housing units . . . . .    | 100,857 | 166,142 | 203,226     | 91,997      | 72,349     |
| Occupied housing units . . . . . | 94,889  | 157,951 | 190,692     | 87,853      | 68,506     |
| Owner-occupied . . . . .         | 63,921  | 69,453  | 118,922     | 24,697      | 45,408     |
| Percent . . . . .                | 67.4    | 44.0    | 62.4        | 28.1        | 66.3       |
| Renter-occupied . . . . .        | 30,968  | 88,498  | 71,770      | 63,156      | 23,098     |

SOURCE 1970 Census, Detailed Housing Characteristics

**Table 88.—Federally Assisted Housing and Energy Program Activity: Case Study Cities**

|  | Tampa              | Buffalo             | San Antonio         | Jersey City      | Des Moines         |
|--|--------------------|---------------------|---------------------|------------------|--------------------|
| Housing rehabilitation (1977-80: units) . . . . .                | 535a               | 4,400 <sup>b</sup>  | 739 <sup>c</sup>    | 800 <sup>d</sup> | 445 <sup>e</sup>   |
| Weatherization (1977-80: units) . . . . .                        | 400 <sup>f</sup>   | 1,1359              | h                   | 62 <sup>i</sup>  | 1,511 <sup>j</sup> |
| Low-income energy assistance (1980-81: aid recipients) . . . . . | 1,360 <sup>k</sup> | 49,167 <sup>l</sup> | 50,784 <sup>m</sup> | n                | 6,345 <sup>o</sup> |

SOURCES

- <sup>a</sup>City of Tampa Energy Conservation Coordinator Covers period July 1975 to September 1980 and includes only community development block grant program
- <sup>b</sup>Buffalo Neighborhood Revitalization program Yearly breakdowns for the period are: 1977: 400; 1978: 1,100; 1979: 1,200; 1980: 1,700 Totals include sec. 312 and community development block grant programs
- <sup>c</sup>San Antonio Development Agency: Represents community development block grant, sec 312, emergency home repair and moderate-income rehabilitation programs Yearly totals for the period are: 1977: 183; 1978: 187; 1979: 165; 1980: 204.
- <sup>d</sup>Jersey City Department of Planning: Approximate total for 1979-81. Includes community development block grant, sec. 312 and 8, rehabilitation totals
- <sup>e</sup>City of Des Moines Neighborhood Development Administrator 157 homes were rehabilitated under the sec. 312 program between 1977-80. yearly breakdowns are the following: 1977: 16; 1978-79: 59; 1980: 65. In 1980, 268 homes were rehabilitated with community development block grant funds
- <sup>f</sup>Community Action Agency of Hillsborough County, Covers period June 1976 to March 1981. Yearly totals are the following 1976-78 191, 1979: 72, 1980: 84; 1981: 53 Totals are for Hillsborough County.
- <sup>g</sup>New York State Department of State, Office of Economic Opportunity Yearly totals for the period are: 1977: 100; 1978: 0; 1979: 592, 1980: 443
- <sup>h</sup>No program
- <sup>i</sup>New Jersey Department of Energy, Office of Low-Income Energy Conservation: Represents completed units for 1960 only.
- <sup>j</sup>Capital View Housing Center and Des Moines office of Neighborhood Development: Yearly breakdowns are: 1977: 148; 1976: 434; 1979: 166; 1960: 763
- <sup>k</sup>City of Tampa Energy Conservation Coordinator
- <sup>l</sup>Erie County Department of Social Services: Figures are for Erie County for period, Oct 1, 1980 to Apr. 17, 1961.
- <sup>m</sup>Texas Department of Human Resources: In 1980, 45,984 households received home energy assistance for heating in Bexar County; in 1960, 4,800 households received home energy assistance for cooling For the latter, only persons 65 and older are eligible for assistance The heating figures are for the period Jan 1 to Mar. 31, 1981, cooling totals are for August to September 1961
- <sup>n</sup>Not available.
- <sup>o</sup>Des Moines office of Neighborhood Development

many challenges confronting government and the citizenry in Buffalo. The others include high unemployment, a deteriorating city infrastructure, an old and dilapidated housing stock, and a largely low-income and elderly population with many social service needs. The average residential customer gas bill in Buffalo was almost \$700 for 1981. (Gas is the predominant home heating fuel.) However, more than 30 percent of Buffalo's population has incomes of less than \$10,000 and within this income group, energy costs can come to as much as 30 percent of income. Electricity costs in Buffalo are about \$0.45/kWh, right in the middle nationally, but the utility has requested a major rate increase, so many commercial customers that rely on electricity will also feel the brunt of rising energy costs. Buffalo's average winter temperature is about 24°, but the city is one of the windiest in the Nation.

There have been three types of responses to rising energy costs. The first is to shift the blame to the utility. An active citizens group in Buffalo, People's Power, has loudly advocated a municipal utility in the belief that such an institution would bring lower rates. Other citizens groups and the mayor have opposed rate increases for both gas and electricity. For their part, Niagara Mohawk and National Fuel Gas, the main ener-

gy suppliers, both run large-scale audit programs and offer low cost loans, but find that public response has been quite small and largely limited to middle-income households. Of 460,000 National Fuel Gas customers in western New York, slightly more than 3,200 have requested audits since 1977 and only 564 loans have been made. Utilities must offer audits and 11 percent 7-year loans under the State's Home Insulation and Energy Conservation Act. In the case of both Niagara Mohawk and National Fuel Gas, however, the utilities also see energy conservation as in their own best interest. For Niagara Mohawk, the objective has been to defer capital expense for additional generating capacity. For National Fuel Gas, it has been effective public relations.

City government programs have been the second response to rising energy prices in the city. The city has passed a resolution targeting some of its \$24 million in CDBG funds specifically for energy conservation. The city offers tax abatement/exemption for 80 percent of the cost of energy conservation improvements in multifamily buildings over a period of 10 years. Eleven multifamily owners (representing more than 200 units in all) have applied for such tax relief since November 1, 1980. The city has audited several municipal buildings and make

### Box P.—Buffalo

Buffalo is an aging Northeast port city, with a weak economic base and a steady drop in population. At the time of the case study visit, the unemployment rate was almost 9 percent, second only to Jersey City among the case study cities. Much of the city's population is below the poverty line; more than one-quarter of the households are headed by retirees. The majority of the housing stock, mostly wood-frame single-family homes, was built before 1939. Much of it is in poor condition. Buffalo's economy has suffered serious erosion and between 1973 and 1979, 75 factories in the area closed and some 17,000 jobs were eliminated. Moreover, the backbone of Buffalo's current job base, the automobile industry, is a troubled sector of the national economy. The key civic issue in Buffalo is economic development.

But there is another side to Buffalo. It is embodied in the current mayor, a man of infectious optimism whose spirit has reinvigorated the city and its citizenry. While many might describe Buffalo as a dying city, the mayor refuses to give up. A recent \$16.5 million UDAG will help finance a new hotel and two downtown office buildings. Luxury townhouses are going up in a center city waterfront site. Several other downtown office buildings have been constructed. While most of the neighborhoods in the city badly need help, Buffalo has its chic urban revitalization areas that have attracted boutiques, restaurants, and urban brownstoners. Through an aggressive housing rehabilitation program that emphasizes exterior facelifts as much as code enforcement, the mayor hopes to revive other neighborhoods in the city as well. Buffalo is a city of strong ethnic neighborhoods and has several active community groups.



some energy improvements under its capital budget program, although these resources are quite limited. Both the school district and the housing authority have taken major initiatives to cut energy costs. The city allocated \$4 million of public works funds to the school district for the purpose of retrofitting school buildings. Public building energy costs have increased dramatically in Buffalo and are of great concern to the city whose budget is severely strained from several other quarters as well.

Buffalo has a large older and deteriorated housing stock, primarily of wood frame construction. Local officials estimate that there are about 30,000 dwellings in **need of weatherization, of which 10,000** are occupied by low-income households. The city has an active rehab program and works closely with local lenders, such as the Buffalo Savings Bank, to finance housing improvements. While there is concern over energy by local housing officials, funds are only now seriously being directed to retrofit. The main emphasis in the program thus far has been on code enforcement and exterior improvements. The weatherization program run by the local poverty agency, has **been ham-**



*Photo credits Office of Technology Assessment*

In the winter, cold winds blow from the west across Lake Erie into downtown Buffalo chilling Buffalo's housing stock of densely packed frame buildings



Photo credit: Office of Technology Assessment

The Buffalo Savings Bank (buildings on left) and Niagara Mohawk Electric Co. (right) have both developed programs to stimulate retrofit of buildings

pered by administrative problems and has weatherized only a few hundred structures since 1977. Energy problems have been tackled most aggressively in Buffalo from outside of government, particularly by nonprofit groups and energy conscious designers. These energy activists have worked closely with government and the utility in several cases. The New York Public Interest Research Group (NYPIRG), working with National Fuel Gas, conducted 1,250 audits in low-income homes in a year, and has run several training programs through the community development program to teach low-income residents about energy conservation. Another nonprofit group, the Buffalo Energy Project, has worked with local builders

to develop luxury solar townhouses on the city's waterfront and with the city to place a windmill in Naval Park. A downtown business group is also cooperating with the city and the local housing authority to recycle an abandoned public housing project into an energy efficient low- and moderate-income residential development. In addition, local architects and engineers have designed several downtown buildings using innovative energy technology, including solar units and heat pumps. In general, however, the older office buildings that dominate Buffalo's downtown have lacked sufficient cash flow to consider major energy improvements, even though they are caught in a tight competitive race for tenants with newer, more energy efficient buildings now being built downtown.

The reinvigorated downtown is symbolic of the third response by the city to its energy needs. This response is best summed up by an assistant to the mayor who observes: "The city's approach is to attack economic development issues and to bring more money to Buffalo. That is how we are attacking the energy problem." Thus, in the city's housing program, rehab funds are assigned first to correcting code violations and then to exterior beautification. Only if money is left over does energy get addressed, unless it is associated with code violations. The theory is that if neighborhoods have a more positive physical environment, then investment dollars will start to flow into them. Similarly, the mayor has devoted considerable attention to garnering Federal funds, such as UDAGs, for downtown improvement. The city is building a single line subway system. It has also submitted an application to study the feasibility of a downtown district heating system that would be tied into downtown development.

Buffalo's progress in retrofit will probably be slow but steady. Large numbers of buildings are not likely to be retrofitted in the near future. But the city and the nonprofit community in particular have established a framework for a working relationship that appears to be leading to small but positive steps to making many of the buildings in the city more energy efficient. Both utilities are committed to their audit programs



and are bound to reach a substantial share of their customers over time.

### Des Moines

Des Moines is an extremely cold city during winter months and more than **50** percent of the city's housing was built before 1940. The city

has recently felt the shock of some large utility rate increases. In January 1981, Iowa Power & Light put into effect a 14 percent electric rate increase and a 6 percent natural gas hike. Residential fuel use is about evenly divided between the two. Despite these factors", energy conservation has not been an important local issue in Des Moines and is not likely to be.

### Box Q.-Des Moines

**Des Moines is a medium-size Midwest regional center. The city is relatively prosperous, with a strong economy and a low unemployment rate. Downtown Des Moines is vibrant, with much new office construction. The city has a strong service sector and is a center for insurance and publishing, among other businesses.**

**Much of the housing in Des Moines was built before 1940 and the majority of this older housing stock is of wood-frame construction. However, because of the relative affluence of the population, housing is generally in good condition. There are few multifamily buildings in the city although there is expected to be more such housing in the future.**

**Neighborhood groups in Des Moines are not particularly strong, but the business community is. The Des Moines Housing Council has taken an active role in downtown development and housing issues. The lending community also seems to have a strong community spirit.**

**Des Moines has a strong city manager and issues of management and planning are important in this city in both the public and the private sector.**



*Photo credits: Office of Technology Assessment*

Downtown Des Moines is prosperous and the business community is active in civic affairs. The largely single-family wood frame housing stock is kept in good condition by a relatively affluent population, and is already fairly energy efficient

First of all, the city is relatively prosperous. Unemployment is low and household income is high. Second, even with the hikes, utility rates are not especially onerous. Average home heating bills range from **\$464 to \$600 annually. And perhaps most important, Des Moines residents have already made many of the retrofit improvements necessary to survive in a climate** where winter temperatures average under 20° F. Iowa Power & Light, the major utility, estimates that about 50,000 customers have made energy saving improvements since 1973, although only a fraction (3,000) have taken advantage of the utility's 9 percent 3-year loans.

Interest in energy conservation in Des Moines is diffuse. Citizens have dealt with the need for energy retrofit in a self-reliant, independent fashion that characterizes much of the activity in this city. Homeowners and businesses have taken the necessary steps to make their buildings more energy efficient both for survival in the harsh climate and for competitive business reasons. Assistance has come not from government, but rather from the utility and local lenders. Des Moines Savings has a nationally recognized lending program for energy conservation that offers loans of up to \$2,000 at 1 percent below the market interest rate. In addition, energy efficiency is an important part of the savings and loans' underwriting standards and as a result of its appraisal policy and its low-interest loans, about 4,000 customers have taken advantage of Des Moines Savings financing for energy improvements since 1977. Other banks in the Des Moines area are also beginning to push energy conservation in their lending programs, although none have gone so far as Des Moines Savings. Commercial building owners in Des Moines have also taken basic energy saving steps, both for cost savings and to keep pace in a highly competitive office market with much new space going up. The presence of the State capitol, with some solar demonstrations on State buildings and an active State energy program, has also helped to spur private interest in retrofit.

City government in Des Moines has a strong interest in conservation. It has a national reputation as a well-managed city and energy has

grown in importance for the city manager and his staff. This year energy expenses will run \$4.5 million, second only to personnel, in Des Moines' expense budget. Tax revenues have been declining in the city and the State has imposed a 6-percent limit on growth in assessed valuation for 1980-81 and a 4-percent limit for 1981-82. The city has been forced to use general revenue sharing funds normally reserved for capital improvements for its operating budget. Thus, reduction of operating costs, such as energy, is a high-priority managerial item.

The manager has set up an energy policy committee to set specific goals for each department. The committee has organized building energy squads, cut down on the fleet, and purchased more energy efficient equipment. The city engineer has completed audits in several buildings and is programming capital improvements within the tough constraints of the budget.

Des Moines has also taken a strong management approach to helping low-income families deal with energy problems. There are about 20,000 low-income families in the city and they live in older, poorly insulated units. The city has its community development and antipoverty programs in one department, which makes for an efficient delivery center for energy programs designed for the poor. Direct cash assistance and weatherization programs are well organized and coordinated in Des Moines in contrast to most cities. The weatherization program has reached more than 1,200 homes in the last 3 years and about 4,400 families have received cash assistance. The city has also run smaller demonstration programs for both conservation and solar in conjunction with local community groups. The rehabilitation program is oriented primarily toward code enforcement, but lack of storm windows and ceiling insulation are considered code violations and would be covered under the program. Future plans for the rehabilitation program call for even greater attention to energy conservation and an expansion to multi-family buildings.

One goal of city officials is to set an example for the rest of the citizenry in terms of conserva-

tion. Thus far, they have an issue without a following. The planning director, who heads the energy committee, and at least two public interest groups, have tried to fan interest in energy conservation in Des Moines. There has been talk of developing a community energy plan and instituting a retrofit requirement for existing housing. But public interest in making energy conservation a high visibility political issue has been small. Perhaps this is because the most necessary retrofit work in Des Moines has already been done.

### Tampa

Tampa's benign climate and its relatively new building stock have somewhat mitigated the impacts of high energy costs. Rising costs have been felt, however, by the city government, which is just pulling out of a fiscal crisis and by low-income households in the city, about one-third of whom are elderly.

However, conservation activities in Tampa largely emanate from Tampa Electric Co. (TECO) and they are aimed at the middle class new home buyer or builder. TECO's interest in turn is sparked by an extremely aggressive State Public Service Commission (PSC) that adopted stringent rules in September 1980 to reduce the growth rate of electric consumption (especially weather sensitive peak demand) and the use of oil as a generating fuel. Under its rules, the PSC will review all proposed rate increases against

the utility's conservation record and measure conservation as an alternative to new power-plant construction as a means of "increasing" capacity. Under the PSC rules, TECO is being held to strict limits on increases in kilowatt demand and kilowatt-hour consumption; energy is allowed to grow at 75 percent of TECO's customer growth rate and demand at 72.25 percent of that. Utility officials are concerned by the growing gap between summer and winter peaks and project high winter peaks in the future. While industrial and commercial growth is expected, the largest new market and the biggest problems appear to be coming from new residential customers, a sector that is expected to continue to grow. So TECO has proposed a 7-point conservation strategy heavily targeted toward the new residential market. The strategy includes first cost subsidies for installation of heat pumps, discounts for high efficiency storage water heaters, an expanded audit program, and a test program for direct load management. TECO expects to place heat pumps in 2,000 homes each year for the next 5 years, a move that will reduce energy usage by as much as 60 percent in these residential units. It has also set a goal of 1,800 to 2,000 audits a year for the next 5 years.

The results from audits so far have not been encouraging. TECO has mailed out fliers to 42,000 customers with higher than average home energy usage, and has pushed audits through the media and mailings. About 1,800

#### Box R.—Tampa

Tampa is a well-established port city that benefited strongly from the spurt in southern regional growth, but more recently has seen major new development move out of the city to the broader metropolitan area. This shift in the city's fortunes has been reflected in a declining tax base, budgetary problems, and a growing consciousness of the importance of housing and neighborhood development. The city's mayor inherited a serious budget deficit his first year in office and has tried to put the city on a strong management-by-objective footing.

The shift in urban-suburban fortunes is reflected primarily in residential growth. Downtown Tampa is actually undergoing something of a commercial boom, with dramatic office and hotel complexes rising on several prime corners. The city's port is still active and Tampa has benefited from the overall tourist draw of the region, a fact that is reflected in the city's gleaming, ultramodern airport. The business community in Tampa seems strong and the chamber of commerce has played an active role in several areas, including energy. In contrast, neighborhood groups are very weak. The small public interest community is concerned primarily with environmental matters.



*Photo credits: Office of Technology Assessment*

Tampa's downtown is booming although residential growth continues to shift to the suburbs. Single-story bungalows are typical of Tampa's largely wooden housing stock

**customers have requested audits in the past 2 years, but there is no indication that they have followed through on recommendations. Interest from the existing home market has been particularly low, according to TECO officials and other Tampa energy experts.** However, a State energy efficiency code has helped to contribute to more energy efficient new buildings.

While TECO has not focused attention on commercial buildings in its market area, local business people have been quite concerned about the impact of rising energy costs. In a model program, the city's chamber of commerce has joined with TECO and the local engineering society to sponsor low cost audits for local businesses. The Hillsborough Energy Audit Team (HEAT) program is targeted toward local businesses whose utility bills are between \$1,000 to \$17,000 a month. In the first year of the program, about 60 firms—or 34 percent of those contacted—signed up for the program. The chamber expects to target HEAT to small businesses in the future. Followup has been a major problem with the program and, as with the TECO residential audits, it is not clear that building owners have actually implemented the recommended measures. In Tampa, financing for improvements such as retrofit is now two points above prime, more than many businesses can afford. On the other hand, the office market in the city is highly competitive and new buildings have to adhere to the strict State code. To keep pace with the market, owners of several older Tampa buildings have made energy-related improvements, such as replacing oversized air-conditioners and installing computerized energy management systems.

The other locus for conservation activity is city hall. Tampa has a managerially oriented mayor who inherited a heavy deficit and was forced to lay off a substantial number of city employees in his first months in office. The mayor has set fuel usage quotas for each city department and converted much of the fleet to sub-compact and propane powered cars and trucks. The city is using CDBG funds to convert street lights to high-pressure sodium vapor lighting to cut costs. The city has also conducted audits of several buildings and installed an

energy management system in the library. Both the housing authority and the school board have been energy conscious, and the housing authority has received several grants from the Department of Housing and Urban Development to experiment with solar applications.

Tampa has about 22,900 households that require housing assistance and an estimated 12,000 substandard homes. The county weatherization program has reached about 360 units in Tampa since 1976, but has been hampered by federally imposed limitations on supervisory personnel. City rehab programs do include some energy work, but the basic thrust of the Tampa rehab program is for major long-term improvements. The average loan is for \$17,000 and lasts 20 to 30 years. Very few homes are rehabbed each year, because of the attention given each unit, and the city's 3-year housing assistance plan sets a goal of only 141 rehab units.

In Tampa, public interest groups, lenders, and energy designers are not potent forces for conservation. The spur for large-scale retrofit is coming primarily from TECO and the chamber of commerce and it is contingent on private response. The prospects are summed up in a sobering comment contained in TECO's submission to the Public Service Commission:

**Although Tampa Electric is committed to enthusiastically pursue its conservation programs, it should be reiterated that the electric utility customers, and not the utility serving them, hold the real key to the success or failure of energy conservation programs.**

## Jersey City

Jersey City is a depressed Northeast city, with a large low-income population and a very poor housing stock. More than half the units in the city are heated by oil and consumers have experienced burdensome price increases in recent years. In 1980-81, the price of home oil heating increased by 50 percent.

The impact of energy has been felt throughout Jersey City. Housing officials attribute escalating abandonment of buildings to high energy

### Box 8.—Jersey City

At first blush, Jersey City is a dying mid-Atlantic city. But Jersey City has an advantage that most other similar localities lack. It is across the Hudson from midtown Manhattan and is about 10 minutes away from both Wall Street and Broadway, via a 30 cent PATH subway ride. Jersey City has overwhelming housing and community development problems, but the city is trying to capitalize on both its magnificent view and its proximity to New York to turn its fortune around.

At the moment this vision remains in the realm of dreamland. The city has a 10 percent unemployment rate and 30 percent of its housing units are substandard, with many in dilapidated multifamily buildings. Industry has fled the city to the attractive industrial parks in the Hackensack Meadows and other areas. Some neighborhoods show signs of a brownstone revival, but most are extremely poor in both spirit and condition. Jersey City's municipal government has tried to cope with these problems with a strong spirit, but the city is hamstrung by serious fiscal problems, exacerbated by a rapidly eroding tax base. Neighborhood groups and the business community appear dispirited.



Photo credit: New Jersey Bureau of Neighborhood Preservation

Jersey City's population is largely housed in small- and moderate-sized masonry multifamily buildings

**prices.** The code enforcement bureau has experienced a 50 percent increase in complaints for heat shutoffs from 1980 to 1981 (from 2,400 to almost 3,400). Credit terms have been tightened on oil deliveries. Federal cash assistance applications far exceed the capacity of available funds.

The problem in Jersey City is exacerbated because much of the population are renters in older multifamily buildings and neither the building owners nor their tenants want or can take responsibility for retrofit. Everyone is concerned about energy in Jersey City but in this predominantly low-income community few have the resources to do much about it.

That puts a heavy responsibility on government. Jersey City has a tough code enforcement program that includes both a housing court and receivership action. But many landlords would sooner abandon the building than make improvements that they cannot afford. The city also has a rent control ordinance that allows only limited increases for higher energy prices. In any case, much of the low-income tenantry could hardly afford higher rent.

The city has tried to address energy conservation in the context of overall housing problems that are extremely serious. The Jersey City Redevelopment Agency (JCRA) offers a 30-percent grant to homeowners and owner-occupied one- to four-family properties for correcting code violations and making major property improvements. The maximum grant is \$20,000 for a four-family building. In three of the city's neighborhood preservation areas, JCRA also offers a 50-percent grant for multifamily properties with low-income tenants, up to \$500 a dwelling unit. Repairs are for housing code violation, barrier removal, energy conservation and cost-reduction measures, in that order. About 837 loans and grants have been made by JCRA. Jersey City also has a home improvement grant program available for owner-occupied one- to four-family dwellings in other parts of the city, which can either be a match or an outright grant (for very low-income households). In 1981, the city will earmark \$200,000 of CDBG funds specifi-

cally for energy conservation measures under the program. The volume of Federal weatherization activities in Jersey City has been very low, only 62 units completed in all of 1980.

Energy has been a serious problem in city buildings but without Federal or State funds to defray the cost of capital improvements, the city can do little within its budget constraints to tackle retrofit projects. The main government activities have been public relation campaigns aimed at city employees and local residents. These have generally met with poor response. The business community in Jersey City has also been very unresponsive. There is little competitive pressure for improvements in the office or commercial markets. Banks and energy suppliers have shown little interest in actively promoting conservation; also energy has not been an important issue for public interest and neighborhood groups.

As in Buffalo, the mayor has decided that energy is best tackled as part of the city's overall economic environment. Jersey City is working with Public Service Electric & Gas (PSEG), the major electric utility, to develop a district heating plant for the downtown, as a lure to new investment. The mayor has also aggressively pushed industrial development projects throughout the city and neighborhood projects that stress exterior over interior improvements. A JCRA 50-percent matching grant for upgrading heating systems in small multifamily buildings was dropped in favor of grants for facade beautification or what one local rehab official calls "the Catherine-the-Great approach to rehab."

The prospects for large-scale retrofit in Jersey City are extremely poor, mostly because of lack of resources and lack of confidence in the future of the city. Rather than improve their properties, building owners and businesses are moving elsewhere. Cities that rely on oil heat have experienced the shock of rapidly rising energy prices sooner than other communities but the deregulation of natural gas may make Jersey City's story merely a forewarning of what will happen in other places.

## San Antonio

In San Antonio, the city and its energy future are closely entwined. The City Public Service (CPS) Board, a municipally owned utility, provides electricity and gas for San Antonio. A third of San Antonio's municipal budget comes from the utility and this revenue has helped pay for city services and keep the tax rate low. CPS has also provided the energy that has fueled the growth of a city that prizes economic development and wants more of it.

Typical residential electric and gas bills average around \$57 a month; summer cooling bills for the very hot San Antonio season are somewhat higher. These rates are not excessively high, nor has the city experienced the staggering rate increases all at once that have occurred in other communities.

For the most part in San Antonio, the concern is not so much with the cost of energy as with its supply. When concerns are raised against price, the villain is not the utility but the railroad companies which have increased coal hauling rates markedly in recent years. The railroads have become a favorite public whipping target of local officials.

CPS's dependence on coal is largely an outgrowth of the curtailment of natural gas sup-

plies on which it had relied up to about 1973. The Coastal States Gas Corp. and its subsidiary LoVaca Gathering Co. defaulted on gas supply contracts and left CPS and San Antonio in a brief but frightening energy supply cutoff. CPS moved quickly to diversify its energy sources and moved heavily into coal. At the time hauling rates were low, but they have more than tripled. These events of the past have had far-reaching ramifications beyond the high price of moving coal. For one thing, there is a lingering fear among many San Antonio business people that the city will be caught up short again by an energy cutoff, even though there is no rational basis for this fear. There is also the feeling that the utility has been burned twice, first by gas, now by coal, and that means a need to further diversify power sources. In response to this need, CPS has become a major partner in the South Texas Nuclear Project, an action that has engendered considerable controversy by environmentalist, consumer groups, and neighborhood organizations.

CPS has promoted an audit program but response in San Antonio has been extremely poor. The business community has not been particularly interested in energy issues. San Antonio has a major center for solar research at Trinity University, but advanced energy technology such as solar or heat transfer systems are

### Box 7—San Antonio

San Antonio is the largest city in Texas and it combines many of the attributes of a high-growth community with those of a Northern industrial town. The city's growth and economic development is a major civic issue in San Antonio. One of the problems of a rapidly expanding low-income minority population exacerbated by inflation and recession. San Antonio has a low unemployment rate—5.6 percent—but many of its citizens are relegated to low-paying jobs with not much of a future. The city's economy is dominated by tourism and the few military bases in the area. There is considerable new growth in downtown San Antonio, particularly in the vicinity of the *Paseo del Rio*, built during the New Deal but reinforced into a prime tourist attraction by more recent developers. However, in contrast to the fancy hotels, there is another side of San Antonio—77 percent of its housing stock is substandard and much of it is in just poor condition. City housing officials feel it is most cost-effective to tear the units down and rebuild new ones, rather than repair the old ones.

In 1977, San Antonio shifted from an at-large council to a council of 10 members (plus the mayor), elected from district districts in the city. This shift has had a profound effect on how the city is run and community groups are very powerful in the city. San Antonio has had a string of activist mayors that have exerted strong leadership in helping the city balance the needs of a local business community interested in growth and the serious problems of its low-income citizenry.



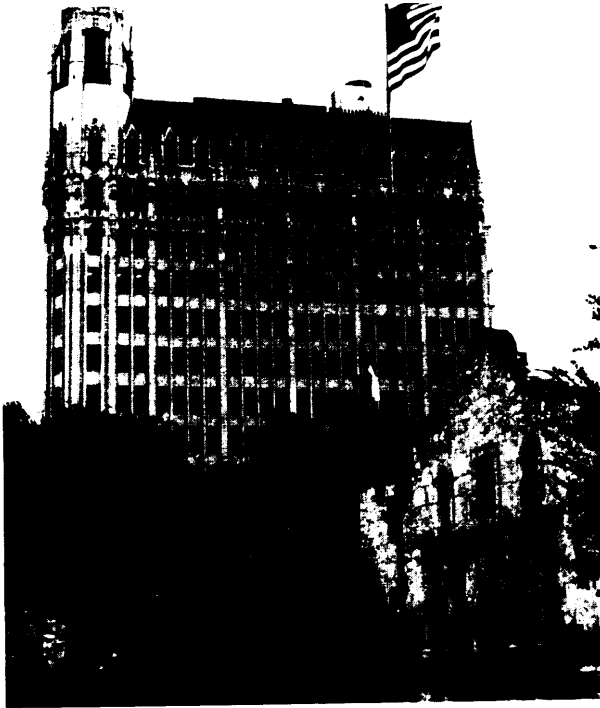

also only meagerly represented in the community.

The major interest in energy conservation per se has come from city government. Like several of the other case study cities, San Antonio's managers are concerned about the increasing share of the city's budget taken up by energy, but their focus is on energy use in city vehicles not in city buildings. The city has cut its fleet sharply and is converting much of it from gasoline to propane. City departments have strict fuel budgets and merit increases for department heads are tied to the extent to which fuel budgets are met. Several municipal buildings have been retrofitted and more such activity is programmed. The city has also tried to set an example for the community at large. The employer-based ride-sharing program is one of the best in the country and has involved Kelly Air Force Base and several other major local employers. Recently, San Antonio received funding from the Department of Energy for a demonstration



Photo credits Office of Technology Assessment

After a period of stagnation new construction has started again in San Antonio's downtown surrounding such tourist attractions as the Alamo. San Antonio's housing stock is largely of wood; much is in poor condition

project to encourage energy conservation in small businesses. The city has also interjected energy conservation issues in the planning process and has set up an Energy Conscious Development Committee to examine regulations to see which inhibit and which encourage energy savings.

San Antonio has a very large low-income population and **27 percent of the housing** in the city is substandard, according to local rehab officials. Some, in fact, are so dilapidated that the city has started a replacement housing program in which the substandard units are demolished and new homes built in their place. The San Antonio Redevelopment Agency (SARDA), a quasi-independent agency, runs the housing programs for the city and does include energy conservation as part of rehab activities. But it is minor compared to the overall rehab work necessary for San Antonio's poor housing stock. Nevertheless, SARDA loans and grants are virtually the only weatherization activity in the city. The Federal weatherization program does not operate in San Antonio because of a dispute between the State and city over the administration of the program. While some community groups have aggressively urged greater attention to energy conservation, their protests have been directed primarily at the South Texas Nuclear Project. The argument is that the money spent on this powerplant could better be put to weatherizing low-income homes. City CDBG funds, which have been used for energy and rehab in other cities, are not spent in this way in San Antonio and most community residents are not urging a redirection of CDBG moneys to energy.

At present, most San Antonians are more concerned about other things in their community, such as better jobs or adequate water supply, than energy. The push for conservation is weak and uncoordinated, with the exception of the city's own program to make government more energy efficient. But their example has not spilled over to the rest of the community and until it does the prospects for large-scale retrofit in San Antonio will remain small.

## Summing Up

These five cities show the great diversity of energy conservation activity across the Nation. The locus of energy conservation activity in each city varies and the cast of energy leaders changes. For example, in Tampa the utility is a spur for conservation, while in Jersey City and San Antonio, the utility as an active conservation force is quite weak. In Tampa and Des Moines, the business community has played a prominent role; in the other communities, the business community has been a weak force. In Buffalo, neighborhood groups and private energy designers have been active in promoting conservation, often in concert with the city and the utility. This has not happened to a great degree in the other cities. And while housing preservation and economic development are important in all five cities, the way these issues are framed and addressed varies substantially. In Tampa, for example, intensive but low-volume rehabilitation is the prime focus of housing activities. In Buffalo and Jersey City, facade improvements are important. In San Antonio, demolition and rebuilding are key components.

There are also some important similarities among these cities, from the point of view of energy. All five have been affected by energy price increases in recent years, although the level and impact of rate increases does vary. **All** five cities have audit programs run by the utility or oil dealers. In all five, local government has taken steps to reduce its own consumption of transportation and building energy. All of the governments have emphasized operating changes rather than capital investments to reduce energy use in municipally owned buildings. **The** use of CDBG and other public funds to address the retrofit needs of low- and moderate-income citizens has been minimal but is growing. The impact of weatherization has been extremely small. Above all, while energy prices are of some concern in these cities, energy has not been a major political issue. In fact, it has been rather far down on the civic agenda for both government and the public.

The experiences of these cities also corroborate several of the major findings of this study. They include:

- City government has not made energy conservation a high priority item except in its own operations.
- A major source of local funding, **CDBGs**, is only minimally used for retrofit and most of this activity is indirect, through rehab activities.
- Utilities had audit programs before the Federal regulations and are likely to continue them even if Federal regulations are withdrawn. Only a few of the utilities in the case study cities expect a significant impact on demand such that energy conservation could help to avoid capital expenditure for new generating capacity.
- Energy conservation programs and rehab programs by and large do not deal with multifamily buildings.
- There is very little interest in solar energy in the case study cities, largely because building owners doubt that it will pay off.
- The weatherization programs have been hampered in dealing with the low-income housing stock of these cities by restrictions on handling auxiliary repairs. The weatherization programs has by and large not been coordinated with the housing rehabilitation program.
- An activist State government can subtly influence conservation in local areas. The

most dramatic example of this among the case study cities was Tampa where both the State requirements for utility conservation programs and a State building code have spurred conservation activity.

Above all what comes through in these case studies is that all the programs in the world will not make a difference in increasing the rate of retrofit if people are not concerned enough about energy to take the first step. Most of these case study cities have at least one major retrofit program. Yet all report a generally low level of interest by both homeowners and the business community. The one group that is heavily burdened by energy price increases—the poor—have the interest but lack the resources. And even in the case of low-income households, other problems, such as overall housing conditions, may far outweigh their interest in energy.

In all of these cities the pace of retrofit is slow. The prospects for large-scale retrofit are not particularly promising in the short run. Only time can tell whether the pace of retrofit is also steady and whether, like the tortoise, the retrofit race will be won over a decade or more by slow and steady improvement in the energy efficiency of the building stock. It is possible to take a long perspective when dealing with the building stock of these cities much of which has been around at least a half century.

## CHAPTER 10 APPENDIX: INFORMATION ON THE HOUSING CHARACTERISTICS, HEATING AND COOLING EQUIPMENT, AND RESIDENTIAL FUEL USE OF THE CASE STUDY CITIES

**Appendix Table 1.—Housing Characteristics: Case Study Cities**

|                                      | Tampa   | Buffalo | San Antonio | Jersey City | Des Moines |
|--------------------------------------|---------|---------|-------------|-------------|------------|
| Housing characteristics              |         |         |             |             |            |
| Total housing units . . . . .        | 100,857 | 166,142 | 203,226     | 91,997      | 72,349     |
| Occupied housing units . . . . .     | 94,889  | 157,951 | 190,692     | 87,853      | 68,506     |
| Owner-occupied . . . . .             | 63,921  | 69,453  | 118,922     | 24,697      | 45,408     |
| percent . . . . .                    | 67.4    | 44.0    | 62.4        | 28.1        | 66.3       |
| Renter-occupied . . . . .            | 30,968  | 88,498  | 71,770      | 63,156      | 23,098     |
| Units in structure                   |         |         |             |             |            |
| All year-round units . . . . .       | 128,217 | 166,106 | 203,237     | 91,925      | 72,332     |
| 1, detached . . . . .                | 94,585  | 43,530  | 152,048     | 6,162       | 50,723     |
| 1, attached . . . . .                | 2,606   | 1,561   | 4,274       | 4,395       | 141        |
| 2 . . . . .                          | 6,174   | 76,937  | 11,202      | 24,409      | 4,783      |
| 3 and 4 . . . . .                    | 4,864   | 21,919  | 8,663       | 12,901      | 3,854      |
| 5 or more . . . . .                  | 15,014  | 22,147  | 24,512      | 44,040      | 12,017     |
| Mobile home or trailer . . . . .     | 4,974   | 12      | 2,538       | 18          | 814        |
| Owner occupied . . . . .             | 84,930  | 69,472  | 118,871     | 24,259      | 45,359     |
| 1, detached . . . . .                | 77,956  | 35,876  | 112,496     | 5,085       | 42,532     |
| 1, attached . . . . .                | 254     | 231     | 657         | 3,654       | 48         |
| 2 . . . . .                          | 1,470   | 28,991  | 2,509       | 11,065      | 1,299      |
| 3 and 4 . . . . .                    | 516     | 3,539   | 672         | 2,476       | 411        |
| 5 or more . . . . .                  | 587     | 823     | 592         | 1,979       | 339        |
| Mobile home or trailer . . . . .     | 4,147   | 13      | 1,945       | 18          | 730        |
| Renter occupied . . . . .            | 35,927  | 88,481  | 71,853      | 63,583      | 23,136     |
| 1, detached . . . . .                | 12,812  | 6,857   | 33,176      | 940         | 6,593      |
| 1, attached . . . . .                | 2,256   | 1,277   | 3,356       | 654         | 87         |
| 2 . . . . .                          | 4,039   | 44,578  | 7,640       | 12,722      | 3,222      |
| 3 and 4 . . . . .                    | 3,669   | 16,444  | 7,038       | 9,679       | 3,070      |
| 5 to 9 . . . . .                     | 4,099   | 7,949   | 5,173       | 15,081      | 3,796      |
| 10 to 19 . . . . .                   | 3,974   | 4,123   | 3,233       | 9,586       | 2,810      |
| 20 to 49 . . . . .                   | 1,906   | 2,525   | 3,542       | 8,631       | 1,843      |
| 50 or more . . . . .                 | 2,345   | 4,728   | 8,102       | 6,272       | 1,631      |
| Mobile home or trailer . . . . .     | 827     | —       | 593         | 18          | 84         |
| Year-round vacant for rent . . . . . | 3,890   | 4,685   | 7,708       | 2,765       | 2,244      |
| 1 . . . . .                          | 1,101   | 294     | 2,635       | 76          | 391        |
| 2 to 4 . . . . .                     | 1,014   | 2,866   | 1,565       | 901         | 459        |
| 5 to 9 . . . . .                     | 594     | 422     | 849         | 713         | 554        |
| 10 or more . . . . .                 | 1,181   | 1,103   | 2,659       | 1,075       | 840        |
| Year structure built                 |         |         |             |             |            |
| All year-round units . . . . .       | 128,217 | 166,106 | 203,237     | 91,925      | 72,332     |
| 1969 to March 1970 . . . . .         | 6,053   | 166     | 6,483       | 450         | 2,183      |
| 1965 to 1968 . . . . .               | 14,280  | 884     | 20,598      | 2,853       | 3,921      |
| 1960 to 1964 . . . . .               | 19,600  | 1,894   | 22,332      | 3,648       | 5,151      |
| 1950 to 1959 . . . . .               | 38,993  | 9,378   | 60,011      | 4,695       | 13,526     |
| 1940 to 1949 . . . . .               | 19,511  | 11,391  | 41,387      | 7,734       | 8,217      |
| 1939 or earlier . . . . .            | 29,780  | 142,393 | 52,426      | 72,545      | 39,334     |
| Owner-occupied . . . . .             | 84,930  | 69,472  | 118,871     | 24,259      | 45,359     |
| 1969 to March 1970 . . . . .         | 2,654   | 39      | 2,744       | 63          | 569        |
| 1965 to 1968 . . . . .               | 8,503   | 196     | 10,457      | 664         | 1,944      |
| 1960 to 1964 . . . . .               | 15,543  | 596     | 14,335      | 1,374       | 3,810      |
| 1950 to 1959 . . . . .               | 30,753  | 4,379   | 41,140      | 1,116       | 10,861     |
| 1940 to 1949 . . . . .               | 11,178  | 3,486   | 23,025      | 1,120       | 6,253      |
| 1939 or earlier . . . . .            | 16,299  | 60,776  | 27,170      | 19,922      | 21,922     |
| Renter-occupied . . . . .            | 35,927  | 88,481  | 71,853      | 63,583      | 23,136     |
| 1965 or March 1970 . . . . .         | 7,641   | 778     | 11,557      | 2,308       | 2,828      |
| 1960 to 1964 . . . . .               | 3,440   | 1,178   | 7,004       | 2,221       | 1,182      |
| 1950 to 1959 . . . . .               | 6,696   | 4,827   | 16,283      | 3,438       | 2,301      |
| 1940 to 1949 . . . . .               | 7,251   | 7,594   | 15,857      | 6,030       | 1,713      |
| 1939 or earlier . . . . .            | 10,899  | 74,104  | 21,152      | 49,586      | 15,112     |

Appendix Table 1.—Housing Characteristics: Case Study Cities—continued

|   | Tampa         | Buffalo | San Antonio | Jersey City | Des Moines   |
|---|---------------|---------|-------------|-------------|--------------|
| Structural characteristics                        |               |         |             |             |              |
| <b>Plumbing facilities</b>                        |               |         |             |             |              |
| With all plumbing facilities . . . . .            | 95,912        | 160,428 | 190,831     | 86,401      | 69,018       |
| Lacking some or all plumbing facilities . . . . . | <b>4,868</b>  | 5,679   | 12,328      | 5,555       | 3,319        |
| Lacking only hot water . . . . .                  | <b>2,988</b>  | 624     | 5,358       | 2,741       | 144          |
| Lacking other plumbing facilities . . . . .       | 1,880         | 5,055   | 6,970       | 2,814       | 3,175        |
| <b>Piped water in structure</b>                   |               |         |             |             |              |
| Hot and cold . . . . .                            | <b>97,439</b> | 165,204 | 194,238     | 88,686      | 71,726       |
| Cold only . . . . .                               | <b>3,294</b>  | 864     | 8,259       | 3,240       | 483          |
| None . . . . .                                    | <b>47</b>     | 39      | 662         | 30          | 128          |
| <b>Flush toilet</b>                               |               |         |             |             |              |
| For exclusive use of household . . . . .          | <b>99,428</b> | 162,589 | 199,542     | 90,397      | 69,820       |
| Also used by another household . . . . .          | 1,091         | 3,334   | 1,972       | 1,398       | 1,953        |
| None . . . . .                                    | 261           | 184     | 1,645       | 161         | 564          |
| <b>Bathtub or shower</b>                          |               |         |             |             |              |
| For exclusive use of household . . . . .          | 99,047        | 161,303 | 196,604     | 89,416      | 69,309       |
| Also used by another household . . . . .          | 1,108         | 3,370   | 2,008       | 1,171       | 2,064        |
| None . . . . .                                    | 625           | 1,434   | 4,547       | 1,369       | 964          |
| <b>Complete kitchen facilities</b>                |               |         |             |             |              |
| All year-round units . . . . .                    | 100,780       | 166,107 | 203,159     | 91,956      | 72,337       |
| For exclusive use of household . . . . .          | 98,926        | 160,223 | 197,310     | 90,101      | 70,799       |
| Also used by another household . . . . .          | 272           | 676     | 324         | 384         | <b>100</b>   |
| No complete kitchen facilities . . . . .          | 1,582         | 5,208   | 5,525       | 1,471       | <b>1,438</b> |
| Renter occupied . . . . .                         | 30,968        | 88,498  | 71,770      | 63,156      | 23,098       |
| For exclusive use of household . . . . .          | 29,908        | 84,905  | 69,123      | 61,740      | 22,168       |
| Also used by another household . . . . .          | 198           | 486     | 201         | 305         | 73           |
| No complete kitchen facilities . . . . .          | 862           | 3,107   | 2,446       | 1,111       | 857          |
| <b>Access</b>                                     |               |         |             |             |              |
| With direct access . . . . .                      | 100,727       | 165,816 | 203,014     | 91,674      | 72,252       |
| Locking direct access . . . . .                   | 53            | 291     | 145         | 282         | 85           |

SOURCE 1970 Census, *Detailed Housing Characteristics*

**Appendix Table 2.—Residential Heating and Cooling Equipment: Case Study Cities**

|   | Tampa   | Buffalo | San Antonio | Jersey City | Des Moines |
|---|---------|---------|-------------|-------------|------------|
| <i>Air conditioning</i>                           |         |         |             |             |            |
| All year-round units . . . . .                    | 128,188 | 166,101 | 203,268     | 91,911      | 72,341     |
| Room unit   |         |         |             |             |            |
| 1 . . . . .                                       | 33,383  | 11,018  | 44,587      | 21,128      | 21,671     |
| 2 or more . . . . .                               | 13,878  | 2,642   | 35,215      | 9,165       | 4,093      |
| Central system . . . . .                          | 22,693  | 1,574   | 41,522      | 2,247       | 10,692     |
| None . . . . .                                    | 58,234  | 150,867 | 81,944      | 59,371      | 35,885     |
| <i>Heating equipment</i>                          |         |         |             |             |            |
| All year-round units . . . . .                    | 128,217 | 166,106 | 203,237     | 91,925      | 72,332     |
| Steam or hot water . . . . .                      | 909     | 41,896  | 3,078       | 66,965      | 9,467      |
| Warm-air furnace . . . . .                        | 25,599  | 78,820  | 55,065      | 8,301       | 59,520     |
| Built-in electric units . . . . .                 | 13,780  | 983     | 6,030       | 1,063       | 228        |
| Floor, wall, or pipeless furnace . . . . .        | 21,438  | 5,690   | 32,392      | 723         | 1,372      |
| Room heaters with flue . . . . .                  | 43,212  | 31,086  | 36,654      | 9,304       | 1,349      |
| Room heaters without flue . . . . .               | 14,066  | 3,800   | 41,119      | 1,981       | 239        |
| Fireplaces, stoves, or portable heaters . . . . . | 7,867   | 3,498   | 27,546      | 3,140       | 144        |
| None . . . . .                                    | 1,346   | 333     | 1,353       | 448         | 13         |
| Owner occupied . . . . .                          | 84,930  | 69,472  | 118,871     | 24,259      | 45,359     |
| Steam or hot water . . . . .                      | 422     | 14,472  | 1,170       | 17,830      | 1,606      |
| Warm-air furnace . . . . .                        | 18,534  | 42,432  | 34,263      | 3,667       | 41,826     |
| Built-in electric units . . . . .                 | 6,946   | 250     | 2,703       | 240         | 93         |
| Floor, wall, or pipeless furnace . . . . .        | 18,632  | 2,746   | 23,774      | 260         | 846        |
| Room heaters with flue . . . . .                  | 28,782  | 8,015   | 19,381      | 1,526       | 795        |
| Room heaters without flue . . . . .               | 7,339   | 732     | 23,079      | 266         | 105        |
| Fireplaces, stoves, or portable heaters . . . . . | 4,012   | 780     | 14,102      | 425         | 83         |
| None . . . . .                                    | 263     | 45      | 399         | 45          | 5          |
| Renter occupied . . . . .                         | 35,927  | 88,481  | 71,853      | 63,583      | 23,136     |
| Steam or hot water . . . . .                      | 431     | 25,008  | 1,718       | 46,352      | 6,902      |
| Warm-air furnace . . . . .                        | 5,684   | 33,815  | 17,526      | 4,204       | 15,036     |
| Built-in electric units . . . . .                 | 5,953   | 698     | 2,933       | 795         | 127        |
| Floor, wall, or pipeless furnace . . . . .        | 2,037   | 2,763   | 7,393       | 449         | 477        |
| Room heaters with flue . . . . .                  | 11,965  | 20,846  | 15,063      | 7,364       | 425        |
| Room heaters without flue . . . . .               | 5,784   | 2,714   | 15,263      | 1,569       | 121        |
| Fireplaces, stoves, or portable heaters . . . . . | 3,225   | 2,516   | 11,407      | 2,540       | 48         |
| None . . . . .                                    | 848     | 121     | 550         | 310         | —          |

SOURCE 1970 Census, *Detailed Housing Characteristics*.

Appendix Table 3.—Residential Fuel Use: Case Study Cities

|                                     | Tampa   | Buffalo | San Antonio | Jersey City | Des Moines |
|-------------------------------------|---------|---------|-------------|-------------|------------|
| All occupied housing units. . . . . | 120,686 | 157,958 | 190,727     | 87,802      | 68,384     |
| <b>House heating fuel</b>           |         |         |             |             |            |
| Utility gas . . . . .               | 10,282  | 142,806 | 172,981     | 37,747      | 64,153     |
| Fuel oil, kerosene, etc. . . . .    | 70,378  | 10,423  | 975         | 45,650      | 1,986      |
| Coal or coke . . . . .              | —       | 1,242   | —           | 1,094       | 372        |
| Wood . . . . .                      | 354     | 22      | 240         | 122         | —          |
| Electricity . . . . .               | 28,590  | 1,121   | 10,863      | 1,159       | 842        |
| Bottled, tank, or LP gas. . . . .   | 9,485   | 1,312   | 4,515       | 964         | 662        |
| Other fuel . . . . .                | 263     | 883     | 312         | 795         | 369        |
| None . . . . .                      | 1,334   | 149     | 841         | 271         | —          |
| <b>Water heating fuel</b>           |         |         |             |             |            |
| Utility gas . . . . .               | 9,437   | 149,621 | 170,802     | 44,564      | 64,381     |
| Fuel oil, kerosene, etc. . . . .    | 1,655   | 2,009   | 213         | 36,876      | 115        |
| Coal or coke . . . . .              | 41      | 624     | —           | 689         | —          |
| Wood . . . . .                      | —       | 37      | 22          | —           | —          |
| Electricity . . . . .               | 100,164 | 2,529   | 7,129       | 953         | 2,524      |
| Bottled, tank, or LP gas . . . . .  | 5,106   | 2,164   | 4,475       | 1,266       | 841        |
| Other fuel . . . . .                | 486     | 554     | 156         | 766         | —          |
| None . . . . .                      | 3,797   | 420     | 7,930       | 2,688       | 523        |
| <b>Cooking fuel</b>                 |         |         |             |             |            |
| Utility gas . . . . .               | 14,640  | 132,093 | 155,557     | 83,311      | 49,023     |
| Electricity . . . . .               | 90,993  | 23,510  | 29,393      | 1,937       | 17,365     |
| Bottled, tank, or LP gas. . . . .   | 13,261  | 969     | 4,212       | 1,248       | 1,446      |
| Fuel oil, kerosene, etc. . . . .    | 1,117   | 127     | 380         | 780         | 58         |
| Coal or coke . . . . .              | —       | 66      | —           | 101         | 38         |
| Wood . . . . .                      | 66      | 22      | 182         | —           | —          |
| Other fuel . . . . .                | 99      | 125     | 349         | 168         | —          |
| None . . . . .                      | 510     | 1,046   | 654         | 257         | 454        |

SOURCE 1970 Census, *Detailed Housing Characteristics*

**Chapter 11**  
**Public Policy Options**



# Contents

|   |                    |
|---|--------------------|
| Option A—No Direct Intervention. . . . .  | <i>Page</i><br>299 |
| Option B—Small Federal Market   |                    |
| Assistance Role. . . . .  | 300                |
| Information . . . . .   | 301                |
| Small-Scale Subsidy Program. . . . .  | 302                |
| Federal Support for Low-cost,<br>Locally Defined Programs. . . . .                              | 302                |
| Option C—Large Active Federal Role. . . . .   | 303                |
| Interest Subsidies. . . . .   | 303                |
| Direct Subsidy Payments. . . . .  | 303                |
| Massive Subsidy or Regulation. . . . .  | 304                |
| Increased Support for Local Initiatives. . . . .  | 304                |
| Local Government Options. . . . .   | 306                |
| Single-Family Frame, Detached<br>Homes—Moderate and Upper Income. . . . .                       | 306                |
| Masonry Single-Family and Small<br>Multifamily Structures—Moderate<br>and Upper Income. . . . . | 307                |
| Low-Income Owner-occupied Small<br>Houses. . . . .  | 307                |

|   |                    |
|---|--------------------|
| Low-Income Multifamily. . . . .                                   | <i>Page</i><br>307 |
| Owner-occupied Small Businesses. . . . .                          | 307                |
| Tenant-Occupied Small Businesses. . . . .                         | 307                |
| Large Tenant-Metered Multifamily. . . . .                         | 308                |
| Large Master-Metered Multifamily. . . . .                         | 308                |
| Large Businesses—Especially Owner-<br>Occupied Buildings. . . . . | 308                |
| Public Buildings. . . . .   | 308                |
| State Policy Options. . . . .                                     | 308                |

## LIST OF TABLES

|   |             |
|---|-------------|
| Table No.   | <i>Page</i> |
| 89. Two Forms of Federal Subsidy. . . . .   | 305         |
| 90. Building Stock of Main Street, U.S.A.<br>A Hypothetical City of 400,000<br>population . . . . . | 306         |

This chapter summarizes various approaches that might be adopted as public policy to stimulate the retrofit of city buildings for greater energy efficiency. Most of the chapter deals with Federal level actions and choices. A discussion of what a hypothetical American city might consider initiating on its own is included, as well as a statement on the principal options open to States.

The Federal options are arrayed in a familiar manner; no direct intervention, moderate intervention, and substantial intervention. In practice, policy makers will select various combinations of the activities described here, or others, according to their belief in the effectiveness of the program and the importance of building retrofits in general. The options highlighted in the chapter reflect the findings of the study concerning the uncertainty of savings and the cost of financing as the principal factors affecting building owners' choices about retrofit investment. Cost calculations done by OTA for some new initiatives are included in the text. Information on funding and details of existing programs will be found elsewhere in the report, particularly chapter 9.

The three policy categories reflect several real and distinct schools of thought now active in the energy conservation debate. After a period of activist governmental approaches to the problem, Congress has been presented with a greatly reduced budget recommendation, reflecting more emphasis on the overall economy than on energy. Another point of view that has developed over the past few years advocates increased local choice in energy issues, with the Federal Government playing a supportive or catalytic role only. All these perspectives can be found in this chapter.

As in other debates about the impact of Federal Government intervention on the American economy and society, there is insufficient data to conclusively support one point of view to the exclusion of others. There are fragments of information that can be used to support all these points of view but the difference among them ultimately comes down to a difference of belief—in the seriousness of the U.S. energy problem, in the benefits of increased energy efficiency, and in the benefits, or dangers, of Government intervention.

## **OPTION A—NO DIRECT INTERVENTION**

The rationale for this definition of the Federal role is that energy retrofit is best left to the private sector. If the economy of the Nation is healthy, a wide variety of innovative technical and financial approaches will be developed to take advantage of the investment opportunities created by rising fuel prices. Efforts to reduce the uncertainty of retrofit results will be best undertaken by trade associations and other private groups with a stake in the results, not by the Federal machinery. States and localities, those units of government closest to the problem, would be free to act in their communities as they see fit. Issues of equity would be resolved through local responses and economic growth.

The underlying philosophy reflected here is that energy is a problem only because the national economy has not operated to provide accurate price signals and other characteristics of a free market. Government efforts must therefore be directed at allowing the market to operate correctly.

Accurate energy price signals would result from moving toward full marginal pricing for energy, through such steps as decontrol of natural gas and the removal of existing subsidies to fuels. Only those restrictions essential to the public health and well-being would be left intact; the lack of restrictions and standards would

allow for full competition and risk taking by entrepreneurs and investors. Investments in conservation would result from the decisions of consumers, choosing freely from supply and demand options.

Lowered interest rates and correspondingly reduced rates of debt service, provided by the healthy economy, would make those building owners dependent on debt financing far more likely to invest in energy retrofit than they are today. Greater capital availability, accelerated through such devices as the new tax depreciation schedules, would be preferred to targeted tax credits. Capital would thus be used to invest in the equipment of greatest value to the purchaser. The newly stabilized economy resulting from reduced rate of inflation and lowered interest rates would have the effect of lengthening the terms of available loans, thus lowering debt service and easing cash flow problems.

The competitive marketplace would give rise to voluntary development of standards by professional groups and tradespeople, and to disclosure of information. Rising prices would provide targets of opportunity in all areas of the buildings sector, as entrepreneurs find profitable areas of operation.

The traditional research and development (R&D) role of Government would remain, with Government funding only long-term, basic research in such areas as physics, engineering, and materials, with results made available to the

private sector for application. No demonstration or commercialization efforts would be considered.

Under this approach, the Government would not prefer one "solution" to the energy problem to another, but would act as a neutral body. The free economy, representing all consumers, would make investments based on market information, and the level of building retrofit would reflect its real economic value. Government actions to achieve this policy would include at least these points.

- Removal of price controls on natural gas, other price restraints on fuel costs, and Government support for any movement toward marginal cost pricing of energy, Removal of tax credits and other subsidies.
- Removal of unnecessary regulations that distort costs of energy supply or demand; reliance on the total economy to allocate costs of externalities.
- Efforts to stabilize the economy, lower inflation, and reduce interest rates. This would include balancing the budget, controlling the monetary supply, and whatever other steps were believed to lead to a steady, resilient marketplace.
- Continuation of governmentally funded research in basic areas, such as work on materials, heat flows, basic engineering, and other similar areas.

## OPTION B—SMALL FEDERAL MARKET ASSISTANCE ROLE

This option reflects the view that energy retrofit is too important to be left entirely to the private market, since it is possible that an adequate private market response will not develop. Nonetheless, the role of the Government should still be limited. The limitation reflects two constraints; a view that limited Federal financial resources must be used carefully, and a view that ultimate acceptance of the conservation option does rest with the market economy. The view might be expressed as a belief that the best mechanism to accomplish conservation is

the market, but that certain inevitable imperfections in the market will not disappear of their own accord, and that the market must be corrected. While price is still assumed to be the strongest driving force behind investment, some additional action by the Government is warranted.

Such a program would contain elements of information (including applied research), small-scale subsidies, and support for local decision-making.

## Information

**OTA** concluded from this study that a large impact would result from reducing the actual and perceived risk and uncertainty surrounding the results of energy retrofit. Such an approach might include three elements.

**Testing Individual Retrofits.** Much of the data now used by energy auditors and others in the field for determining the savings from particular retrofits have come from the National Laboratories (Oak Ridge, Brookhaven, Argonne, Lawrence Berkeley, etc.). Their careful, scientific research programs for testing specific improvements to boiler technology, certain passive solar retrofits, and so on, provide a basis of reliable, accurate data. New products are now entering the market at a rapid rate; testing and documentation of new products and techniques by the laboratories will speed the process and generate information for private companies and local agencies. This is an applied research effort of a type not likely to be undertaken with similar credibility by trade groups or individual firms.

**Comparison of Predicted and Actual Results From Packages of Retrofits.** This is a role of critical importance now performed only on a very small scale by the Federal Government, **in conjunction with a few trade associations.** As clearly indicated in chapters 3 and 4, there is a great lack of data on actual retrofits of buildings by type, especially multifamily buildings, shopping centers, and small retail and office buildings. There is even less data on the difference between actual and predicted savings from retrofits. Investors accordingly respond with caution.

An example of this type of analysis is *Saving School House Energy*, by Arthur Rosenfeld at Lawrence Berkeley Laboratory. This project compared predicted with actual savings from nine school building retrofits. Where savings fell below predictions there was a detailed analysis of the problems (selection, installation, Or maintenance of retrofits) causing the shortfall.

Such meticulous comparisons of actual installations with predicted results may be best developed through the groups that building owners rely on for information; trade associations, pro-

fessional societies, local civic associations and others. (Noninvestor owners may be more likely to be found in civic groups such as the chamber of commerce than in trade groups.) There are some existing Federal programs along this line. The American Hotel & Motel Association is retrofitting six different buildings in several climates, and will **observe and document the results.** The Federal schools and hospitals program has stimulated many building audits; most measures applicable to schools and hospitals are also useful to retail and office building retrofits. OTA research in case study cities found that school and hospital audits and retrofits had built the reputation of local companies, and created a belief that retrofit was real and practical **for a local area.**

**OTA** calculated the cost of an efficient and well-designed program to collect data on retrofits of **5,000** buildings of different types. This data would provide a very substantial improvement in the knowledge on retrofits. A budget of \$20 million assumes 150 person-years in design and data collection of retrofit packages, in collaboration with various trade and civic groups, such as those serving the restaurant community, multifamily dwellings, department stores and others. An additional \$5 million could be used to pay building owners or auditors about \$1,000 each for the trouble of maintaining accurate records of energy use before and after the retrofits, and making those records available.

**Dissemination of Results.** Additional efforts would be made to build on existing information distribution channels. This **would include more** work with appraisers, lenders, and other affiliated groups, and the development of regional and local data bases.

**Other Information.** Additional information programs would be consistent with this approach; these might be defined as applied R&D. For example, the Government might assist in the development of test procedures and support trade groups in the development of voluntary standards. Government assistance could be expected to produce acceptable, consensus-based standards more quickly than strictly private efforts.

Labeling programs could also be initiated by the Government in the voluntary context. Labels currently required on household major appliances have assisted consumers in making investment **choices** in a confusing area, and have been accepted as useful by a number of manufacturers. While new equipment purchased for commercial building **use will generally come with specifications adequate** for the trained engineers who will select and install them, products for homes require more common language. Labeling and standard measurement are measures that the Government can take to "correct" the market and increase the real competition.

### Small-Scale Subsidy Program

The programs described here are existing small-scale subsidy programs that fit logically within the overall view embodied in option B.

Two subsidy programs approved by Congress might be tapped for expansion of the data needed on retrofit. Individuals and organizations receiving assistance through the Schools and Hospitals Programs, or the Conservation Bank, described in chapter 9, might be asked to participate in the documentation effort. These data (especially from individuals using the Conservation Bank) would not be expected to be as accurate and detailed as the documentation carried out by Government research, but enough is known about data collection to design a program to tap this source of information.

Energy tax credits are another existing subsidy program that increases information about what retrofits are being installed. At present, the tax credit available to individuals operates to **provide some limited assistance, and results in expenses of about \$600 million annually** (twice the cost of the weatherization program). The tax credit system as it is currently constituted does provide information to the Government on the number and income level of people taking the credit, and the principal uses of the credit. The business energy tax credit is effectively restricted by implementing regulations in **such a**

way that few commercial buildings can be assisted (see ch. 9).

Low-income energy assistance (costing \$1.8 billion in 1981) might also be retained under this option, in order to try and meet the survival needs of low-income families, who are likely to be unable to cope with the cost pressures of a market-based energy approach (see ch. 5). The program might be tied to the weatherization program, which would also be continued. Families using income assistance might be referred to the weatherization program for coordination, or they might be allowed to use assistance money for weatherization work if they choose.

### Federal Support for Low-Cost, Locally Defined Programs

**Low-Cost/No-Cost Campaigns.** The prototypical low-cost/no-cost effort took place in Fitchburg, Mass., and is described in detail in chapter 5. This program has been tried elsewhere and could be replicated in many communities. The effort was designed locally, involved community groups from the beginning, and set out to inform citizens about practical, low-cost changes to save energy. It resulted in a large response in terms of interest and energy savings. Such programs can simultaneously achieve energy savings and build a base for subsequent, more extensive audit and retrofit programs. They cost little in Federal resources but do require a small, well-trained and enthusiastic Federal staff.

**Innovative Grants.** The innovative grants for energy conservation given by the Department of Housing and Urban Development seem to have played a role in the development of strategies for such energy-activist communities as Portland, Oreg., Minneapolis, Minn., and others. The grants enabled communities to define careful approaches, involving the private sector and leveraging private funds. The flexibility of the grants is appealing to communities, and provides them with some resources for **more innovative planning.**

## OPTION C—LARGE ACTIVE FEDERAL ROLE

This view is consistent with a philosophy which holds that if energy retrofit is an inexpensive use of energy capital, and if it is not likely to come about due to current conditions of the private market, the Federal Government should either subsidize or require all or most energy retrofit that is defined as cost effective. This point of view will generally emphasize the environmental and social costs of lagging behind on conservation, the national security value of reduced vulnerability to supply disruption, and other externalities. A serious rationale could include the stimulus of jobs in the building sector.

A policy reflecting this view would also stress the efforts at reducing uncertainty about retrofit results, described under option B. It would be more aggressive, however, in the areas of interest subsidies, direct payments to achieve retrofits, and regulation. These steps would be taken to ensure that the conservation yields were achieved quickly.

### Interest Subsidies

The current high interest rates and short loan terms lead to a very high cost of debt service on loans for energy retrofit (see ch. 4 for an extended discussion). Thus, building owners dependent on debt financing, and unable to tolerate cash flow losses even for short periods, have seldom retrofitted their buildings, even for some very cost-effective measures. OTA calculated (see ch. 2) that about 4 Quads of annual energy savings **will** not occur in commercial and multifamily buildings because of owner unwillingness or inability to retrofit assuming that interest rates do not fall. Under option C, the Federal Government might set an ambitious goal of stimulating retrofits over 10 years that would save 2 Quads per year of primary energy at the end of that time. OTA estimates that this might be possible from a financing subsidy of \$600 million a year for 10 years, (A general figure used by OTA and consistent with other recent work in the area of conservation is that about \$20 billion of investment will be needed for each annual Quad of primary energy savings, or \$40 billion total investment over 10 years. A

subsidy of \$600 million for annual retrofit expenditures of about \$4 billion is a 15-percent subsidy.)

A financing subsidy of this magnitude could be used in a variety of ways to lower the financing costs of retrofit. Part **of it could** be used to lower interest rates (e.g., from 16 to 13 percent) and the rest to provide loan guarantees to persuade banks to lengthen loan terms. An extension of the current secondary market for property improvement loans to multifamily and commercial buildings should also have the effect of lengthening loan terms. As discussed in chapter 4, longer term loans at reasonable rates are sensible for energy retrofits because many effective retrofits will return savings over a long lifetime.

### Direct Subsidy Payments

A number of available programs could be strengthened, increased, and focused more directly on individuals, businesses, and institutions involved in retrofitting. While these programs represent only changes in existing efforts, they could be targeted more explicitly to stimulate retrofit on a large scale in specific types of buildings.

**Tax credits** for residential uses by individuals would be continued and possibly increased in amount. They could be made refundable, so that people with little or no tax liability could participate fully. The business energy tax credit would be retained and revised so that commercial and retail businesses **could take full advantage of this option. Information obtained from examining the data on tax credit claims could be used to fine tune the system, and identify groups or sectors with low participation.**

**Grants to States** for training and information programs, particularly auditor training, would be intensified. Assistance of this type is a traditional State role, and builds network communication as well as skills.

**Utility** and other delivery mechanism programs **would be strengthened, with emphasis on identifying targets for greatest potential**

energy savings and “problem” sectors in local areas (such as multifamily buildings). The Residential Conservation Service (RCS) would be retained, perhaps with some modifications, as a method of requiring major utilities to provide home energy audits at minimal cost. Audit procedures and recommendations would be improved over time as knowledge expands. Audit and information programs for commercial and apartment buildings would also be supported, with flexibility built in to allow utilities to address those portions of their service population of most importance from the utility point of view (see ch. 8 for a discussion of utility interest), as well as providing information and assistance to other groups. Other delivery systems might receive support on a demonstration basis, to see if new, more effective mechanisms can be identified to facilitate retrofit. Information on these experiments would be widely shared.

### Massive Subsidy or Regulation

There appear to be two areas where a free market is unlikely to provide any direct incentives for a cost-effective rate of retrofit. Policy-makers sympathetic to the views of option C would be likely to attach significance to both categories.

**Low-Income Homeowners.** These families have little chance of retrofitting to any cost-effective level based on their own resources. The current weatherization program could be doubled in scope over a period of 2 to 3 years to a rate of about 720,000 dwelling units a year (up from a 1981 rate of 360,000 each year). Over 10 years this would reach half of the estimated 14 million low-income dwelling units, at a cost of about \$400 million a year (less than a quarter of the \$1.8 billion used in 1981 for low-income energy assistance). These expenditures could be assumed to work toward reducing the cost of any energy assistance payments over time.

**Tenant-Metered Multifamily and Commercial Buildings.** To date, there is little incentive for owners of these buildings to make major retrofits, since tenants bear the direct burden of utility costs. OTA found no evidence that com-

mercial or multifamily rentals are higher for energy-efficient buildings, although some owners interviewed believed that the market for office space might adjust to differences in energy efficiency sometime in the future. It is widely believed that multifamily tenants do not pay more for energy-efficient apartments than for energy-inefficient ones.

Given this situation, a policy of substantial Government intervention could take either of two approaches. One course would be to require any necessary improvements in building energy efficiency (if needed) prior to time of sale, while making subsidized financial assistance available to accomplish the task. Such a policy is difficult to implement given the American tradition of local control of real estate. It would have to be required of State governments, which in turn would have to require it of local governments. Another course of action would be to develop and implement a mandatory program of energy indexing of tenant-metered buildings.

### Increased Support for Local Initiatives

**Low-Cost/No-Cost . Campaigns could be used across the country to increase the involvement of citizens in retrofit and build community support for action.**

**Innovative Grants.** Energy conservation grants would be made available to many more cities to allow for the specific development of action plans for the locality.

**Conservation Bank.** Funding would be used to involve private lenders, subsidize interest rates, and develop local information and community networks.

**Community Development Block Grant (CDBG) Funds Earmarked for Retrofits.** Communities may now use their CDBG moneys for energy conservation, subject to certain overall restrictions on CDBG funding priorities. An increase in CDBG funds would provide more money to a property improvement and retrofit process that is already well-established at the local level, is subject to continuing public review and comments, and must generally re-

fleet local priorities over time. Special funds in this category could effectively be joined with housing rehabilitation funds for a big push to improve housing quality and cut costs of operating and maintenance. Localities could be specifically encouraged, or required, to extend their CDBG programs to apartment buildings.

**District heating might be favored for** Federal assistance under some versions of this philosophy. OTA calculates that subsidies could be provided to 10 citywide systems each costing \$1.5 billion. This would divert about 0.3 Quad of oil and gas from heating use and replace it with coal, cogenerated electricity and energy from solid waste combustion. If this subsidy were provided in the form of tax-free industrial bonds, about \$60 million per year per system in subsidized interest would total \$600 million each year, or about 4 percent of the total \$15 billion project cost for 10 systems. Taxes on this amount would not be paid to the Treasury, due to the tax-free nature of the bonds. Determining the actual cost to the Federal Government of this subsidy is complex, since a calculation would include impact on the taxable bond market, likelihood of investment in the bonds as opposed to taxable but potentially more profitable bonds, and the cumulative cost of interest subsidies on interest rates in the capital markets.

investments in district heating in the near future would lay the groundwork soon for an early 21st century economy based on coal and renewable. on the other hand, there are argu-

ments to be made for delaying a large-scale subsidy of district heating until the decontrol of natural gas prices makes district heat more competitively priced with the price of direct use of natural gas for heat. Some years delay would also give more time for energy efficiency retrofits to buildings which are potential district heating customers, so that their heating demand is minimized and stabilized. This assists the planning and sizing of district heating systems.

It is possible to compare the value of savings from a \$600 million a year financing subsidy to district heating with savings from a similar financing subsidy to building retrofit (see table 89). The value of 2 Quads of energy saved from building retrofits would be worth \$14 billion at the 1981 average price for home heating oil at about \$1 per gallon, or \$20 billion to \$30 billion at the current estimated price of synthetic oil from coal in 1981 dollars. (See the forthcoming OTA report, "Synthetic Fuels for Transportation," for further discussion.)

The value of savings from an equivalent subsidy to district heating is much less. If district heating primarily serves to shift demand from premium fuels, such as oil and gas to coal, the savings comes from the price difference between the two kinds of fuel. At \$4 per million Btu (about the current price differential between oil and coal for utilities), substituting **0.3 Quad** of heat from coal for heat from oil would be worth \$1.2 billion.

**Table 89.—Two Forms of Federal Subsidy**

| Subsidy type  | Cost per year | Energy impact  | Estimated value of savings (in dollars) |
|---|---------------|--|---|
| Subsidized \$40 billion in conventional loans over 10 years for energy retrofit                             | \$600 million | 2 Quads saved annually after 10 years  | \$14 billion to \$30 billion per year   |
| Ten district heating systems allowed to use tax-exempt financing (\$1.5 billion each), constructed 10 years | \$600 million | 0.3 Quad displaced annually from fuel oil or gas to coal, solid waste or waste heat (after 10 years) | \$1.2 billion per year                  |

SOURCE: Office of Technology Assessment



## LOCAL GOVERNMENT OPTIONS

As this report points out, the local government has the strongest concern and the most direct connection to the local building stock. This section discusses what options are open for a targeted strategy based on different, well-defined groups of city buildings. Proximity and small scale allow city governments to coordinate programs and policies in a way that the Federal Government cannot. Personal appeals and persuasion can be used by individuals and groups at the local level. This section is not meant to suggest that cities will act independent of Federal policy; they will presumably continue to take advantage of whatever Federal assistance they can tap. The policies here point out choices that remain regardless of outside help (but assuming some resource and some interest at the local level.)

It is important to keep in mind the numbers of city buildings of differing kinds. The smaller buildings are by far the most numerous. Table 90 shows the building stock for a hypothetical

**Table 90.—Building Stock of Main Street, U.S.A.  
A Hypothetical City of 400,000 Population<sup>a</sup>  
(total dwelling units, 150,000)**

| Category of building   | Number of buildings |
|--|---------------------|
| <b>Total residential buildings</b> . . . . .                                 | <b>82,300</b>       |
| <b>Single-family detached (wood frame)</b> . . . . .                         | <b>34,000</b>       |
| Single-family detached, low income (wood frame) . . . . .                    | 6,000               |
| Single-family attached (masonry) . . . . .                                   | 25,500              |
| Single-family attached, low income (masonry) . . . . .                       | 4,500               |
| Buildings with 2-4 units . . . . .   | 6,700               |
| Buildings with 2-4 units, low income (30,000 units) . . . . .                | 3,300               |
| Buildings with 5-19 units . . . . .  | 1,200               |
| Buildings with 5-19 units, low income . . . . .                              | 600                 |
| Buildings with more than 20 units . . . . .                                  | 340                 |
| Buildings with more than 20 units, low income . . . . .                      | 160                 |
| <b>Commercial buildings</b>  |                     |
| <b>Small commercial buildings, less than 5,000 ft.<sup>2</sup></b> . . . . . | <b>5,000</b>        |
| <b>Moderate, 5,000-50,000 ft.<sup>2</sup></b> . . . . .                      | <b>2,500</b>        |
| <b>Large, more than 50,000 ft.<sup>2</sup></b> . . . . .                     | <b>500</b>          |
| <b>Owner-occupied buildings</b>  |                     |
| <b>Half of all sizes of commercial buildings:</b>                            |                     |
| <b>Small</b> . . . . .   | <b>2,500</b>        |
| <b>Moderate</b> . . . . .  | <b>1,200</b>        |
| <b>Large</b> . . . . .   | <b>250</b>          |
| <b>One-third of multifamily with 2-4 units</b> . . . . .                     | <b>3,300</b>        |

<sup>a</sup>This table reflects the size distribution of housing units in central City areas in the United States, and an OTA calculation on the size distribution of commercial buildings in a central city area. No data is available on the actual distribution of commercial structures by central city location. Thus, the hypothetical city is typical of the mix of buildings that might be found across the country

but representative city of 400,000—Main Street, U.S.A. The only oddity about Main Street is that its housing stock is made half of wood and half of masonry (brick or cinder block) —this situation will be found only in certain regions of the Middle Atlantic and Southeast United States.

Cities are free to start on their own any of the programs described above as options for the Federal Government. (Many Federal programs actually reflect efforts initiated by cities some years ago.) Cities can work well with trade associations to improve retrofit documentation. They may establish their own interest subsidy or loan purchase plans, as Baltimore and St. Paul have done. They may subsidize district heating through local bonds, undertake a low-cost/no-cost effort, or initiate full-scale direct weatherization themselves. They can force competing city departments, responsive to different Federal funding sources, to work together more closely. They can involve a local utility, a local insurance company or pension fund, or the local lending community. Several different types of successful programs by particular cities are described in the case studies in chapter 10.

This section draws on the study findings of technical retrofit potential for different buildings and the motivation of various sets of building owners. Combinations of these programs might be effective for various buildings. Cities will select types of buildings, neighborhood, or other areas of emphasis for a variety of reasons.

### Single-Family Frame, Detached Homes —Moderate and Upper Income

There are about 34,000 of these in Main Street. Programs for this group will also apply to the approximately 3,000 owner-occupied multifamily buildings with two to four units (duplexes, walkup flats, etc.) Roof and wall insulation will be the most powerful retrofits for many of these buildings. Old frame buildings may also profit from “house doctor” diagnosis and correction of thermal leaks. The city could organize a focused high volume campaign to promote one or two widely applicable measures, per-

haps in conjunction with a local electric utility if electricity is the dominant heating source. The utility might provide long-term loans. A program would be designed to payback on retrofits in less than 5 years. The city could establish an energy information and financing center to minimize owner confusion, deal with complaints, and even schedule retrofits if activity is heavy. Neighborhoods, or the city itself, could lower costs by acting as a bulk purchaser. Neighborhood groups would be involved to spread the word through churches, schools, and other groups, and to seek out elderly owners and others often missed in general campaigns.

### **Masonry Single-Family and Small Multifamily Structures—Moderate and Upper Income**

While wall insulation will not represent a good payback for these structures, attic insulation may (depending on attic construction). Storm windows may also be important, depending on climate and saturation in the area. These buildings are good candidates for a high-volume, single measure campaign aimed at improving burner efficiency or replacing burners if needed. Local fuel oil dealers could be involved in this effort, along with the other groups mentioned in describing the frame building campaign.<sup>2</sup>

### **Low-Income Owner-Occupied Small Houses**

These buildings are prime candidates for a Fitchburg-type low-cost/no-cost effort to build confidence, perhaps followed up with low interest loans financed by city bonds. The loans might be used for more extensive retrofit. Loan terms should be arranged so that repayment is less than monthly fuel savings; i.e., total payments do not rise. Neighborhood groups can be used to bring the news and screen complaints.<sup>3</sup>

<sup>2</sup>Examples are the Pacific Gas & Electric attic insulation program (see ch. 7) and the Minneapolis block-by-block retrofit program (see ch. 10).

<sup>3</sup>The Philadelphia oil burner replacement program a good model (see ch. 5).

<sup>4</sup>In addition to the Fitchburg program (described in ch. 5), retrofit and rehabilitation programs in Boston and Pittsburgh (described in ch. 10) may be good models.

## **Low-Income Multifamily**

For this category of building, two programs would be useful: one to advise tenants on available assistance programs for intervention assistance payments if needed, and one to develop mechanisms for identifying buildings that may be moving toward abandonment due to rent pressures and rising energy costs. Special assistance funds can be considered for landlords facing this problem. Negotiating groups composed of tenants and neighborhood leaders are a possibility for attempting to resolve landlord conflicts. Further, all weatherization efforts and energy retrofit should be coordinated with other city retrofit programs, to ensure that when investments are made in a structure, energy receives due consideration. In federally funded public housing, it is important that modernization funds be used with full consideration of rising energy costs.<sup>4</sup>

### **Owner-Occupied Small Businesses**

If these are masonry or clad-wall buildings, retrofits should concentrate on lighting retrofits and adjustments to the HVAC system. The city could work with neighborhood business associations, perhaps targeting reviving neighborhoods which the community wants to keep afloat. The chamber of commerce might take on a project of obtaining information on lighting retrofits (fast-payback, so little or no financing should be required) and spreading the news. The city government could carefully review complaints on retrofits to protect the reputation of reputable contractors and identify problem retrofits early. As this group of owners becomes interested, encouragement to move toward larger retrofits would be helpful.

### **Tenant-Occupied Small Businesses**

Tenants sometimes pay their own lighting and electricity bills, so they might be interested in lighting retrofits as well, especially if they are on long-term leases. **Information provided on the importance of using energy only when operat-**

<sup>4</sup>New York City has programs to turn financially troubled buildings over to tenant management with technical assistance for dealing with energy conservation.

ing the building and other behavioral options would be important.

### **Large Tenant= Metered Multifamily**

These buildings are likely to have decentralized heating systems—gas heaters or electricity. Retrofits to upgrade unit efficiency are likely to be expensive, but will save considerable energy, paying back in 5 to 7 years. The city government could consider requiring upgrading of heating and hot water equipment (which may be centralized) over a period of 10 years. Financing for the retrofits might be arranged through a utility, the State housing finance agency, or a bond issue. Tenants could be assessed monthly surcharges (less than the likely savings in energy costs to tenants) to help finance investments.

### **Large Master-Metered Multifamily**

Hot water retrofits and retrofits to the central heating system should be of low (less than 2 years payback) and moderate (2 to 7 years payback) capital cost. The city government could help arrange long-term loans through lenders, perhaps with a shallow subsidy. This will be a small group of buildings; perhaps 100 out of 200 such large multifamily buildings in Main Street. Information on successful retrofits in other multifamily buildings, including control systems, should be of interest to this group of building owners, as they have a direct incentive to retrofit.

### **Large Businesses—Especially Owner-Occupied Buildings**

This will also be a small group of buildings—several hundred. Many of these owners will have their own financing and access to good professional advice. Civic groups and city leaders could persuade them to be innovators and demonstrators of successful retrofits, and share their experience. It is important to provide publicity and attention to this campaign and publicize dollar and energy savings as reflecting the civic commitment of these people.

### **Public Buildings (Including Schools)**

Bond money could be used for large retrofits, and expense money for small retrofits for these structures. The retrofits should be carefully documented and used to encourage businesses to invest. The diversity of city-owned buildings makes them a good laboratory. The city government could focus retrofits first on those building types that represent much of the city building stock for maximum utility of information, and advise citizens of savings through these retrofits.

Much of the material presented in chapter 10 describes what actual cities have done. It is clear that in all but a few cities, energy has been closely tied to other local priorities—economic development, equity, and so on. In general, energy campaigns will be successful if they are used to build on existing city strengths and priorities.

## **STATE POLICY OPTIONS**

While States have a major interest in energy conservation, they do not have a strong and direct connection with building energy use (see ch. 9). States can support cities and assist their citizens in several ways.

Through the public utility commission, they can provide incentives (requirements or rewards) for utility auditing and financing plans. The rewards can be tied to the types of conservation that best serve the utility as well as the

community, so that there is a mutual interest. In some States, load profiles and peaking characteristics will indicate a concentration on residential housing; in others, utilities will have a more natural interest in commercial structures. Florida and California represent models of this type of State action.

Housing finance agencies can play a crucial role in distributing funds for loan financing throughout the State, and State bonding author-

ity can also be used **for this purpose. In areas** where cities are financially strapped, funding support of this type may be the best possible assistance.

The energy codes for new building construction should be reviewed to make sure the State is keeping up with cost-effective opportunities. Energy efficiency in new buildings creates a competitive force that stimulates retrofit in existing buildings.

State resources can be used to provide training for tradespeople and documentation of retrofit results. Publications can be issued on “best choices” for the State, aimed at both the technical and the general community. Licensing requirements for energy trades should be reviewed in order to maintain high standards. Finally, agencies for reviewing consumer complaints can provide consumer protection as the number of retrofits increases.

# Appendixes

## Retrofit Options for Thirteen Building Types in the St. Louis Climate Zone

---

This is the first of four appendixes (A through D) which present backup information on building retrofit. This appendix has individual retrofit lists for each of 13 distinctly different building types. The analysis of retrofit costs and savings has been done for the St. Louis climate. The list for each building shows the estimated costs of each retrofit option for that building type. Savings are presented in two forms:

1. *Million Btu per year regardless of energy source.* In this estimate, Btu savings of electricity are counted equally with Btu savings of fuel.
2. *Million Btu per year, "fuel-adjusted."* In this estimate Btu savings of electricity are increased by multiplying by a factor of 2.46. The factor adjusts for the higher cost of electricity and is derived from the difference in cost per million Btus between fuel or \$1.00 per gallon (or \$7.14/MMBtu) and electricity at \$0.06/kWh (or \$17.58/MMBtu).

Finally the retrofit lists show the cost per million Btu saved of fuel-adjusted energy savings. The payback can be calculated from cost per million Btu by using

box B in chapter 3 as a guide. For fuel at \$1.00 per gallon, low capital cost retrofits which cost less than \$14.00 per annual million Btu saved, will payback in less than 2 years. Moderate capital cost retrofits will payback in 2 to 7 years and cost \$14 to \$49 per annual million Btu saved. In this appendix, as in chapter 3, low capital cost refers to low capital cost compared to savings. Some retrofits such as lighting retrofits can require substantial capital in an absolute sense even though they are low capital cost compared to savings.

High capital cost retrofits will payback in 7 to 15 years and will cost \$49 to \$105 per annual million Btu saved.

Users of this appendix should be aware that costs and savings presented here are estimates only. They are useful for order-of-magnitude comparisons among retrofit options but should not be relied on for subtle distinctions among retrofits. For any particular building estimated costs and savings could vary substantially from those presented here.

Table A1: Retrofit Options for a Small House with Frame Walls and Central Air Heating and Cooling

| <u>Retrofit Number</u> | <u>Name of Retrofit</u>      | <u>Total Cost Of Retrofit</u> | <u>Annual Savings in Million Btus (not fuel-adjusted)</u> | <u>Annual Savings in Million Btu<sup>≡</sup> (fuel-adjusted)</u> | <u>Total Retrofit Cost Per Annual Million Btu Saved (fuel adjusted)</u> |
|------------------------|------------------------------|-------------------------------|---|--|---|
|                        | <u>Low Capital Cost</u>      |                               |   |  |   |
| E-1                    | Roof Insulation              | 565                           | 32  | 39   | 14  |
| E-2                    | Wall Insulation              | 646                           | 83  | 107  | 6   |
| E-5                    | Weatherstripping             | 110                           | 7   | 8  | 14  |
| H-8                    | Setback Thermostats          | 135                           | 24  | 24   | 6   |
| H-2C                   | Two Speed Fan                | 110                           | 14  | 31   | 4   |
| D-2                    | Flow Controls                | 19                            | 14  | 14   | 1   |
| D-3                    | Insulate Hot Water Storage   | 30                            | 7   | 7  | 4   |
|                        | <u>Moderate Capital Cost</u> |                               |   |  |   |
| E-3                    | Storm Windows                | 990                           | 29  | 35   | 28  |
| H-3                    | Vent Damper                  | 225                           | 9   | 9  | 25  |
| H-18                   | Insulate Ducts               | 1230                          | 23  | 29   | 42  |
| D-4                    | Hot Water Vent Damper        | 150                           | 6   | 6  | 25  |
|                        | <u>High Capital Cost</u>     |                               |   |  |   |
| E-6                    | Window Insulation            | 9 °                           | 5   | 5  | 61  |

Table A2: Retrofit Options for a Small House With Frame Walls, Central Water Heating System and Window Air Conditioners

| <u>Retrofit Number</u> | <u>Name of Retrofit</u>       | <u>Total Cost Of Retrofit (not fuel-adjusted)</u> | <u>Annual Savings in Million Btus (fuel-adjusted)</u> | <u>Annual Savings in Million Btus (fuel-adjusted)</u> | <u>Total Retrofit Cost Per Annual Million Btu Saved (fuel adjusted)</u> |
|------------------------|-------------------------------|---|---|---|---|
|                        | <u>Low Capital Cost</u>       |   |   |   |   |
| E-1                    | Roof Insulation               | 565   | 33  | 42  | 13  |
| E-2                    | Wall Insulation               | 646   | 83  | 107   | 6   |
| E-5                    | Weatherstripping              | 110   | 7   | 9   | 12  |
| H-7                    | Modulating Aquastat           | 250   | 26  | 26  | 10  |
| H-8                    | Setback Thermostats           | 135   | 24  | 24  | 6   |
| D-2                    | Flow Controls                 | 19  | 14  | 14  | 1   |
| D-3                    | Insulate Hot Water Storage    | 30  | 7   | 7   | 4   |
|                        | <u>Moderate Capital Cost</u>  |   |   |   |   |
| E-3                    | Storm Windows                 | 990   | 31  | 39  | 25  |
| H-1                    | Replace Burner                | 880   | 19  | 19  | 46  |
| H-3                    | Vent Damper                   | 225   | 9   | 9   | 25  |
| H-4                    | Stack Heat Reclaimer          | 875   | 24  | 24  | 36  |
| H-1C                   | Replace Room Air Conditioners | 890   | 22  | 54  | 16  |
| D-4                    | Hot Water Vent Damper         | 150   | 6   | 6   | 25  |
|                        | <u>High Capital Cost</u>      |   |   |   |   |
| E-6                    | Window Insulation             | 90  | 5   | 5   | 61  |



Table A3: Retrofit Options for a Small House  
Frame Walls Decentralized System

| <u>Retrofit Number</u>       | <u>Name of Retrofit</u>       | <u>Total Cost Of Retrofit (not fuel-adjusted)</u> | <u>Annual Savings in Million Btus (fuel-adjusted)</u> | <u>Annual Savings in Million Btus (fuel-adjusted)</u> | <u>Total Retrofit Cost Per Annual Million Btu Saved (fuel adjusted)</u> |
|------------------------------|-------------------------------|---|---|---|---|
| <u>Low Capital Cost</u>      |                               |   |   |   |   |
| E-1                          | Roof Insulation               | 565   | 24  | 60  | 9   |
| E-2                          | Wall Insulation               | 646   | 88  | 216   | 3   |
| E-5                          | Weatherstripping              | 110   | 5   | 12  | 9   |
| D-2                          | Flow Controls                 | 19  | 14  | 34  | 0.5   |
| D-3                          | Insulate Hot Water Storage    | 30  | 8   | 20  | 1.5   |
| D-4                          | Hot Water Vent Damper         | 150   | 6   | 15  | 10  |
| <u>Moderate Capital Cost</u> |                               |   |   |   |   |
| E-3                          | Storm Windows                 | 99 <sup>o</sup>                                   | 22  | 54  | 18  |
| E-6                          | Window Insulation             | 91 <sup>o</sup>                                   | 90  | 20  | 46  |
| H-10                         | Replace Room Air Conditioners | 89 <sup>o</sup>                                   | 22  | 54  | 16  |
| D-5                          | Hot Water Heat Pump           | 98 <sup>o</sup>                                   | 19  | 47  | 21  |
| <u>High Capital Cost</u>     |                               |   |   |   |   |
| H-5                          | Install Heat Pumps            | 5520  | 39  | 96  | 58  |

Table A4: Retrofit Options for a Small Masonry Rowhouse with Central Air Heating and Cooling

| <u>Retrofit Number</u> | <u>Name of Retrofit</u>      | Total Cost Of Retrofit | Annual Savings in Million Btus (not fuel-adjusted) | Annual Savings in Million Btus (fuel-adjusted) | Total Retrofit Cost Per Annual Million Btu Saved (fuel adjusted) |
|------------------------|------------------------------|------------------------|--|--|--|
|                        | <u>Low Capital Cost</u>      |                        |  |  |  |
| E-1                    | Roof Insulation              | 690                    | 43   | 52   | 13   |
| E-5                    | Weatherstripping             | 60                     | 6  | 7  | 9  |
| H-8                    | Setback Thermostats          | 135                    | 15   | 15   | 5  |
| H-20                   | 2 Speed Fans                 | 80                     | 7  | 15   | 5  |
| D-2                    | Flow Controls                | 19                     | 14   | 14   | 1  |
| D-3                    | Insulate Hot Water Storage   | 30                     | 7  | 7  | 4  |
|                        | <u>Moderate Capital Cost</u> |                        |  |  |  |
| E-3                    | Storm Windows                | 450                    | 17   | 21   | 21   |
| H-3                    | Vent Damper                  | 225                    | 6  | 6  | 38   |
| D-4                    | Hot Water Vent Damper        | 150                    | 6  | 6  | 25   |
|                        | <u>High Capital Cost</u>     |                        |  |  |  |
| E-2                    | Wall Insulation              | 4664                   | 34   | 41   | 114  |
| E-6                    | Window Insulation            | 420                    | 8  | 8  | 53   |
| H-18                   | Insulate Ducts               | 810                    | 12   | 15   | 54   |

Table A5: Retrofit Options for a Small Masonry Rowhouse with Central Water Heating System and Window Air Conditioners

| <u>Retrofit Number</u>       | <u>Name of Retrofit</u>       | <u>Total Cost Of Retrofit</u> | <u>Annual Savings in Million Btus (not fuel-adjusted)</u> | <u>Annual Savings in Million Btus (fuel-adjusted)</u> | <u>Total Retrofit Cost Per Annual Million Btu Saved (fuel adjusted)</u> |
|------------------------------|-------------------------------|-------------------------------|---|---|---|
| <u>Low Capital Cost</u>      |                               |                               |   |   |   |
| E-5                          | Weatherstripping              | 60                            | 6   | 8   | 8   |
| H-8                          | Setback Thermostats           | 135                           | 15  | 15  | 9   |
| D-2                          | Flow Controls                 | 19                            | 14  | 14  | 1   |
| D-3                          | Insulate Hot Water Storage    | 30                            | 7   | 7   | 4   |
| <u>Moderate Capital Cost</u> |                               |                               |   |   |   |
| E-1                          | Roof Insulation               | 690                           | 37  | 47  | 15  |
| E-3                          | Storm Windows                 | 450                           | 17  | 22  | 20  |
| H-3                          | Vent Damper                   | 225                           | 6   | 6   | 38  |
| H-7                          | Modulating Aquastat           | 250                           | 13  | 13  | 19  |
| H-10                         | Replace Room Air Conditioners | 890                           | 13  | 32  | 28  |
| D-4                          | Hot Water Vent Damper         | 150                           | 6   | 6   | 25  |
| <u>High Capital Cost</u>     |                               |                               |   |   |   |
| E-2                          | Wall Insulation               | 4664                          | 42  | 53  | 88  |
| E-6                          | Window Insulation             | 420                           | 8   | 8   | 53  |
| H-4                          | Stack Heat Reclaimer          | 800                           | 16  | 16  | 50  |

Table A6: Retrofit Options for a Small Masonry Rowhouse with a Decentralized Heating and Cooling System

| Retrofit Number              | Name of Retrofit                | Total Cost Of Retrofit (not fuel-adjusted) | Annual Savings in Million Btus | Annual Savings in Million Btus (fuel-adjusted) | Total Retrofit Cost Per Annual Million Btu Saved (fuel adjusted) |
|------------------------------|---------------------------------|--|--------------------------------|--|--|
| E-1                          | Roof Insulation                 | 690  | 24                             | 59   | 12   |
| E-5                          | Weatherstripping                | 60   | 4                              | 10   | 6  |
| H-8                          | Setback Thermostats             | 135  | 9                              | 22   | 6  |
| D-2                          | Flow Controls                   | 19   | 14                             | 34   | 0.5  |
| D-3                          | Insulate Storage                | 30   | 8                              | 20   | 1.5  |
| D-4                          | Hot Water Vens Damper           | 150  | 6                              | 15   | 10   |
| <u>Moderate Capital Cost</u> |                                 |  |                                |  |  |
| E-3                          | Storm Windows                   | 450  | 11                             | 27   | 17   |
| E-6                          | Window Insulation               | 420  | 4                              | 10   | 42   |
| H-10                         | Replace Window Air Conditioners | 890  | 13                             | 32   | 28   |
| <u>High Capital Cost</u>     |                                 |  |                                |  |  |
| E-2                          | Wall Insulation                 | 4664                                       | 23                             | 57   | 82   |
| H-5                          | Heat Pumps                      | 3680                                       | 19                             | 47   | 78   |

Table A7: Retrofit Options for a Large Multi-Family  
Buildings with Masonry Walls and Central  
Air Heating and Cooling

| Retrofit<br>Number           | Name of Retrofit                  | Total<br>Cost Of<br>Retrofit Per Ft <sup>2</sup> | Annual Savings<br>in Million Btus<br>(not fuel-adjusted) | Annual<br>Savings in<br>Million Btus<br>(fuel-adjusted) | Total Retrofit<br>Cost Per Annual<br>Million Btu Saved<br>(fuel adjusted) |
|------------------------------|-----------------------------------|--|--|---|---|
| E-9                          | Roof Spray                        | \$3750   | 408  | 1004  | 4   |
| H-3                          | Vent Damper                       | 1600   | 369  | 369   | 4   |
| H-8                          | Setback Thermostats               | 4320   | 579  | 579   | 7   |
| H-12                         | Vary chilled Water<br>Temperature | 3200   | 180  | 443   | 7   |
| H-20                         | 2 Speed Motors                    | 975  | 322  | 725   | 1   |
| D-2                          | Flow Controls                     | 1550   | 1244   | 1244  | 1   |
| D-4                          | Hot Water Vent Damper             | 225  | 340  | 340   | 0.5   |
| L-2                          | Hybrid Lamps                      | 9310   | 718  | 2869  | 3   |
| <u>Moderate Capital Cost</u> |                                   |  |  |   |   |
| E-5                          | Weatherstripping                  | 520  | 93   | 112   | 49  |
| E-6                          | Window Insulation                 | 25,200   | 631  | 631   | 40  |
| H-18                         | Insulate Ducts                    | 25,650   | 484  | 613   | 42  |
| <u>High Capital Cost</u>     |                                   |  |  |   |   |
| E-1                          | Roof Insulation                   | 30,000   | 476  | 576   | 52  |
| E-2                          | Wall Insulation                   | 216,240  | 689  | 2042  | 105   |

Table A8: Retrofit Options for a Large Multi-family Building with Masonry Walls, Central Water Heating System and Window Air Conditioners

| Retrofit Number              | Name of Retrofit                  | Total Cost of Retrofit | Retrofit Cost Per Ft <sup>2</sup> | Annual Savings in Million Btus (not fuel-adjusted) | Annual Savings in Million Btus (fuel-adjusted) | Total Retrofit Cost Per Annual Million Btu Saved (fuel adjusted) |
|------------------------------|-----------------------------------|------------------------|-----------------------------------|--|--|--|
| <u>Low Capital Cost</u>      |                                   |                        |                                   |  |  |  |
| E-9                          | Roof Spray                        | \$3750                 | \$.03                             | 605  | 3  |  |
| H-1                          | Replace Burner                    | 4300                   | .04                               | 664  | 664  | 6  |
| H-3                          | Vent Damper                       | 1600                   | .02                               | 369  | 369  | 4  |
| H-4                          | Stack Heat Reclaim <sup>a</sup>   | 3200                   | .03                               | 439  | 439  | 7  |
| H-7                          | Modulating Aquastat <sup>a</sup>  | 535                    | .01                               | 609  | 609  | 1  |
| H-8                          | Setback Thermostat <sup>a</sup>   | 4320                   | .04                               | 609  | 609  | 7  |
| D-2                          | Flow Controls                     | 1550                   | .02                               | 1244   | 1244   | 1  |
| D-4                          | Hot Water Ven <sup>c</sup> Damper | 225                    | .01                               | 340  | 340  | 0.5  |
| L-2                          | Hybrid Lamps                      | 9310                   | .09                               | 190  | 1569   | 6  |
| <u>Moderate Capital Cost</u> |                                   |                        |                                   |  |  |  |
| E-1                          | Roof Insulation                   | 30,000                 | .30                               | 503  | 637  | 47   |
| E-5                          | Weatherstripping                  | 5520                   | .05                               | 97   | 123  | 45   |
| E-6                          | Window Insulation                 | 25,200                 | .25                               | 631  | 631  | 40   |
| H-6                          | Boiler Turbolators                | 6720                   | .07                               | 155  | 155  | 43   |
| H-10                         | Replace Room Air Conditioners     | 39,520                 | .40                               | 619  | 1701   | 23   |
| <u>High Capital Cost</u>     |                                   |                        |                                   |  |  |  |
| E-2                          | Wall Insulation                   | 216,240                | 2.16                              | 787  | 2262   | 96   |

Table A9: Retrofit Options for a Large Multi-Family Building with Masonry Walls and Decentralized Heating and Cooling System

| Retrofit Number              | Name of Retrofit              | Total Cost of Retrofit | Retrofit Cost Per Ft <sup>2</sup> | Annual Savings in Million Btus (not fuel-adjusted) | Annual Savings in Million Btus (fuel-adjusted) | Total Retrofit Cost Per Annual Million Btu Saved (fuel adjusted) |
|------------------------------|-------------------------------|------------------------|-----------------------------------|--|--|--|
| <u>Low Capital Cost</u>      |                               |                        |                                   |  |  |  |
| E-9                          | Roof Spray                    | \$3750                 | \$.03                             | 605  | 1489   | 3  |
| H-8                          | Setback Thermostats           | 4320                   | .04                               | 302  | 743  | 6  |
| D-2                          | Flow Controls                 | 1550                   | .02                               | 1244   | 3061   | 0.5  |
| D-3                          | Insulate HOT Water Storage    | 3350                   | .03                               | 1404   | 3455   | 1  |
| A-4                          | Hot Water Vent Damper         | 225                    | .01                               | 340  | 837  | 0.5  |
| D-5                          | Hot Water Heat Pump           | 13,960                 | .14                               | 1622   | 3992   | 3  |
| L-2                          | Hybrid Lamps                  | 9310                   | .09                               | 594  | 1462   | 6  |
| <u>Moderate Capital Cost</u> |                               |                        |                                   |  |  |  |
| E-1                          | Roof Insulation               | 30,000                 | .30                               | 296  | 728  | 41   |
| E-5                          | Weatherstripping              | 5520                   | .05                               | 57   | 140  | 39   |
| E-6                          | Window Insulation             | 25,200                 | .25                               | 329  | 810  | 31   |
| H-5                          | Heat Pumps                    | 08,000                 | 1.08                              | 878  | 2161   | 50   |
| H-10                         | Replace Room Air Conditioners | 39,520                 | .39                               | 619  | 1523   | 26   |
| <u>High Capital Costs</u>    |                               |                        |                                   |  |  |  |
| E-2                          | Wall Insulation               | 216,240                | 2.16                              | 081  | 2660   | 81   |

Table A10: Retrofit Options for a Large Commercial Building with Clad Walls and Central Air Heating and Cooling

| Retrofit Number              | Name of Retrofit                            | Total Cost Of Retrofit Per Ft <sup>2</sup> | Annual Savings in Million Btus (not fuel-adjusted) | Annual Savings in Million Btus (fuel-adjusted) | Total Retrofit Cost Per Annual Million Btu Saved (fuel adjusted) |
|------------------------------|---|--|--|--|--|
| <u>Low Capital Cost</u>      |   |  |  |  |  |
| E-9                          | Roof Spray                                  | \$3750                                     | 408  | 1003   | 4  |
| H-8                          | Setback Thermostats                         | 4320                                       | 535  | 535  | 8  |
| H-9                          | Enthalpy Control                            | 3000                                       | 3010   | 7408   | 0.5  |
| H-12                         | Vary Chilled Water Temperature <sup>a</sup> | 3200                                       | 3010   | 7408   | 0.5  |
| H-14                         | Reduce Ventilation                          | 910  | 2752   | 3328   | 0.5  |
| H-20                         | 2 Speed Motors                              | 1185                                       | 172  | 410  | 3  |
| D-2                          | Flow Controls                               | 32   | 46   | 46   | 1  |
| D-3                          | Insulate Hot Water Storage                  | 590  | 37   | 44   | 13   |
| D-4                          | Hot Water Vent Damper                       | 200  | 180  | 180  | 1  |
| L-2                          | Hybrid Lamps                                | 76,390                                     | 5155   | 20,500   | 4  |
| L-4                          | HI-Effic Fluorescent                        | 12,750                                     | 417  | 1657   | 8  |
| <u>Moderate Capital Cost</u> |   |  |  |  |  |
| E-4                          | Double Glazing                              | 64,80°                                     | 1300   | 1572   | 41   |
| E-5                          | Weatherstripping                            | 600°                                       | 131  | 158  | 38   |
| E-6                          | Window Insulation                           | 37,80°                                     | 847  | 847  | 45   |
| E-8                          | Shading Devices                             | 25,38°                                     | 1300   | 1810   | 24   |
| H-3                          | Vent Damper                                 | 200°                                       | 135  | 135  | 15   |
| H-4                          | Stack Heat Reclaimer                        | 490°                                       | 331  | 331  | 15   |
| H-16                         | Water Cooled Condenser                      | 32,30°                                     | 461  | 1135   | 28   |
| H-18                         | Insulate Ducts                              | 44,60°                                     | 1368   | 2347   | 19   |
| L-3                          | Task Lighting                               | 68,00°                                     | 954  | 2616   | 26   |
| <u>High Capital Cost</u>     |   |  |  |  |  |
| E-1                          | Roof Insulation                             | 30,00°                                     | 432  | 522  | 57   |
| E-2                          | Wall Insulation                             | 133,56°                                    | 1095   | 1324   | 101  |



Table All: Retrofit Options for a Large Commercial Building with Clad Walls, Central Water Heating System and Window Air Conditioners

| Retrofit Number              | Name of Retrofit              | Total Cost Of Retrofit Per Ft <sup>2</sup> | Annual Savings in Million Btus (fuel-adjusted) | Annual Savings in Million Btus (fuel-adjusted) | Total Retrofit Cost Per Annual Million Btu Saved (fuel adjusted) |
|------------------------------|-------------------------------|--|--|--|--|
| <u>Low Capital Cost</u>      |                               |  |  |  |  |
| E-8                          | Shading Devices               | .25  | 1382   | 1924   | 13   |
| E-9                          | Roof Spray                    | .04  | 605  | 1489   | 3  |
| H-7                          | Modulating Aquastat           | .01  | 291  | 291  | 2  |
| H-8                          | Setback thermostats           | .04  | 535  | 535  | 8  |
| D-2                          | Flow Controls                 | .01  | 46   | 46   | 0.5  |
| D-4                          | Hot Water Vent Damper         | .01  | 180  | 180  | 1  |
| L-2                          | Hybrid Lamps                  | .76  | 1977   | 12,678   | 6  |
| L-4                          | Hi-Effic. Fluorescent         | 160  | 1025   | 12   |  |
| <u>Moderate Capital Cost</u> |                               |  |  |  |  |
| E-4                          | Double Glazing                | .65  | 1382   | 1749   | 37   |
| E-5                          | Weatherstripping              | .06  | 135  | 171  | 35   |
| E-6                          | Window Insulation             | .38  | 847  | 847  | 45   |
| x-1                          | Replace Burner                | .05  | 285  | 285  | 18   |
| x-4                          | Stack Heat Reclaimer          | .05  | 331  | 331  | 15   |
| x-10                         | Replace Room Air Conditioners | .76  | 695  | 1710   | 44   |
| <u>High Capital Cost</u>     |                               |  |  |  |  |
| E-1                          | Roof Insulation               | .30  | 459  | 581  | 52   |
| E-2                          | Wall Insulation               | 1.33                                       | 1161   | 1470   | 91   |
| L-3                          | Task Lighting                 | .68  | 366  | 1168   | 58   |

Table A12: Retrofit Options for a large Commercial Building with Clad Walls and Decentralized Heating and Cooling

| Retrofit Number              | Name of Retrofit              | Total Cost Of Retrofit Per Ft <sup>2</sup> | Annual Savings in Million Btus (not fuel-adjusted) | Annual Savings in Million Btus (fuel-adjusted) | Total Retrofit Cost Per Annual Million Btu Saved (fuel-adjusted) |
|------------------------------|-------------------------------|--|--|--|--|
| <u>Low Capital Cost</u>      |                               |  |  |  |  |
| E-8                          | Shading Devices               | .25  | 811  | 1996   | 13   |
| E-9                          | Roof Spray                    | .04  | 605  | 1489   | 3  |
| H-8                          | Setback Thermostats           | .04  | 312  | 768  | 6  |
| D-2                          | Flow Controls                 | .01  | 46   | 113  | 0.5  |
| D-3                          | Insulate Hot Water Storage    | .01  | 22   | 54   | 11   |
| L-2                          | Hybrid Lamps                  | .6   | 4209   | 10,358   | 7  |
| <u>Moderate Capital Cost</u> |                               |  |  |  |  |
| E-1                          | Roof Insulation               | .30  | 296  | 728  | 41   |
| E-4                          | Double Glazing                | .65  | 911  | 2242   | 29   |
| E-5                          | Weatherstripping              | .06  | 84   | 207  | 29   |
| E-6                          | Window Insulation             | .38  | 494  | 1216   | 31   |
| H-10                         | Replace Room Air Conditioners | .76  | 695  | 1710   | 44   |
| L-3                          | Task Lighting                 | .68  | 779  | 1917   | 35   |
| L-4                          | Hi-Effic. Fluorescent         | .13  | 341  | 839  | 15   |
| <u>High Capital Cost</u>     |                               |  |  |  |  |
| E-2                          | Wall Insulation               | 1.34                                       | 763  | 1878   | 71   |

Table A13: Retrofit Options for a Large Commercial Building with Clad Walls and Complex Reheat Heating and Cooling System

| Retrofit Number              | Name of Retrofit                      | Total Cost Of Retrofit Per Ft <sup>2</sup> | Annual Savings in Million Btus (not fuel-adjusted) | Annual Savings in Million Btus (fuel-adjusted) | Total Retrofit Cost Per Annual Million Btu Saved (fuel adjusted) |
|------------------------------|---------------------------------------|--|--|--|--|
| <u>Low Capital Cost</u>      |                                       |  |  |  |  |
| E-9                          | Roof Spray                            | 3750                                       | 412  | 1014   | 4  |
| H-1                          | Replace Burner                        | 5000                                       | 2117   | 2117   | 2  |
| H-3                          | Vent Damper                           | 2000                                       | 774  | 774  | 3  |
| H-4                          | Stack Heat Reclaimer                  | 4900                                       | 2835   | 2835   | 2  |
| H-6                          | Boiler Turbolators                    | 8850                                       | 856  | 856  | 10   |
| H-8                          | Setback Thermostats                   | 4320                                       | 433  | 433  | 10   |
| H-13                         | Convert Reheat to Variable Air Volume | 13,760                                     | 3674   | 4496   | 3  |
| D-2                          | Flow Controls                         | 32   | 46   | 46   | 0.5  |
| D-4                          | Hot Water Vent Damper                 | 200  | 180  | 180  | 1  |
| L-2                          | Hybrid Lamps                          | 76,390                                     | 2413   | 12,259   | 6  |
| L-3                          | Hi-Effic. Fluorescent                 | 12,750                                     | 195  | 991  | 13   |
| <u>Moderate Capital Cost</u> |                                       |  |  |  |  |
| E-4                          | Double Glazing                        | 64,800                                     | 327  | 409  | 73   |
| E-5                          | Weatherstripping                      | 6000                                       | 108  | 135  | 44   |
| E-6                          | Window Insulation                     | 37,800                                     | 847  | 1059   | 36   |
| E-8                          | Shading Devices                       | 25,380                                     | 1082   | 1506   | 17   |
| H-18                         | Insulate Ducts                        | 44,600                                     | 1151   | 1974   | 17   |
| D-3                          | Insulate Hot Water Storage            | 590  | 30   | 35   | 17   |
| <u>High Capital Cost</u>     |                                       |  |  |  |  |
| E-1                          | Roof Insulation                       | 30,000                                     | 327  | 409  | 73   |
| H-16                         | Water Cooled Condenser                | 32,300                                     | 153  | 376  | 86   |
| L-3                          | Task Lighting                         | 68,000                                     | 447  | 1315   | 52   |

# Estimated Cumulative Energy Savings From Packages of Retrofits for Thirteen Different Building Types

This appendix illustrates the effect of forming three packages of retrofits for each of the 13 building types for which retrofit options were presented in appendix A. One package contains a set of nonoverlapping retrofits of low capital cost; a second package includes a set of retrofits of moderate capital cost compared to savings; and a third package contains retrofits of high capital cost compared to savings.

For each building type there is a graph that shows cumulative energy savings as low, moderate, and high capital cost retrofit packages are added to that building. The cost per million Btu of each package is shown on the vertical axis of each graph. Because of interactive effects the cost per annual million Btu saved may fall outside the capital cost thresholds established by OTA for individual retrofits even though all the individual retrofits in the package would fall within the threshold if installed separately. This happens occasionally for the low capital cost package, more frequently for the moderate cost package, and very frequently for the high cost package.

For example, when combined into a package the low capital cost retrofits to a clad wall commercial building with an air system will cost \$26 per annual million Btu saved ("fuel-adjusted"\*) even though

each of the retrofits in the package will cost no more than \$14 per annual million Btu saved if done individually. For the rest of the building types, however, the cost per annual million Btu of the low cost retrofit package lies within the low capital cost threshold.

Similarly, for several of the commercial buildings the cost per annual million Btu saved of the moderate cost package is somewhat higher than the moderate capital cost threshold of \$49 per annual million Btu saved even though individual retrofits in the package cost less than that. Several of the high capital cost retrofit packages cost substantially more than the high capital cost threshold. The rest cost a little more. These results indicate that high capital cost retrofits would not be cost effective if done after all low capital cost and all moderate capital cost retrofits had been installed.

For convenience the list of retrofits included in each retrofit package is given at the right of each graph. There are a few differences between these lists and those shown in appendix A. In most cases this is because some interactive effects among retrofits were anticipated in assigning individual retrofits to retrofit packages.

\*See explanation of "fuel-adjusted" in introduction to appendix A.

**Figure B-1.—Small Frame House: Air System\***  
**V: Retrofit cost—\$/million Btu saved**  
**H: Annual million Btu saved**

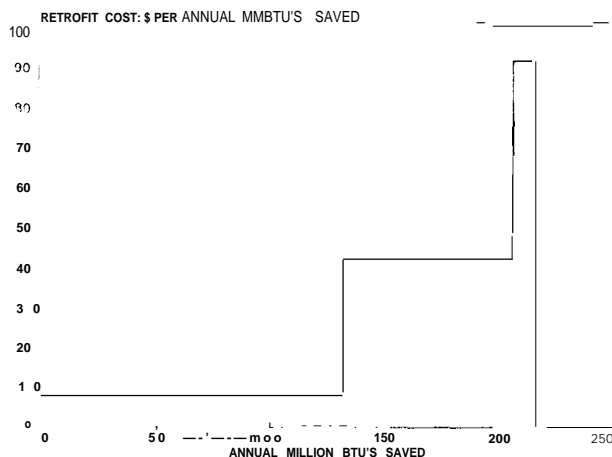

● Base annual energy use = 575 million Btu "fuel-adjusted."

### Retrofits included in Low, Moderate, and High Cost Packages for Analysis of Cumulative Savings

#### Small Frame House With an Air System

| <i>Low*</i>          | <i>Moderate•</i> | <i>High •</i>     |
|----------------------|------------------|-------------------|
| Wall insulation      | Roof insulation  | Window insulation |
| Weatherstripping     | Storm windows    |                   |
| Thermostats          | Vent damper      |                   |
| 2-speed fan motor    | Insulate ducts   |                   |
| Flow controls        | DHW vent damper  |                   |
| Insulate DHW storage |                  |                   |

\*Capital cost compared to savings.

**Figure B-2.—Small Frame House: Water System\***

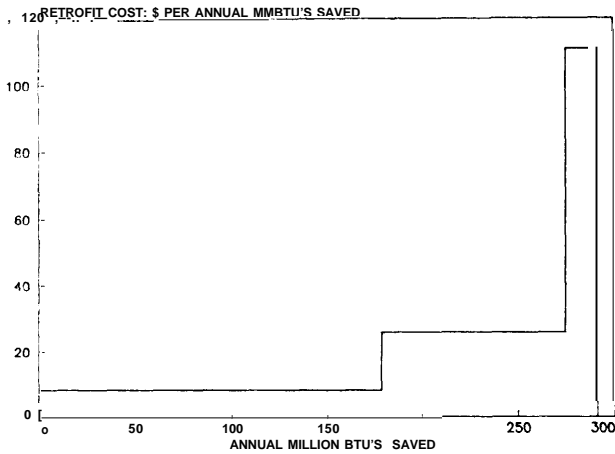

● Base annual energy use = 628 million Btu "fuel-adjusted."

**Retrofits Included in Low, Moderate, and High Cost Packages for Analysis of Cumulative savings**

**Small Frame House With a Water System**

- |   |  |   |
|---|--|---|
| <p><i>Low*</i></p> <ul style="list-style-type: none"> <li>Roof insulation</li> <li>Wall insulation</li> <li>Weatherstripping</li> <li>Thermostats</li> <li>Flow controls</li> <li>Insulate DHW storage</li> </ul> | <p><i>Moderate•</i></p> <ul style="list-style-type: none"> <li>Storm windows</li> <li>Vent damper</li> <li>Modular aquastat</li> <li>Replace room AC</li> <li>DHW vent damper</li> </ul> | <p><i>High•</i></p> <ul style="list-style-type: none"> <li>Window insulation</li> <li>Replace burner</li> </ul> |
|---|--|---|

**Figure B-3.-Small Frame House: Decentralized System\***

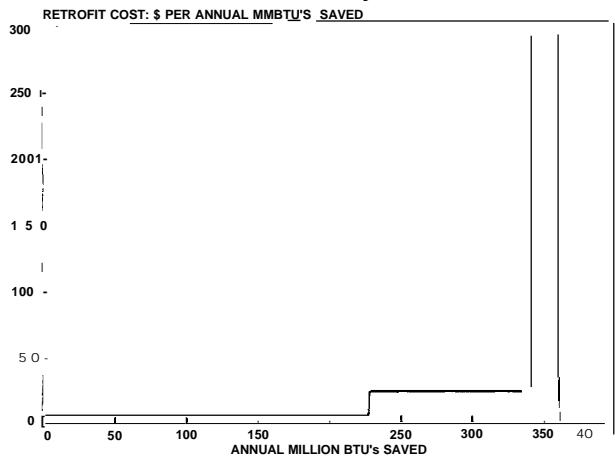

● Base annual energy use = 705 million Btu "fuel-adjusted."

**Small Frame House With a Decentralized System**

- |  |   |  |
|--|---|--|
| <p><i>Low*</i></p> <ul style="list-style-type: none"> <li>Roof insulation</li> <li>Wall insulation</li> <li>Weatherstripping</li> <li>Flow controls</li> <li>Insulate storage</li> </ul> | <p><i>Moderate•</i></p> <ul style="list-style-type: none"> <li>Storm windows</li> <li>Window insulation</li> <li>Replace room AC</li> </ul> | <p><i>High•</i></p> <ul style="list-style-type: none"> <li>Electric heat pump</li> </ul> |
|--|---|--|

● Capital cost compared to savings.

**Figure B-4.—Small Masonry Rowhouse: Air System\***

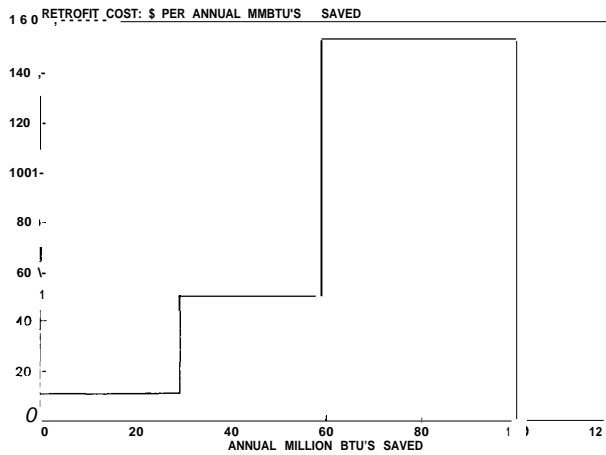

● Base annual energy use = 404 million Btu "fuel-adjusted."

**Retrofits Included in Low, Moderate, and High Cost Packages for Analysis of Cumulative Savings**

**Small Masonry Rowhouse With an Air System**

- |  |  |  |
|--|--|--|
| <p><i>Low*</i></p> <ul style="list-style-type: none"> <li>Weatherstripping</li> <li>Thermostats</li> <li>2-speed fan motor</li> <li>Flow controls</li> <li>Insulate storage</li> </ul> | <p><i>Moderate•</i></p> <ul style="list-style-type: none"> <li>Roof insulation</li> <li>Storm windows</li> <li>Vent damper</li> <li>DHW vent damper</li> </ul> | <p><i>High•</i></p> <ul style="list-style-type: none"> <li>Wall insulation</li> <li>Window insulation</li> <li>Insulate ducts</li> </ul> |
|--|--|--|

**Figure B-5.—Small Masonry Rowhouse: Water System\***

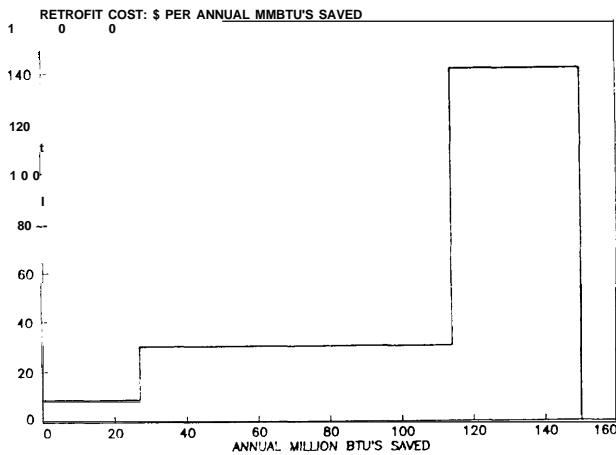

\*Base annual energy use = 436 million Btu "fuel-adjusted."

**Small Masonry Rowhouse With a Water System**

- |   |   |  |
|---|---|--|
| <p><i>Low*</i></p> <ul style="list-style-type: none"> <li>Weatherstripping</li> <li>Thermostats</li> <li>Flow controls</li> <li>Insulate storage</li> </ul> | <p><i>Moderate"</i></p> <ul style="list-style-type: none"> <li>Roof insulation</li> <li>Storm windows</li> <li>Vent damper</li> <li>Modular aquastat</li> <li>Replace room AC</li> <li>DHW vent damper</li> </ul> | <p><i>High•</i></p> <ul style="list-style-type: none"> <li>Wall insulation</li> <li>Window insulation</li> </ul> |
|---|---|--|

● Capital cost compared to savings.

**Figure B-6.—Small Masonry Rowhouse: Decentralized System\***

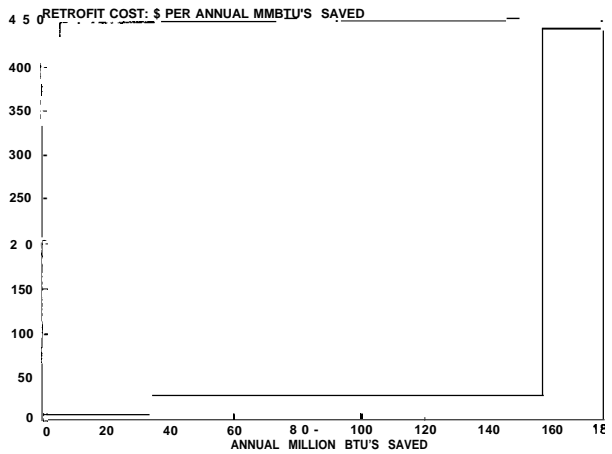

\*Base annual energy use = 466 million Btu "fuel-adjusted."

**Retrofits Included in Low, Moderate, and High Cost Packages for Analysis of Cumulative Savings**

**Small Masonry Rowhouse With a Decentralized System**

| <i>Low</i>       | <i>Moderate</i>   | <i>High</i>        |
|------------------|-------------------|--------------------|
| Weatherstripping | Roof insulation   | Wall insulation    |
| Thermostats      | Storm windows     | Electric heat pump |
| Flow controls    | Window Insulation |                    |
| Insulate storage | Replace room AC   |                    |
|                  | DHW heat pump     |                    |

**Figure B-7.—Large Multifamily Building: Air System\***

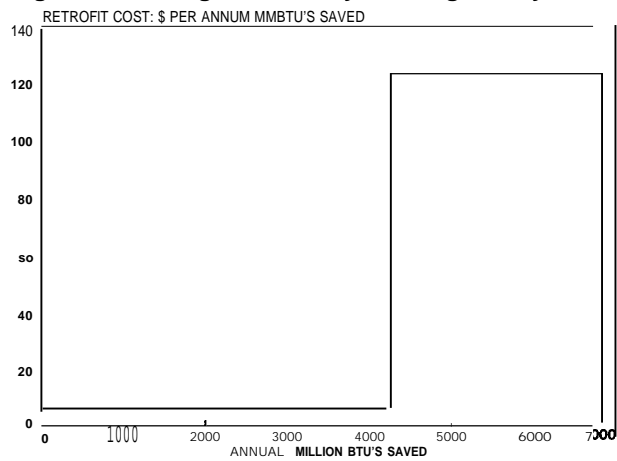

\*Base annual energy use = 12,985 million Btu "fuel-adjusted."

**Large Multifamily Building With an Air System**

| <i>Low</i>        | <i>Moderate</i>        | <i>High</i>      |
|-------------------|------------------------|------------------|
| Roof spray        | Window Insulation      | Roof insulation  |
| Vent damper       | Water-cooled condenser | Wall Insulation  |
| Thermostats       | Insulate ducts         | Weatherstripping |
| Enthalpy control  |                        |                  |
| Vary CHW temp     |                        |                  |
| 2-speed fan motor |                        |                  |
| Flow controls     |                        |                  |
| DHW vent damper   |                        |                  |
| Hybrid lamps      |                        |                  |

\*Capital cost compared to savings.

**Figure B-8.—Large Multifamily Building: Water System\***

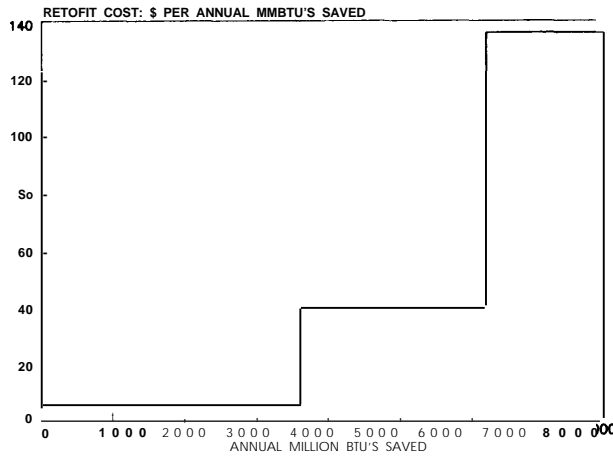

\*Base annual energy use = 13,950 million Btu "fuel-adjusted."

**Retrofits included in Low, Moderate, and High Cost Packages for Analysis of Cumulative Savings**

**Large Multifamily Building With a Water System**

- |                  |                   |                   |
|------------------|-------------------|-------------------|
| <i>Low*</i>      | <i>Moderate•</i>  | <i>High•</i>      |
| Roof spray       | Roof insulation   | Wall insulation   |
| Vent damper      | Weatherstripping  | Boiler turbotator |
| Modular aquastat | Window insulation |                   |
| Thermostats      | Replace burner    |                   |
| Flow controls    | Replace room AC   |                   |
| DHW vent damper  |                   |                   |

**Figure B-9.—Large Multifamily Building: Decentralized System\***

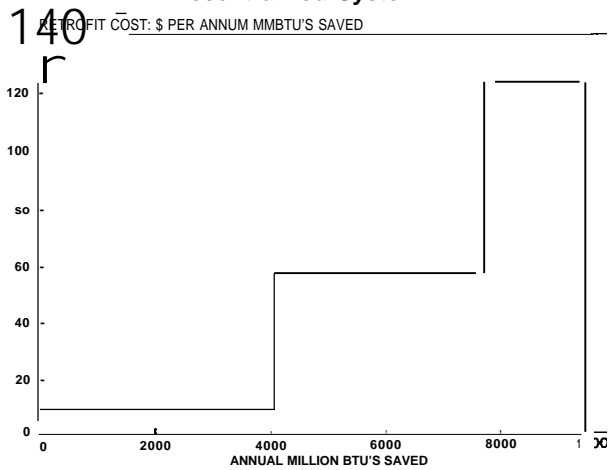

● Base annual energy use = 14,923 million Btu "fuel-adjusted."

**Large Multifamily Building With a Decentralized System**

- |                  |                    |                 |
|------------------|--------------------|-----------------|
| <i>Low*</i>      | <i>Moderate</i>    | <i>High•</i>    |
| Roof spray       | Roof insulation    | Wall insulation |
| Thermostats      | Weatherstripping   |                 |
| Flow controls    | Window insulation  |                 |
| Insulate storage | Electric heat pump |                 |
| DHW heat pump    | Replace room AC    |                 |
| Hybrid lamps     |                    |                 |

\*Capital cost compared to savings.



**Figure B-10.—Large Commercial Building:  
Air System\***

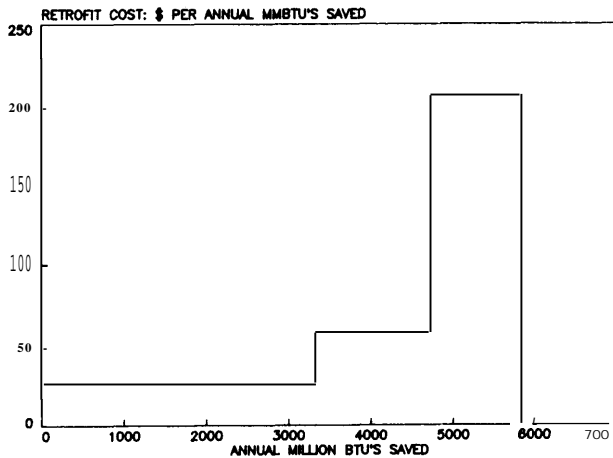

\*Base annual energy use = 10,545 million Btu "fuel-adjusted."

**Retrofits Included in Low, Moderate, and High Cost Packages for Analysis of Cumulative Savings**

**Large Commercial Building With an Air System**

- | <i>Low*</i>                 | <i>Moderate•</i> | <i>High•</i>           |
|-----------------------------|------------------|------------------------|
| Roof spray                  | Weatherstripping | Roof Insulation        |
| Vent damper                 | Shading devices  | Wall Insulation        |
| Thermostats                 | Replace burner   | Window insulation      |
| Enthalpy control            | Insulate ducts   | Water-cooled condenser |
| Vary CHW temp               |                  |                        |
| Reduce ventilation          |                  |                        |
| 2-speed fan motor           |                  |                        |
| Flow controls               |                  |                        |
| Insulate storage            |                  |                        |
| DHW vent damper             |                  |                        |
| Task lighting               |                  |                        |
| High-efficiency fluorescent |                  |                        |

**Figure B-11.—Large Commercial Building:  
Water System\***

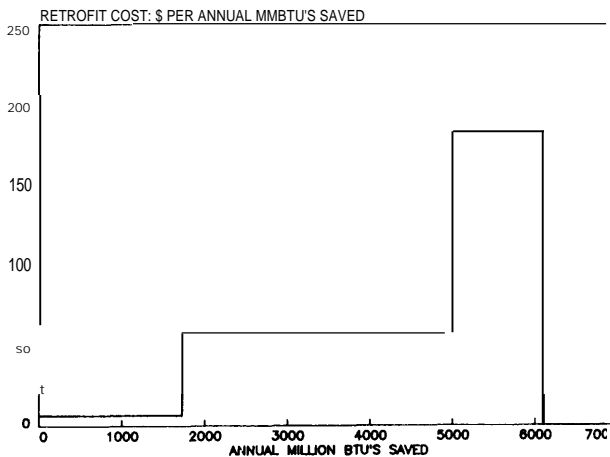

● Base annual energy use = 10,579 million Btu "fuel-adjusted."

**Large Commercial Building With a Water System**

- | <i>Low*</i>                 | <i>Moderate</i>  | <i>High•</i>      |
|-----------------------------|------------------|-------------------|
| Roof spray                  | Weatherstripping | Roof insulation   |
| Vent damper                 | Shading devices  | Wall insulation   |
| Modular aquastat            | Replace burner   | Window insulation |
| Thermostats                 | Replace room AC  |                   |
| Flow controls               | Task lighting    |                   |
| Insulate storage            |                  |                   |
| DHW vent damper             |                  |                   |
| High-efficiency fluorescent |                  |                   |

● Capital cost compared to savings.

**Figure B-12.—Large Commercial Building: Decentralized System\***

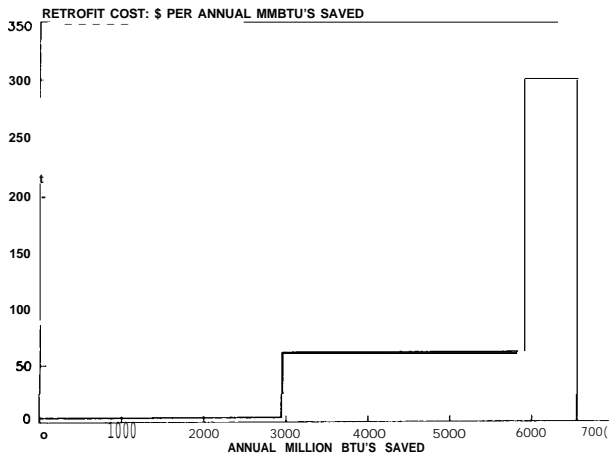

\*Base annual energy use = 10,882 million Btu "fuel-adj. justed."

**Retrofits Included in Low, Moderate, and High Cost Packages for Analysis of Cumulative Savings**

**Large Commercial Building With a Decentralized System**

- |                             |                   |                 |
|-----------------------------|-------------------|-----------------|
| <i>Low*</i>                 | <i>Moderate •</i> | <i>High •</i>   |
| Shading devices             | Roof insulation   | Wall insulation |
| Roof spray                  | Weatherstripping  |                 |
| Thermostats                 | Window insulation |                 |
| Flow controls               | Replace room AC   |                 |
| Insulate storage            | Task lighting     |                 |
| High-efficiency fluorescent |                   |                 |

**Figure B-13.—Large Commercial Building: Reheat System\***

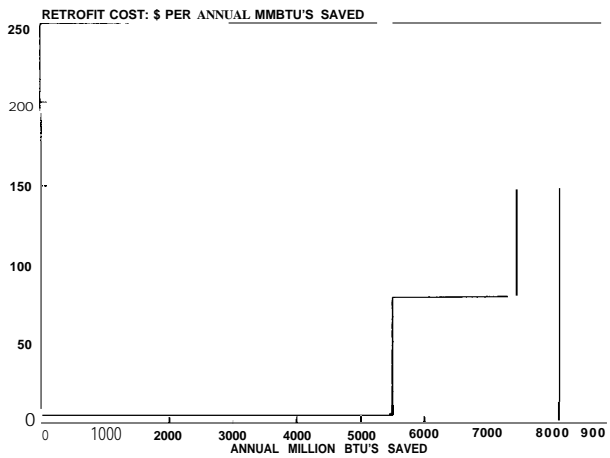

\*Base annual energy use = 13,705 million Btu "fuel-adjusted."

**Large Commercial Building With a Complex Reheat System**

- |                             |                   |                        |
|-----------------------------|-------------------|------------------------|
| <i>Low*</i>                 | <i>Moderate •</i> | <i>High"</i>           |
| Roof spray                  | Weatherstripping  | Roof insulation        |
| Replace burner              | Shading devices   | Window insulation      |
| Vent damper                 | Boiler turbotator | Water-cooled condenser |
| Thermostats                 | Insulate ducts    |                        |
| Reheat to VAV               | Insulate storage  |                        |
| Flow controls               | Task lighting     |                        |
| DHW vent damper             |                   |                        |
| High-efficiency fluorescent |                   |                        |

● Capital cost compared to savings.

## Appendix C

# Retrofit Descriptions

---

This appendix includes descriptions of 52 possible retrofits to buildings. The set includes descriptions of seven active and passive solar retrofits for which costs and benefits are shown in appendix D. The set also includes eight retrofits for which costs and/or savings were not estimated because conditions affecting costs and savings vary enormously from building to building. These retrofits were described in chapter 3 and include:

- HVAC-21: Install adjustable radiator vents
- HVAC-22: Reduce orifice size on furnace/boiler
- HVAC-23: Install multifuel/solid fuel boiler
- HVAC-24: Install house fans

HVAC-25: Condenser coil spray

HVAC-26: Chiller bypass system

DEW-6: Refrigeration heat reclaims for domestic hot water

L-5: Maximize use of daylighting

The list of retrofits was initially developed by Energyworks of West Newton, Mass. and was adjusted and expanded in consultation with members of a Retrofit Review workshop that met for two days in October 1980. The members of the workshop were professional energy auditors, architects and building retrofit researchers. Their names are listed in the acknowledgments at the front of the report.

### 5.2.3 Prose Descriptions of Energy Conservation Measures

#### E-1 ROOF/ATTIC INSULATION

The base building model assumes a pitched or flat roof over an uninsulated attic or crawl space in the single family case, and a flat roof with 1/2-inch to 3/4-inch of older roof deck insulation for all other building types. Four inches of loose fill insulation is installed in attics/crawl spaces, and two inches of high-resistance roof deck insulation, such as polystyrene or urethane-polystyrene composite, is added to flat roofs. The cost of roof deck insulation includes the cost of replacing roofing over the new insulation. The unit cost for insulating flat roofs is much higher than that for attics or crawl spaces.

The life of the measure is indefinite if properly protected. In attics or crawl spaces, leakage through the roof or failure to properly vent the space can cause moisture damage. Roof deck insulation must be protected by maintaining the roofing.

The calculated results are highly dependent on the base case thermal properties. For older flat-roofed buildings, assuming a thin layer of fiber-type insulation board is realistic for most cases. The model is less dependable for the single-family case; while it was necessary to assume a 'worst case' of no insulation, many houses have some, which may vary widely in thickness, type, and insulating value. For example, adding four inches of loose fill to an attic already having two inches of somewhat compacted rock wool yields savings only 64% of the base case, or increases the cost/savings ratio by a factor of 1.56.

Where heating is electrical, this measure may yield additional savings through reduction of demand charges, which are not included in the calculations.

#### E-2 WALL INSULATION

The base building model assumes uninsulated walls for all wall types, which is representative of most older building stock. For cavity walls, 3 1/2 inches of loose fiberglass or cellulose is blown in. For masonry bearing walls (MBW) and clad walls, rigid insulation is fastened to the outside or inside walls, whichever is more feasible structurally and aesthetically. For either application, it is necessary to cover the insulation with wall board (interior) or a masonry finish compound (exterior). A combination of aesthetic and practical considerations may make this measure impossible in some buildings.

Costs of rigid wall insulation may vary widely, according to method used and availability of local contractors with experience in that type of work. Experience with retrofit insulation of MBW and clad walls is generally limited, and there may be long-term maintenance costs or problems that have

not yet been uncovered.

Insulation of walls may improve the comfort level enough to permit lower winter thermostat settings in some cases, due to elimination of "cold wall" discomfort; this has not been included in the algorithm. Also not included are possible reductions in demand charges where heating is electrical.

#### E-3 STORM WINDOWS

Aluminum-frame combination storm windows are installed over single-glazed wood or metal framed double-hung windows, reducing both conduction heat loss and air infiltration. The base building model assumes "average fit" for the existing windows, and reduction of infiltration load is calculated by ASHRAE criteria. Savings would be greater if existing windows are exceptionally loose, less if they are already tight or weatherstripped. Therefore, savings may vary with a building's age and maintenance condition.

Maintenance requirements may include lubrication and/or occasional replacement of built-in weatherstripping. A measure life of twenty years may be expected, varying with product quality, use, etc. The cost estimate is for "average" quality windows.

Improvement of the comfort level due to this measure is not incorporated into the algorithm. Also not included are possible reductions in demand charges where heating is electrical.

#### E-4 REPLACEMENT DOUBLE GLAZING

For buildings with double-hung windows, existing wood or metal-framed windows are removed and replaced with new, integrally-weatherstripped, double-glazed units. For all other window types, a second layer of glazing is fitted to the existing sash, by the "deadlite" or similar method.

Base case assumptions are as described above for E-3. Reductions in infiltration load are calculated for double-hung windows, but not for other types, as the method for casement and projected windows does not involve sash replacement or change the sash fit.

Costs may vary widely according to the quality of replacement windows used, or the method used for installing additional glazing. The costs used here assume average quality replacement and glazing added by attachment with magnetic strips.

#### E-5 WINDOW AND DOOR WEATHER STRIPPING

For the single-family case (P/U 1), plastic or rubber gasket weatherstripping is installed on all doors and windows. Rigid-backed weatherstripping is used on doors. For all other building types, spring

bronze is installed on doors and in window sashes, where feasible. On some windows, foam or rubber gasket weatherstripping may be more practical. As with E-3 and E-4, unweatherstripped doors and windows of "average fit" are assumed for the base case. Actual savings may be less than those calculated when some weatherstripping already exists? greater when doors and/or windows are very loose.

Actual cost of weatherstripping can vary considerably. In the single-family case, installation by the occupant is assumed. Costs are estimated for highest quality materials and installation in all cases.

Life of this measure varies from 1 to 2 years for some plastic or foam types to indefinitely for well-maintained spring bronze. Maintenance and/or replacement costs are not included in the calculation.

#### E-6 WINDOW INSULATION

Quilted, polyester fiberfill-lined window shades are installed on all windows. A track or magnetic fastening system is provided to maintain a good air seal between the shade and the window. It is assumed that the device is in place an average of eight hours per day throughout the heating season, and is used on an average of 75% of the windows at *any given* time. An effective value of R-3 is added to the window units.

The base case assumes single-glazed windows, which are representative of most older Urban buildings. Where double-glazed windows exist, savings would be about 48% of those calculated.

The savings are highly dependent on behavior; use for more hours or on more of the windows than indicated would yield proportionally greater savings. There is also some variation depending on the exact device used (various types of thermal shutters or other shade types are only roughly equivalent) and the quality of insulation.

Savings are calculated for use during night-time temperature conditions. Daytime use would yield additional savings at a somewhat lower rate. The effective life of this measure is not yet known.

#### E-7 REFLECTIVE FILMS

Reflective window films are applied directly to the glazing in commercial buildings (P/U types of 3 and 4). Effective solar transmission is reduced by 72% and effective thermal transmission (U-value) by 29%. This measure refers specifically to products that are designed to reduce heating load as well as cooling load.

The base case specifies single-glazed windows, which is representative as discussed above. Existence of double-glazed windows would have little impact on the solar-gain reducing aspect, but would greatly reduce the

savings in heating load, which is a major part of the total.

Preliminary results show this measure as more cost-effective in cold climates than in warm, which runs counter to expected results. There are two major reasons for this:

1. Manufacturers literature claims reductions in heat loss as indicated above; independent laboratory test results to confirm or deny these figures is not yet available. The current calculations indicate that measure has a much greater impact on heating load than on cooling load, hence the greater cost-effectiveness in cold climates.
2. *The* building models are very limited as models for solar heat gain. A rectangular shape, with windows evenly distributed with respect to orientation and unshaded condition are assumed. Real-case buildings seldom have these characteristics. In some cases, as in buildings with a great deal of west-exposed glazing, solar heat gain may have a much greater impact on cooling load, and therefore the cooling aspect of this measure could predominate.

If this measure is highly effective in reducing radiant heat loss through glazing, improvements in comfort level (possibly enabling lower winter thermostat settings) could add to the measure's cost-effectiveness for heating.

On the other hand, the measure could have a negative effect if used on south-exposed windows that were valuable sources of solar heat gain in the winter, particularly where the windows were double-glazed or had night insulation.

Expected life of reflective films is not *yet* known.

#### E-8 SHADING DEVICES

Exterior-mounted fiberglass screen shading devices are installed over windows in commercial buildings. Devices are used on all sides of the building in the summer, and all sides except south in the winter, to take advantage of useful winter solar heat gain. The devices act as storm windows, reducing conductive heat loss and infiltration~ as well as reducing solar heat gain. This measure is modeled specifically for removable devices. Savings are calculated with the assumption that the building's windows are single glazed, as described in the building models. Savings would be reduced for double-glazed windows, as discussed above for E-6.

Several factors should be considered in evaluating the calculated savings:

1. Actual costs may vary widely according to the exact type of device used.
2. Asmodeled, the devices would be installed over operable windows.

Compliance with building codes may be an issue in some cases. However, commercial buildings are modeled with the assumption that mechanical ventilation is provided; therefore windows would not ordinarily be required as a ventilation source and covering time would not pose a problem.

3. The annual cost of setting up and removing devices from the south side has not been included in the calculations.

4. The limitations of the building model for modeling solar gain, as discussed above for E-7, would apply here.

5. The effective life of such devices is not yet known.

#### E-9 ROOF SPRAYS

A roof spray system is installed on flat roof buildings to reduce roof surface temperatures through evaporation, thus reducing heat gain and reducing the cooling load. The base case assumes a dark-colored flat roof, with thermal properties as described in the building models. Savings are calculated assuming the system is operated an average of ten hours per day during the cooling season, and actual sun conditions are taken into consideration for the various climate zones.

The assumed thermal properties of the roof are fairly representative of older buildings which have not already been retrofitted with roof insulation. Savings for well-insulated roofs would be reduced in proportion to the difference in U-value from the base model. The assumption of a dark-colored roof, while also fairly representative of real buildings, is very crucial to the results. Savings for a light-colored, reflective roof could be as little as one-quarter of those calculated.

Cost of this measure could be greater than the assumed value where the installation presents structural problems, or where extensive additional piping must be installed inside the building to handle the water requirements. The cost of water was also not considered in the calculations.

Damage to the roof from water should not occur where the roofing is in good condition and does not have drainage problems. Evaporation would ordinarily be sufficient to prevent pooling on the roof where the system's controls are operating properly.

#### HVAC-1 REPLACE BURNER AND CONTROLS

Existing oil-fired burner head is replaced with new retention-head burner and appropriate controls, to improve operating efficiency. The base case assumes a single-pass, vertical fire tube, dry-base conventional boiler.

The savings from this measure are highly dependent on the original



efficiency of the equipment, which is a condition of the type and condition of burner and controls, the condition of air intakes, boiler jacket, flue, and tubes, as well as the basic boiler type as described above. Any assumption made about system efficiency is, by necessity, based on a rough estimate only, the real cases may vary widely due to differences in the factors discussed above. An attempt was made to model representative older equipment that has been maintained in good condition but does not incorporate modern features that contribute to overall efficiency such as improved jacket insulation, more efficient fuel dispersion and fuel-air mixing, etc.

Another shortcoming of this algorithm is that it is based specifically on oil-fired water-heating equipment, although savings for oil-fired air furnaces should be roughly comparable. Improvements in the efficiency of gas-burning equipment may be less than those calculated.

Also, the calculated savings will result only where the equipment is well maintained and tuned periodically. This is assumed part of a normal maintenance program and maintenance costs are not included in the calculations. The new burner could be expected to last for the life of the boiler.

#### HVAC-2 REPLACE BOILER/FURNACE

Existing boiler plant is replaced with a new wet-base, two-pass horizontal fire tube steel boiler, with induced-draft burner. The base case is as described above for HVAC-1, and the limitations of the algorithm also apply here.

In this case, the savings are only applicable to water-heating equipment; the type of fuel burned is not a major consideration, as the major part of savings derive from improving the efficiency of the boiler itself. Opportunities to improve the efficiency of air-heating equipment are somewhat more limited.

#### HVAC-3 INSTALL VENT DAMPER ON BOILER/FURNACE

An electrically-actuated automatic vent damper is installed on the central heating plant, to reduce convection of air up the flue and loss of heat from the system when the burner is not firing (standby losses). The base case is as described for HVAC-1. As a variety of vent damper designs are available, savings may vary with exact type.

Vent dampers are generally more effective for water systems, where considerable heat is stored in the heating plant itself, and for gas-fired systems, where the flow of air through the flue during off-cycle can be considerable. Therefore, best savings are obtained for gas-fired boilers, the least for oil-fired furnaces. The savings calculated here should be interpreted as representing the mid-point of a range.

Vent dampers are a relatively new item, and the expected life of the measure is not yet known. Maintenance of the device and its control circuitry would be included in normal heating plant maintenance.

#### HVAC-4 INSTALL STACK HEAT RECLAIMER

Boiler water is preheated using reclaimed stack heat, reducing overall heating needs. This measure is applicable primarily to oil-fired boilers; savings from gas-fired boilers are expected to be less due to lower stack temperatures, making less heat available for recovery.

Stack heat reclaimers have not yet become a common item; therefore price, quality, and availability may vary. The savings estimated are based on improvement in the overall seasonal efficiency of the heating plant, as determined in tests performed by Brookhaven National Laboratories. The sample used for these tests was limited, and actual performance may vary with the initial condition of the heating plant and with the exact device used.

#### HVAC-5 REPLACE ELECTRICAL RESISTANCE WITH HEAT PUMPS

This measure is intended to improve the heating energy-efficiency of all-electric, decentralized buildings where no central distribution system exists. Therefore, substitute heating systems must be installed on a room-by-room basis and depend on no input other than electricity. One of the few options available is to install air-to-air unitary heat pumps, mounted through the wall or through window openings, similar to conventional air conditioners.

Heat pumps operate like air conditioners in reverse, cooling the outside air and transferring the heat extracted from it to the inside air. The colder the outdoor conditions, the less heat is available for extraction, and the lower the operating efficiency of the heat pump. Most heat pump systems work in conjunction with electric resistance heating, which takes over when the outdoor temperature drops too low for the heat pump to operate effectively. The overall seasonal efficiency of a heat pump is therefore strongly dependent on climate, and is roughly an inverse function of degree-days.

Heat pumps also operate for cooling in the summer; therefore this measure is modeled to replace the cooling source as well as partially replacing the heating source. Heat pumps usually operate at a somewhat lower Coefficient of Performance (COP) than conventional air conditioners in the cooling cycle, and therefore consume more energy for cooling. While exact proportions would vary with equipment, it was assumed here that the heat pump's COP is 85% of that of the cooling system it replaces. Preliminary results indicate that the heat pump measure is in some cases less cost-effective in warmer climates, rather than more as might be expected. This would be due to the reduction in cooling efficiency having a greater

effect on the savings than the increase in heating efficiency.

Several difficulties were encountered in modeling this measure, which should be kept in mind when evaluating the results:

1. Wall-mounted heat pumps are a relatively uncommon item; reliable cost and performance data was therefore difficult to obtain, and the parameters used represent a limited sample.
2. The increase in cooling energy is strongly dependent on the COP of the original equipment as well as that of the heat pump; real variations from *the* values assumed here could produce different results.
3. Sizing of heat pump systems (for developing cost estimates) presented a difficult problem. First, it is not known whether a wall-mounted system could completely replace the existing heating source, particularly for interior areas that would be far from the heat pump. While it was assumed that the heat pump system would handle the total heated area, this may not be feasible in some real cases. Also, there was some question as to whether systems should be sized to meet peak heating load (at design winter temperature) or some fraction of peak load, since the minimum operating temperatures of heat pumps vary considerably with equipment. It is assumed that the electric baseboard radiation would remain in place to supplement the heat pumps if required.

While a heat pump system would reduce overall electric consumption, there might not be any reduction in demand charges, particularly in colder climates, where peak loads would still need to be met by electric resistance heating.

#### WAC-6 INSTALL BOILER TURBULATORS

Turbulators are installed in tubes of existing fire-tube boilers to improve heat transfer between hot combustion gases and the heat exchanger, thereby improving overall operating efficiency. Stack temperature and stack heat losses are reduced. It should be noted that many boilers, including older equipment, already have turbulators as original equipment; therefore, this measure applies only where turbulators never existed, or had been removed and discarded at some previous time (before energy conservation became a high priority, turbulators were sometimes discarded to make tube cleaning easier) .

Information on energy savings from this measure is limited, and savings would tend to vary with the original boiler condition, number and configuration of tubes, and the design of a particular type of turbulator. A flat reduction of 5% in fuel consumption is consistent with test results obtained by Brookhaven National Laboratories, performed on oil-fired equipment. Savings for gas-fired equipment should be roughly comparable.

The cost of this measure is a function of the number, length, and inside

diameter of boiler tubes. A separate figure was calculated for each building type and climate zone, depending on design heating load and assumed boiler size. However, cost variations of at least +/- 25% could be expected in real cases.

#### HVAC-7 INSTALL MODULATING AQUASTAT

In most older hydronic systems, boiler water is set at a single temperature usually 160-200 degrees. The boiler cycles to maintain this temperature and the circulation system responds to the room thermostat(s). However, the system operates more efficiently where the boiler water temperature is adjusted higher to meet colder conditions, lower to satisfy milder conditions. A modulating aquastat is connected to an outdoor temperature sensor, and automatically resets boiler water temperature (usually in the range between 80 and 200 degrees) in response to outdoor temperature. While this does not reduce the space heating requirements or improve the actual combustion efficiency of the boiler, having a reduced water temperature most of the time reduces system 'parasitic' heat losses through the boiler jacket and piping. It would also reduce any tendency of the system to "overshoot" the indoor temperature requirement, thereby further reducing energy waste.

An original single-point boiler setting of 180°F is assumed in the calculation and energy savings is proportional to the variation of actual outdoor temperatures from the design temperature over the course of a heating season. An algorithm using temperature bin data is used.

A modulating aquastat should last for the life of the boiler and burner equipment, given regular and periodic calibration.

#### HVAC-8 INSTALL SETBACK THERMOSTATS

Existing room or zone thermostats are replaced with timer-actuated units, set to reduce overnight or unoccupied-zone temperatures. Base case assumption is that buildings are maintained at 65°F, 24 hours a day; after installation, temperatures are reduced to 55°F for 8 hours a day. Savings occur due to a reduction in the temperature difference between inside and outside, thereby reducing the rate of heat loss and reducing the demand on the heating system.

While setback thermostats are sometimes used to reduce cooling load as well, this measure is modeled for heating savings only. In residential buildings? it is assumed that the temperature is maintained at 78°F in the base case, and that any temperature reset to a higher point would not be feasible for reasons of comfort. In commercial buildings, it is assumed that the cooling system is already turned off during unoccupied hours, and that a temperature reset would therefore not accomplish any energy savings.

Any major variation in initial conditions from the base case would affect savings in proportion to the change in temperature difference.

The success of this measure is highly dependent on being able to maintain adequate comfort at 55°F, and on behavior of occupants. Well-insulated buildings with low infiltration rates can be adequately comfortable with an overnight setting of 55°F (of course, in commercial buildings it is assumed that they are unoccupied during setback hours). However, conditions in uninsulated, leaky buildings, which is more typical of the base building models and of much of the older urban building stock, could be nearly intolerable at 55°F. Therefore, in evaluating results, it should be kept in mind that this measure may not be feasible in some residential buildings for comfort reasons. It would tend to be most effective in conjunction with building envelope measures such as insulation and window improvement that tend to improve the comfort level.

When used with an existing heat pump system, setback thermostats will still save energy, but at a somewhat lower rate than in conventional heating systems; this is because a typical heat pump system will automatically activate the resistance backup heating on an increased call for heat when the thermostat is set up in the morning; the system will not return to the heat pump mode until the higher temperature is reached.

#### HVAC-9 INSTALL ENTHALPY CONTROL/DRY BULB ECONOMIZER

Conventional central air cooling systems operate primarily by recirculating indoor air through a cooling coil. A certain proportion of outdoor air is added to the air stream according to ventilation requirements. In many buildings, particularly in commercial buildings where internal heat gains are high, there is often a net demand for cooling even when outdoor air temperatures are much cooler than indoors. An economizer system maximizes the use of outdoor air for free cooling in such circumstances. The economizer consists of an outdoor air sensing element and a set of automatic damper operators. When there is a demand for cooling and outdoor air is sufficiently cool to contribute to meeting the demand, outdoor air dampers are opened and return air dampers shut, such that up to 100% outdoor air is circulated through the building. Successful retrofit of an economizer requires an outdoor air intake sufficiently large to handle 100% outdoor air, and an exhaust system with comparable capacity; such conditions are fairly typical in existing buildings with central air systems, and are assumed to exist in the base building model. Where an enlarged air intake or new automatic outdoor air damper are required, the cost would be somewhat higher than that assumed here.

Two major control options are available: a dry-bulb economizer operates by sensing the temperature of outdoor air; an enthalpy control system senses the enthalpy, or overall heat content (sensible plus latent) of the outdoor air. Enthalpy control therefore allows more precise control of comfort conditions and saves more energy by taking advantage of a wider range of outdoor conditions. However, enthalpy control systems have often proven unreliable in actual field conditions; humidity sensing elements have tended to be inaccurate or to require frequent servicing and adjustment. Therefore, a dry-bulb economizer is modeled for this measure. Savings are

calculated by a method developed by the Honeywell Corporation, using a climate parameter 'K' that reflects the typical free cooling potential, over the course of a season, in various climate zones. The reduced savings potential for a dry-bulb economizer is incorporated into the algorithm, which assumes that a narrower range of temperatures is useful for free cooling. This algorithm is somewhat oversimplified, and is intended for order-of-magnitude estimating. A more precise method is not currently available within the scope of this project.

#### HVAC-10 REPLACE ROOM AIR CONDITIONERS

Existing older room air conditioners are replaced with high-efficiency models in buildings with water or decentralized systems. The same cooling load is satisfied at a higher efficiency, thus reducing the energy demand. The base case assumes existing units are at least eight years old, which would be typical of older buildings and well within the lifetime of most air conditioners? and indicate a unit produced before energy-efficiency became a high priority in equipment design.

The cost-effectiveness of this measure is highly sensitive to the relative efficiency between the original and the replacement units, and major variations in either could produce very different results. The efficiency of older equipment is a function not only of its original efficiency, but also of its service history, the condition of controls, the condition and cleanliness of coils, the amount of outside air it handles etc. A reasonably well-maintained unit is assumed here. There is also a wide range in efficiencies of new equipment available; a typical mid-range point was assumed.

The costs estimated for this measure are intended to reflect mid-range for units sized to meet peak cooling load; however, variations of +/- 30% could be expected.

#### HVAC-11 REPLACE CENTRAL AIR CONDITIONING SYSTEM

For the single-family, small multifamily, and small commercial types (P/U 1, 2, 3), the existing direct-expansion (DX) compressor and condensing unit are replaced with new high-efficiency models. For the large commercial and large multifamily types (P/U 4, 5), the existing chilled water system is replaced with a new reciprocating chiller. The distinction between DX and chilled water systems is made because the large peak cooling loads of P/U types 4 and 5 would ordinarily require a chilled water system, whereas the smaller requirements of types 1, 2, and 3 could be satisfied with typical DX systems.

The discussion made above for HVAC-10, concerning possible variations in savings and cost, would also apply here. The need for replacement of central equipment is not well established, particularly in light of the high cost involved. In some cases, improved maintenance, improved control and

distribution systems, and/or partial replacement of components would be more cost-effective than total replacement of the central equipment.

#### HVAC-12 VARY CHILLED WATER TEMPERATURE WITH LOAD

Chilled water central air conditioning systems usually supply water at the temperature required to meet the maximum cooling load. Energy can be saved by varying the temperature of the chilled water in response to outdoor temperature, by a principle similar to that of a modulating aquastat (see HVAC-7), cooling the water only as much as is necessary to meet the immediate cooling load. This improves efficiency by reducing cycling of the chiller, and also by allowing the chiller to operate at a higher temperature. Controls and valving to modulate chilled water temperature are installed.

This measure is modeled for air systems in all building types except the single family. While P/U types 2 and 3 were modeled as DX systems for the purposes of measure HVAC-11, it is feasible that these types could also have chilled water systems. Therefore, this measure was modeled for P/U types 2 and 3 so that comparative data would be available.

The savings given for this measure apply specifically to Reciprocating machines. Savings would be about three times higher for centrifugal machines.

#### HVAC-13 CONVERT TERMINAL REHEAT SYSTEM TO VARIABLE AIR VOLUME (VAV)

Complex systems in commercial buildings are modeled as terminal reheat systems, which are typical of the general type of system installed before energy conservation became a major consideration. Terminal reheat systems provide very precise zone temperature control, but at the expense of very high energy consumption. For cooling, air is supplied to the entire building at the temperature required by the zone with the greatest cooling demand. The air to all other zones is reheated to provide the required temperature, an extremely wasteful process. For heating, outside air is typically mixed with the return air stream to provide the needs of the zone with the least heating requirement? which may often be *an* internal zone that actually requires cooling even in mid-winter. The supply air to all other zones is reheated to satisfy heating requirements.

A variable air volume (VAV) system operates at a single supply air temperature for each of the conditioning modes (heating and cooling), and satisfies the needs for different zones by varying the volume of air supplied. It can therefore handle transient zone conditions as well as different basic zone requirements. Energy is saved versus a terminal reheat system in three ways: the need for summer reheat is eliminated entirely; the demand on the cooling system is reduced, as a full supply of air at the temperature required by the highest-demand zone is no longer required; and the heating energy is saved by eliminating the need to mix supply air to the

needs of the zone with the least heating requirement.

The measure consists of replacing each reheat terminal with a VAV box. It is assumed that a central pneumatic control system already exists, which can be adapted to serve the needs of the VAV system. This would generally be the case in buildings already having a complex system such as terminal reheat. Installation of a completely *new* central control system could add at least 30% to the cost.

Savings are calculated with the assumption that energy is saved in each of the three categories listed above, and that initial operating conditions of the terminal reheat system are as listed on the algorithm sheet. The initial conditions are chosen on a "worst case" assumption; the magnitude of energy savings would be less where initial primary air temperatures were higher or where other initial conditions were different than specified.

Ongoing regular maintenance of the VAV system and controls is assumed; cost of maintenance is not incorporated into the calculations.

#### HVAC-14 REDUCE VENTILATION VOLUME

HVAC systems in most older commercial buildings were designed to handle a volume of outside air equivalent to about 7.5 to 10 cubic feet per minute (CFM) per occupant. In many cases, leaky or poorly-controlled outside air dampers allow an even greater volume, and also permit a considerable volume to leak through even when dampers are nominally closed. Changes in building and sanitation codes in recent years have allowed reduction of outside air to 5 CFM per occupant. Since the cost of conditioning outside air is very high, savings from ventilation reduction can be considerable. This measure is applicable to almost all commercial buildings; exception would be made only where heavy smoking or a fume-generating process necessitated a higher rate of air exchange.

Ventilation is reduced by installation of new low-leakage dampers. Damper controllers are set to permit 5 CFM of outside air per occupant during occupied hours, and to shut tightly during unoccupied hours. In calculating savings, it is assumed that the original occupied-hour volume was 7.5 CFM per occupant (typical of older obsolete building code requirements), and that the rate of leakage through shut dampers is reduced from 10% to 1% of total air volume. Savings could be greater or less with any major departure from these initial conditions.

#### HVAC-15 EVAPORATIVE COOLING SYSTEM

An evaporative cooling system operates by passing outside air through a saturated filter. Water is evaporated from the filter, and the heat required for evaporation is extracted from the air stream, *thus* lowering the air's dry-bulb temperature. The cooled air is supplied directly to the space as supplement or replacement for mechanically cooled air. The



effectiveness of the system is a function of outdoor wet-bulb temperature? which represents the lower limit to which the dry-bulb temperature of the air stream can be cooled. Therefore, the system operates only when there is a demand for cooling and the wet-bulb temperature is sufficiently low to produce the desired effect. Savings are determined by calculating the evaporative cooling potential of the outside air over the course of a cooling season in each climate zone, a function of the wet-bulb temperature profile. The method assumes that this potential can be fully utilized; therefore, it tends to overestimate the savings, by not accounting for the utilization efficiency of the system.

#### HVAC-16 REPLACE AIR-COOLED CONDENSER WITH WATER-COOLED

The efficiency of central air conditioning systems can be improved by lowering the condensing temperature, which reduces the load on the compressor. Water-cooled condensers generally provide a lower condensing temperature than air-cooled condensers, which are limited by the temperature of outside air. The effectiveness of water-cooled condensers depends on wet-bulb temperature, and therefore depends on a climatic parameter similar to WAC-15. It is assumed that the existing air-cooled condenser was maintained in good condition, and the new equipment is sized for the peak cooling load of the system. The cost of the system also includes installation of a cooling tower to cool the condensing water. Special problems, such as structural problems with a tower installation, or extra costs involved in providing an adequate water supply for the system, are not considered.

This measure is more cost-effective for residential buildings than for commercial buildings of comparable size and characteristics for the following reason: condenser and cooling tower are sized for peak cooling load, which is higher in commercial buildings due to a higher rate of internal heat gains. Therefore, the system is more costly for commercial buildings. Savings, however, are a function of seasonal cooling load, which is more nearly equal between residential and commercial, since the cooling system is assumed to operate only during occupied hours in the commercial model, and operates constantly at a lower load rate in the residential model. The net effect is to produce a lower cost/savings ratio for commercial buildings. This would tend to be true of all measures involving a system sized to peak cooling load, but where savings are proportional to overall seasonal load.

#### HW4C-17 FOG COOLING (EVAPORATOR COIL SPRAY)

A system is installed to spray cold water into the air stream leaving the evaporator (cooling) coil, which reduces the dry-bulb temperature of the air down towards the limit of its initial wet-bulb temperature. The principle of operation is similar to that for Evaporative Cooling, HVAC-15, except that return air is cooled rather than outside air. The base case assumes that the air entering the evaporator coil is at 78° dry bulb, 65° wet bulb

(50% relative humidity) . Savings would be less where' the indoor wet-bulb temperature was higher, as the potential for cooling by the fog system would be reduced. Similarly, savings could be greater with a lower initial wet-bulb temperature.

#### HVAC-18 INSULATE DUCTS

Blanket insulation of 1 1/2 inch to 2 inch thickness is installed to reduce parasitic heat gains and losses from uninsulated ductwork. The base case assumes a 135° winter supply air temperature and a 55° summer supply air temperature. Savings are reduced for terminal reheat systems, since the winter primary air temperature is lower than in simple air systems, and reheat to final supply temperature occurs at the zone terminals.

The savings for this measure are highly sensitive to the supply air temperature, the proximity of ducts to outside walls or other unconditioned spaces, and to some extent, the area of ductwork involved. Major departures from the assumed supply air temperatures would affect the savings upwards or downwards.

The cost is typical for situations where there is reasonably good access to the ductwork, such as ductwork located in basements, suspended ceiling spaces, or accessible utility chases. The cost of unusual access or wall or ceiling demolition is not included; such problems would tend to exclude this measure from consideration.

#### HVAC-19 INSULATE PIPES

In buildings with water systems, pipes are retrofitted with 1 1/2 inches to 2 inches of new insulation. The base case assumes 1/2 inch of existing insulation that may be deteriorated and of limited insulating value. While there may be some buildings with no pipe insulation at all, in which case this measure would be more cost-effective, it is much more common to find some insulation even in 50+ year old buildings. The base case of a thin layer of older insulation was considered most representative of existing building stock.

The savings are specific to systems carrying 180° water. Savings would be slightly higher but roughly comparable to systems using hotter water or low-pressure steam. Savings could be much higher in high-pressure steam systems. Pre-existence of a temperature-reducing system such as a modulating aquastat would tend to produce lower savings.

Accessibility to pipes is an important consideration in evaluating the cost. The estimate used here assumes reasonable access to most piping via basements, accessible suspended ceiling spaces, and accessible utility chases. The cost could be considerably higher where major access problems existed.

#### HVAC-20 TWO SPEED FAN MOTORS

Air systems are commonly sized to meet the peak cooling load, which usually requires a larger air volume to satisfy than the heating load, even in moderately cold climates. Systems are therefore oversized for the heating load, which reduces overall system efficiency. Installation of a 2-speed motor allows air volume to be more closely matched to seasonal requirements as well as matching lower requirements during the cooling season. Some savings in fan energy are also achieved.

A specific method for calculating savings for this measure is not yet known. It was assumed that the load-matching aspect would save about half as much energy as a specific load-matching measure such as a modulating aquastat. However, there is a need to develop a more precise algorithm.

#### HVAC-21 INSTALL ADJUSTABLE RADIATOR VENTS

Steam systems in older buildings frequently present problems with overheating, particularly where zone controls are inadequate. Adjustable air vents are installed on radiators in areas subject to overheating, and adjusted as necessary to reduce or eliminate the problem.

This measure is not quantified, since the base building model does not include modeling of zone overheating, and it would be impossible to predict any 'typical' proportion or degree of overheating. A suggested algorithm for evaluating savings in particular buildings is presented on the algorithm sheet.

#### HVAC-22 REDUCE ORIFICE SIZE ON FURNACE/BOILER

Boilers and furnaces often have firing rates well in excess even of the peak heating load requirement, and therefore operate inefficiently all of the time, with increased flue and standby losses. This can be a particular problem where building envelope conservation measures have greatly reduced the heating requirements. The firing rate can be reduced by adjusting the fuel/air mixture and reducing the fuel orifice or nozzle size to reduce the overall fuel volume.

Since the base case for this measure is not consistent with the base building models, it has not been quantified. It would be very difficult to establish any kind of 'representative' degree of heating plant oversize. A general calculation method is suggested on the algorithm sheet.

#### HVAC-23 INSTALL MULTIFUEL/SOLID FUEL BOILER

Heating costs can be reduced by installing a multifuel or solid fuel boiler in areas having abundant and economical local supplies of solid fuel (wood or coal). This measure is not quantified, since it is a potential

cost-saving measure only, not an energy-saving measure. Also, any calculation would require a single set of assumptions about the cost of providing heating with solid fuel, which can vary widely with the type of equipment and the cost, heating value, and local availability of the solid fuel. A general method for determining cost savings is suggested on the algorithm sheet.

#### HVAC-24 INSTALL HOUSE FAN(S)

Install an exhaust fan in the attic or other appropriate location to substitute for mechanical cooling when outdoor conditions are appropriate particularly at night. This measure is considered applicable only to single-family buildings, P/U type 1. House fans can be very effective in reducing energy requirements for cooling, particularly when a flushing with cool night air is used to reduce a day's heat buildup. However, the measure is not quantified due to its limited applicability, and since the savings are highly dependent on behavioral factors governing the degree of use, which would be impossible to predict for a "representative" cases. A calculation method is suggested on the algorithm sheet.

#### HVAC-25 CONDENSER COIL SPRAY

A system is installed to spray water on the coils of an air-cooled condenser lowering the condensing temperature and increasing the equipment's Coefficient of Performance. This measure was not quantified, as adequate data concerning system costs and savings potential was not available. Savings are produced in a way similar to HVAC-16, water-cooled condenser, but would tend to be of lower magnitude.

#### HVAC-26 CHILLER BYPASS SYSTEM

This measure is applicable to buildings with a central cooling system using a watercooled condenser and a cooling tower. An automatic control system is installed to circulate chilled water directly through the cooling tower, bypassing the chiller, when outdoor wet-bulb temperatures are low enough to produce adequate cooling by this method. It is usually necessary to install a special strainer in the water line to avoid contaminating the chiller with particulate matter picked up in the cooling tower.

In calculating savings for this measure, it was found that outdoor wet-bulb temperatures are always too high to produce effective results during the normal cooling season. This measure is most practical in commercial buildings with internal zones that may require cooling during the normal heating season, and where transfer of heat from interior to exterior zones is either impossible or the potential has already been exhausted. However, since the base building models do not include modeling of zone-by-zone conditioning needs, it was not possible to quantify this measure.

#### DHW-1 INSTALL SUMMER DHW BOILER

Where domestic hot water is generated by a tankless coil in the main heating boiler, the boiler must be run throughout the non-heating season just to maintain the DHW supply. Usually this involves running the boiler at a small fraction of its capacity, and hence at a low efficiency. Energy is saved by installing a separate direct-fired domestic hot water boiler to operate in the summer only.

This measure is modeled for the small and large multifamily types (P/U 2, 5) with water systems. The applicability to single-family homes (P/U 1) would be very limited, as most homes would already have a separate DHW heater rather than a tankless coil. It is also not modeled for the commercial types (P/U 3, 4), as it assumed the commercial buildings using a tankless coil would not supply domestic hot water during the non-heating season.

It should be noted that the base case for this measure differs from the building model used to generate the base load profiles, in that the model assumes use of a separate DHW heater in all cases. However, the savings calculated for this measure are applicable to buildings having a tankless coil system.

#### DHW-2 INSTALL FLOW CONTROL DEVICES

Most faucets and shower heads are inefficiently designed, such that the volume of water used is much greater than necessary. Flow control devices use the available water pressure more efficiently to create better dispersion of the water and a higher apparent pressure, such that less water is used. Flow control shower heads and faucet aerators save energy by reducing domestic hot water use by over 50%.

In modeling this measure, it is assumed that 60% of residential DHW use is for showers. The remaining 40% covers all other uses, such as handwashing, dishwashing, house cleaning, laundry, etc. It is also assumed that shower flows are reduced from 6 gallons per minute (GPM) to 3 GPM, and typical faucet flows from 2.5 GPM to 0.5 GPM. These reductions are typical of actual devices on the market, but there could be considerable variation from one device to another. The savings for this measure are also highly dependent on behavioral factors, and must therefore be interpreted as representing a point in a broad range, rather than an exact estimate.

#### DHW-3 INSULATE DHW STORAGE TANK

Substantial losses occur from uninsulated or poorly insulated domestic hot water storage tanks. Insulation of 1 1/2 inch thickness is installed over the tank. For the single-family type (P/U 1), the base case assumes a conventional upright DHW heater with a thin layer (about 1/2 inch) of original built-in insulation, and the measure consists of fitting an insulation blanket, of the type commercially available for that purpose,

over the heater. For all other building types, the base case assumes a separate steel storage tank, uninsulated, sized to meet 2 hours of peak DHW demand; the measure consists of insulating the surface with insulation of the type used for boiler jackets.

Savings are calculated on the basis of reduced energy loss from the DHW system, but also take into account the increase in heating load and decrease in cooling load effected by the reduction of heat given off by the tank. It is assumed that 50% of the tank's heat loss had contributed to the heating load, and that the remaining 50% had been lost from the building in the base case.

#### DHW-4 INSTALL VENT DAMPER ON DHW HEATER

An electrically-actuated automatic vent damper is installed on the domestic hot water heater to reduce off-cycle losses. Savings are based on oil-fired equipment. This measure is not applicable to buildings using a tankless coil for DHW.

The description of heating plant vent dampers given for measure HVAC-3 would apply here as well.

#### DEW-5 HEAT PUMP FOR DOMESTIC HOT WATER

An electric air-to-water heat pump is installed to replace existing domestic hot water heater. This measure is considered applicable only to residential buildings with a high year-round demand for domestic hot water. For air and water system, the base case assumes an existing oil-fired separate DEW heater. For decentralized systems, the base case is a separate electric DHW heater.

It is assumed that the heat pump would be installed in the building's basement or a similar utility area, and that indoor air from that area would be the heat source for the domestic hot water. While there *may* be some variation in basement temperatures between the different climate zones, an average basement temperature of 65° was assumed for all zones. The savings in warm climates may be slightly higher, and the savings in cold climates slightly lower, than those calculated. While this device would have some impact on the building's *overall* heating and cooling loads, this impact was difficult to predict and was omitted from the calculations. The extraction of heat from the basement would tend to slightly increase the heating load and decrease the cooling load, and would have a somewhat greater impact on low-rise buildings (where a greater proportion of the conditioned space is adjacent to the basement) than on high-rise buildings.

Air-to-water heat pumps are not yet a common item, and information on equipment performance and cost was difficult to obtain. Therefore, considerable variations in both calculated savings and the cost/savings ratio are possible, and the calculation should be interpreted as an

order-of -magnitude estimate.

#### DHW-6 REFRIGERATION HEAT RECLAIM FOR DHW

Install a special heat exchanger on the condenser side of the central cooling system to extract condenser heat for heating domestic hot water. This measure produces energy savings in two ways: by utilizing waste heat, the load on the primary DHW system is reduced or eliminated during the cooling season; by extracting heat from the condenser of the cooling system, the condensing temperature is lowered, which raises the cooling system's efficiency and further reduces energy use.

It was not feasible to quantify this measure, due to a lack of adequate data on the effectiveness and cost of heat reclaim systems. Where the base case is a direct-fired DHW system and a cooling system with an air-cooled condenser, the savings would be roughly equivalent to the savings for measure HVAC-16 (Replace Air-Cooled Condenser with Water-Cooled), plus the fuel energy equivalent of the reclaimed heat, determined at the seasonal efficiency of the DHW equipment. Where a water-cooled condenser already existed, savings would be somewhat reduced in that case.

#### L-1 REPLACE INCANDESCENT LIGHTING WITH FLUORESCENT

The base case assumes incandescent lighting in all locations for all building types. Fluorescent lamps are at least 3 times as efficient as incandescent in converting energy to light, and have a greater service life. Existing incandescent fixtures are removed and replaced with recessed fluorescent fixtures providing the same level of illumination. For the commercial building types (P/U 3 and 4), all lighting is replaced. For the residential types (P/U 2 and 5), lighting is replaced in corridors and entry areas, but incandescent lighting is retained in dwelling units for aesthetic reasons. This measure is considered inapplicable to single-family homes.

In evaluating this measure, only the savings in energy are considered. Changes in long-term lamp replacement costs owing to the longer service life of fluorescent lamps are not considered. The cost of this measure is calculated on the basis of the cost of new fixtures, installed, plus the cost of removing old fixtures. While a typical cost for recessed two-lamp fluorescent fixtures was used, there may be considerable variations in actual fixture costs.

#### L-2 INSTALL FLUORESCENT HYBRID LAMPS

where replacement of incandescent fixtures is not desired, fluorescent hybrid lamps can be installed in existing incandescent fixtures. The base case is the same as for L-1. Fluorescent hybrid lamps are typically circular tubes with a central element that screws into a conventional incandescent socket. It was assumed that this type of lamp would be

suitable for general commercial and corridor-lighting applications? but would be of limited applicability for domestic residential use. Therefore, savings are calculated on the assumption that hybrid lamps are used in all fixtures in commercial buildings and for all corridor lighting in multifamily types 2 and 5. For the single-family types and for dwelling units in the multifamily types, it is assumed that hybrid lamps replace 70% of the incandescent lighting. Obviously, this introduces an element of uncertainty into the cost-effectiveness for residential application, as the actual proportion of use could vary widely.

The expected service life of hybrid lamps is much longer than that of incandescent; however, this is not included in the cost calculations.

#### L-3 USE LOW WATTAGE TASK LIGHTING

Work areas in commercial buildings often have very high levels of general illumination to provide adequate lighting at work stations, which may in fact occupy only a small proportion of the total floor area. This is particularly true of large open office areas with high ceilings. Lighting energy can be saved by providing low-wattage task lighting at work stations, and reducing the general overhead lighting level to a "general purpose" level. In calculated savings, it is assumed that the level of illumination in work areas is reduced from 100 to 20 footcandles (the level suitable for corridors and passage areas). 75% of the total work area (non-corridor and service area) is affected by the measure, and 40-watt fluorescent task light fixtures are provided for 85% of the buildings occupant's. It was necessary to make these assumptions, as it is unlikely that a task lighting measure would be applicable to all of the work areas in a commercial building, or that all of the occupants would require task fixtures. The proportion of occupants requiring fixtures is higher than the proportion of floor area affected on the assumption that this measure would be most applicable to high-density work areas rather than private offices. The calculated cost-effectiveness of this measure should be evaluated in light of the assumptions made.

#### L-4 USE HIGH-EFFICIENCY FLUORESCENT LAMPS

In commercial buildings where fluorescent lighting already exists, standard 40-watt lamps are replaced with 32-35 watt high-efficiency lamps, which produce about the same level of illumination. All lamps in the building are replaced.

While this measure has been quantified for the sake of comparison, it assumes a base case of fluorescent lighting, which is different from the incandescent base case used in the load profiles and for all other lighting measures. Therefore, it is not included in the overall measure packages. Also, the assumption that all lamps would be simultaneously replaced is somewhat unrealistic; the more common procedure would be for the building operator to maintain a stock of high-efficiency lamps, and replace the



conventional lamps on a one-by-one basis as they burn out.

#### L-5 MAXIMIZE USE OF DAYLIGHTING

Install "light shelves," reflective ceiling panels, outdoor reflective panels, etc., to maximize availability of daylight as a substitute for electric lighting in commercial applications. This measure cannot be quantified on a general basis for several reasons:

1. The measure itself is not adequately defined; different types of devices would be applicable to different locations, and information on daylighting effectiveness devices is generally limited and difficult to find.
2. The effectiveness is highly site-specific, depending on the exact configuration of existing windows and on the presence of shading from other buildings? trees, etc.
- 3\* The cost and effectiveness both depend not only on the type of daylighting device used, but also on the control systems used to switch between daylighting and electric lighting, and on behavioral factors.

#### R-1 INSTALL SOLAR DOMESTIC HOT WATER

Flatplate collectors are installed to replace a portion of the domestic hot water demand. It is assumed, for all climates, that a southerly orientation is available, although recent studies have shown that orientations 90° from south (due east or west) provide from 83% (for Boston) to 94% (in Miami of optimal collection ("collector Location: No Taboos on East or West," Winslow Fuller, Solar Age, December 1980). Tilt is assumed to equal latitude. Single glazing is assumed for all climates.

This measure is not modeled in commercial buildings, since conservation efforts have eliminated use of hot water in many buildings surveyed. Systems are sized for approximately 50% solar contribution. Maintenance costs are assumed to be included in system costs.

#### R-2 INSTALL COMBINED SOLAR ACTIVE SPACE AND DOMESTIC HOT WATER SYSTEM

Flat plate collectors are installed to reduce fossil fuel consumption for space and domestic hot water heating. Southern orientation is assumed (see note above), with tilt equal to latitude plus ten degrees. Single glazing is assumed for all climates. Buildings with high internal gains and large forced ventilation losses are poorly modeled by correlation methods, so the two commercial types are omitted.

Systems were not iteratively optimized, nor was the standard F chart economic analysis employed. Systems are sized to provide about 25 - 30% of

total space and domestic hot water loads.

### R-3 INSTALL SUNSPACE

An attached greenhouse is installed to supply heat during the heating season. The sunspace is 30 feet long, 9 feet high at the attached wall, has a single south glazing tilted at 50°, and a 4 foot deep ceiling insulated to R-20. End walls are also insulated to R-20, night insulation of R-9 is provided and in place from 5:00 p.m. to 8:00 a.m. Sunspace temperatures are allowed to fluctuate between 45°F and 95°F.

The sunspace is only modeled for the first residential case, and savings do not include vegetable production or other benefits, such as added property value, aesthetics or increased living space.

### R-4 GLAZE MASONRY WALL

South-facing masonry walls adjacent to conditioned space can be used to collect and store the sun's energy when painted an absorptive color and covered with a suitable glazing to minimize heat loss. Using a design developed and popularized by Felix Trombe, performance estimates are calculated for residential buildings with south-facing, solid masonry walls. The walls are assumed to have thermocirculation vents at the top and bottom, each with areas equal to 3% of the total wall areas. Dampers to prevent nighttime backdraft losses are also assumed. No fan usage is assumed; heat transfer occurs passively through the thermocirculation vents and through the masonry wall. No night insulation is assumed; providing night insulation would improve performance significantly.

### R-5 ADD WALL PANEL, WITHOUT STORAGE

Where masonry wall do not exist, metal panels painted black and covered with glazing can be attached to the south wall and used to collect solar energy. Heat distribution occurs through ventilation openings cut in the wall allowing heated air to rise in the space between the metal absorber plate and the glazing and flow into the room. Panels are sized to avoid overheating, since there is no provision for storage. While thermosiphoning air panels have a lower efficiency than active collectors? they do not require fans, pumps, blowers, or control circuitry reducing their costs.

### R-6 ADD GLAZING, WITHOUT STORAGE

Allowing more sunlight to pass into the space increases winter heat gains and reduces overall heating load. Replacing opaque walls with transparent glazing and moveable insulation (to reduce night losses) saves energy.

Night insulation of R-9 is assumed to be in place from 5:00 p.m. to 7:00

a.m. No added storage is assumed, so the increase in solar aperture is limited to avoid overheating problems. It is assumed that summer sun is excluded to avoid increasing cooling loads.

Problems that may arise in residential building when direct gain aperture is increased include: loss of privacy, glare, and fading of fabrics. These considerations, as well as the benefits of increased glazing (better view, more natural lighting) have not been evaluated.

#### R-7 ADD GLAZING, WITH STORAGE

This measure is similar to the previous one in that it increases the solar aperture to allow for direct solar gain. The difference arises in the fact that since the aperture increases are larger, heat storage must be provided in the form of additional thermal mass. It is assumed that water containers are added, a volume of approximately .72 cubic feet per square foot of glazing, or approximately five gallons. In this case, it is assumed that no night insulation is used; the additional cost required and the additional space (beyond that which is occupied by the water stores) are assumed to be unavailable) .

Solar savings fractions obtainable with additional storage are higher than for direct gain without storage, but a diminishing cost-effectiveness.

# Appendix D

## Sources for Cost Estimates and Formulas for Estimating Savings

---

This appendix shows for each retrofit, the sources used by Energyworks in estimating the costs and savings for that retrofit.

### Sources for Costs and Savings Calculations

| <b>Envelope retrofits</b>     | <b>Retrofit costs</b>   | <b>Retrofit savings*</b>   |
|-------------------------------|---|--|
| E1. Roof insulation           | R. S. Means, <i>Building Construction Cost Data</i> , 1980                | Carrier System <i>Design Manual</i> —Load estimating (ref. 8)                          |
| E2. Wall insulation           | Same source as E1   | Same source as E1  |
| E3. Storm windows             | Same source as E1   | Same source as E1  |
| E4. Double glazing            | Same source as E1   | Same source as E1  |
| E5. weatherstripping          | Zero Weatherstripping Co.,<br>Bronx, N.Y.                                 | Same source as E1  |
| E6. Window insulation         | Appropriate Technology Corp.,<br>Brattleboro, Vt. (Window Quilt)          | Same source as E1 and manufacturers' information                                       |
| E7. Reflective films          | 3M Energy Control Products<br>Division, St. Paul, Minn.                   | Manufacturers' information   |
| E8. Shading devices           | Literature from several different products                                | Same source as E1  |
| E9. Roof sprays               | R. S. Means, <i>Buildings Construction Data</i> , sprinkler costs         | Same source as E1  |
| <b>HVAC retrofits</b>         |   |  |
| H1. Replace burner            | ABC Sunray Corp., Plainview, N.J.   | Brookhaven, <i>Efficiency of Residential Oil-Fired Boilers</i> (ref. 7)                |
| H2. Replace boiler            | Hydrotherm, Inc., Northvale, N.J.   | Same source as H1  |
| H3. Vent damper               | Flair Manufacturing Corp.,<br>Hauppauge, N.Y.                             | Same source as H1  |
| H4. Stack heat reclaimer      | Condensing Heat Exchanger Corp.,<br>Latham, N.Y.                          | Same source as H1 plus Brookhaven reports on boiler stack economizers (refs. 9 and 10) |
| H5. Heat pumps                | R. S. Means, <i>Mechanical and Electrical Cost Data</i> , 1980            | Residential Conservation Service, <i>Mode/Audit Manual</i> (ref. 18)                   |
| H6. Boiler turbolators        | Fuel Efficiency, Inc. (Brock<br><i>Turbolator</i> ) Newark, N.J.          | Same source as H1  |
| H7. Modulating aquastat       | American Stabilis, Inc. ( <i>Enertrol</i> )<br>Lewiston, Maine            | Hydronics Institute— <i>Controls for Hydronic Systems</i> (ref. 14)                    |
| H8. Setback thermostats       | R. S. Means, <i>Mechanical Data</i>                                       | Carrier, <i>Systems Design Manual</i> (ref. 8)   |
| H9. Economizer                | Honeywell enthalpy control package  | Honeywell, <i>Energy Conservation With Comfort</i> (source for algorithm)              |
| H10. Room air-conditioners    | R. S. Means, <i>Mechanical Data</i>                                       | RCS, <i>Manual</i> (ref. 18)   |
| H11. Central air-conditioners | R. S. Means, <i>Mechanical Data</i>                                       | RCS, <i>Manual</i> (ref. 18)   |
| H12. Vary chilled water       | Controlled Energy Systems Co.,<br>Seattle, Wash.                          | FEA, ECM-2 (ref. 12)   |
| H13. Reheat to VAV            | R. S. Means, <i>Mechanical Data</i>                                       | Honeywell (ref. 13), Hydronics Institute (ref. 14)                                     |
| H14. Reduce ventilation       | Honeywell, Minneapolis, Minn.<br>( <i>Tradeline</i> , low leakage damper) | Weather service climate data   |
| H15. Evaporative cooling      | R. S. Means   | ASHRAE <b>Handbook 1976 (ref. 5)</b>   |
| H16. Water-cooled condenser   | R. S. Means   | FEA, ECM-2 (ref. 12)   |
| H17. Fog cooling              | Carrier Corp. (Rota Spray) sprayed coil system                            | ASHRAE Handbook 1976, 1977 (refs. 4 and 5)   |
| H18. Insulate ducts           | R. S. Means   | FEA, ECM-2 (ref. 12)   |

| <b>HVAC retrofits</b>            | <b>Retrofit costs</b>  | <b>Retrofit savings*</b>  |
|----------------------------------|--|---|
| H19. Insulate pipes              | R. S. Means  | FEA, ECM-2 (ref. 12)  |
| H20. Two-speed fans              | Carrier Corp. (Mocludrive)   | FEA, ECM-2 (ref. 12)  |
| <b>Hot water retrofits</b>       |  |   |
| D1. Summer hot water heater      | R. S. Means  | Brookhaven boiler analysis (ref. 7)   |
| D2. Flow controls                | Omni Products, Inc., Yucca Valley, Calif.  | ASHRAE Handbook (refs. 4 and 5)   |
| D3. Insulate storage             | R. S. Means  | Carrier Corp., <i>System Design Manual</i> (ref. 8)   |
| D4. Vent damper                  | Same source as H3  | Brookhaven (ref. 7), NBS energy conservation modifications for water heaters  |
| D5. Heat pump water heater       | E-Tech., Inc., Atlanta, Ga.  | Department of Energy, research and development of heat pump water heater (ref. 11)  |
| <b>Lighting retrofits</b>        |  |   |
| L1. Fluorescent for incandescent | R. S. Means  | McGuinness and Stein (ref. 15)  |
| L2. Hybrid fluorescent           | GE, Circlight, Los Angeles, Calif.   | McGuinness and Stein (ref. 15)  |
| L3. Task lighting                | Dayton Co., commercial work fixtures   | McGuinness and Stein (ref. 15)  |
| L4. High-efficiency fluorescent  | GE ( <i>Watt Miser II</i> ), Sylvania (Superstar)  | McGuinness and Stein (ref. 15)  |
| <b>Solar retrofits</b>           | References for Costs, local contractors in Massachusetts cross-checked with R. S. Means, <i>Cost-Study Report to Mass-Save, Inc., 1981</i> | <i>References for Savings, 1) Solar Heating Design by the F-Chart Method, Beckman, Klein, Duffie, 1977, and 2) Passive Solar Design Handbook, vols. 1 and 2</i> |

● Most of the algorithms used to estimate energy savings were developed by Energyworks, Inc. of West Newton, Mass., using parameters to be found in the sources cited. In a few cases, indicated here, the algorithm came from the source

## List of References

1. **A Guide to Assessing Energy and Cost Saving Opportunities in Institutional Buildings, vol. 2, U.S. Department of Energy, 1979.**
2. **AIA Research Corp., Phase One/Base Data for Energy Performance Standards for New Buildings, U.S. Department of Housing and Urban Development, 1978.**
3. **Arthur D. Little, Inc., Potential for Energy Technologies in Residential and Commercial Buildings.**
4. **ASHRAE Handbook and Product Directory, 1977 Fundamentals, American Society of Heating, Refrigerating, and Air Conditioning Engineers.**
5. **ASHRAE Handbook and Product Directory, 1976 Systems, American Society of Heating, Refrigerating, and Air Conditioning Engineers.**
6. **Brisbane, T. E., et al., Energy Saving Devices on Gas Furnaces, National Technical Information Service, AD-A082 075, 1980.**
7. **Brookhaven National Labs, Direct Measurement of the Overall Efficiency and Annual Fuel Consumption of Residential/ Oil-Fired Boilers, BNL No. 50853, 1978.**
8. **Carrier Air Conditioning Co., System Design Manual, 1960.**
  - a. Vol. I—Load Estimating
  - b. Vol. n—Air Distribution
  - c. Vol. III—Piping Design
  - d. Vol. X—All-Air Systems
9. **Efficiency Test Report for Therma-Stak Boiler Economizer, Brookhaven National Laboratory, 1978-79.**
10. **Efficiency Test Report Boiler Stack Economizer (Maxi Heat), Brookhaven National Laboratory, 1978-79.**
11. **Energy Utilization Systems, Inc., Research and Development of a Heat-Pump Water Heater, U.S. Department of Energy, ORNL/Sub.-7321/I.**
12. **Federal Energy Administration, Guidelines for Saving Energy in Existing Buildings—ECM-2, 1975.**
13. **Honeywell Corp., Energy Conservation With Comfort.**

14. **Hydronics Institute, Technical Topics # 3—Controls for Zoned Hydronic Systems.**
15. **McGuiness and Stein, Mechanical and Electrical Equipment for Buildings, John Wiley & Sons, Inc., 1971.**
16. **Palla, Robert L., Evolution of Energy-Conserving Modifications for Water Heaters, National Bureau of Standards, 1979.**
17. **P/S Energy Services, Inc., Summary of Capital Modifications (Based on data from grant applications submitted under Cycle II of the Schools and Hospitals grants program).**
18. **Residential Conservation Service, Model Audit Manual, U.S. Department of Energy, 1980.**
19. **Trane Air Conditioning Co., Product Literature No. DS S/S-2/February 1980.**
20. **U.S. Departments of the Air Force, the Army, and the Navy, Engineering Weather Data, 1978.**
21. **U.S. Department of Commerce, Comparative Climate Data for the United States Through 1979.**
22. **U.S. Department of Energy, Energy Performance Standards for New Buildings: proposed Rule, 1979.**
23. **U.S. Department of Energy, Climate Classification Analysis, 1979 (Technical Support Document for No. 19.)**

O