

Arming Our Allies: Cooperation and Competition in Defense Technology

May 1990

OTA-ISC-449

NTIS order #PB90-254160



OFFICE OF TECHNOLOGY ASSESSMENT
CONGRESS OF THE UNITED STATES

Recommended Citation:

U.S. Congress, Office of Technology Assessment, *Arming Our Allies: Cooperation and Competition in Defense Technology OTA-ISC-449* (Washington, DC: U.S. Government Printing Office, May 1990).

For sale by the Superintendent of Documents
U.S. Government Printing Office, Washington, DC 20402-9325
(order form can be found in the back of this report)

Foreword

Cooperating with our allies in the supply and joint production of defense technology has been an important element of U.S. national security policy and a cornerstone in alliance relations for the past 40 years. As the undisputed technological leader of the Free World in the post-WWII period, the United States transferred military technology to its allies in Europe, Asia, and the Middle East to help them rebuild their industries and defend against the military threat from the Soviet Union and its allies.

The success of this decades old policy has led to many economic and political changes. Consequently, Congress and the Administration are re-evaluating the nature of the military threat in light of the failure of communism in Eastern Europe, deepening detente in U.S.-Soviet relations, decreasing defense budgets, and escalating competition with our allies in both military and commercial technologies.

This review comes at a time when the United States has lost its monopoly advantage in the development and production of sophisticated defense systems. Three centers of rough technological and economic parity now dominate the globe—the United States, the European Community, and Japan. As a result, overcapacity and real competition for shrinking defense markets among the different national and regional defense industries has become evident.

At the request of the Senate Committee on Armed Services and the House Committee on Government Operations, OTA undertook an assessment of international collaboration in defense technology. This Special Report is the first product of that assessment. It provides an overview of the subject and analyzes the impact that changes in the environment of defense technology and reduced East-West tensions will exert on defense industrial cooperation and associated alliance relations.

JOHN H. GIBBONS
Director

International Collaboration in Defense Technology Advisory Panel

John S. Toll, *Chairman*
President
Universities Research Association, Inc.

David M. Abshire
President
Center for Strategic and International Studies

Andrew Pierre
Senior Associate
Carnegie Endowment for International Peace

Morton Bahr
President
Communications Workers of America

Raymond C. Preston
Vice President Washington Operations
Williams International

Michael Bonsignore
President
Honeywell International

Clyde V. Prestowitz
President
Economic Strategy Institute

Robert B. Costello
Senior Fellow
Hudson Institute

John D. Rittenhouse
Senior Vice President
General Electric Aerospace

Jacques S. Gansler
Senior Vice President
The Analytic Sciences Corp.

Richard Samuels
Professor
Department of Political Science
Massachusetts Institute of Technology

Everett D. Greinke
Consultant

James A. Tegnalia
Vice President
Martin Marietta Electronics

Ryusuke Hasegawa
Director of Far East Affairs
Allied Signal Corp.

Richard E. Tierney
President
SLI Avionic Systems

Robert J. Herman
Vice President
United Technologies Corp.

Raymond Vernon
Professor
J.F. Kennedy School of Government
Harvard University

Robert D. Hormats
Vice Chairman
Goldman Sachs International

Dale S. Warren
Vice President & Deputy General Manager
Douglas Aircraft co.

Francine Lamoriello
Manager of International Trade
KPMG Peat Marwick Co.

Robert G. Lunn
Vice President
Science Applications International Corp.

NOTE: OTA appreciates and is grateful for the valuable assistance and thoughtful critiques provided by the advisory panel members. The panel does not, however, necessarily approve, disapprove, or endorse this report. OTA assumes full responsibility for the report and the accuracy of its contents.

International Collaboration in Defense Technology OTA Project Staff

Lionel S. Johns, *Assistant Director, OTA
Energy, Materials, and International Security Division*

Alan Shaw, *International Security and Commerce Program Manager*

William **W. Keller**, *Project Director*

Gordon Law

Todd M. La Porte

Peter H. Rose*

Congressional Research Service Contributors

Larry A. Niksch

John Moteff

Administrative Staff

Jackie Robinson

Louise Staley

Donna Reynolds

Contractors

P. Robert Calaway

Michael W. Chinworth**

Allen Greenberg

*AAAS Fellow, 1989-90.

**MIT/Japan Science and Technology Program.

Workshop on Transatlantic Cooperation in Defense Technology— European Perspectives

Alan Shaw, *Chair*
Program Manager, International Security and Commerce Program
Office of Technology Assessment

Peter A. S. Boxer
Senior Vice President
British Aerospace

Richard Brackeen
CEO and President
Matra Aerospace, Inc.

David C. Elliott
Vice President
Plessey Electronic Systems, Inc.

William Heinz
Vice President
Dowty Electronic Systems Division

B. P. (Paul) van Ysselstein
Vice President Defense Affairs
Fokker Aircraft USA, Inc.

Mario Locatelli
President
FIAT, Washington, Inc.

Barry New
Vice President-Government Programs
Rolls Royce

Peter H. Orvis
Special Assistant to the President
Hollandse Signaalapparaten B.V.

Enrico Striano
President and CEO
Agusta Aerospace Co.

Manfred von Nordheim
President
MBB of America, Inc.

NOTE: OTA appreciates and is grateful for the valuable assistance and thoughtful critiques provided by the participants in the workshop. The workshop participants do not, however, necessarily approve, disapprove, or endorse this report. OTA assumes full responsibility for the report and the accuracy of its contents.

CONTENTS

	<i>Page</i>
Overview and Principal Findings	3
Chapter I: Interdependence in Defense Technology	9
Chapter 2: Implications and Issues for Congress	21
Chapter 3: European Policies in Perspective	41
Chapter 4: Emergence of Transpacific Collaboration: The Case of Japan	61
Chapter 5: Commercial Implications of International Collaboration	77
Appendix A: Organizational Structures for Cooperation	89
Appendix B: Techniques and Mechanisms for Cooperation	96
Appendix C: Japanese Defense Policymaking and Industry	102
Appendix D: South Korea: Goals and Strategy for Building Defense Industries	111

Overview and Principal Findings

Overview and Principal Findings

The established order of the Cold War period is being rapidly supplanted by new security and economic relations. There is much uncertainty regarding the future of NATO and the Warsaw Treaty Organization, the evolving political systems of Eastern Europe, internal political and nationalist struggles in the Soviet Union, German reunification, economic integration of Western Europe, and future superpower relations. What is certain is that **the reasons the United States collaborated with its allies in defense technology are not as valid as they once were, and U.S. policies on armaments cooperation, broadly conceived, must be reconsidered.**

The principal reason the United States transferred military technology to its allies, both in Europe and in Asia, was to build up their defense industries and military capacity for mutual defense against the Soviet Union and other communist powers. That policy succeeded. In the space of a few decades it contributed to the development of sophisticated centers of defense technology across Western Europe and in the Western Pacific. **The policy also led to significant peacetime overcapacity in the defense industries worldwide, and to intense international competition for sales of high-technology weapons.**

Superiority in military technology over potential adversaries has been the explicit foundation of U.S. national security policy for 40 years. Technological leadership over our allies has been implicit in that policy. That superiority is declining, in part because of our own efforts to assist our allies. **The loss of technological supremacy may be an unavoidable long-term cost of maintaining strong security alliances. It might also be the price of gaining access to foreign defense technology in the future.** Cooperation in defense technology is accelerating this process, and helping to undermine the

U.S. national security posture of designing and fielding defense systems at least a generation ahead of the competition. **However, the changing nature of the military threat makes this an appropriate time to reevaluate our basic national security strategies and goals.** Because the threat is changing, the character of our alliances is likely to change as well.

If tensions associated with trade and technology competition between the United States and Japan continue to escalate, **the traditional separation between economic affairs and the U.S.-Japan security relationship probably cannot be maintained.** This became evident in the controversy over the transfer of F-16 fighter technology to assist Japan in building its new fighter aircraft, the FSX. For the first time, military and trade issues were intertwined in an open, and sometimes acrimonious, public debate. It became clear in the course of this debate that the U.S. Government lacks a coordinated policy or institutional mechanism by which to address specific cases like the FSX, or to resolve general questions arising from armaments collaboration with its allies. The issue remains unresolved, and **it is probable that the FSX controversy will be revisited the next time a major codevelopment program is proposed with an ally.**

In Europe, maintaining cohesion within the NATO Alliance has always been a balancing act, even in the face of a common threat from the East. Achieving rationalization, standardization, and interoperability of Allied weapons has proved to be an elusive goal. Armaments cooperation among the NATO Allies should have political benefits as well, but as the Nunn amendment programs have demonstrated, involving many governments in codevelopment lowers the odds of a successful outcome. **As the perception of the Soviet threat to Western**

¹The Nunn-Roth-Warner amendment to the FY 1986 Defense Authorization Act authorized funding for NATO cooperative R&D programs, and has received an appropriation each fiscal year as follows: FY86, \$100 million; FY87, \$145 million; FY88, \$150 million; and ~->\$117 million. The results have been uneven, however, due to the difficulty in harmonizing military requirements and to the multiplication of regulation and administration.

Europe diminishes, perhaps in consort with real conventional force (CFE) reductions now being negotiated in Vienna, the military, economic, and political interests of the United States and its European NATO Allies may diverge significantly.²

Such divergence will be exacerbated by increased competition between the U.S. and European defense industries for shrinking defense funding. U.S. defense exporters look to European markets as a safety valve against anticipated steep declines in the U.S. defense budget, and European firms seek to penetrate the U.S. defense market, which is still by far the largest and most lucrative in the world. **International collaboration among defense companies appears to be increasing at a time when transatlantic intergovernmental cooperation in defense technology has become increasingly problematic.** Interdependence for the best defense technology is fast becoming a fact of life.

Concurrently, competition between U.S. and European defense companies will escalate as they seek to export sophisticated weaponry to maintain revenues and keep production facilities open in a declining market. As U.S. influence over European sales to the Third World decreases, differences in the political and economic interests of the United States and its NATO Allies will become more important. **It is possible, for example, that the United States will need to project power into regions and against countries that have been armed by the Europeans.³** In that case, the United States will have to design its weapons systems against European standards, and the question of what defense technology is transferred to Europe will become crucial.⁴

But here, as elsewhere, the interests of the United States and its defense companies may differ in important respects. Large U.S. companies that can operate internationally are entering into strategic market alliances and other business arrangements with European and Asian firms, transferring U.S. technology and subcontracting with them for portions of U.S. weapons systems. **Although defense collaboration makes business sense for individual companies, it may ultimately create unacceptable dependence on foreign suppliers, erode parts of the U.S. defense industrial base, and undermine U.S. foreign policy goals such as non-proliferation of delivery vehicles for weapons of mass destructions**

To complicate matters, even though it does create interdependence, **international collaboration also gives DoD access to foreign defense technology that may be superior to that produced in the United States.** Extensive procurement from foreign suppliers, however, coupled with a failure to support U.S. sources, could damage domestic defense companies. But a policy that guaranteed domestic sourcing from particular companies (or for a specific technology) might, in time, degrade domestic capability because there would be no foreign competition and, therefore, less incentive to innovate and to make investments in R&D.

As defense industries restructure their operations in response to overcapacity and declining defense budgets, there will be a few winners and many losers. **The United States could end up with a defense industrial structure inadequate for the defense of the Nation.** It is also possible that the United States will not need anything approaching the level of defense industrial capacity that it has built up over the past

²If economic integration in Europe proceeds smoothly, even in the event of accelerated German reunification, increasing trade competition between the Europeans and the United States may introduce additional complexities into the NATO equation.

³Many advanced European weapons systems have incorporated technologies initially developed or codeveloped by U.S. defense companies.

⁴This problem was demonstrated in the Persian Gulf when the U.S.S. *Stark* was struck by two French-made Exocet missiles.

⁵"At least 16 Third World nations now possess ballistic missiles. . . . The United States has not transferred ballistic missiles to the Third World since 1974. The most recent and important source of missile technology for Third World missile programs is West European companies and individuals willing to sell technical and material assistance." U.S. Arms Control and Disarmament Agency, *World Military Expenditures and Arms Transfers 1988*, June 1989, p. 17.

three decades. **The challenge will be to convert the defense industries to an appropriate peacetime posture and still retain the capacity to mobilize in a crisis.**

Any proposed policy changes on international collaboration will have to be sensitive to the different kinds of companies that supply equipment to the Department of Defense. Large prime contractor companies that build and integrate whole systems generally see increased internationalization as a positive business trend. Some argue that international corporate alliances create access to new markets and superior technology, and will ultimately produce greater efficiencies by driving less competitive suppliers out of business. Smaller subcontracting companies that depend on DoD for most of their business worry about losing sales to foreign

competition and about resulting damage to the U.S. defense industrial base. International dual-use technology producers may decide not to do business with the Defense Department if the rules and regulations are sufficiently onerous.

This OTA Special Report identifies and analyzes the principal issues related to international collaboration in defense technology, and provides some policy discussion. As an interim report, it does not include detailed policy options for congressional consideration; these will be included in the final report of the project in May 1991. **Additional findings on defense industry and technology are presented at the end of chapter 1, and the principal issues are discussed at the end of chapter 2.** Chapters 3-5 and appendices A-D provide background and analysis on which the findings are based.

Chapter 1

**Interdependence in
Defense Technology**

CONTENTS

	<i>Page</i>
THE CONTEXT OF COLLABORATION	9
HISTORICAL PERSPECTIVE	13
ADDITIONAL FINDINGS-Defense Industry and Technology	15
united states	15
Western Europe	16
western Pacific	17

Figure

	<i>Page</i>
1-1. Defense Department Budget Authority, 1946-95-Estimated	11

Table

	<i>Page</i>
1-1. Forms of Collaboration in Defense Technologies	15

Interdependence in Defense Technology

THE CONTEXT OF COLLABORATION

In the spring of 1989, Congress decided to permit General Dynamics Corp. to transfer F-16 fighter aircraft technology to Japan as part of an agreement with Mitsubishi Heavy Industries (MHI) to build an advanced fighter, the FSX. This deal differed from previous military cooperation that transferred defense technology to Japan because—for the first time—it involved *joint* development and production of a large-scale weapons system, funded by the Japanese Government, and using a Japanese company as the prime contractor.¹ It is also different because it took place against a backdrop of trade and technology issues that continue to strain relations between the two economic superpowers.

The debate over the FSX divided the Bush Administration, with the Department of Defense (DoD) defending the deal against critics in Congress, the press, and the Department of Commerce. Commerce officials and others asserted that advanced technology transferred to Japan would ultimately be used to penetrate civilian aviation markets, posing a new competitive threat to the American aviation industry. They questioned whether the FSX agreement was in the national interest, and specifically what technologies or other benefits the United States would receive in return. Others observed that in recent years, at the urging of the U.S. Government, the Japanese defense budget has risen to over \$30 billion, making it roughly equal to those of the major European powers: the United Kingdom, West Germany, France, and Italy.² They also expressed concern that the approval to build the FSX might constitute a step toward the remilitarization of Japan.

The prospect of U.S.-Japanese collaboration on the FSX also caused dissension within Congress, between factions that emphasized cooperation with our allies on one side, and those that sought to protect the defense industrial base and the commercial aerospace industry on the other. The debate made international collaboration with Japan a major issue in Congress and subjected it to national media attention. The question of how much and what kinds of technology the United States should transfer—and to which allies—became politically charged.

In the absence of a comprehensive policy, it is likely that the controversy over the FSX will be revisited the next time DoD negotiates a major codevelopment project with Japan. Security and trade issues, which had long occupied independent zones, have collided and will now have to be considered within a single policy framework. The argument that the United States should transfer technology to increase Japan's military capability and to strengthen ties between the two nations has lost its force. It is likely that trade and security issues will be more tightly coupled in the future, and that continued success of the U.S.-Japan security relationship will depend increasingly on the ability of the two nations to reduce economic confrontation and resolve outstanding trade disputes.

But Japan is not the only point of friction. Even before the FSX debate, the issue of collaboration with our NATO Allies had become more salient. With U.S. encouragement, the Europeans have developed very effective intra-European defense cooperation and, for many years, have configured their policies and defense industries to support it. There is considerable speculation that the Independent Euro-

¹The United States had previously transferred numerous military systems to the Japanese, such as the P-3C anti-submarine aircraft, the F-15 fighter, and the Patriot missile system, but these systems were developed in the United States, and then licensed for production in Japan and in other allied nations.

²Japanese military spending is technology intensive. In 1987, for example, Japan's defense budget was the sixth largest in the world, but Japan did not rank in the top 20 in terms of number of persons in its military services. U.S. Arms Control and Disarmament Agency, *World Military Expenditures*, #131 (Washington, DC: U.S. Government Printing Office, June 1989), p. 3.

pean Programme Group, an organization of European defense ministers, will assume the role of negotiating defense collaboration with the United States on behalf of a united Europe.

Collaboration in defense technology is a major issue in the context of restructuring the defense industries in the United States, Europe, and Asia to meet future threats with far smaller defense budgets.³ The nature of the threat, the forces necessary to meet it, and the levels of defense funding are all uncertain. In these circumstances, it will be very difficult, both politically and economically, to retain the same defense industrial capacity (in the United States and in the NATO Alliance) that has been built up over the past four decades.

In the post-WWII period, the U.S. defense budget has averaged about \$270 billion a year in constant fiscal 1991 dollars. It has dipped as low as \$210 billion, following the Korean and Vietnam conflicts, thus establishing what might be termed a Cold War floor for defense expenditures (see figure 1-1).

The Reagan spend-up represented by far the largest peacetime budget increase in U.S. history. Many defense industry executives and analysts believe that the U.S. defense budget is now entering a period of free fall, similar to the post-Vietnam era of detente, with the difference that the Cold War has ended, and the perception of the Soviet threat in the public and among politicians is greatly reduced.

Much lower defense budgets will cause major changes and pains of adjustment for the defense industries around the world, particularly if such constraints are sustained into the foreseeable future. A comprehensive policy on international collaboration will be an integral part of deciding how to restructure the defense industries. A

sound policy would tell us how much defense industrial capacity to retain at home, how much to build in collaboration with our allies, how to allocate the burden of defense among the allied nations, and how to restructure the defense industries to do it.

Powerful factions within Congress have long expressed concern about the U.S. defense industries, particularly the second and lower tier defense contractors. Numerous statutes contain buy-American provisions, and an amendment to the Defense Production Act, proposed during the 101st Congress, would direct the President to limit within 5 years the production of existing and new weapons systems to domestic manufacturing and assembly sources. However, Congress continues to grant the Secretary of Defense authority to waive the Buy American Act, and has funded dozens of programs to stimulate R&D and possible codevelopment of new weapons with the NATO Allies under the Nunn amendment.⁴ Indeed, there is a long history of collaboration between the United States and its European Allies, including coproduction of the F-16 fighter airplane by four nations, and the NATO AWACS, to name two prominent examples.

Few disinterested observers take the position that the United States can still develop, effectively and efficiently, all of the technology needed to build modern weapons systems; that period of weapons self-sufficiency was over even before the war in Vietnam. Much weapons technology is dual-use, that is, produced both for civilian markets and for military applications. Much of it is developed by large multinational companies with manufacturing facilities around the world. Part of the problem is our need to accept the fact that the leading edge of

³The structure of the U.S. defense industries is analyzed in the following chapter.

⁴The Nunn-Roth-Warner amendment to the fiscal year 1986 Defense Authorization Act produced a budgetary commitment to NATO armaments cooperation for the first time, with \$100 million appropriated exclusively for NATO cooperative military R&D in fiscal year 1986, and an additional \$25 million appropriated for side-by-side testing of U.S. and Allied systems.

Figure I-I—Defense Department Budget Authority. 1946-95—Estimated
(in 1991 constant \$ billions)

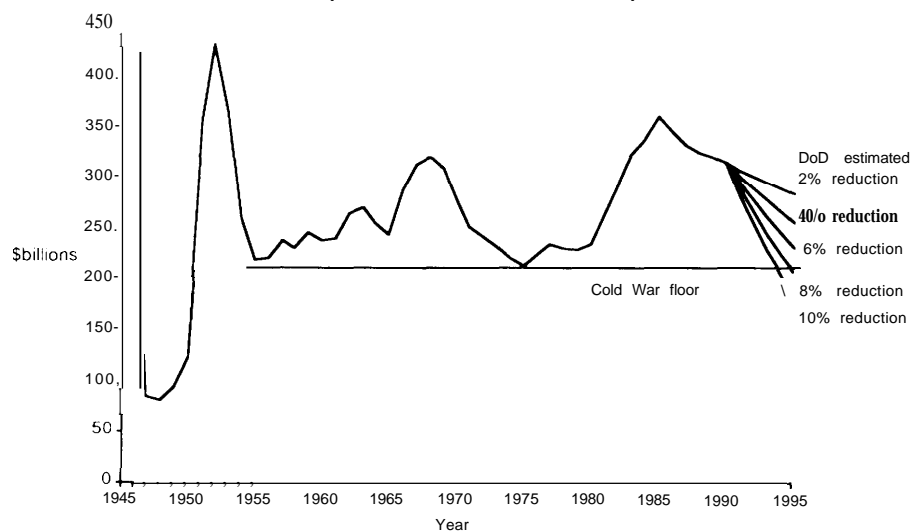

SOURCE: Department of Defense, and Office of Management and Budget, 1990.

technology does not always reside in the defense industries or even in the United States.⁵

Increasingly, internationalized patterns of industrial development are making irrelevant much of the debate over U.S. defense production. If DoD pursued a strict policy of procuring only from U.S. companies, it would be difficult to specify exactly what a U.S. company is. Would it be possible to find them in sufficient quantity and quality in the United States to sustain the defense industrial base?⁶ Would a foreign-owned company be considered non-U.S. for defense purposes, even if it conducted most of its R&D, manufacturing, and sales activity in the United States? A great deal of technology already flows into U.S. defense systems from Canada, which in addition to being a member of NATO, is part of the North American Defense Industrial Base, and is tightly integrated with the U.S. economy through free trade agreements.⁷ Many U.S. weapons systems

depend, partly by design and partly by chance, on Japanese and European technology, parts, and components. Interdependence in the defense industries is a fact of life and will continue to be in the 1990s and beyond.

Concurrently, the trend toward multilateral collaboration in defense technology has created what one analyst calls “class warfare” between the largest U.S. prime contractors and the thousands of smaller defense companies that depend on subcontracts from the primes to stay in business. The large aerospace and electronics defense companies, among others, favor policies that promote international collaboration, because it gives them the flexibility to team, subcontract, and form alliances with suppliers and partners around the world. This proliferates the number of different kinds of production arrangements that can be made, but more importantly, it increases access to foreign defense markets for the U.S. primes.

⁵See, for example, Defense Science Board, “Report of the Defense Science Board Task Force on Defense Semiconductor Dependency,” prepared for the Office of the Under Secretary of Defense for Acquisition, Washington, DC, February 1987; U.S. Congress, Office of Technology Assessment *Paying the Bill: Manufacturing and America's Trade Deficit*, OTA-ITE-390 (Washington DC: U.S. Government Printing Office, June 1988); and U.S. Congress, Office of Technology Assessment, *Making Things Better: Competing in Manufacturing*, OTA-ITE-443 (Washington DC: U.S. Government Printing Office, February 1990).

⁶OTA addressed these and related issues in U.S. Congress, Office of Technology Assessment, *Holding the Edge: Maintaining the Defense Technology Base*, OTA-ISC-420 (Washington, DC: U.S. Government Printing Office, April 1989).

⁷Canada is considered part of the U.S. defense industrial base for all but a few highly classified DoD programs. This cooperation dates back to the 1940s, and has recently been reaffirmed by both nations.

Most of the smaller American defense companies are more parochial in their concerns. They specialize in doing defense business in the United States, and generally do not have the requisite knowledge or resources to enter into international business arrangements. These companies fear loss of business when a large U.S. company agrees to let a foreign firm build a major subsystem or component for a U.S. weapon system, because the foreign firm is unlikely to do business with suppliers in the United States. In this view, if a subcontract is awarded to a European or Asian firm, it is a zero-sum game, a lost opportunity for a U.S. company that may be extremely damaging to that company's future. They argue, moreover, that giving defense business to foreign firms erodes the U.S. mobilization base.

Consequently, many smaller defense companies support legislation that would force DoD to spend defense dollars at home. They argue that industrial policies of other nations strengthen the hand of foreign competitors, creating unfair advantages through subsidies, tax incentives, and low-interest loans. Nevertheless, the interests of the smaller companies may not be promoted by protection from the forces of globalization. In the FSX example, Japan agreed to let General Dynamics (GD) do 40 percent of **development** of the new airplane, and some unspecified amount of production, even though the U.S. Government does not plan to buy it.⁸ GD is an obvious winner in the short term, but so are its U.S. subcontractors who will supply parts and components for the FSX fighters it produces. In this situation, GD acts as a conduit through which foreign work and money flows down into the U.S. defense industrial base.⁹

In the 1990s, some international collaboration in defense technology will be unavoidable and probably desirable. Ultimately, Congress will have to decide how much interdependence in defense technology and industry is prudent and

supportable; which allies should be favored and to what extent; what the United States should expect or demand in return for its technology; how best to support domestic development of critical technologies; and what kind of domestic defense industrial structure must be maintained to meet the future security needs of the United States. Having such decisions to DoD, to the defense industry, to chance, or to the vagaries of international defense markets could place the Nation's security at risk with catastrophic consequences. Moreover, congressional approaches that place constituency interests ahead of the national interest are potentially dangerous, as the Nation confronts dynamic new relationships in economic, political, and strategic security around the world.

Whatever the final policy determinations are, they will be taken against the backdrop of astonishing political upheaval in Eastern Europe and changes in the relationship between the United States and the Soviet Union. But sensational headlines about the end of the Cold War, the reunification of Germany, and the irrelevance of the NATO Alliance must not obstruct a reasoned analysis of significant trends that are already exerting pressure on the structure of military cooperation in the West. These include:

- increasing capacity and parity in the development and production of advanced weapons systems throughout Western Europe and the Western Pacific;
- overcapacity in many sectors of global defense industries;
- economic integration of Western Europe pursuant to the Single Europe Act;
- consolidation and contraction of the defense industries, both in Europe and in the United States;
- globalization of the defense industrial base; and
- decline in defense budgets.

⁸It is **highly** unlikely that any NATO country would permit a U.S. company to **codevelop** and produce a major weapons **system**, even **one based on** U.S. technology, if the U.S. Government did not share in the development and **procurement costs**.

⁹**General Dynamics used this circumstance** to political advantage during the **FSX** debate, asking its potential subcontractors to write members of Congress in support of the **FSX** deal.

These factors are already creating significant adjustment in the U.S. defense industries and in the structure of international collaboration; adjustments that will be accelerated by events in Eastern Europe.

HISTORICAL PERSPECTIVE

In the first two decades following the Second World War collaboration in defense technology meant that NATO Allies bought defense equipment from the United States. As a consequence, nearly all NATO military technology and equipment initially incorporated U.S. specifications and standards. But the period of U.S. domination of these weapons markets and technology ended in the early 1960s, when the United Kingdom began to develop its first military airplanes of the post World War II period, and the French followed suit with domestically developed tanks and aircraft.

In the Western Pacific, cooperative defense programs have been an important element of U.S.-Japanese relations since 1954, when the Mutual Defense Assistance Agreement established the legal basis for the United States to supply Japan with military equipment and technology. Similarly, South Korea has purchased and continues to buy large amounts of U.S. military equipment since the end of the Korean War. Other forms of collaboration emerged with South Korea in the 1970s with the transfer of technical data packages to Korean defense firms, and in the 1980s, with licensing and coproduction of U.S. military systems such as the M109 howitzer and the F-5E fighter.

Intra-European codevelopment of weapons systems, particularly in aerospace programs, began in earnest in the middle to late 1960s. In 1965, France and the United Kingdom created a joint company, Sepecat, to build the Jaguar. In 1968, the United Kingdom, West Germany, and Italy established two new international concerns, Panavia (for aircraft) and Turbo-Union

(for engines) to build the Tornado, an advanced fighter for its time. In 1969, France and West Germany joined together to develop the Alpha jet. These early efforts at collaboration enabled the European powers to pool their defense industrial and financial resources, and to lessen their dependence on the United States for defense equipment.¹⁰ They set the stage for the creation of a European armaments industry that by the 1980s produced military technology to rival that of the United States in many fields.

By the late 1970s, and with the support of Congress, most European countries had negotiated bilateral agreements, or memoranda of understanding (MOUs), with the United States that reduced trade barriers, specifically, waiving relevant buy-American statutes and regulations. By conservative estimates, in 1977 the trade imbalance in military equipment between the United States and Europe was 8 to 1 in favor of the United States. A decade later, that margin had decreased to less than 2 to 1. Beyond these direct, measurable sales, the United States depends on foreign defense companies for a large but unspecified number of parts and components, including communications systems, chemical defense equipment, and other items that employ a wide range of advanced technologies.

European nations are increasingly reluctant to buy military equipment from the United States, or even to build systems that were initially designed and developed here.¹¹ Instead, our NATO Allies seek to enter into codevelopment projects, with each nation funding a share of the costs of the system. Such relationships are common among the European nations, where the escalating costs of modern weapons systems long ago outpaced the ability and political will of most single countries to afford them. Insistence on developing part of a system also reflects the desire of the participating nations and companies to increase domestic defense

¹⁰The process of indigenization of defense capacity will be discussed in the chapter 2.

¹¹This is due in part to their interest in building indigenous defense industrial capacity, and partly to U.S. technology transfer and security restrictions. The issue of U.S. unilateral export controls on military technology is addressed at the end of chapter 2.

industrial capacity, and at the same time, to position themselves to take advantage of commercial applications of new and evolving technologies. Many European defense companies also develop products for civilian high-technology markets.

Collaboration in the development and production of military technology and systems is an extremely complex enterprise, and it takes many different forms. Among governments, it includes information exchange, coproduction, co-development, security assistance, direct commercial sales, and other mechanisms. Some arrangements are open-ended, with virtually no commitments other than to talk. Others result in major financial investments and the transfer of critical know-how among nations. Pursuant to the 1986 Nunn amendment, the United States has entered into approximately 25 agreements to fund the initial R&D for new weapons systems jointly with one or more of its NATO Allies. These programs initially held great promise, and were seen as important in the context of strengthening NATO, both militarily and politically.

Although they constitute the principal means for DoD to encourage codevelopment with the European Allies, the Nunn amendment programs have encountered many difficulties and stumbling blocks. Several key programs will not go forward, including the NATO Frigate Replacement (NFR90), NATO Anti-Air Warfare System (NAAWS), Autonomous Precision Guided Munitions (APGM), and the Modular Stand Off Weapon (MSOW); and in others, such as the NATO Identification System (NIS) and Multi-Functional Information Distribution System (MIDS), one or more of the Allies has pulled out. While each failed attempt is a separate story, harmonizing military requirements among nations with different geographical and strategic concerns appears to be extremely difficult. This problem is likely to grow as the perception of the common Soviet threat to Europe declines.

Other factors, notably, the administrative complexities associated with meeting the regulations and requirements of two or more nations, have also created hurdles for the Nunn programs. When one nation pulls out, there is usually a domino effect, leading to abandonment of the program. In addition, there are indications that the U.S. military Services initially viewed the Nunn funding as an extra pot of money to be applied to projects that were of low priority to U.S. war-fighting capabilities.¹² Some industry analysts argue that, even if the surviving programs do make it past the development phase, there will not be sufficient funding in Europe or in the United States to go into production of low-priority systems. As the Nunn amendment programs have demonstrated, transatlantic government-to-government collaboration is a fragile process; and few programs have been successfully completed to date.

At the same time, direct collaboration between U.S. and foreign defense firms appears to be escalating. U.S. defense companies have entered into many different kinds of collaboration with their counterparts in other countries. These arrangements can take the form of direct subcontracting, joint ventures, teaming agreements, consortia, licensed production, offset agreements, data and personnel exchange, and many other financial and business interactions. Table 1-1 summarizes the different forms of collaboration.

The remainder of this chapter presents additional findings of this OTA Special Report. These findings are based on a review of the literature, interviews by OTA staff, and comments by outside experts. Chapter 2 expands on the findings and discusses the major issues related to international armaments cooperation. Chapters 3 to 5 and appendixes A through D contain the background material and analysis on which the findings are based.

¹²The exceptions, such as NAAWS, APGM and the Surface Ship Torpedo Defense program, tend to prove the rule. But even here, the importance of the programs has not been sufficient to overcome the difficulties associated with government-to-government transatlantic collaboration.

Table I-I—Forms of Collaboration in Defense Technologies

Data and scientist/ engineer exchanges	Technology transfer through individuals.
Sourcing	Direct purchase of a foreign-made part for a U.S. weapon system.
Subcontracting	U.S. prime contractor contracts with a foreign company to develop or produce a portion of a U.S. system.
Licensing	Selling or buying the rights to produce another firm's product.
Foreign Military	
Sales (FMS)	Government sales of U.S. hardware abroad.
Coproduction assembly	FMS with shared production and/or assembly.
Codevelopment	Joint design, engineering and/or production.
Teaming	Collaboration on a specific program as prime or subprime (also multiprogram teaming).
Alliances	Loose agreements to collaborate in specific areas of technology.
Joint venture	A jointly owned corporate entity to pursue a particular program or class of programs.
Consortium	Loose agreement of several partners to pursue a technology area from shared resources with shared revenues.
Revenue sharing	Joint activity where each partner invests in his area with agreement to share benefits/profits.
Acquisitions	Outright purchase of a firm, either abroad or domestically.
"Family of Weapons"	Agreement to minimize overlapping weapons development by cooperating, used by NATO.

SOURCE: Office of Technology Assessment, 1990.

ADDITIONAL FINDINGS— Defense Industry and Technology

The principal findings of this Special Report are presented at the front in the section entitled *Overview and Principal Findings*. What follows are additional findings related to defense industry and technology in the United States, Western Europe, and the Western Pacific.

United States

- Industry-to-industry or direct cooperation between U.S. and foreign defense companies is increasing dramatically. It has long been the preferred means of international arms collab-

oration, and can take almost as many forms as there are entrepreneurs willing to participate. The major incentive is economic. Industry seeks access to foreign markets, and deals will be structured so that participating companies make money and/or receive technical leverage, irrespective of national origins and loyalties. Industry-to-industry cooperation allows companies to make arrangements that are profitable and make sense for the corporate participants, but the national interest may not be fully factored into the economic equation.

- Overcapacity of the defense industries is increasing on a global scale. Major U.S. defense producers expect worldwide military funding to decrease over the next several years, and then to stabilize at much lower levels. This will cause intense competition, contraction, and restructuring in the U.S. and Allied armaments industries. Large U.S. companies are already rationalizing operations, laying off workers, seeking new markets, and forming strategic international alliances to weather the storm. U.S. subcontractors, who do not have these options, are likely to call for protective legislation, and many will leave defense work or go out of business.
- The United States can no longer expect most of its European Allies and Japan to buy or even coproduce major weapons systems that were originally designed and developed in the United States. Allies increasingly insist that collaboration take the form of cooperative development to enhance their domestic technology bases. They are especially interested in technologies that have significant civilian applications. Unlike many major U.S. defense companies, the European and Japanese counterparts have active interests in dual-use technology, stemming from their commitments to producing and selling in consumer markets.
- Large multinational Japanese and European companies that produce military systems may be able to withstand future defense budget

cuts better than their U.S. counterparts. They are also better able to absorb dual-use technology. This is largely due to their commitment to marketing, manufacturing, and selling consumer products. For example, MHI, Japan's largest defense producer, dedicates only 15 percent of its business to military production, as compared to GD's 85 percent and Lockheed's 95 percent.

- Foreign companies have acquired U.S. defense industrial base assets in recent years, and the trend appears to be increasing, although the precise extent of foreign penetration is unknown. Foreign defense companies increasingly seek strategic business alliances with U.S. partners or acquisition of firms located in the United States as a means to penetrate the U.S. market.
- If technology security and restrictive technology transfer policies are not reformed, they will damage the international business prospects of U.S. companies. Many of the reasons for which they were instituted have been obviated by diffusion of defense technology around the world, by recent political changes in Eastern Europe, and by the decrease in military tensions between the United States and the Soviet Union. On the other hand, as Third World conflict goes high-tech, controls on defense-related collaboration and technology transfer to Third World countries may become increasingly important and desirable. A national security review of U.S. export control policy has been ordered by the President, and major changes are expected in the Export Administration Act, which will be considered by Congress in September 1990.

Western Europe

- Defense budgets in Western Europe have declined since the mid-1980s. With the rapid collapse of Communist regimes in Eastern Europe, further steep declines are anticipated. At the same time, the Europeans expect that increasing global overcapacity in the defense industries will result in fierce competition

with the United States-and perhaps eventually Japan and the newly industrialized countries-for shrinking defense markets in NATO and Third World countries. Many European nations, especially France, view arms exports as an important element in the overall trade picture.

- European defense industries have been restructuring through mergers and acquisitions to obtain the requisite size and technology base to meet this challenge. In the key aerospace and defense electronics sectors, the trend is for each major producer (i.e., France, Great Britain, Italy, and West Germany) to retain one or two integrated national champions. These firms are creating intra-European strategic alliances through stock swaps, joint acquisitions, and teaming on specific projects.
- Elements of national rivalry still exist among major European defense producers. At the same time, there is a strong trend toward governmentally sponsored intra-European defense industry cooperation, centered on the reactivated Independent European Programme Group (IEPG). European defense industry also benefits from a variety of government supported cooperative research programs in civilian dual-use technologies. EC 1992, while ostensibly excluding defense trade, will have a major impact in the defense area because most major European defense producers have important civilian sector interests.
- European industry considers access to the U.S. defense market to be essential, but many believe that the United States will eventually be closed to direct sales. Accordingly, there is increasing European interest in acquiring U.S. defense suppliers and in teaming arrangements with U.S. prime contractors. The full extent of European penetration of the U.S. defense market is difficult to ascertain, but there are indications of a significant increase in the past several years.

. As a forum for coordination of Allied defense industrial programs, NATO may have been weakened by the activation of the non-NATO IEPG, and the general increase in intra-European industrial cooperation. While all members of the IEPG are also members of NATO, the IEPG specifically excludes the United States and Canada. The 1986 Nunn amendment programs may be in jeopardy due to expected budget shortfalls, a general shift away from government-to-government collaboration, a redefinition of the military threat to Europe, and pressures toward pan-European defense programs.

Western Pacific

- **The** United States and Japan have a long history of collaboration in defense technology, dating back to the Mutual Defense Assistance Agreement of 1954. Most cooperation has taken the form of coproduction, with Japanese firms producing equipment, initially developed in the United States, under licensing agreements with U.S. defense companies. The FSX codevelopment project represents a radical departure from the established historical relationship.
- . Japanese defense policies are changing in subtle and significant ways. Japan has dropped its requirement that defense spending be limited to 1 percent of GNP, although the 1 percent level is still approximately observed. In concert with Japan's GNP, Japanese defense budgets have expanded rapidly in recent years, partly in response to pressure from the United States to accept more of the burden of defense in the Western Pacific. In addition, the Japanese Government has modified its prohibition on the export of military equipment to permit the flow of defense technologies to the United States. Finally, Japan and the United States have recently reached a basic agreement to cooperate on the research for three militarily critical technologies. These changes have prompted concern over what some analysts have called the remilitarization of Japan.
- Important Japanese companies like Mitsubishi, Toshiba, and Nippon Electric made major investments in defense production in the 1980s, and Japan now produces over 80 percent of its weapons and military equipment domestically. Nevertheless, these companies allocate only a small percentage of production to defense. In Japanese companies, civilian technology flows easily into defense applications and vice versa.
- The United States increasingly depends on Japanese manufactured items to build its defense systems. The Department of Defense and U.S. defense firms purchase significant numbers of Japanese components for weapons systems assembled in the United States. The degree of such dependence is unknown, but there is general agreement that it is increasing, especially in the field of high-technology electronic parts and components. One U.S. defense company indicates that it conducted approximately 1 billion dollars' worth of business with Japan over a 3-year period.
- The FSX controversy has complicated any future collaboration between the United States and Japan in defense technology. In the United States, the press, the administration, Congress, and defense analysts will follow the deal closely for evidence of adverse economic impacts or bad faith on the part of the Japanese. In Japan, both industry and government officials question whether the United States will be a reliable partner in the future. Most analysts agree the FSX controversy damaged relations between the two countries.
- South Korea is attempting to develop a significant role for Korean defense firms as suppliers of military parts and components to major U.S. companies that produce defense equipment. This strategy is due in part to idle capacity (approximately 40 percent) in the Korean arms industry. In sharp contrast to Japan, Korean policy calls for export of arms and defense technology. This policy created

friction between the United States and Korea throughout the 1980s; in some periods, the U.S. Government has denied over 50 percent of South Korea's applications to export U.S.-origin technology to third countries.

- South Korea lags far behind Western countries and Japan in defense R&D. Korean firms have not yet devoted large resources to military R&D. Throughout the 1980s South Korean military R&D expenditures amounted to only about 1.6 percent of military budgets.
- It is not clear how the changes sweeping Europe and the Soviet Union will affect the security of the South Koreans. North Korea possesses a formidable threat with armed forces of over 1 million, an Army of over 800,000, 540,000 reserves that can be mobilized within 12 hours, 3,500 tanks, and over 4,000 heavy artillery pieces and rocket launchers. Given this threat, and their problems with U.S. technology controls in the 1980s, it is highly unlikely that the South Koreans will abandon their drive to develop an advanced defense industrial base in the near term, even though they have recently agreed in principle to normalize relations with the Soviet Union.
- The United States has signed memoranda of understanding regarding transfer of military technology with most of the Association of Southeast Asian Nations (ASEAN) countries. In part, the United States supplies Indonesia, Singapore, and Thailand with weapons systems and military technology to strengthen security ties with the ASEAN nations. These countries have all purchased F-16 fighters from the United States or have placed orders for them. They have not yet developed their indigenous military industries to a point where they could offer serious competition to U.S. companies.
- Australia purchases approximately 2 billion dollars' worth of U.S. military equipment and technology a year. They require a 30 percent offset for military purchases over \$200 million. Australia is developing a defense industry, but maintains that its purpose is not to compete with U.S. companies. Rather, they hope to build an indigenous capability to service equipment that is purchased from the United States.

Chapter 2

**Implications and Issues
for Congress**

CONTENTS

	<i>Page</i>
WHY COLLABORATE?	21
THE DEFENSE TECHNOLOGY ENVIRONMENT HAS CHANGED	24
Trends in Defense Technology	24
The Future of Collaboration	26
CHANGE IN THE DEFENSE INDUSTRIES	27
DEFENSE INDUSTRIAL POLICY: What Hasn't Changed	29
POLICY ISSUES FOR THE 1990s	30
Revamping the Defense Industrial Base	30
The Role of Government in Defense Industrial Cooperation	33

Figures

	<i>Page</i>
2-1. Balance of High-Tech Trade, 1970-88	25
2-2. U.S. Defense Contractors by Prime Contract Award, Fiscal Year 1989.....	28
2-3. Leading Arms Importers, 1987	34
2-4. Arms Exports, <i>Cumulative Sales</i> , 1977,87	35

Table

	<i>Page</i>
2-1. Summary of Foreign Technological Capabilities	26

Implications and Issues for Congress

International collaboration in defense technology is an extraordinarily complex business at best, and is becoming increasingly messy as the old assumptions of the post-WWII order give way to new forms of technical, industrial, political, and alliance organization around the globe. We have entered a period where dramatic restructuring of Eastern European governments and East-West relations has been superimposed on a process of gradual, but significant change in the balance of economic, technological, and military power in the international state system. The context for U.S. arms cooperation with other nations has shifted, not only with regard to dramatic events in Eastern Europe, but also with respect to the lowering of trade barriers and the consolidation of the defense industries in the European Community. U.S. policy on arms cooperation remains wedded to an older, simpler era. It has also failed to adapt to the rise of economic nationalism in the Western Pacific and the development of rival defense industrial bases, both in Asia and in Europe.

WHY COLLABORATE?

Not many years ago, the United States collaborated with its NATO Allies to achieve objectives that were easy to understand but difficult to implement. As the undisputed leader of the Free World, the United States sold military technology to the Allies for the purpose of building up their defense and civil industrial bases that had been devastated in World War II. In the context of the Cold War, the United States sought to enhance the overall military capacities of the NATO Alliance; to achieve economies of scale, interoperability, and standardization of military equipment; and to maintain a coordinated conventional deterrent to a Warsaw Pact invasion of Western Europe. But the period of U.S. dominance of defense technology and markets is over, and the goal of setting and meeting common defense equipment requirements through transatlantic cooperation has not been realized—although efforts to do so are continuing.

Different nations collaborate in defense technology for different reasons. These include the nature of the military threat, the structure of regional security alliances, defense and political ambitions, economic vitality, and the level of technological and industrial development. Israel, for example, collaborates with

the United States, and a large number of other countries, because its survival depends on the capability of its armed forces, which was tested in 1948, 1956, 1967, and 1973. It has also benefited through aggressive export of weapons made in Israel. The Republic of Korea (ROK) faces a significant and sustained military threat from North Korea. It has collaborated primarily with the United States because of the strength of the U.S.-ROK security relationship since the Korean War. As the United States contemplates reduction of its troops in Korea, Korean interest in collaboration has increased as a means of building an indigenous defense technology and industrial base. The Koreans are beginning to look beyond the traditional U.S. relationship for new partners, both in Asia and in Europe.

Their close neighbors, the Japanese, have pursued a very different strategy. Japan does not enter into regional security agreements, and has cooperated in defense technology almost exclusively with the United States. Japanese leaders are politically wary of investing in defense technology, and this has freed them to concentrate their assets on technology and manufacturing for consumer markets. Although the Japanese generally prohibit the export of defense technology, they have made an exception in the case of the United States. On the other hand, they have adopted a narrow definition of defense materiel, and impose few prohibitions on exporting dual-use items, even when they ultimately end up in the arsenals of other nations.

In Europe, the situation is somewhat more complex, and it has evolved over time. Today, smaller countries, such as Holland and Belgium, collaborate largely because they do not have the financial resources or industrial infrastructure needed to build state-of-the-art weapons systems that require the development of a full spectrum of advanced technology products. At the other end of the spectrum, the major European powers, Britain, France, West Germany, and Italy, are certainly able to build modern defense systems, but they have chosen to collaborate, often with other European nations, to decrease costs, to achieve economies of scale, to build their technology bases, and because they do not fear the loss of business to foreign suppliers.

U.S. policymakers have tended to view international armaments cooperation as symbolic of NATO Alliance cohesion and the strength of political relations in the West. The U.S. position as a military and economic superpower meant that it could underwrite the security of the West, with little regard to the cost of modern weapons, while its allies viewed cooperation in defense technology in very different terms.

The Europeans saw collaboration as a means of acquiring foreign technology, employing local populations, building up industrial infrastructure, and enhancing overall economic vitality. They have been willing consistently to pay a substantial premium, either in terms of increased costs or decreased military performance, in order to produce weapons systems in Europe. A clear progression in the structure of transatlantic cooperation in military technology has coincided with these largely Eurocentric and national objectives.

Initially, the European powers bought U.S. military equipment through government-to-government foreign military sales programs. But while different nations pursued different strategies, and the details varied significantly from one collaboration to the next, a clear pattern emerged. The next step was to engage in licensed production or coproduction of a limited number of military items, usually because the European ally could not afford to produce the system independently. Soon, however, the acquiring nation demanded a piece of the action, sometimes in the form of a direct offset agreement to produce a component of all future copies of the system in question. The next step was to engage in cooperative codevelopment of the next generation of an existing weapons system. Finally, the acquiring nation or group of nations undertook production of an indigenous fighter, tank, radar, or other system. For most of our NATO Allies, the answer to the question "why collaborate?" is simple enough: to share costs and to further the drive toward national or regional

self-sufficiency in the development and production of military technology and systems.

This process, which might be called "indigenization," is somewhat oversimplified above, but it has not been limited to NATO. Our allies in the Western Pacific have also increased their military power by tapping into U.S. defense technology. Japan has long depended on the United States to provide technology needed to produce its military aircraft. Of the 36 types of aircraft flown by the Japanese Self Defense Forces, 9 were purchased directly from the United States, 16 were coproduced, and several are copies of low-technology U.S. aircraft.¹ Part of the controversy over the FSX fighter deal with Japan stemmed from concern in Congress that the Japanese had indeed progressed to the phase of codevelopment of a next generation fighter to follow the F-16. The irony was that the Japanese initially planned for indigenous development of the FSX, and were dissuaded by the efforts of the U.S. Department of Defense (DoD).²

The military aspect of international trade in defense technology takes on added dimensions in East Asia, where nations, such as Japan and South Korea view defense collaboration as part of an overall industrial and technology strategy. This can be seen in the way that they have organized their industrial bases to include defense production.³ The United States appears to be alone among advanced industrial nations in its rigid institutional and legal separation of the production of military and civilian technologies. DoD regulations make it extremely difficult for a large company to organize itself to produce military materiel and consumer products under one administrative roof.⁴

Many European defense executives have commented that Europe does not have a defense industrial base. Instead, major companies that produce weapons also make consumer products and so are part of one integrated industrial infrastructure.⁵ In Japan, military and civilian technology are pursued

¹Richard J. Samuels et al., "Defense Production and Industrial Development: The Case of Japanese Aircraft," MIT Japan Science and Technology Program, 1988, p. i4.

²Some observers believe that Japan originally planned to buy a new fighter off-the-shelf from a U.S. defense company. See Clyde V. Prestowitz, Jr., *Trading Places* (New York, NY: Basic Books, Inc., 1988), pp. 10-11.

³This aspect will be taken up in greater detail in the final report of this assessment.

⁴The barriers that exist between the civilian and military sectors of the economy are examined at length in U.S. Congress, Office of Technology Assessment, *Holding the Edge: Maintaining the Defense Technology Base*, OTA-ISC-420 (Washington DC: U.S. Government Printing Office, April 1989), see ch. 9 and passim.

⁵From a Workshop on Transatlantic Cooperation in Defense Technology—European Perspectives, held at the office of Technology Assessment On Sept. 11, 1989.

under a single industrial structure, where military production typically accounts for less than 15 percent of a company's sales. Because their defense industries are less insulated from civilian economic activity, many Asian and European companies are better positioned to take advantage of the dual-use aspects of technology, to apply advances in consumer electronics, for example, to military systems. Similarly, new military innovations, whether produced at home or acquired through international collaboration, can more easily be engineered into civilian products. Nations and companies collaborate to gain new technology, technology that can be moved from military to civilian applications within the divisions of a single company or group of companies.

Some military analysts believe that the United States must maintain a separate defense technology and manufacturing base if it is to retain its role as a military superpower in international affairs. To be a superpower, it is necessary to produce leading-edge military technologies in many different fields. They distinguish rigorously between dual-use manufactured items, such as advanced semiconductors, that are increasingly incorporated into U.S. weapons systems, and state-of-the-art military technologies needed to build an Advanced Tactical Fighter (ATF), a National Aerospace Plane (NASP), or Strategic Defense Initiative (SDI) systems. Japan excels in the former but is not in the same league with the United States in the latter. Accordingly, the ATF, NASP, and SDI systems would not be built if the Nation relied on the civil industrial base alone, because business would not make the necessary investment in R&D with no civilian market to justify it.

But the argument can be taken a step farther. If the military depends too heavily on dual-use technology, it will lose its leadership position because dual-use technologies are more widely available, and most modern militaries have them. The only reason that the United States leads Europe and Japan in next-generation defense systems is that the United States has made the investment in military-specific technologies that may not have civilian applications for many years, if at all. In this view, the United States will have to retain the kind of defense industrial structure that it has today, including a

largely separate manufacturing infrastructure for weapons systems, if it is to retain its superpower status. These analysts argue, accordingly, that a decision to reduce the defense budget drastically in response to the end of the Cold War would also be a decision to abandon leadership as a military power. From a military perspective, these factors tend to militate against international collaboration. As one high-ranking officer put it: "If we want to stay a superpower, we will invest to be ahead of the world in next generation systems . . . Otherwise, we are co-developing and therefore not leading. We lose the superpower label."

The reasons why the United States collaborates with its allies in military technology are no longer as clearly defined or as universally accepted as they once were. Indeed, the center of gravity in international collaboration has shifted away from government-to-government agreements, which were largely driven by foreign policy objectives and Alliance military strategy. Most collaboration is now initiated on an industry-to-industry basis, where U.S. defense companies enter into licensing agreements, joint ventures, codevelopment arrangements, and business alliances with foreign companies.

The dilemma for policymakers is that the interests of the U.S. defense companies may not coincide with the future national interests of the United States. This divergence will increase to the degree that present negotiations for the reduction of troop levels and conventional forces in Europe are successful. For example, if future arms control agreements ban or obviate the need for planned follow-on forces attack systems, it would no longer be in the interests of the United States to build them, even though revenues for U.S. defense companies would be substantially reduced.⁶ Beyond this obvious impasse, there are other, more subtle points of divergence.

Many large U.S. defense companies, for example, seek to increase their international business as part of a strategy to survive large program cancellations and budget reductions in the future. They hope to use international collaboration to enter foreign markets, where demand for their products is still high and profits are not regulated. The motivation behind their international operations is to make money, and properly so, from a business perspective. These

⁶FOFA stands for Follow-on Forces Attack. For a complete assessment of FOFA, see U.S. Congress, Office of Technology Assessment, *New Technologies for NATO: Implementing Follow-on Forces Attack*, OTA-ISC-309 (Washington, DC: U.S. Government Printing Office, June 1987).

companies argue that cooperation allows the United States to exploit foreign technology, to obtain the best defense products at the lowest price, to sell to a much larger market, and to ensure the future viability of the U.S. defense industry.

But from a national perspective, international collaboration can increase U.S. dependence on potentially unreliable foreign sources to unacceptable levels, erode the middle tiers of the U.S. defense industrial base, take business away from U.S. companies and jobs from U.S. workers, and transfer valuable technology to competitors that may later be used to penetrate civilian markets in the United States.

Perhaps most important, industry-to-industry collaboration reduces government control over the distribution of advanced defense technology. In this respect, governments have always controlled the output of the defense companies, because the allocation of sophisticated weapons can change the balance of power among nations in the international state system. Stated more simply, we don't want to sell them something that might ultimately be shot back at us. The privatization of international defense cooperation raises vexing issues for U.S. policy on international collaboration. These are discussed in greater detail in the final section of this chapter.

THE DEFENSE TECHNOLOGY ENVIRONMENT HAS CHANGED

Changes in the balance of both economic and technological power between the United States and its allies in Europe and Asia have reshaped the environment in which cooperation in military technology takes place. But relevant U.S. policies have remained largely the same. Changes in the environment of defense technology, alone, would require different policies and a different approach to cooperation with our allies in the development and production of future defense equipment. Unfortunately, Congress will have to face an already difficult policy environment that has been made more complex by a sea change in relations between the United States and the Soviet Union, and the

political restructuring of some half dozen nations in Eastern Europe.

Trends in Defense Technology

Perhaps the greatest change in the past decade is that technology leadership in defense has dispersed around the world. Today, the ability to produce advanced technology with military applications is widespread, and the United States is no longer the leader in some technologies that are vital to military systems. The United States still produces state-of-the-art and next generation defense systems and equipment, and the sheer size of its market and industry creates the illusion that it is far out in front of the European powers, the Japanese, and others.⁷ But advances in military and dual-use R&D, technology and manufacturing capacity in Europe and Asia have created rough equality on three continents for many different technologies used in building defense systems. This can be seen in the successful efforts of European defense firms to penetrate niche markets in the United States by forming alliances with U.S. prime contractors. One incentive for the U.S. partner is to gain access to first rate foreign technology; another is to gain reciprocal access to foreign markets.

But proliferation of increasingly capable centers of defense technology has also created global overcapacity in many defense industries.⁸ By building up the military and industrial capability of its friends and allies, the United States has also helped to create formidable competition for shrinking defense markets. Even before the relaxation of military tensions between NATO and the Warsaw Pact, the defense industries of the West and of the Far East were characterized by growing overcapacity. In South Korea, for example, the defense industry is presently running at 60 percent of capacity. In the United States, Congress and the Department of Defense have funded acquisition and procurement of military systems to support many more production lines than can be justified on both national security and economic efficiency grounds.

The problems associated with technological leveling in the military sphere are linked closely to the fate of U.S. technology and industrial leadership in

⁷Indeed, the United States is a leader in many military fields, such as those related to signature control and nuclear directed energy weapons, that are so expensive or so military-specific in application that other nations have not pursued them.

⁸In the period from 1982 to 1987, world arms imports and exports decreased by 4.6 percent. At the same time, world military expenditures increased by 1.8 percent, indicating that there are fewer foreign outlets for increasing defense capacity. Data taken from tables 1,2, and 4 in U.S. Arms Control and Disarmament Agency, *World Military Expenditures and Arms Transfers 1988*, June 1989, pp. 2, 4, and 7.

Figure 2-1—Balance of High-Tech Trade, 1970-88

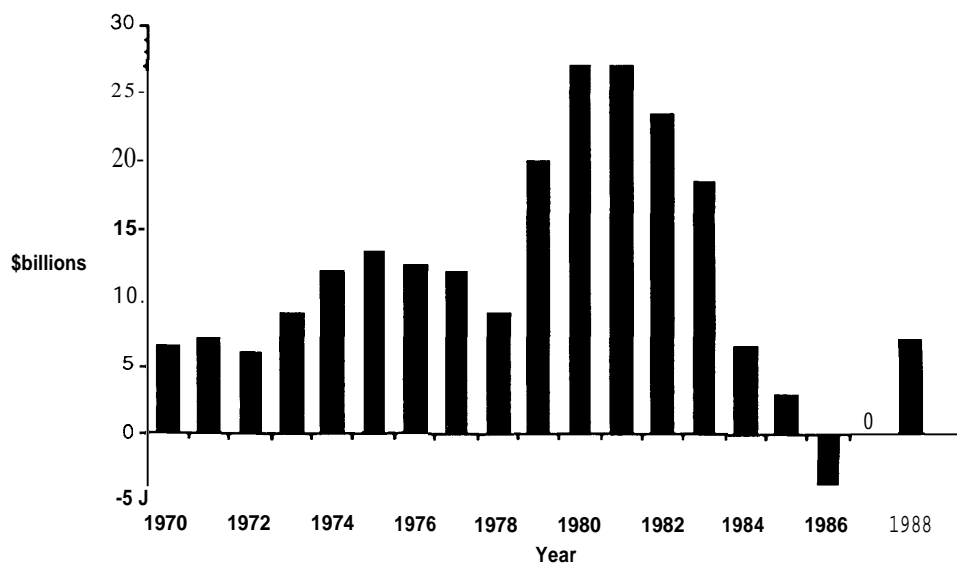

SOURCES: U.S. Department of Commerce and National Science Foundation, 1989.

general. A generation ago, U.S. technology led the world, and military technology in particular was unrivaled. Two trends have changed this picture substantially. The first is that military procurement no longer drives innovation in the United States; much leading-edge technology is now pulled forward by markets for consumer goods. Second, U.S. manufacturing and sales have taken a back seat to foreign competition in one product line after another. Today, there are large areas in consumer electronics where the United States is not a significant player, and emerging technologies, such as high-definition TV, where the United States may never get into the game.

This is a significant problem because the distinctions between military and non-military technology, industry, and markets are breaking down. If the United States cannot compete in international consumer markets, it will ultimately come to depend on foreign dual-use technology in the production of the next generation of weapons. In this context, the U.S. negative balance of trade in high-technology goods with both the European Community member nations and Japan takes on greater weight. (See figure 2-1.) There is substantial evidence that Japanese and European firms produce critical parts and compo-

nents for U.S. defense systems.⁹ Of the 20 technologies listed by DoD in its 1990 "Critical Technologies Plan" at least 15 are dual-use.¹⁰ These include microelectronic circuits, software, robotics, photonics, composite materials, superconductivity, and biotechnology, among others. (See table 2-1.) Japan is a leader in many of these technologies, and exports them to the United States and other countries both for civilian and for military use.

Substantial interdependence already exists between the United States and its allies, from innovation through production, in technologies used in military systems, and it is likely to increase in the future. Dependence is incurred directly by many different types of international collaboration, including joint ventures, strategic alliances, codevelopment, and direct offsets. But it is also built into the structure of global competition and trade in dual-use technology among the advanced industrial, market-oriented countries. It is difficult to imagine a future in which some degree of collaboration in military technology is not economically and technically necessary. These changes in the environment of defense technology necessitate a rethinking of the meaning of national security and its relationship to overall economic competitiveness.

⁹See Martin C. Libicki, Jack Nunn, and William Taylor, *U.S. Industrial Base Dependence/Vulnerability: Phase II-Analysis* (Washington, DC: National Defense University, November 1987), ch. 3 and *passim*.

¹⁰U.S. Department of Defense, *Critical Technologies Plan*, prepared for the Committees on Armed Services, U.S. Congress, Mar. 15, 1990, p. ES-1.

Table 2-1-Summary of Foreign Technological Capabilities

Critical technologies	Dual-use	U.S.S.R.	NATO allies	Japan	Others
1. Semiconductor materials and microelectronic circuits	√	★	☆☆	☆☆☆☆	☆☆ Israel
2. Software producibility	√	★	☆☆	☆☆	☆☆ Various countries
3. Parallel computer architectures	√	★	☆☆	☆☆	☆☆ Switzerland, Israel, Hungary
4. Machine intelligence and robotics ..	√	★	☆☆☆	☆☆☆☆	☆☆ Finland, Israel, Sweden
5. Simulation and modeling	√	★	☆☆☆	☆☆☆	
6. Photonics	√	★★	☆☆	☆☆☆☆	☆ Various countries
7. Sensitive radars	√	★	☆☆	☆☆	☆☆ Sweden
8. Passive sensors		★★	☆☆	☆☆	
9. Signal processing	√	★★	☆☆	☆☆	☆☆ Sweden, Israel
10. Signature control		★★	☆☆	☆☆	
11. Weapon system environment	√	★★★	☆☆☆	☆☆	☆ Various countries
12. Data fusion	√	★★	☆☆	☆☆	☆☆ Israel
13. Computational fluid dynamics	√	★	☆☆	☆☆	☆☆ Sweden, Israel
14. Air-breathing propulsion	√	★★	☆☆☆	☆☆	☆ India, China, Australia
15. Pulsed power		★★★★	☆☆	☆☆	☆ Various countries
16. Hypervelocity projectiles		★★★★	☆☆	☆☆	
17. High-energy density materials		★★★★	☆☆☆	☆☆☆	
18. Composite materials	√	★★	☆☆☆	☆☆☆	☆☆☆ Israel
19. Superconductivity	√	★★	☆☆	☆☆☆☆	☆☆☆ Switzerland
20. Biotechnology materials and processes	√	★★	☆☆☆	☆☆☆☆	☆☆ Various countries

LEG
 Position of U.S.S.R. relative to the United States.
 ★★★ Significant leads in some niches of technology
 ★★ Generally on a par with the United States
 ★ Generally lagging except in some areas
 * Lagging in all important aspects

Capability of others to contribute to the technology.
 ☆☆☆ Significantly ahead in some niches of technology
 ☆☆☆ Capable of making major contributions
 ☆☆☆ Capable of making some contributions
 ☆ Unlikely to make any immediate contribution

SOURCE: Adapted from U.S. Department of Defense, 1990.

The Future of Collaboration

Deepening detente with the Soviet Union has created vast uncertainties for U.S. defense strategy and policy. It has also introduced a measure of uncertainty into the economic and political future of the European Community. While it is difficult to remove the clouds from the crystal ball as yet, there are some constants. First, the trends in defense technology, identified above, are unlikely to be reversed by these political events. Instead, they will probably be aggravated by dramatic movement associated with the end of the Cold War. For example, the Bush Administration has already suggested reducing the barriers to technology transfer to Eastern European nations. In time, high-technology centers may evolve in countries that are now members of the Warsaw Treaty Organization, especially if German reunification proceeds quickly or if the European Community is expanded to include one or more of the Eastern European states.

Of more immediate concern, problems of overcapacity in the defense industries will be compounded as defense budgets fall, both in the United States and

in Europe. This has profound implications for the structure of the defense industries and the kinds of international collaboration that will be undertaken. Fundamentally, future defense collaboration is tied to the future of the defense industries. As defense business declines, it is not clear whether international collaboration will be used to create new efficiencies in defense production, or whether regional and national policies will be instituted to bolster indigenous defense industries.

The motivations that led the United States to collaborate with its allies in Europe have been weakened, if not altogether removed, by changes in the balance of transatlantic economic and technological power, and by the rush of recent events in Eastern Europe. The United States collaborated to build up Allied defense capacity, and as a symbolic enterprise to enhance the stability and cohesiveness of NATO. But as the U.S. lead in defense technology declines, and as the economic and technological strength of Europe expands, U.S. policy is becoming increasingly anachronistic. Similarly, as the threat of Soviet aggression recedes, and U.S. influence in NATO diminishes, enhanced European collabora-

tion in defense technology may become a vehicle for political consolidation of NATO Europe, replacing former U.S. efforts.

But the future of transatlantic collaboration, as well as cooperation with allies in the Western Pacific, does not depend on government policy alone. Industry-to-industry collaboration, the dominant form of defense cooperation, requires only an official nod, and is motivated by factors more tangible than alliance relations. It depends as much on the ability of large defense companies to engage in and make profits from defense markets around the world. Changes in U.S. Government policy, recent political changes in Europe, and changes in the environment of technology will all influence the structure of the defense industries in the near term, both in the United States and around the world. The remainder of this chapter discusses the structure of the U.S. defense industries, U.S. defense industrial policies, and the issues that are likely to require congressional consideration in the 101st and 102nd Congresses.

CHANGE IN THE DEFENSE INDUSTRIES

Over the past decade important sectors of the U.S. defense industry have internationalized their operations to respond to global changes in the environment of defense technology. In discussions with OTA staff, several of the largest defense contractors indicated that they conduct 15 percent or more of their defense business on an international basis. Because international operations are not as closely regulated by the U.S. Government, this 15 percent often translates into more than 25 percent of profits, adding pressure for increased penetration of foreign markets.¹¹

These companies would like to follow the lead of their civilian sector counterparts or parent companies, and conduct operations on a global scale, exporting production and even R&D when it makes business sense. They have not been able to do this

because U.S. defense policies have combined to make global operations less attractive or to prohibit them altogether. As one top defense executive put it:

We are exporters. We are not a global company because we have retained most of the capability for production in the United States. But we are international in our operations, in buying and selling, in joint ventures, strategic alliances, and in codevelopment and production arrangements. The best thing government could do for our international business would be to get out of the way.

The industries that supply defense equipment and conduct defense R&D in the United States can be divided into three broad groups. They are and will be affected differently both by U.S. policy on international collaboration and by projected reductions in defense budgets. The first group is comprised of some 50 of the largest defense contractors through which approximately 60 percent of the acquisition budget flows.¹² (Figure 2-2 displays the 20 largest defense contractors and their total contract awards in fiscal year 1989.) These companies, among others, have the capacity to enter into sophisticated international ventures. They are pursuing a number of strategies to cope with anticipated program cancellations and budget reductions.¹³

First, they are seeking additional international business and access to new foreign markets where profits are greater because they are not subject to regulation by the Department of Defense. Second, they are tightening their belts by dropping unprofitable operations and reducing their work forces. One of the largest companies is now in the process of laying off approximately 15,000 workers. Finally, they are working more closely with a smaller number of suppliers, and moving attractive production opportunities in-house as a way to increase revenues in a declining domestic market. By making these changes, these large companies hope to improve their chances of remaining in business during the coming defense downturn. There is a good chance that some will not.

¹¹Some analysts believe that foreign business is more profitable because fixed costs are amortized over U.S. production only, leaving a larger profit margin for foreign sales at the same unit price. However, defense company executives argue that foreign sales reduce costs to the U.S. Government because they increase production runs, thus introducing economies of scale.

¹²Figures calculated from "The Top 200 Defense Contractors," *Military Forum*, vol. 6, No. 1, August 1989, pp. 15-16.

¹³Many of these companies borrowed a great deal of money to invest in the development of new weapons systems during the Reagan Administration defense build-up, systems that may never be produced. Defense companies have written off about \$2 billion over the past 2 years, including Lockheed Corp. (\$500 million), Northrop Corp. (\$337 million), Honeywell Inc. (\$200 million), Unisys Corp. (\$150 million), General Dynamics (\$125.8 million), McDonnell Douglas Co. (\$124 million), and United Technologies (\$14 million). *Defense News*, vol. 5, No. 3, Jan. 15, 1990, p. 25.

Figure 2-2—U.S. Defense Contractors by Prime Contract Award, Fiscal Year 1989

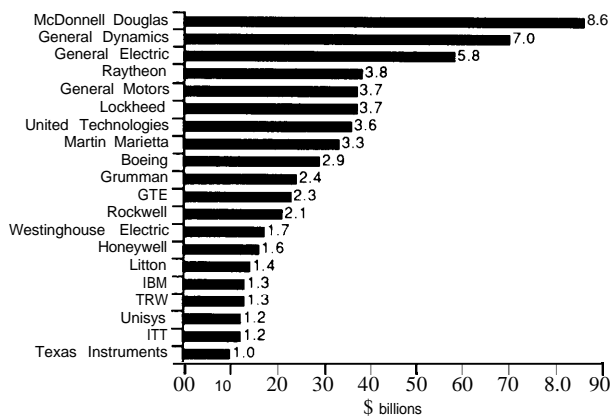

SOURCE: Data from U.S. Department of Defense, 1990.

Not all sectors of the defense industries are able to pursue these strategies. A second group of companies, sometimes referred to as the defense subtiers, depend on a chain of subcontracting arrangements descending from the first group of companies, the large system integrators, for most or all of their business.¹⁴ They are largely U.S.-owned, and most do not possess the financing or the know-how to enter into international business arrangements. They include large electronics houses as well as small, specialized machine shop operations. In recent years a small percentage of them have been bought by large foreign companies that seek an American presence as part of a long-term strategy of penetrating the U.S. defense market. In the past these subtier companies have been protected from the forces of international competition by a variety of defense policies. But the increasing internationalization of defense business poses a competitive threat to them. In the context of a defense downturn, they tend to view international defense business as a less-than-zero sum game. They have benefited from participation in the largest and possibly most protected defense market in the world. They will likely sustain heavy casualties in the context of shrinking defense

budgets, opening defense markets, and global overcapacity in defense production.

A final group of companies that supply parts and components for defense resides at the lower tiers in the chain of subcontractors. These are companies that do most of their business in the nondefense sector of the economy. Many operate globally and produce high-technology products; some do not maintain manufacturing operations in the United States. Because they do not depend on defense for any substantial part of their sales, most will be only marginally affected by changes in U.S. defense policies and by declines in domestic defense production. These companies are also largely exempt from the defense regulations that influence firms higher up the subcontracting chain because DoD specifications, regulations, and auditing procedures usually cannot reach them.¹⁵

These companies produce many of the dual-use technologies that were listed in the DoD “Critical Technologies Plan” and that are used in U.S. defense systems. Because there are often many levels of subcontractors between the dual-use suppliers and the initial prime contractor, DoD has few records that describe them as a group.¹⁶ Most of them would probably be unwilling to tolerate the government scrutiny that is typical in defense contracting at the middle and upper tiers of the defense industries. This group is important to defense, however, because they develop much of the innovative and leading-edge technologies needed for next generation weapons systems. But their involvement in defense is a double-edged sword; the technologies and products these companies supply also introduce a large measure of dependence on foreign industry and sources.

DEFENSE INDUSTRIAL POLICY: WHAT HASN'T CHANGED

In considering any future policy framework for international defense cooperation, Congress may wish to take into account the strengths and vulnera-

¹⁴The large companies in the first group often perform subcontractor work for other large companies (and occasionally for smaller ones). Companies in this second group can be prime contractors, but usually are not. Some provide finished products that are sold directly to the government (e.g., radios, boots, pistols, etc.), but most produce parts that are integrated into larger systems (e.g., signal processors, sensors, fuel tanks, motors, etc.).

¹⁵For purposes of contract compliance, a prime contractor relies on its second-tier contractor to confirm that all subcontracted goods are produced to specification. There are some auditing and compliance procedures at this level. But the second-tier subcontractor relies in turn on the assurances of the third-tier subcontractor, and soon down the line. At some point, the auditing trail ends, and the government is unable to determine who the actual supplier is, and whether the part or other item in question was foreign-sourced.

¹⁶As one influential member of the Defense Manufacturing Board put it, “Once you get down below the level of the primes, DoD doesn’t know what in the hell is going on.”

bilities of the different industrial sectors that supply defense. To a great extent, U.S. Government policy already shapes and controls the structure of the defense industries, the international arrangements they may engage in, and their access both to domestic and foreign defense markets. European and other foreign observers have long insisted that in matters of defense industry and technology, the United States does have an industrial policy. They have been quick to add that it is an awkward and inefficient one. Nevertheless, the U.S. defense market is highly protected; DoD routinely picks winners and losers, especially in the winner-take-all sweepstakes for major weapons systems; DoD supports excess capacity, most notably in the aerospace industry; and DoD regulations result in separate defense and nondefense industry operations.

How does U.S. policy ensure a largely protected marketplace for domestic defense companies? Compliance with the Defense Federal Acquisition Regulations alone is so complex that few foreign firms can manage it without a significant U.S. presence. In addition, the security classification system serves as a major nontariff barrier to foreign entry into the market. When a U.S. defense company is acquired by a foreign-owned corporation, its security clearances can be withdrawn, and it may be required to shut its doors to further work until the clearances are restored. Depending on the nature of the defense work and the ownership of the company, this can be a long, drawn-out procedure, and reinstatement of clearances can be denied for a variety of reasons that are difficult to challenge. Accordingly, many foreign firms that seek to penetrate the U.S. market form alliances with or become subcontractors to established U.S. prime contractors, and avoid equity investments in U.S. defense companies.

In addition, scores of major U.S. defense programs are 'black' or special access programs. This means that they are so highly classified that information about the program is compartmented, so that even the contemplated scope of work is unavailable to foreign firms. Projects on the scale of the B-2 bomber have been classified as entirely special access programs. By making a program 'black,' the DoD has, in effect—if not by intention—protected participating U.S. industry from unwanted foreign competition. During the Reagan Administration

spend-up, an unprecedented number of programs, and a large percentage of the acquisition budget, was dedicated to special access activities.

Beyond this, dozens of U.S. laws contain "buy American" provisions that are applicable to defense procurement.¹⁷ Although some buy American legislation can be waived on the authority of the Secretary of Defense, as is routinely done in country-specific, reciprocal memoranda of understanding, these provisions set a tone and preference that is adhered to by many DoD officials. Finally, there is a strong bias against foreign technology that stretches the length of the chain from the Services, though the Office of the Secretary of Defense up to Congress and back. In addition, many DoD officials hold the view that foreign defense technology is inferior to that produced in the United States. The overall effect is that most U.S. defense work is done by companies owned and operated in the United States, and that the various mechanisms for international collaboration form an exception to the rule.

Finally, under mobilization base rules, DoD may restrict a procurement to the North American industrial base if it finds that the product or component in question is necessary to sustaining critical U.S. production capabilities in times of crisis or conflict. In practical terms, foreign companies have *come to believe that they* must locate facilities in North America in order to sell to DoD, although a mix of off-shore and on-shore production is often sought as a compromise.

A variety of U.S. laws and regulations create de facto separation of the defense and civil industrial and technology bases in the United States. In general, companies in the upper and middle tiers of the defense industries do most of their business with defense customers, domestic and foreign. This situation did not arise because executives made a decision to be in defense work and to reject nondefense opportunities. It occurs because U.S. laws, DoD regulations, and auditing procedures virtually require that a company organize itself to do nothing but defense work, and do it in ways that are not cost-effective in the civilian sector.

The fact that many U.S. defense companies depend on defense contracts for most or all of their business makes them more vulnerable to defense downturns than the competition in Europe and

¹⁷See U.S. Department of Defense, "The Impact of Buy American Restrictions Affecting Defense Procurement," July 1989.

Japan, where defense and nondefense work is more often and more easily integrated into a single corporate structure. Suppose, for example, that defense production is reduced by 50 percent, both in the United States and in Japan. A U.S. company that conducts 85 percent of its business in defense might be forced to close its doors. Its Japanese counterpart, that depends on defense work for only 10 percent of its business, would be able to absorb the cuts far more easily. In addition, because it combines civilian and defense operations under a single administrative roof, the Japanese company may be better positioned to convert its defense manufacturing to production for civilian purposes. As Congress grapples with the question of converting the defense industries to nondefense operation, it may be necessary to begin by eliminating the legal and administrative impediments to conversion.

POLICY ISSUES FOR THE 1990s

If Congress can make defense industrial policies, Congress can also change them. If the policies that created the structure of the defense industries and control international collaboration in defense technology are inadequate or irrelevant to today's circumstances, Congress can revise them. Congress faces an unprecedented situation and a unique opportunity in trying to ensure the future national security of the United States. Many aspects of today's defense policies, particularly those that affect international collaboration, are inadequate or counterproductive. Consequently, Congress will have to address a number of difficult policy choices, if it is to be a major player in the adjustment and restructuring of the defense industries.

In this, as in so many areas, Congress finds itself between a rock and a hard place. Many analysts will urge caution because so much uncertainty exists as to the nature of future military threats, the successor failure of *perestroika*, and the affect of German reunification on East-West relations and the economic integration of Europe. They would stay the hand of Congress until more is known.

Alternatively, if Congress fails to act, the defense companies will move to restructure their domestic and international operations in response to economic forces. Many large defense companies are now for sale, but as yet there are few takers. As budgets fall, companies that are able to get out of the defense business may do just that, leaving behind the less

capable that have few options. Accordingly, the United States may end up with a defense industrial structure unable to meet the future defense needs of the Nation.

Revamping the Defense Industrial Base

The first two issues relate to basic structural flaws in the organization and operations of the U.S. defense industrial sector. In a time of plenty, when U.S. defense technology was preeminent throughout the world, large scale inefficiencies, such as the separation of defense and nondefense manufacturing infrastructure, and the protection of defense industry, could be sustained. This is much less true today, and will soon present an acute problem to Congress, as demand for defense equipment dwindles, and competition among the defense industrial and technological centers of the world drives many firms out of the defense business.

Issue 1: Protecting the Defense Industries

U.S. policy has been to protect the defense sector from most forms of international competition. So long as the defense industries were strong in the United States, and there was little competition from abroad, the degree of protection was not a significant issue, except to our Allies who complained that the "two-way street" in NATO armaments cooperation was a superhighway to Europe with a dirt road back. In recent years, however, direct cooperation between U.S. and foreign companies has increased international exchange and commerce in defense technology. Moreover, the environment of defense technology has changed so significantly in the past decade, and promises to change even more radically over the next few years, that the fate of the defense industries, both here and abroad, is uncertain.

In the context of diminishing defense dollars and worldwide overcapacity, demands that Congress do something to assist the domestic defense industry are certain to mount, particularly as congressional districts register the impact of increased international competition and decreased production, and most directly when plants close and jobs evaporate.

These demands will be difficult to resist, and will emanate from different sectors of the defense industry. They are likely to defy panacean remedies, and will probably create conflicting initiatives within the executive branch. The large companies will lobby for increased internationalization of the

defense industry, so that they can have freedom and flexibility to enter into deals that make money, irrespective of the impact on the domestic industrial base. Thus, they will ask for relaxation of technology security controls, and for policies that promote greater access to foreign markets.

On the other hand, many of the smaller, middle-tier subcontractors would likely view increased internationalization and openness in the U.S. defense market as a disaster. Many believe they will lose subcontracts to large foreign firms, who will work with their own supplier bases, and there will be far less business in the United States. Foreign governments and defense firms would of course demand reciprocal penetration of the U.S. market, and the ability to sell U.S.-origin technology and components to third country arms markets.

As Congress moves toward reauthorization of the Defense Production Act, and proposes related legislation to support the U.S. defense industrial capacity, it will have to balance the need to retain a strong defense industry at home against the increasingly internationalized character of large U.S. companies, defense technology, and defense markets. There is concern in many quarters that the defense industrial base in the United States is eroding quickly, although the data that supports this thesis is weak, and there is a movement in Congress to do something about it. One prominent approach is to define what a U.S. company is, and then to create preferential treatment for U.S. companies through a variety of mechanisms.

It is extremely difficult, however, to define what a U.S. company is in a way that supports domestic R&D and production of defense materiel without: 1) excluding a great many capable firms (both defense and civilian) already producing in the United States, and 2) damaging the international business and profitability of the largest U.S. defense companies that are committed to international business relationships with foreign companies. It would be ironic, indeed, if policy frees aimed at strengthening the defense industrial sector led to the collapse of the international business of large U.S. defense companies.

The policy dilemma here is that the interests of different sectors of the defense industries can easily be pitted one against the other. A prudent strategy would encourage a strong domestic defense industrial structure and, at the same time, recognize that

international business cooperation in defense has become a very important element in the overall picture. Beyond a doubt, the actions that Congress takes in this area will become increasingly important as the defense industries restructure their operations in response to anticipated budget declines. Ultimately, a sound policy will assist in managing the transition of the defense industrial base to a lower level of defense activity and into productive civilian enterprises.

Autarkic policy fixes are likely to exacerbate the problem. Rigorous enforcement of buy-American legislation, a surcharge on foreign-produced defense materiel, or a blanket requirement to tighten protection over a 5-year period would likely hold undesirable consequences for the U.S. defense community and for international relations. First, it would decrease U.S. access to advanced foreign defense technology. Second, it would weaken the incentive for some U.S. defense companies to stay at the leading edge (and might increase costs) because companies would have a guaranteed market. Moreover, with reduced competition, there would be even less incentive to modernize plants. And finally, increased domestic protection would engender reciprocal protectionism abroad, with the result of sharply decreased profits for the largest U.S. defense aerospace and electronics industries.

On the other hand, a policy that opened the U.S. defense market, relaxed technology security controls, and encouraged international collaboration would create stiffer competition for the smaller and middle-tier defense companies. In addition, in the context of a general reduction in Western defense budgets, opening markets might also create vulnerabilities for some of the largest U.S. defense companies, particularly those that have recently posted poor earnings, are now for sale, or teetering on the verge of bankruptcy. In the increased competition that would result from such a policy, structural overcapacity in many vital sectors of the U.S. defense industries might lead to the closing of major divisions or companies, probably starting in the aerospace sector, where competition for limited business is already intense.

Clearly, expected contraction of the defense industries places Congress in a delicate position, where conflicting demands of powerful interests must be balanced against the national security. Accordingly, when Congress debates new measures

to support the defense industries, or to convert defense production to civilian purposes, a first order issue will be the need to develop a strategy that defines an acceptable level of defense R&D and industrial capacity, that must be maintained in the United States. Cost will be an increasingly important factor. Part of this analysis would focus on how to achieve a more integrated approach to civil and defense manufacturing, with the recognition that a great deal of technology for future defense systems will be designed, developed and even produced in the commercial, nondefense sector.

Issue 2: Integrating Defense and Civil Manufacturing

A large number of studies and high-level reports have called for reform of the acquisition system that DoD uses to procure defense goods and weapons. They have cited continuous cost overruns, spare parts horror stories, a lack of open competition, interservice rivalries and duplication of weapons systems. Such reports and attempts at reform have caused confusion and consternation within the defense industrial sector, but have generally failed to make defense procurement either more efficient or less expensive. There continues to be the perception that the more Congress tries to fix the system, the worse it seems to get.

As OTA previously reported, many of the rules and regulations that make defense industry inefficient and cumbersome were motivated by conscientious lawmakers and officials who sought to protect the public interest, and to eradicate fraud and abuse in matters relating to public funds. But the cumulative effect of regulatory controls is that the vast bureaucratic overhead of government has been extended into and replicated within the defense industry itself. These rules and regulations have created substantial barriers between the defense and civilian industrial sectors.¹⁸

One result is that much potentially useful R&D and productive capacity in the civil sector has been decoupled from defense, probably to the detriment of both sectors. Among advanced industrial nations, the United States is the most extreme in the separation of defense R&D and manufacturing infrastructure from the larger civilian economy. Both in Europe and in Japan, companies that build

defense systems have large scale civilian operations as well. For this reason, they are better positioned to take advantage of dual-use technology than are the more highly defense-oriented companies in the United States.

In the United States, several of the largest defense prime contractors are wholly owned subsidiaries of civilian companies. In discussions with these firms, OTA staff were told that defense and civil divisions do not share accounting, financial, personnel, or other management systems, and in most cases, they cannot even share technology. In one corporation, the company makes satellites both for the military and for civilian customers. Even where the mission of the satellites is similar, the two divisions do not share data, technology, personnel, R&D or manufacturing facilities.

Defense companies tend to focus on meeting government requirements and have had little incentive to stay at the leading edge of manufacturing technology. They have been able to do so only because they are supported by government. If a civilian industry falls behind in technology innovation or in manufacturing technology, it will soon be supplanted by foreign competition. On the other hand, most civilian companies do not know how to meet all the requirements in the defense world. To qualify and conduct business with DoD or its prime contractors, civilian firms would be forced to reorganize all phases of operations to meet government regulations and specifications. The result is that legal and administrative requirements have built rigid barriers between the civil and military sectors of the economy, forcing DoD to maintain separate corporate and manufacturing infrastructures dedicated to defense.

This way of doing business runs counter to world trends in R&D and manufacturing, where technology is increasingly viewed as generic or dual-use, and then is applied to military or civilian purposes. In many Japanese and European companies, technology developed for consumer markets is modified and then applied to military systems. In order to implement this kind of technology path in the United States, it would first be necessary to change the way the defense business is conducted in fundamental ways.

¹⁸*Holding the Edge*, op. cit., footnote 4. See ch. 9 and *passim*.

Congress faces a situation where radical action may be necessary because most of the quick fixes (and some hard solutions) have been tried and have failed. But recent and ongoing changes in world politics and in the global environment of defense technology now offer opportunities that may not have been available in the past. This Congress and the next will have to choose between managing the down-sizing of the defense industrial sector or letting it be dismantled piecemeal in corporate board rooms by managers seeking to cut their losses and get out of the defense business.¹⁹ Clearly this is an uncomfortable debate involving political risks to members on one hand and risk to the security of the Nation on the other.

But it is precisely this environment that creates the opportunity and the forum in which to question seriously the necessity for maintaining a separate and highly inefficient R&D and manufacturing infrastructure dedicated to defense.

The Role of Government in Defense Industrial Cooperation

A second set of issues is closely related to the first. It focuses on the appropriate conduct of government as regards the international activities of the largest defense corporations and the middle-tier companies that support them. The present policy framework is inconsistent because, at one and the same time, it promotes internationalization of U.S. industry, hinders its operations and opportunities, and attempts to protect the domestic market from significant or unwanted foreign competition.

Issue 3: Globalization of the Defense Industries

The largest defense companies are not global in the sense that the largest commercial multinational corporations are. Governments, by tradition and of necessity, exert far stronger controls over the business decisions and prospects of the defense companies. This is true even when a large defense firm is wholly owned by a commercial conglomerate. Most large defense companies have only recently learned to go beyond foreign military sales, and to collaborate on an international scale. They have retained the major portion of their R&D and manufacturing facilities within the continental United States. While the largest defense companies increasingly enter into codevelopment, coproduction, joint ventures,

and strategic alliances with foreign firms, most are U.S.-owned and operated, and they are subject to extensive regulation by the U.S. Government.

Nevertheless, the distinction between an international company and a global one is largely a matter of degree. The policy problem centers on how to regulate sales abroad of U.S.-made weapons in the presence of an international or global arms industry. For example, intense lobbying pressure will be focused on Congress to relax foreign policy controls on sales of weapons to Third World countries. These controls are used to limit both the kind of technology that can be exported or transferred, and to designate countries that may or may not receive U.S.-origin defense materiel.

During the 1990s, as Western Europe and Japan become better able to satisfy their own defense needs, sales of military equipment and related technology transfer to Third World nations will be an increasingly important issue. As Third World conflicts go high-tech, U.S. defense contractors (and the European competition) will seek to expand foreign sales as a means of balancing reduced sales at home. (See figures 2-3 and 2-4 on arms imports and exports.) The risks associated with these sales and transfers are greater because these countries are more independent and less aligned to U.S. interests than the countries that were the recipients of U.S. equipment and technology transfer in the 1970s. Clearly, the task of deciding which militarily relevant technologies may be sold to which countries is an inherently governmental function. A policy that permitted the sale of defense technology to the highest bidder, without regard to nonproliferation, arms control, or to other foreign policy considerations, would increase sales for the defense industries. Indeed, many defense executives believe that they have lost sales to foreign competitors due to overly restrictive, unilateral U.S. controls.

As the U.S. defense giants become increasingly international in scope and operations, Congress will have to decide what controls can and should be maintained and/or imposed on them. This will require a delicate balance, particularly with regard to the European powers that are now consolidating and concentrating their arms industries, partly to obtain economies of scale and partly in response to the overall economic integration of Europe pursuant to the Single European Act. It is unlikely that U.S.

¹⁹The recent decision of the Ford Motor Co. to divest itself of defense assets should be considered closely in this regard.

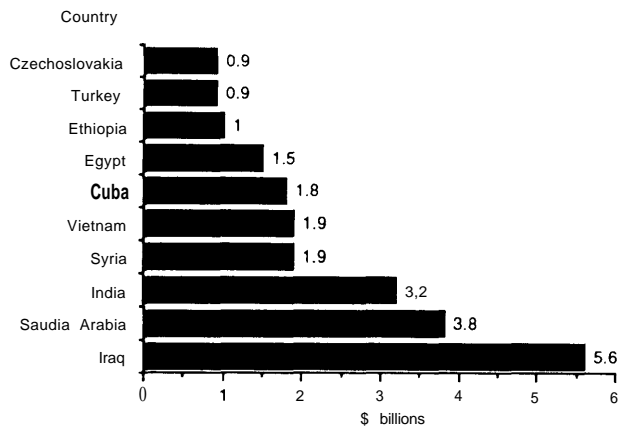
Figure 2-3-Leading Arms Importers, 1987

SOURCE: Data from Arms Control and Disarmament Agency, 1988.

allies, who have always paid more attention to the economic aspects of armaments cooperation, will be anxious to increase controls over the sales of their national or regional arms industries as world demand for defense commodities diminishes.

Issue 4: The Appropriate Level of Defense Technology

The Cold War engendered apolitical and military stability in the West unknown throughout the first half of the 20th century. Even if many in Congress felt that the arms race was a dangerous and extravagant proposition, they could not deny that the stand-off between NATO and the Warsaw Pact had brought peace to all of Europe for more than 40 years and prosperity to the West. At this writing, with the nations of the Warsaw Treaty Organization in political disarray, and tens of thousands of protesters demanding democracy in the streets of Moscow, much is uncertain. At a minimum, the consensus on the Soviet threat that supported high levels of defense spending, as well as collaboration in defense technology between the United States and its allies in Europe, has begun to unravel.

Congress and the Administration face a new political environment and new economic challenges as they begin to address the amount and kinds of defense technology and systems that are necessary to ensure the future military security of the United States and its allies. In the Cold War era, a principal

strategy of the U.S. armed forces was to counter superior numbers of men and equipment with superior technology. This meant that military planners generally sought to use state-of-the-art technology, and even to push the leading edge farther out by incorporating anticipated innovations into future weapons systems. The amount of effort needed and the bottom line became secondary considerations. One result was a never-ending competition in the development and production of armaments between the United States and the Soviet Union. Another was a constant upward pressure on the defense budget as the costs of high-performance, high-technology systems escalated.²⁰

An agreement, in principle, to reduce and limit U.S. and Soviet troop levels in Europe has recently been reached,²¹ and subsequent agreements to reach parity in conventional armaments are now being negotiated in Vienna. It is now at least conceivable that the nature and extent of the preparations to meet the Soviet threat will be determined in the future not by an arms race, but by arms control and verification regimes that designate the numbers and kinds of systems to be built and deployed by the United States, the Soviet Union, and their respective allies. This would, of course, exert a profound influence on international collaboration in defense technology, because it would create a new set of governmentally imposed constraints on the defense industries.

As Congress considers the nature of the military capability that will be necessary in the future, the issue of the technical sophistication of forces, units, weapons systems, and equipment, and the associated costs, will become increasingly important. Congress may wish to reconsider the underlying strategy that calls for designing next generation and even notional technologies into weapons systems. As noted earlier, these tend to be military-specific in character, with few or no civilian applications. It is possible that large scale substitution of dual-use for military-specific technologies might ultimately undermine the position of the United States as a military superpower—because dual-use technologies would be available to many nations. In time, the U.S. military position might degenerate to the status of first among equals.

²⁰Some analysts argue that technological complexity is also a factor both in rising costs and in the lengthening time it takes to get new weapons into the field.

²¹The Soviet Union and the United States have agreed to limit troop strength in central Europe to 195,000 on each side, with the United States permitted to maintain an additional 30,000 troops in other parts of Europe. *New York Times*, Feb. 14, 1990, p. A-1.

Figure 2-4-Arms Exports, Cumulative Sales, 1977-87

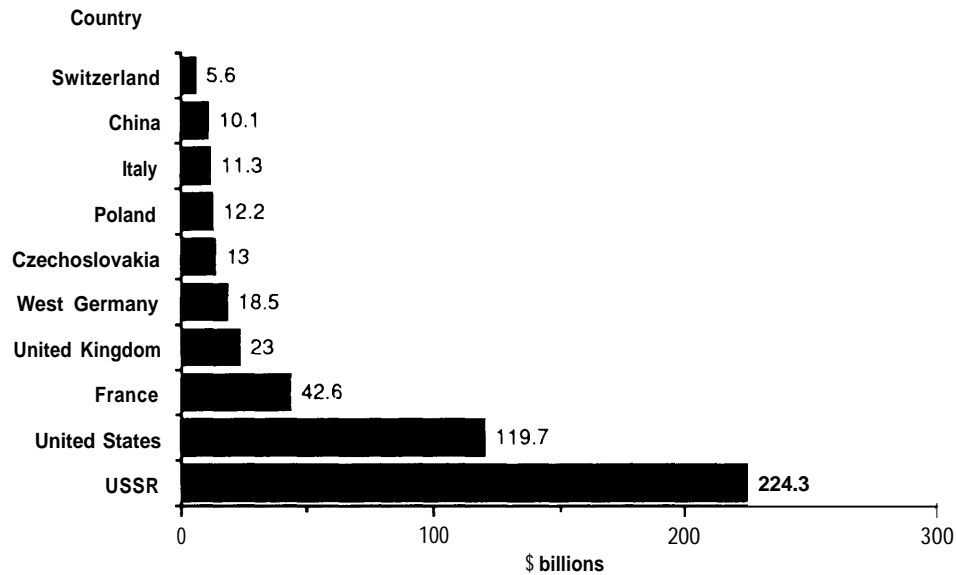

SOURCE: Data from Arm Control and Disarmament Agency, 1988.

Nevertheless, Congress will likely experience unrelenting pressure to get on with the business of peace, to collect the “peace dividend,” and to reorient defense spending to reduce budget deficits and to meet pressing social service, environmental, and other domestic needs that have been neglected over the past decade.

Issue 5: Military Dependence on Foreign Technology

In the long run international collaboration in defense technology generates dependence. This is obviously the case in direct offset agreements, where a foreign coproducer of a weapons system may demand and receive the right to supply a particular part or component for all future copies of a given system. The original developer of the system would have little reason to retain such a capacity when rights to produce it have been given to a foreign supplier. For many years, DoD has avoided involvement in offsets, but to little effect, because offsets have become just one more trading chit that may be necessary for a U.S. firm to clinch an international deal. Beyond offsets, most forms of international collaboration contribute to the dispersion of technical capacity, and ultimately to dependence, if for no other reason than the U.S. company draws on the technical expertise of its foreign partners to build the part, component, or system in question.

A second kind of dependence arises in the context of dual-use technology, and the global structure of the civilian industries whose technology ultimately ends up defense systems. As discussed previously, these are the companies about which the U.S. Government knows the least, but through which much dependence has been introduced into defense systems. OTA made substantial efforts to obtain quantitative data regarding the amount of foreign content in U.S. weapons systems. The government does not maintain such data, because there is no audit trail that penetrates much below the level of the second tier contractors. OTA also approached several large prime contractors and was told that they do not provide data on foreign content in specific systems because they have no mechanism to capture it. Several stated that it would be a very costly and difficult task, and that it would not be possible to track the country of origin for many parts and components.

The debate over military dependence on foreign technology is often stated in terms of its potentially detrimental impact on the ability to mobilize for a prolonged war. But like many other defense issues, foreign dependence must be cast in new terms, given changes in the environment of defense technology, and recent dramatic movement in political and military relations between East and West. Logically,

it makes sense to worry about military dependence on foreign technology when such dependence poses a military threat, and when a nation is in a position to do something about it. For decades, the European powers depended on U.S. defense technology in a way that is unacceptable and unthinkable to most Americans. Rather than posing a threat to the Europeans, military dependence on the United States both enhanced European security in the near term, and became a means of acquiring technology that could be used to rebuild their industrial bases. Over time, the Europeans have been able to decrease their dependence on the United States substantially. Using U.S. technology as a base, they learned to build systems at home, systems that usually cost more and were somewhat less capable than systems available through U.S. foreign military sales programs.

The European experience teaches that there may be some kinds of foreign dependence that can be tolerated more easily than others. This distinction underlies the present effort in Congress and elsewhere to identify technologies that are critical to the military. It is closely associated with the argument that a nation must retain R&D and industrial capacity in certain essential technologies in order to maintain its international trade position, and ultimately the standard of living of its population. The military and civilian threads of this argument are, of course, joined in the notion of dual-use technologies, which in many cases, turn out to be critical technologies both in defending the territorial integrity of a nation and in maintaining its economic vitality.

This is also the point where the relationship between economic well-being and national security becomes transparent. In the long term, it is unlikely that the United States will be able to ensure its future military security if it cannot compete in civilian markets, markets that produce both the wealth necessary to fund the common defense and, increasingly, the wealth necessary to conduct the R&D and manufacture of future critical dual-use technologies.

If Congress decides to address the question of military dependence on foreign technology, it will first be necessary to collect data or to establish some measures of the extent and exact nature of the phenomenon in question. It will then be appropriate to decide how much and what kinds of dependence can be tolerated. The other way to approach the problem is, as suggested above, to define critical technological and industrial sectors that must be maintained in the United States, both for economic and for military reasons, and to take steps to ensure that they are supported.

Issue 6: Technology Transfer and Security Restrictions

Throughout the 1980s, DoD pursued a conservative policy regarding transfer of militarily relevant technologies to foreign governments and companies.²² It was based on the assumption that the Soviet Union and its Warsaw Pact allies seek to acquire Western technology to aid them in developing modern weapons and systems, from every possible source, using all available means. This assumption appears less well-grounded today in light of the political dissolution of the Warsaw Pact, and political and economic changes sweeping the Soviet Union.²³

At this writing the Bush Administration is contemplating major policy changes in the administration of export controls, both for militarily critical and dual-use technologies. The President has ordered a national security review, to be carried out by the Joint Chiefs of Staff and by the intelligence community. There is strong pressure from the U.S. business community and from the Coordinating Committee (COCOM)²⁴ nations to relax controls on technology to Eastern Europe. The U.S. strategy appears to be to reach agreement on a small number of technologies that must be controlled, and then rigorously enforce that regime. Some DoD officials have expressed concern over this plan because they believe that the intelligence services of the Eastern European nations are still intact and in full communication with their Soviet counterparts.

²²Both DoD and the Department of Commerce implement initiatives to convince the NATO Allies to tighten export restrictions on technology. They pressed for stronger administrative controls, and for expansion of the powers of the Paris-based Coordinating Committee (COCOM). The policy objective was to stem what some DoD officials described as a hemorrhage of Western technology flowing to the East.

²³Technology security policy has been the subject of considerable debate since 1987, when a National Academy of Sciences panel on national security export controls, chaired by former U.S. Air Force Chief of Staff **Lew Allen**, issued a report sharply critical of U.S. export administration policy and practices and recommended sweeping changes in the export control process. *Balancing the National Interest: U.S. National Security Export Controls and Global Economic Competition* (Washington, DC: National Academy Press, 1987).

²⁴COCOM is a voluntary body which oversees East-West trade to ensure that Soviet and Warsaw Pact military power is not aided by this trade.

Congress will soon address the next reauthorization of the Export Administration Act (EAA), part of the current legislative authority for U.S. export controls. The EAA, which has twice been amended since its passage in 1979, is set to expire on September 30, 1990. As Congress considers this legislation, it will be necessary to determine whether the statute remains adequate in the face of recent developments and can therefore be retained or amended without fundamental changes; or whether substantially new policies are required to meet changing technological, political, and economic circumstances.

As written and administered today, export controls over technology constitute a de facto and unintended policy to regulate the kinds and amount of international collaboration that U.S. defense companies may engage in. They have also inhibited the international business prospects of U.S. civilian companies because U.S. unilateral restrictions and interpretations of COCOM rules are more strict than those of other COCOM nations. Congress may decide to limit the international activities of U.S. defense companies, but if it does, it should do so purposefully, and not as a side effect of other policy goals.

Obtaining an export license for an item covered by the Arms Export Control Act, which controls militarily critical technologies, is a lengthy process. All license applications must be submitted to the Office of Munitions Control at the State Department. In DoD, the Defense Technology Security Administration (DTSA) coordinates applications with the Armed Services and defense agencies. While DTSA tries to move applications rapidly through the system, the sheer number, and multiple levels of review, inevitably cause delays. Most large U.S. defense contractors argue that DoD's technology transfer policies are biased toward protection, rather than sharing, and taken together, constitute a major impediment to successful industry-to-industry cooperation.

The issue of third country re-export restrictions is particularly sensitive. When the U.S. Government grants a license to a U.S. firm to export defense or

dual-use products, the receiving government or company must agree to request permission from the United States before it re-exports that product (in any form) to a third country. This restriction is applicable under the Arms Export Control Act and under some provisions of the Export Administration Act. Third-country restrictions have been a source of irritation to allied governments and foreign companies that were forced to accept them when no other source offered the product or the underlying technology. Many large U.S. defense contractors report, however, that foreign governments and their industries increasingly seek non-U.S. sources for weapon systems which have export potential in order to circumvent restrictive U.S. Government policies.

In recent years, the defense industries, the Defense Science Board, the National Academy of Sciences, and the Defense Policy Advisory Committee on Trade, among others, have raised technology transfer policy as a primary issue, and have called for a relaxation in the policy as a means to assist international sales of defense companies, and to make civilian, high-technology companies more competitive. In addition to the ongoing executive review of export controls, the National Academy of Sciences in conducting a follow-on study to its influential 1987 report, *Balancing the National Interest*.

A new policy on export controls will have to balance the economic concerns of U.S. companies against U.S. foreign policy goals such as arms control and nonproliferation of weapons of mass destruction. In this regard, it may be necessary to tighten controls on some strictly military technologies, and at the same time, establish a mechanism to remove controls that damage the competitiveness of U.S. industry. Such a policy will clearly have to be sensitive to the differences among various allies, as well as differences between Eastern and Western Europe, and between Eastern Europe and the Soviet Union.

Chapter 3

European Policies in Perspective

CONTENTS

	<i>Page</i>
HISTORICAL PERSPECTIVE NATO PARTNERSHIP AND NATIONAL INTERESTS	41
The Spectrum of Alliance Weapons Cooperation	41
The Case for Cooperation in Defense Technology	44
Collaboration and National Interests	44
The Post-War Context	46
The Forces for Change	50
CURRENT EUROPEAN PERSPECTIVES ON THE DEFENSE MARKET	53
Overcapacity and Transatlantic Competition	53
The Quest for Integration	54
Current Policies of Key European Governments	56

Boxes

	<i>Page</i>
3-A. Forms of Collaboration	45
3-B. Defense Collaboration in NATO Europe	50
3-C. Defense Collaboration in Non-NATO Europe	52
3-D. Defense collaboration in Israel and the Middle East	55
3-E. Defense Collaboration With Canada	57

Figures

	<i>Page</i>
3-1. F-16 Coproduction Component Breakdown	42
3-2. Military Expenditures as Percent of Gross Domestic Product (GDP)	47
3-3. Organizations of Allied Defense Collaboration	51

HISTORICAL PERSPECTIVE: NATO PARTNERSHIP AND NATIONAL INTERESTS

The Spectrum of Alliance Weapons Cooperation

The central focus of U.S. defense policy toward Western Europe since the end of World War II has been the preservation and strengthening of the NATO Alliance. As this report is being prepared, events of unprecedented magnitude are unfolding in Eastern Europe that will profoundly affect the post-World War II order and U.S. defense relationships with Europe. Within a period of less than a year, the leadership has changed in Poland, Hungary, East Germany, Bulgaria, and Romania, and movement towards democratic reform has escalated. All this has taken place with the toleration and perhaps even encouragement of the Soviet Union. The dismantling of the Berlin wall, a symbol of the 40-year division of Europe into two opposed ideological camps, has opened possibilities that would have seemed quixotic just a short time ago. These include dramatically altered economic and political relationships between East and West Germany, closer economic ties between Eastern and Western Europe and changes in the roles and perhaps membership in NATO and the Warsaw Pact. The meeting in December 1989 between President Bush and President Gorbachev at Malta has accelerated the negotiating schedule for a substantial reduction of U.S. and Soviet forces from central Europe. Events are now proceeding with a rapidity that is taxing the ability of governments to promulgate realistic and supportable policies in the area of international armaments cooperation.

A report such as this, which deals with the design, production, and replacement cycles of weapons systems that are measured in decades, certainly in some respects, will be overtaken by political events. It is premature now to speculate on how the situation in Eastern Europe will affect specific Western armaments decisions. However, as a general guideline, it seems warranted to assume that the political convulsions will be confined to Eastern Europe, and that Western reaction to these events will be

governed to a large extent by economic and social considerations having deep historical roots. Thus, despite the current ferment, extrapolations based on the underlying economic and technological forces that have shaped U.S. weapons relations with Western Europe may yet prove valid for a wide range of political outcomes. Perhaps, and most likely of all, will be an acceleration of the current trend away from transatlantic weapons relations based on alliance considerations to a straightforward commercial basis.

The ways in which members of a military alliance can meet weapons procurement needs range from autarchy, in which each member fulfills its requirements independently, to a variety of cooperative arrangements such as grants; direct sales; sales with offsets; complementary weapons production; licensing; and joint research, development, and production. While these different combinations are usually thought of as taking place within the context of intergovernmental agreements, other forms of collaboration do exist on the private sector level, with little or no direct governmental involvement.

U.S. relations with its European allies in weapons production have generally followed a progression up the collaborative scale. In the immediate post-war era, the United States provided weapons to the Allies on a sale basis through the Military Assistance and Foreign Military Sales programs. Beginning in the late 1950s, as the Europeans recovered their industrial capacities, the demand arose for coproduction of portions of U.S. weapons systems in Europe. Accordingly, the United States shifted from direct military sales to licensing, with the F-104 aircraft and the HAWK air defense system being the first major examples of coproduction. The largest coproduction program within NATO to date has been the F-16 fighter aircraft. This involves a complex multi-nation arrangement of joint production, sales, offsets, and sharing of third country markets—initially valued at \$2.8 billion (see figure 3-1 for the contribution of different nations). During the past decade, the United States has licensed or entered into government-to-government coproduction agreements with 17 countries, including 7 NATO members, with

Figure 3-1-F-16 Coproduction Component Breakdown

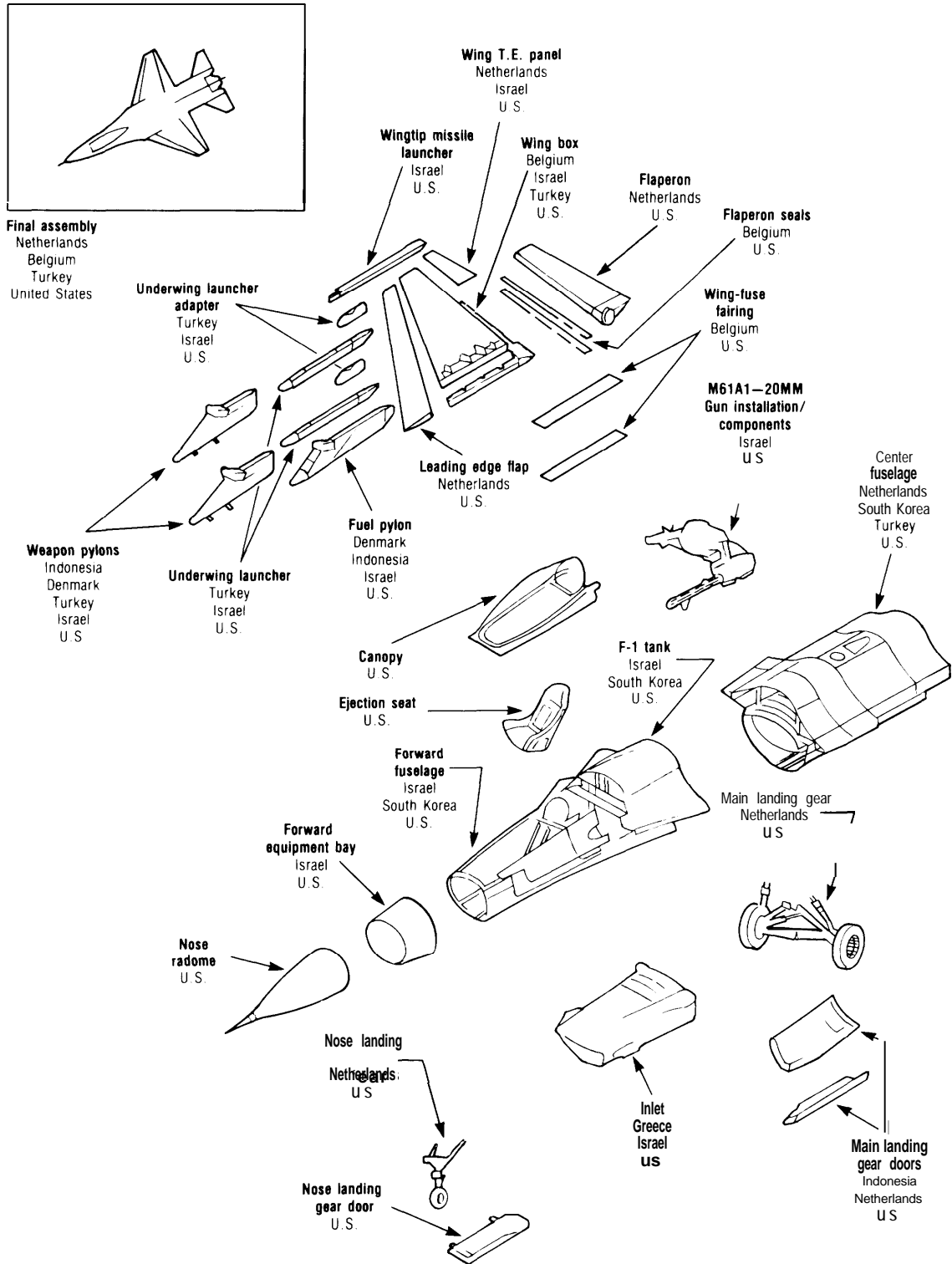

SOURCE: General Dynamics.

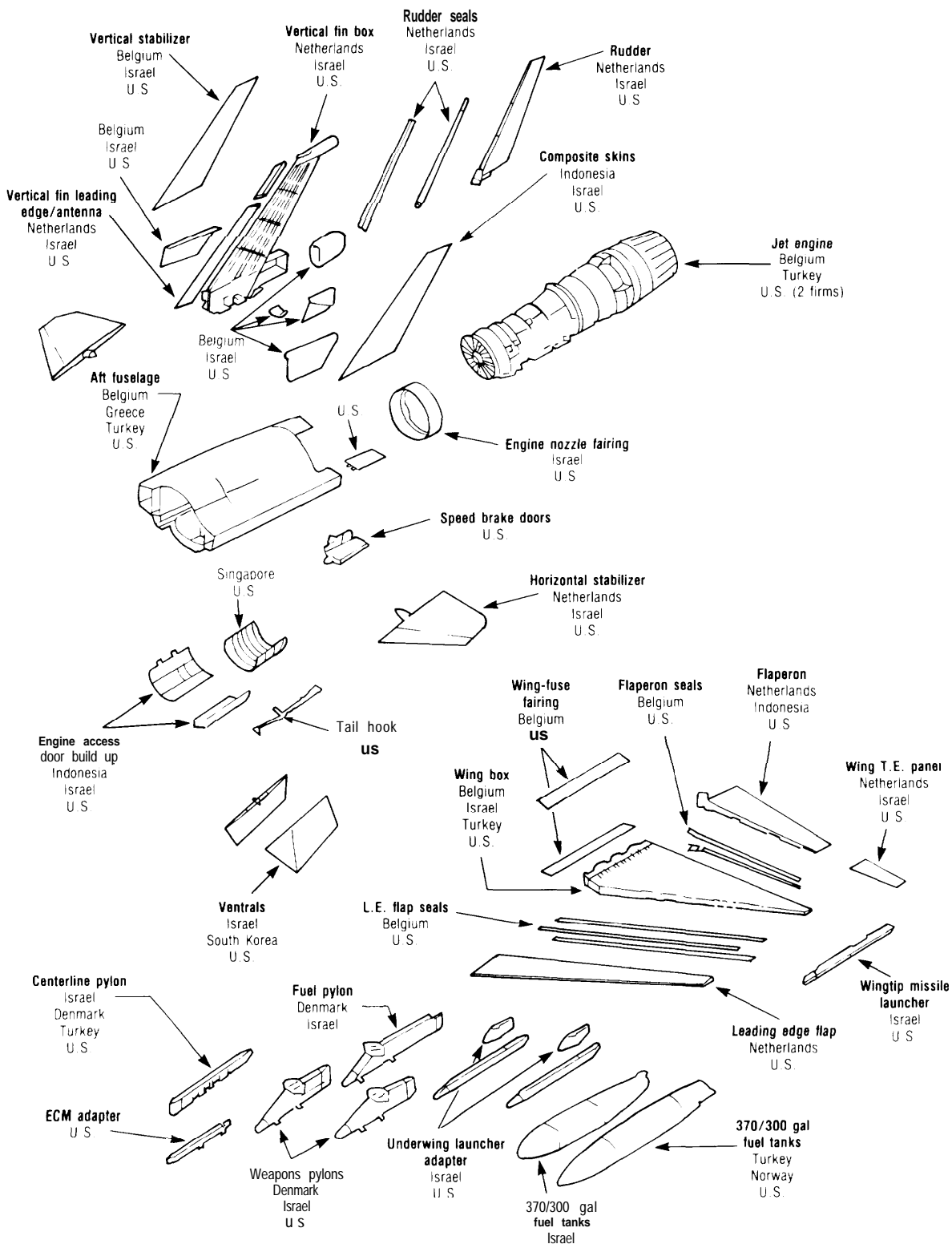

a total current estimated value of \$24.2 billion.¹ Appendixes B and C give a more detailed view of the modalities of collaboration.

As European scientific and technological capabilities reached U.S. levels, the emphasis has more recently shifted from coproduction to codevelopment, with the major collaborative impetus coming from industry rather than government. This is particularly true within Europe, where a significant proportion of major new weapons systems, such as the European Fighter Aircraft, now involve technology collaboration between two or more countries. U.S. Government interest in expanded transatlantic cooperation in defense technology R&D is evidenced by the 1986 Nunn-Roth-Warner amendment, although results to date indicate this is more difficult to arrange than intra-European collaboration.²

The Case for Cooperation in Defense Technology

European and American defense analysts have traditionally agreed about the desirability of increased cooperation in defense technology. The current disarray in the Warsaw Pact leads to a sharply reduced threat perception, while concurrently Western governments are under pressure to provide increased economic assistance to Eastern Europe. Both factors will tend to accelerate the decrease in Western defense spending. Yet, at the same time, the increasing sophistication of weapons systems demands ever higher investments in research and development. The resultant high per unit cost of weapons systems and consequently decreased ability of NATO governments to purchase sufficient numbers to meet projected forces requirements, risks so-called "structural disarmament. Collaboration provides one answer to this dilemma in theory by reducing duplicative R&D and achieving economies of scale through longer production runs. It also provides for a more robust and **cost-effective Alliance** defense through standardization and improved interoperability. This, of course, presents the argument in a somewhat idealized form.

NATO collaborative projects have generally required lengthy negotiations and complex management systems, which increase costs in relation to the number of participating countries. While there is no established, accurate method of matching collaborative costs against savings resulting from elimination of duplication of weapons systems, the assumption that cooperation provides the greater overall benefit has rarely been challenged.

In actual practice, however, the NATO Alliance has fallen far short of this ideal. For political and economic reasons the United States and, to varying degrees, Germany, the United Kingdom, and France, have usually practiced autonomous weapons systems development. The resultant duplication of effort and nonstandardization of **even** such basic items as fuel and ammunition is widely decried by defense experts and has significantly reduced NATO weapons deployments. Nevertheless, duplication does not appear to be diminishing. A recent survey of U.S. and European weapons systems under development identifies, for example, 16 U.S. and 26 European tactical aircraft, 33 U.S. and 38 European **tactical missiles**, and 18 U.S. and 20 European helicopters.³

For the smaller NATO countries, which lack the technological infrastructure to **produce entire weapons systems**, the options are limited to direct purchase or coproduction arrangements. Coproduction usually results in much higher per unit costs; however, the desire to provide for domestic employment, protect trade balances, and other nondefense considerations usually lead these countries to prefer it to direct purchases.

Collaboration and National Interests

Collaboration in defense technology, as opposed to licensing or coproduction arrangements, should be a more effective form of weapons cooperation between the United States and its NATO allies of roughly equal technological capabilities, since collaboration shares **costs** and reduces duplication. It is

¹The totals from fiscal years 1977 through 1988 for the NATO countries are: German y-\$4,309 million; Greece—\$199 million; Italy-\$71 million; Spain-\$578 million; Turkey—\$0.3 million; and U.K.-\$ 1,550 million. Source: Defense Security Assistance Agency.

²European reluctance to enter into technology collaboration with the United States is not a new phenomenon. For example, a 1980 study on NATO tactical missile **programs** indicates that the Europeans will accept elaboration with the United States only if it: a) is based on European participation as an equal **partner**; b) does not interfere with **intra-European cooperation**; c) involves increased **direct** purchase by the United States of European systems, or at least adoption by the United States of such systems through the use of licenses; and d) does not interfere with sales to third countries. Herschel E. Kanter and Joh N. Fry, *Cooperation in Development and Production of NATO Weapons* (Alexandria, VA: Institute for Defense Analyses, December 1980), p. S-9.

³"Status of Major U.S., European Defense, Aerospace Programs," *Aviation Week and Space Technology*, vol.132, No.12, Mar.19, 1990, pp. 20-37.

Forms of Collaboration

During the 1960s and 1970s, when the Foreign Military Sales (FMS) program was at its peak, U.S. industrial strategies for defense exports were simple: companies either manufactured equipment to be sold by the U.S. Government under the FMS program or they supported U.S. Government coproduction and licensed production policies on selected weapons systems. Through FMS programs, U.S. industry set up support teams in foreign countries to assist in installing, training, operating, and maintaining U.S.-origin equipment. In general, U.S. companies assisted foreign companies so that they could in turn support their own governments. These activities rarely led to lasting business relationships. It was in the commercial and space markets where U.S. and foreign companies began to establish a more equal basis for collaboration.

Throughout the 1980s, industry-to-industry collaboration grew in importance. The simplest form of industry-to-industry collaboration is teaming. One company (usually based in the sponsoring country) serves as the lead and prime contractor. The other team members function as subcontractors who participate in the program in a predetermined way. Teaming is standard practice in the U.S. defense marketplace, and is used by prime contractors to lockup critical subcontracting resources during competitive bids. In fact, teaming is so widely used in the United States that defense contractors often find themselves on competing teams for one program and on the same team for another.

Most European companies have not favored program-by-program teaming. Instead, they have sought to establish long-term, management-level relationships with firms with complementary technologies, product lines, or markets, using these associations as a basis to pursue a range of similar market opportunities. This has led to an emphasis in Europe on formal strategic company-to-company agreements or alliances. This concept of banding together to pursue expensive and long-term development programs has become commonplace and a consortium or joint venture is often the formal mechanism.

Whereas a teaming agreement is a prime contractor-subcontractor relationship operating under existing corporate structures, a consortium usually assumes an organizational form of its own, often with a board of directors comprised of the member companies to oversee activities, a lead program manager, and integrated technical and support teams. Consortia can be directed toward multiple business opportunities or a single one. Several have been formed to pursue cooperative programs funded under the Nunn amendment.

A joint venture is a separate corporate entity established by the participating companies and operated as an independent body. Joint ventures represent a greater corporate resource commitment than simple teaming or consortia because the new company must be financed and helped to grow, over an extended period. While a joint-venture company may look to the parent companies for most resources, it can also go outside to acquire goods and services, which may be available on better terms. Joint ventures are almost always set up to pursue broad business areas, but their objectives and structures are flexible. These companies can concentrate on marketing, joint R&D activities or manufacturing, or a combination.

Until recently, banding together was relatively unfamiliar to U.S. industry. However, major U.S. companies are beginning to seek collaboration in key technologies. Much attention has been paid to SEMATECH, the DoD-industry consortium to develop microelectronic manufacturing technologies, although there are some earlier examples, such as the Electric Power Research Institute (EPRI), the Semiconductor Research Cooperative (SRS), the Council on Chemical Research, the University Steel Resources Center, and the Microelectronics and Computer Corp. (MCC). The trend toward collaboration on a national scale has been aided by a relaxed U.S. Government attitude regarding the anti-trust implications of joint ventures in advanced technology and by the obvious success of such ventures in Japan and Europe.

The ultimate joint venture is an acquisition or merger. Since the mid-1980s, an increasing number of U.S. defense and high-technology firms appear to have been acquired by foreign concerns. While Japanese investment in the United States has been closely watched, in fact, U.K. investments in the U.S. defense sector have been greater. As the pace of these acquisitions has increased, foreign ownership has become an increasingly important issue with Congress and with DoD.

On the other hand, U.S. companies have not moved as aggressively to acquire companies in Europe or in the Pacific Rim. This is in part because these governments historically restrict foreign takeovers of their defense and high-technology firms. Although cross-border mergers and acquisitions are becoming more commonplace in

continued on next page

Forms of Collaboration—continued

Europe pursuant to the Single European Act, takeovers by U.S. firms are still viewed with caution. U.S. acquisitions in Japan are even more difficult to achieve.

There are other barriers to foreign acquisitions by U.S. defense firms. For example, in such ventures the long view must be taken in terms of sales and profits, but U.S. companies seldom see individual foreign markets as sufficiently large to warrant tying up capital or taking undue financial risks. Consortia or joint ventures appear to be favored by U.S. companies to achieve a presence in foreign markets.

Depending on goals and market strategies, a company can use a variety of other techniques to facilitate industrial cooperation and increase exports. For mature products, for example, product licensing and cross-licensing techniques are common. In these a foreign firm is provided with a design and/or production package and the authority to produce and sell U.S.-developed products (or vice versa). Revenue sharing and technical assistance agreements are also used.

also the most difficult to arrange, because it impinges directly on the partners' defense, foreign policy, and economic interests. Collaboration is consequently easiest to initiate among nations whose broad interests are most nearly congruent.

U.S. alliance relationships with Europe can be envisioned as encompassing a range of mutual understandings. At the fundamental level, there is the common agreement that Western Europe should not fall under Soviet military domination. The durability of the NATO Alliance attests to the unquestioned transatlantic accord on this basic political purpose. On the next level is the issue of the direct economic costs of supporting the Alliance. Here there is considerably less agreement between the United States and Europe and, indeed, among the Europeans themselves. The "burdensharing" debate over what each member country should contribute has been a chronic problem for NATO, but has not caused a serious transatlantic rift. U.S. urging for increased European defense spending has never been rejected outright, but rather subsumed in promises by European Political leaders as goals to be achieved in the future. Further, some NATO countries, such as the United Kingdom and Turkey, actually do achieve percentages of gross national product (GNP) defense spending that approach that of the United States (see figure 3-2). At the third level is the issue of how overall economic policy relates to defense policy. Here the differences between Europe and the United States are the most pronounced. In this regard, unilateral U.S. economic

sanctions and trade policies have, at times, left the United States entirely isolated within NATO, creating suspicions that have never been fully resolved and creating a continuing residue of mutual suspicion.⁴

Added to the differences in policy comes the issue of the sheer size of defense outlays. U.S. annual spending on defense R&D, for example, equals the entire budget for the Bundeswehr. This disproportion has the effect in the United States of creating a high degree of insularity, while instilling in European governments and industry the feeling that they either must join forces or be swallowed by the U.S. defense industrial effort. It is therefore not surprising that collaborative programs in defense technology, which affect wide and sensitive sectors in each nation's economy, are advancing more rapidly among the Europeans than with the United States, despite the impetus of the Nunn-Roth Amendment. A further understanding of this phenomenon maybe found in comparing how differences in historical experience have shaped perceptions of national interest in the United States and in Europe, especially at the critical intersection of economic and defense policy.

The Post-War Context

United States

The United States emerged at the end of World War II as the world's preeminent military and industrial power. The United States was willing and able to give generous assistance, exemplified by the

⁴Examples include the 1979 declaration of U.S. economic sanctions against the Soviet Union following the invasion of Afghanistan, which the Europeans undercut with sales of agricultural and industrial goods, and European commencement of the the Siberian gas pipeline over U.S. objections, including unauthorized re-export of U.S. technology during the 1981-82 Polish crisis. For their part, the Europeans accused the United States of attempting to use sanctions to obtain commercial advantage.

Figure 3-2—Military Expenditures as Percent of Gross Domestic Product (GDP)

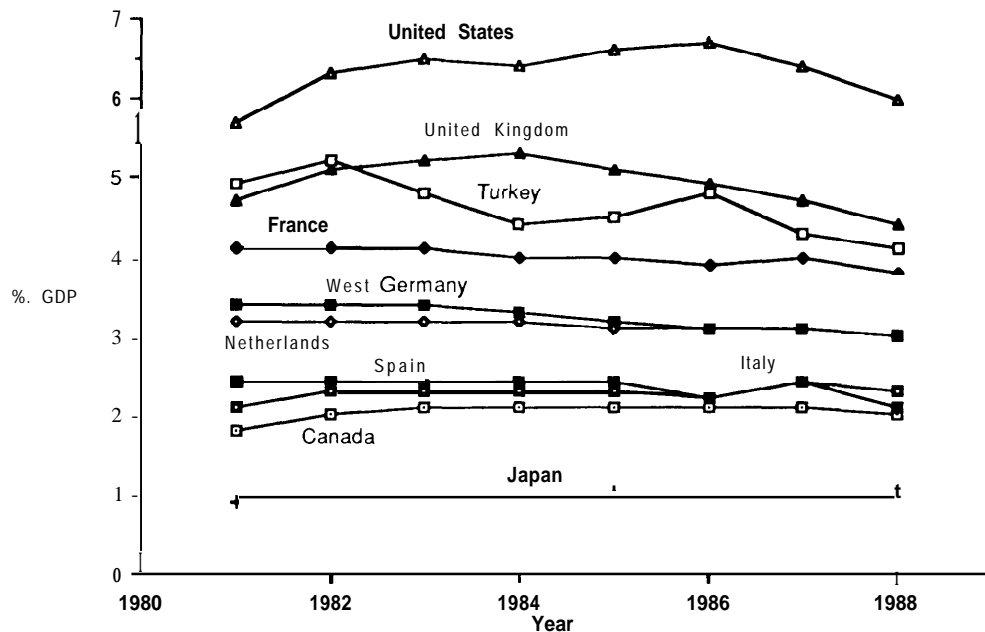

SOURCE: Data from Arms Control and Disarmament Agency, 1988.

Marshall Plan, to its European allies and former adversaries in helping to rebuild their war-ravaged economies and provide for their defense. At home, Americans perceived little need for government intervention in the civilian economic sphere beyond regulation and social welfare, and government-industry relations reverted in the United States to the distant and quasi-antagonistic pre-war posture. The major challenge the United States faced was the military threat posed by the Soviet Union, which refused to enter a post-war settlement and appeared to menace Western Europe and other regions. As a consequence, during the next 30 years, the United States fought two major wars and engaged in numerous smaller conflicts to combat the expansionism of the Soviets and their proxies and allies.

As a hegemonic power in the immediate post-World War II decades, the United States did not differentiate its economic and defense policies toward Europe. The United States considered European economic growth and steps toward economic integration both as good in themselves and as bolstering NATO defense capacities. As long as the

U.S. trade and fiscal situation remained reasonably balanced, the economic implications of U.S. defense commitments to Europe were of secondary importance. During this period, the United States sold weapons and weapons systems to its European partners at bargain prices, and readily acceded to European demands for coproduction and offset arrangements that reduced its balance of trade credits. It was not until the early 1980s, when the U.S. current account and manufacturing trade balances went into precipitous decline, that national attention focused on the economic side of the defense equation. Since then, there has been increasing concern that structural weaknesses in the U.S. manufacturing sector will undercut the maintenance of a first-class indigenous defense industry, and that the civilian economy and manufacturing base may be unable to support general governmental defense expenditures at current levels.⁵

The DoD is undertaking programs to support U.S. competitiveness in critical dual-use technologies such as Very High Speed Integrated Circuits and High Definition Television, yet many question

⁵See U.S. Congress, Office of Technology Assessment, *Holding the Edge: Maintaining the Defense Industrial Base*, OTA-ISC-420 (Washington, DC: U.S. Government Printing Office, April 1989); and U.S. Congress, Office of Technology Assessment, *Paying the Bill: Manufacturing & America's Trade Deficit*, OTA-ITE-390 (Washington DC: U.S. Government Printing Office, June 1988), for comprehensive discussions of the defense and civilian sector aspects of these issues.

whether defense R&D can or should continue to serve as a spur to the civilian economy. The need for increased U.S. export performance is universally accepted, but export control legislation considered disadvantageous to U.S. industry is allowed to remain on the books. The need to trim fiscal and current account deficits is likewise accepted, but the United States has not reduced significantly its foreign military commitments, including an estimated \$150 billion annual outlay for NATO.⁶ At present no consensus has formed to adjust national policies to current economic or political conditions.

Europe

World War II left the European industrial base in ruins. The European imperial powers, France and the United Kingdom, were stripped of their colonies. Germany, the major continental power, lost its eastern provinces and the remainder was divided between East and West. Collectively and individually there was neither the will nor the ability to project international political influence. Europe gladly accepted U.S. military protection and turned its full attention to the restoration of its economy. Government assistance and protection in the process of economic restoration were considered essential. Many industries were nationalized or otherwise established close ties to government. The Europeans recognized that intra-European cooperation was required for full economic recovery. The post-World War II history of Europe reveals a steady progression of economic cooperation from the European Coal and Steel Community, to the European Economic Community, to preparations for integration in 1992 under the Single Europe Act. European defense concerns remain substantially confined to the European continent.

The European approach to weapons procurement has been strongly influenced by economic considerations since the inception of NATO in 1949. Matters of domestic employment, export markets, civilian research and technology, and balance of payments have usually taken precedence over strictly defense concerns. The Europeans have been willing to pay a considerable premium in lessened defense capacity, or absorb higher costs, for the benefits of domestic production on the rationale that, as democracies, they would lose public support for defense efforts resulting in a net loss of employment. Thus,

beginning in the late 1950s, the Europeans have opted for coproduction arrangements rather than weapons purchases from the United States, have demanded offsets for what purchases they do make, and have initiated duplicative and competing weapons programs when they achieved the requisite technological capacity.

In distinction to the traditional U.S. attitude that European progress in the civilian economy and defense sectors is equally desirable and valuable, European attitudes vis-à-vis the United States have been more nuanced. In European eyes, the United States is seen as a strategic ally, but also as a formidable economic competitor whose dominance in NATO, if not opposed, could lead to permanent European technological inferiority. Even while the technology gap rapidly narrows, the Europeans still perceive that the United States will retain its competitive advantage in defense production due to the economies of scale afforded by its huge domestic market. This perception is the driving force behind the integration of national defense programs and the creation of intra-European strategic alliances in defense production. The Europeans are bolstered in this effort by their experience in government-sponsored cooperation with the Airbus and commercial space programs, which have made wide inroads into markets hitherto dominated by U.S. industry. The present situation requires that the Europeans balance carefully their economic and defense relationships with the United States, being sufficiently cooperative to deprive the United States of an excuse for a reduction of support for NATO, while at the same time pursuing common economic policies that are specifically designed to compete with U.S. interests.

NATO

At the founding of NATO, it was immediately apparent that economic and social conditions in Western Europe made it impossible to match the formidable Soviet advantage in conventional weapons. Defense policy and strategy thus centered on the threat of U.S. nuclear retaliation to deter a Soviet attack on NATO. The credibility of the U.S. strategic nuclear deterrent came under question when the Soviets achieved strategic nuclear parity. The NATO solution was the doctrine of "Flexible Response."

⁶See U.S. Congress, *House Armed Services Committee, Report of the Defense Burdensharing Panel, August 1988*, p.12.

The question of how much conventional defense is enough has been a continual matter of contention between the United States and the Europeans. The United States has consistently urged that NATO provide a conventional defense sufficient to deter a Soviet conventional attack while underlining the threat of nuclear escalation. The United States stations large numbers of forces in Europe for this purpose. The NATO Allies have not been very responsive to U.S. pressure because of the increased cost to them of conventional defense, and for strategic reasons. The Europeans argue that their patterns of defense spending, which was initially constrained by economic weakness, are now set and it is politically impossible for governments to raise them, absent a significant change in public perception of the Soviet threat. The Europeans have also questioned the strategic desirability of a conventional force equally matched to the Warsaw Pact, which may tend to de-link the U.S. strategic deterrent. Current political developments in Eastern Europe and the Soviet Union, and conventional force reduction agreements, may rapidly alter these basic perceptions. But for the present at least, the Allies appear to value the presence of the U.S. force in Europe more in terms of a guarantee of U.S. strategic linkage than for its war-fighting potential.

In theory, NATO headquarters should serve as the locus of cooperation to ensure that the forces of member countries are appropriately equipped, including standardization and interoperability of weapons systems, to perform assigned defensive tasks. NATO has developed an extensive coordinative mechanism for this purpose, headed by the Conference of National Armaments Directors (CNAD). However, NATO Headquarters has only the power to make recommendations to member governments and, in practice, has been only marginally successful in obtaining compliance. The chief reason is that the Allies have been reluctant to have an overly effective standardization program, which they fear would be based on generally cheaper and more effective U.S. weapons systems.

The Europeans have therefore preferred first to hold weapons coordination and standardization discussions among themselves, before facing the United States at the CNAD. These consultations take place within the Eurogroup, which is formally associated with NATO, and perhaps now more importantly in the Independent European Program Group (IEPG) (discussed below) which is independent of NATO.

The Europeans have denied a U.S. request to monitor meetings of the IEPG, noting that Europeans are not privy to DoD procurement deliberations. (Figure 3-3 shows the membership of the principal organizations involved in international defense collaboration.)

Proliferation of nonstandardized weapons has been decried by a succession of both U.S. and European NATO commanders, and according to some war-game scenarios, the factor of weapons standardization could make the difference between victory and defeat for NATO. However, these admonitions have not been sufficiently convincing to change current NATO practice.

Asymmetries in U.S. and European Perspectives

It is remarkable, in view of the global changes that have occurred since the end of World War II and onset of the Cold War, how little the perceptions of national interest have altered on both sides of the Atlantic. Concern about the long-term health of the U.S. economy has risen in the past decade, and more recently there has been a greatly reduced perception of the Soviet threat, but U.S. governmental expenditure, organization, and policy still largely reflect Cold War perspectives. While Americans are generally taxed at lower rates than their European counterparts, the great preponderance of discretionary Federal spending is devoted to defense. The Europeans pay less, in total and per capita, for defense and more for social welfare and the civilian economy. U.S. Federal R&D spending is centered in the military sector, European governmental R&D is civilian oriented.

The United States views NATO cohesion as the linchpin of its relations towards Europe, while the Europeans seem more apt to subordinate defense concerns to matters of economic stability and growth. The United States has an extensive apparatus for the licensing and control of militarily sensitive technology and is relatively light on governmental export promotion mechanisms, while the reverse is true in Europe. The United States has a tendency to see the Third World as a political arena for competing ideologies, the Europeans see it as a source of raw materials and an export market. These asymmetries are evident in the overall statistics: with a combined population and GNP that now exceeds that of the United States, Europe's defense spending is less than 50 percent, its procurement budget is 40

Defense Collaboration in NATO Europe

Since its inception in the mid-1960s, NATO armaments cooperation focused largely on the activities of the Conference of National Armaments Directors (CNAD), a senior body reporting to the North Atlantic Council, NATO's top political organization (see app. A). Until the mid-1980s, international collaboration in defense technology and NATO armaments cooperation were essentially congruent.

About 200 groups, subgroups, ad-hoc groups, information exchange groups, cadre groups, and working parties are organized under CNAD, with each addressing some aspect of collaboration in defense equipment. Each group is supported by one or more U.S. delegates. The work of CNAD groups ranges from attempts to harmonize national acquisition policies, to prefeasibility (or concept formulation) studies on new weapons, to applications of advanced technologies to future military needs.

The CNAD is criticized for being too complex. Because CNAD bodies face such complicated issues, however, it is not surprising that such a structure has resulted. But CNAD's complexity discourages DoD officials from pursuing cooperative activities in NATO. They prefer, instead, to use smaller and more manageable fora. However, unlike other NATO bodies, CNAD decisions do not require unanimity. If they agree on a course of action, any two or more nations can proceed with NATO's blessing. The fact that no single nation can veto a cooperative program is an often overlooked strength of the CNAD. Once an agreement to cooperate is reached in principle, participating nations negotiate agreements, sign contracts, and get programs underway — all outside NATO. Government-to-government collaborative programs funded under the Nunn amendment have also developed this way. As noted in app. B, the first of these proposals was presented at a special CNAD meeting in 1986.

Other mechanisms are used to promote transatlantic collaborative programs as well, including the so-called Four-Power meetings between the United States, the United Kingdom, West Germany, and France. The National Armament Directors from these four nations meet at least twice yearly (as do their deputies) to discuss a range of topics, often in preparation for introduction into NATO. The military departments also have four-power and bilateral meetings at the level of the Service National Representative, generally the top-level uniformed R&D official from each nation. Firm agreements on collaborative programs can result from these meetings, which often serve to coordinate positions for upcoming NATO meetings.

percent, and its defense R&D expenditure is less than **20** percent of that of the United States

Despite markedly different transatlantic perceptions of global interest, NATO has been until now a singularly stable and successful enterprise. Since its founding, it has suffered only one major setback, the withdrawal of France from NATO's integrated military structure in 1967. The Alliance nations have generally prospered, although some more than others. Open ruptures in NATO have been skillfully avoided, perhaps primarily because the emphasis on deterrence rather than war-fighting capacity allowed great flexibility in deciding acceptable levels of contributions by the member states to mutual defense. Yet the underlying tensions among the Alliance partners remains, and economic, political, and technological developments over the past years and months auger some realignment of U.S. defense relationships with Europe. The recent wave of democratic movements in Eastern Europe appears likely to accelerate the process.

The Forces for Change

Western Europe Achieves Economic Parity With the United States

During the past two decades most traces of former European economic and industrial dependence on the United States have disappeared. The balance of trade now favors the Europeans, and other economic indicators such as per capita incomes, levels of European investment in the United States, numbers of patents issued, etc., all point to the fact that the era of U.S. supremacy has passed. The forthcoming economic integration of Europe in 1992 under the Single European Act promises to expand further European economic prowess vis-à-vis the United States.

These developments have exacerbated the issue of "burdensharing," i.e., the appropriate level of U.S. support for NATO relative to European contributions. In the United States there is considerable and growing sentiment for a reduction of U.S. forces stationed in Europe, particularly if the Europeans do not raise the level of their defense expenditures. On

Figure 3-3-Organizations of Allied Defense Collaboration

	North Atlantic Treaty Organization	Conference of National Armaments Directors		European Economic Community	Western European Union	Independent European Programme Group
	NATO	CNAD	Euro Group	EEC	WEU	IEPG
Nation						
Belgium	√	√	√	√	√	√
Denmark	√	√	√	√	√	√
France	√			√	√	√
West Germany	√	√	√	√	√	√
Greece	√	√	√	√		√
Iceland	√					
Italy	√	√	√	√	√	√
Luxembourg	√	√	√	√		√
Netherlands	√	√	√	√	√	√
Norway	√	√	√			√
Portugal	√	√	√	√		√
Spare	√		√	√		√
Turkey	√	√	√	√		√
U.K.	√	√	√	√	√	√
U.S.	√	√				
Canada	√	√				
Functions	<ul style="list-style-type: none"> •Western Europe's link to U.S. •Coordinates Allied military forces 	<ul style="list-style-type: none"> •Part of NATO •Structure for military R&D and production 	<ul style="list-style-type: none"> •Harmonize operational concepts, weapons production & logistics 	<ul style="list-style-type: none"> •Common economic market •NO explicit defense role •Defense role through dual-use and R&D programs 	<ul style="list-style-type: none"> •Inner group of European nations •Focus on cooperation in defense production •Works within NATO 	<ul style="list-style-type: none"> •Central arms organization for European nations •Negotiates collectively with U.S. on defense Industrial activities •Exploits European technological resources •Eliminates cross-national barriers •Sponsors EUCLID defense R&D program

SOURCE: Office of Technology Assessment, 1990.

Defense Collaboration in Non-NATO Europe

Cooperation with non-NATO European countries is concentrated on Sweden and Switzerland. Coproduction agreements with Sweden permitted the Swedes to manufacture U.S.-designed equipment after WWII. Subsequently, the United States has purchased a few Swedish-designed and built weapons. Recently under the Foreign Weapons Evaluation program, Swedish equipment has fared well, although only nominal procurements have taken place to date. U.S./Swiss cooperation remains at a low level, but the recent Swiss decision to purchase F/A-18 fighters may generate increased cooperation. The Austrians have shown interest in working with the United States, and the U.S. Army has purchased some Austrian wheeled vehicles, and has included Austrian firms in competitions for some Army developments. More recently, the Finns have been working with DoD and the State Department to develop a mechanism for cooperation with the United States.

the European side there is concern about the **willingness** and ability of the United States to maintain its current level of support for NATO. As one European observer put it: "How long can we expect 260 million Americans to defend 320 million Europeans from 280 million Soviets?"

The burdensharing issue and the economic tensions it expresses have a depressing effect on the prospects for transatlantic weapons collaboration, as governments and private industry become wary of making heavy investments in joint projects that may be abruptly canceled by limitations on funding. The past year has witnessed a significant number of cancellations or national withdrawals on economic grounds from cooperative NATO projects involving the United States.⁸

Perceived Decline of the Soviet Threat

With the accession of Soviet President Gorbachev and the Soviet withdrawal from Afghanistan, Western perceptions of the Warsaw Pact threat to NATO have undergone rapid evolution. The election of democratic governments in Poland, Hungary, Czech-

oslovakia, East Germany, Bulgaria, and the economic and political turmoil in the Soviet Union itself have contributed to the assessment that the Soviet threat is eroding. Gorbachev's announcement of cuts in the Soviet defense budget, unilateral force reductions, and apparently more flexible positions regarding nuclear, conventional, and chemical weapons negotiations have added further credibility to the notion of a more peaceful Soviet orientation. The U.S./Soviet summit scheduled for 1990 appears likely to result in agreement for the reduction of substantial mutual reduction of forces in Europe.

While Gorbachev's initiatives have been warmly greeted on both sides of the Atlantic, there is the possibility of a substantial split of U.S. and European views concerning their ultimate significance. At this writing the Europeans appear somewhat more ready than the United States to accept Soviet reforms as irreversible and proceed with economic assistance to Eastern Europe and increased trade with the Soviets. The United States is not prepared to overlook continued Soviet military aid to Nicaragua, Afghanistan, and other areas of regional conflict. A serious rift in the Alliance could develop if, for example, there is a failure in arms control negotiations or in the event of a Soviet-backed military crack-down in Eastern Europe or the Baltic states.

From the European viewpoint, balanced U. S./Soviet arms control agreements and force reductions are highly desirable politically, but may entail some undesirable economic consequences. Apart from the reduction of direct U.S. payments for the support of its forces in Europe (West Germany alone receives approximately \$6 billion annually for this purpose) the Europeans worry about the effect on their domestic markets of U.S. defense production overcapacity. There also may be some concern about U.S. or Soviet "free sales" in Third World markets of weapons withdrawn from Europe under arms control agreements.

Perestroika and the events in Eastern Europe in late 1989 appear to have sharply accelerated declines in NATO defense spending. Managing coordinated and equitable reductions may prove a difficult and

⁷Jean-Pierre Bechter, Secretary of the Defense Committee of the French Parliament. Quoted in Cook and Gilmore, *Toward a European Pillar* (Washington, DC: Center for Strategic and International Studies, November 1988), p. 5.

⁸These include U.S. and British withdrawal from the modular stand-off weapon (MSOW), West German withdrawal from the advanced short-range air-to-air missile (ASRAAM), West German withdrawal from the NATO Multifunction Information Distribution System, and British, French, and Italian withdrawal from the NATO Frigate Replacement for the 1990s (NFR-90). "Tight Budgets, Design Conflicts Undercut NATO Weapons Projects," *Aviation Week and Space Technology*, Sept. 25, 1989, vol. 11, No. 39, pp. 18-19.

contentious issue within the Alliance. In December, 1989, the United States announced a 2 percent reduction in defense spending, while at the same time West Germany indicated plans for a 20 percent reduction in the Bundeswehr.

High Technology and Global Industrialization

The past several decades have witnessed a steep rise in international trade and a world-wide revolution in manufacturing processes. The computer and associated electronics have become major factors in practically all aspects of production, with a versatility that blurs the distinction between civilian and military applications. Moreover, these technologies have spread from the United States to Europe, Japan, and the newly industrialized countries in Asia. Most of the dynamism in computers and electronics has been due to vigorous growth in the civilian market. Thus, in contrast to the immediate post-war era, the military sector has now lost much of its dominance as the focus of high-tech innovation, and in many areas is becoming a net importer of civilian R&D. At the same time, manufacturing is losing some of its national character, with research and development for a given product taking place in one set of countries, manufacturing of components in others, and final assembly and marketing in still others. These factors are forcing a change in U.S. and European thinking about weapons production.

The question of how to maintain the requisite degree of national defense sovereignty in the face of these trends is acutely felt in the United States and Europe, but the reactions to these developments have been different. In the United States, governmental efforts remain centered on military programs to keep the United States abreast of leading edge dual-use technologies. There are also a wide variety of proposals to strengthen the U.S. defense technology base through improved DoD acquisition and R&D management, but significantly there is no consensus on how to stop or even slow the erosion of the civilian R&D base. Europe, on the other hand, has taken up this challenge in the mid-1980s by spurring intra-European civilian R&D collaboration

through such programs as BRITE, EUREKA, ESPRIT and RACE,⁹ which to some extent mirror DoD's programs. There is also a move toward improved intra-European weapons production collaboration through the IEPG, and a reorganization of European defense industries.¹⁰

CURRENT EUROPEAN PERSPECTIVES ON THE DEFENSE MARKET

Overcapacity and Transatlantic Competition

Real defense spending in NATO Europe has declined for the past 5 years and, without a sharp reversal in current Soviet behavior, the outlook for U.S. and European defense procurement spending remains bleak. European weapons suppliers and ministries of defense have felt the pinch of constrained budgets and are grappling with the economic and defense implications of increasing weapons production overcapacity. Compounding the problem is the question of export sales to third countries. European weapons manufacturers are much more dependent than their U.S. counterparts on exports (64 percent v. 24 percent of total production) and had until the past several years enjoyed a healthy \$20 billion per year surplus in third-country weapons sales. However, rampant Third World debt, the ending of the Iran-Iraq war, and declining OPEC surpluses have served to constrain this market as well.

European governments and industry perceive that U.S. producers will be similarly affected by the market decline, and their anxiety has increased about the intentions of U.S. industry to penetrate the European domestic market and compete more vigorously in the Third World. Europe has long felt that U.S. producers wield formidable competitive advantages in terms of scale: the total European procurement market amounts to only 40 percent of the U.S. domestic market, and the United States enjoys a five-to-one advantage in direct defense R&D spending.

⁹Basic Research into Industry Technology for Europe (BRITE) was initiated in 1985 to foster cooperation in a broad range of precompetitive advanced technologies with good industrial potential. European Research Coordinating Agency (EUREKA) covers the same ground as BRITE, but was launched by France in 1985 specifically to counter the U.S. invitation for European cooperation on SDI research. European Strategic Program for Research in Information Technology (ESPRIT) started in 1985 and is concerned solely with precompetitive information technologies. Research and Development in Advanced Communications for Europe (RACE) started in 1986 to lay the foundation for a Europe-wide fiber optic communications system.

¹⁰The General Accounting Office is presently studying this matter for the House Armed Services Committee. See U. S. Congress, General Accounting Office, "EC 92 and the Defense Trade and Cooperation" (in process).

Europe is also worried about the indirect threat to their defense markets posed by Japan. The Japanese are well positioned to buy into or acquire European civilian electronics firms and use these as a base to replace traditional European-owned and -operated defense suppliers.

In this sharply competitive environment, the Europeans place a very high priority on retaining access to the U.S. defense market. Despite some recent successes, such as the \$4 billion sale by France and Belgium of the RITA (Mobil Subscriber Equipment) battlefield communications system to the U.S. Army, the NATO Allies believe that the time for large government-to-government sales has passed. Thus, the approach now favored is transatlantic industrial teaming, which permits European firms to enter the U.S. market on a subcontractor basis, and the direct acquisition of U.S. defense suppliers. These private sector activities have been strongly encouraged by the Reagan and Bush administrations' free trade policies, which Congress has been reluctant to challenge.

DoD lacks systematic and timely information on foreign subcontractor sales as well as on foreign ownership of U.S.-based contractors and subcontractors, hence the full extent of European penetration of the U.S. defense industrial base is uncertain. However, there appears to be a dramatic increase in foreign takeovers of U.S. defense suppliers in the past decade. According to one study, 11 defense firms were acquired by foreign concerns in 1983, while in just the first half of 1988 alone there were 37 such acquisitions.¹¹ The 1988 Exon-Florio Amendment gave the president the power to block such takeovers on national security grounds. In the first test of the amendment, the president declined in February 1989 to exercise this authority to block acquisition of the last major U.S. supplier of silicon wafers by a West German firm. The amendment has been used recently to attempt to force the Chinese to sell back to a U.S. company an electronics firm they bought in mid-1989.

The Quest for Integration

TThe European response to the U.S. and Japanese challenges in the civilian and defense spheres has been an accelerated trend toward economic and industrial integration to protect the domestic market.

The efforts of European governments have focused on the creation of supra-national alliances in the civilian sector under the Single European Act, and in the defense sector through the Independent European Programme Group. While the economic and market impact of these developments will not be obvious in the immediate future, the European defense industry is already undergoing substantial consolidation through mergers, acquisitions and other forms of alliance.

European Community 1992

Under the Single European Act which is scheduled to come into force in 1992, the nations of Western Europe are pledged to abolish all internal duties and tariffs, harmonize national health and safety standards, and otherwise eliminate barriers to the free movement of goods, services, and persons within the European Community (EC). The resulting free market of 320 million Europeans could become the largest single trading bloc in the world.

The implications of EC 1992 for the defense market are unclear. While the Treaty of Rome specifically excludes defense trade from the purview of the European Economic Commission, Article 30 of the Treaty gives the Commission general responsibility to "maintain the technological and industrial conditions necessary for . . . security." This basic ambiguity is being widely debated in Europe. The French Government, for example, which looks toward a greater political voice for the EC, argues for a broad interpretation of Article 30, while the U.K. is opposed because it wants the EC focused entirely on economic matters.

Another point of contention is Article 223 of the Treaty of Rome, which permits member nations to list those items of defense procurement to be excluded from EC trading rules on grounds of national interest. Here the argument is whether it is legitimate to exclude such items as food and medical supplies for the military that are indistinguishable from civilian commodities.

The impact of EC 1992 on international defense trade is yet another area of uncertainty. U.S. defense trade with Europe to the present has proceeded on the basis of zero tariffs in both directions.¹² However, in a 1988 proposal, the EC had put forward the definition of such trade to include only complete

¹¹Cited by Thomas Olmstead, "Selling Off America," *Foreign Policy*, September 1989, p. 129.

¹²Not all European countries have imported all U.S. defense equipment duty free.

Defense Collaboration in Israel and the Middle East

The tempo of defense cooperation between the United States and Israel is quite fast. The two countries have signed a bilateral trade MoU (Memorandum of Understanding), and U.S./Israel government-to-government cooperation in defense technology has expanded in the past 4 to 5 years. More than 30 Data Exchange Agreements are in effect between the nations, covering areas of military tactics, technology and weapons. Both coproduction and codevelopment programs are underway. The United States has acquired and deployed several Israeli-designed systems.

The United States and Israel also cooperate in industrial programs, partly as a result of U.S. guarantees for Israel's security. Israel has historically been a major benefactor from the U.S. Security Assistance Program and has received the largest share of Military Assistance Programs and Foreign Military Sales credits. Nearly all Israeli security assistance funds have flowed back into U.S. companies, which in turn, have produced sophisticated weapons and systems for the Israeli Defense Force.

With the bilateral trade MoU has come a greater attempt by Israeli industry to sell directly to DoD, with uneven results. Israeli companies have demonstrated growing knowledge of the U.S. market and DoD's procurement system. In selected cases Israeli battle-proven weapons and expertise in advanced technologies have been acquired by the United States.

Since the Camp David Accords were signed in 1978, the United States has assisted Egypt in developing its armed forces and defense industrial base. A few data exchange agreements are in place and a number of co-production efforts have begun.

The United States has sold major defense systems to Saudi Arabia under the Foreign Military Sales program, including AWACS and F-16s. These sales and subsequent support have been profitable for U.S. defense companies. U.S. industry lost significant sales in 1987 when the Saudis signed a major defense equipment deal with the United Kingdom. The U.K. program, named Al Yamamah, was viewed by some observers as a reaction to the refusal by Congress to approve the sale of additional F-15s to the Saudis.

systems such as tanks, airplanes, etc. The United States vigorously protested this, since U.S. defense exports to Europe consist now almost entirely of subsystems, which would be subject to tariffs under the proposed EC definition.

Another EC 1992 issue that may affect international defense trade is the treatment of foreign-owned subsidiaries. The EC asserts that these subsidiaries will be treated as European-owned firms only if high value-added activities (research, design, engineering, etc.) are performed in Europe. The intention here is to block the establishment of so-called "screwdriver" plants in which imported high-tech components are merely assembled.

Over and above these specific issues, it is certain that EC 1992 will have a major impact on how weapons are produced and traded in Europe if simply because nearly all European defense producers also have large civilian sector operations.

The Independent European Programme Group (IEPG)

The IEPG was established in 1976 as an off-shoot of the NATO-affiliated Eurogroup of European

defense industries for the purpose of bringing France into its deliberations. The IEPG was of minor significance until the issuance of the Vredeling Report in 1986, which called for much greater European collaboration in weapons production. This led in the subsequent endorsement by European defense ministers of an Action Plan listing as the major goals:

- establishment of an open European market for defense procurements, including sharing of national procurement plans and defining areas for European-wide competition;
- "Juste Retour," ensuring that intra-European national defense imports and exports roughly match through a system of recording cross-border contracts;
- technology transfer policies that promote the dissemination of government-supported defense R&D to all IEPG member nations;
- assistance to Less Developed Defense Industry (LDDI) members (i.e., Greece, Portugal, and Turkey); and
- creation of a common fund for defense R&D to be allocated by the IEPG.

To what extent these goals will be realized is questionable. First, unlike the EC, the IEPG has no legal status. The Action Plan represents little more than a loose set of intentions, albeit with official sanction, and there is by no means a full consensus on its implementation. German industry, for example, expresses strong reservations about the “Juste Retour” and LDDI goals, which may result in a substantial displacement of employment from Germany to other countries. Second, and perhaps more important, is the question of how the IEPG will affect defense relations with the United States. There is great ambiguity here, and what is said about the intentions of the IEPG depends on who the audience is. In Europe it is widely understood that the impetus behind the Vredeling Report and the Action Plan was the fear of domination of the European weapons market by U.S. producers. However, in explaining the IEPG for U.S. consumption, the emphasis is on how the creation of a “European Pillar” in defense production will make the Europeans stronger and better NATO allies. Increasing economic unity arising out of EC 1992 may create need for a central procurement agency, which is being studied in the IEPG.

One of the difficulties facing the IEPG is how to differentiate its common fund for defense R&D, known as EUCLID,¹³ from other European cooperative civilian research programs covering dual-use technologies. EUCLID has been off to a slow start compared to other cooperative efforts. Estimated allocations to EUCLID amount to only \$140 million, compared to \$5.4 billion for European Research Coordinating Agency (EUREKA) programs. One European source indicated to OTA that EUCLID was created primarily to tap Bundeswehr R&D funds, since West German law prohibits contributions of these funds for civilian projects.

European Industrial Integration

The European defense industry is rapidly positioning itself to face tougher competition in leaner times. On the national level, there is a continuing concentration of defense producers through mergers and acquisitions. In the key aerospace and defense

electronics sectors, the trend is for each major producer nation to remain with one or two large firms: British Aerospace/Westland/GEC in the United Kingdom; Daimler-Benz/MBB/Siemens in Germany, Aerospatiale/Dassault/Thomson CSF in France. On a smaller scale, intra-European strategic alliances of these major firms are being created through such mechanisms as stock swaps and joint acquisitions as, for example, the recent successful GEC/Siemens acquisition of Plessey.

Current Policies of Key European Governments

The only nations of Europe that possess the research and industrial capacity to produce competitively a wide variety of major weapons systems are the United Kingdom, France, and West Germany. Other European nations may possess a world-class capability, but are restricted in scope, such as Italy for naval guns and helicopters and the Netherlands for optics and electronics.

The United Kingdom

The United Kingdom has consistently outpaced the other European states in defense spending and support for defense R&D. Stung by some costly failures, such as the Nimrod airborne early warning system and under tight national defense budgets, the United Kingdom has in recent years sought to raise efficiency by privatizing government-owned defense industries and research laboratories. While the United Kingdom traditionally has been the strongest European proponent of transatlantic defense cooperation (e.g., Trident, Harrier) a perceptible shift toward a more European orientation has taken place during the past 5 years. The 1985-86 furor over the Sikorsky bid for Westland Helicopters was dramatic evidence of the sensitivities underlying the issue of U.S. defense influence. United Kingdom defense exports have been a bright spot in an otherwise lack-lustre industrial picture, and may have been behind the United Kingdom's strong support to reactivate the IEPG. Another motivation may have been to deflect French attempts to upgrade the influence of the EC in defense and political affairs.

¹³European Community Long-term Initiative for Defense. At an IEPG meeting in Lisbon in early 1988, priority research fields for the EUCLID program were listed as radar technology, microelectronics and semiconductors, composite materials, avionics, artificial intelligence, opto-electronics, simulators, underwater listening devices, stealth and space surveillance. See Michael Guerin, “EUCLID Defense Cooperation Seen Essential,” *Defense & Armament Heracles*, Paris, September 1989, pp. 041.

France

French defense policy has long been oriented toward autarchy in domestic procurements and a strong export effort. France has also been most sensitive to U.S. defense influence in Europe, and tends to suspect ulterior commercial motivations for U.S. defense initiatives. The French devised the EUREKA civilian research program in direct response to U.S. efforts to obtain European cooperation for the Emerging Technologies and SDI programs, on the grounds that a U.S. motivation was to stunt the development of European R&D. Increased French activism in European defense affairs during this decade may be partially influenced by the objective of stemming West German neutralism, and perhaps more importantly by commercial interest.

The previous go-it-alone policy, typified by the Rafale fighter designed specifically for Third World export, has not been a success, and France is therefore positioning itself to obtain a larger slice of the NATO defense market. The French strategy in this regard may be to use the levers of the IEPG and EC 1992 to displace U.S. defense sales to the smaller NATO countries, the last significant European market in which U.S. defense technology predominates. For success in this strategy, the French will have to team with the United Kingdom or West Germany, and may already be worried about a growing U.K./German defense production nexus.

West Germany

Although West German industry has achieved a dominant industrial position in Europe, governmental support for defense R&D has been relatively small. For historical reasons, the Germans have been reluctant to develop a large independent armaments industry and engage in direct defense exports. They therefore prefer a teaming approach (e.g., the Tornado fighter) which provides the benefits of high-tech domestic employment and a share of export sales, without the political disadvantage of being a

Defense Collaboration With Canada

Canada is treated differently by DoD from the rest of the NATO Allies. The United States and Canada have shared a long history of defense and economic cooperation codified in more than 200 agreements. As part of the North American industrial base, Canadian companies can compete for U.S. programs that fall under U.S. Mobilization Base restrictions. The 1987 U.S./Canadian free-trade agreement resulted in the creation of the North American Defense Industrial Base Organization with abroad charter to promote and administer joint peacetime Industrial Preparedness Programs. The existence since the 1940s of a bilateral defense trade agreement has also emphasized Canada's special position in defense cooperation with the United States.

In some mission areas, e.g., North America air defense, the two nations have established close government-to-government ties. U.S. companies find it easy to cooperate with their Canadian counterparts. However, Canada's outlays for defense R&D and its overall defense industrial base are small compared to those of the United States, the major NATO countries, and Japan. Accordingly, Canadian/U.S. defense cooperation is small in relation to overall U.S./Allied defense collaboration.

prime contractor. This low-profile attitude may now be changing. With the merger of Daimler/Benz with MBB, the Germans will have a prime defense contractor of formidable proportions, although it still will be heavily weighted towards the civil sector. German international industrial strategy appears founded on teaming German firms with a solid civilian R&D base with foreign firms specializing in defense R&D. Thus, the acquisition by commercially oriented Siemens/GEC of the defense-based Plessey firm seems to be a logical result of this strategy.

Chapter 4

Emergence of Transpacific Collaboration: The Case of Japan

CONTENTS

	<i>Page</i>
SUMMARY	61
COOPERATION WITH JAPAN	61
THE U.S. POLICY FRAMEWORK	62
DEFENSE PROGRAMS AND CIVILIAN SECTORS	63
IMPLICATIONS OF MARKET STRUCTURE ON TECHNOLOGY TRANSFERS, BILATERAL COMPETITION	64
ATTITUDES TOWARD DOMESTIC PRODUCTION	66
INDIGENOUS PRODUCTION v. COLLABORATION	66
U.S. v. JAPANESE APPROACHES TO SECURITY	68
FUTURE ISSUES—JAPAN	70

Figure

<i>Figure</i>	<i>Page</i>
4-1. Coproduction of U.S. Planes, Helicopters, and Engines in Japan, 1954-66	65

Emergence of Transpacific Collaboration: The Case of Japan

SUMMARY

Cooperative defense programs have been fundamental in U.S.-Japan security relations since the Korean war. Defense collaboration has been pursued for both economic and strategic military reasons, but until recently the United States has favored the latter while Japan has placed at least equal emphasis on the economic aspects of such programs. The United States generally has been willing to overlook the economic consequences of these policies to satisfy its higher priorities of preserving the regional military balance in Asia and of assuring that Japan remains a close ally.

The shift from Japan as buyer to Japan as developer of independent weapons systems has forced the United States to reconsider its traditional postwar policies, especially because advanced technologies have potential applications in both military and civilian sectors. Furthermore, Japanese firms have pursued a different agenda throughout the postwar period, emphasizing the economic gains of military production at least as much as their military benefits. With Japanese industrial capabilities nearing or surpassing those of the United States in many fields, the potential economic challenges to the United States cannot be dismissed.

COOPERATION WITH JAPAN

The Mutual Cooperation and Security Treaty of 1960 established the fundamental basis for the overall U.S.-Japan bilateral security relationship while the Mutual Defense Assistance Agreement (MDAA) of 1954 established the legal basis for providing equipment and technology to Japan. As Japan's role as a provider of technology grows, the agreement is also important to U.S. policymakers in developing arguments for technology 'flow-backs' to the United States to reciprocate, in a sense, for years of technological imports by Japan.

Collaboration between the United States and Japan in the production of advanced weapons systems, and transfer of military-related technology from the United States to Japan, emerged in the late 1970s as a key element of the overall growth of

U.S.-Japan defense cooperation and Japan's effort to build up its military capabilities. By the end of the 1980s, however, collaboration had become *controversial* between the two nations amidst growing economic disputes between Tokyo and Washington. The merits of collaboration were debated by government officials, influential organizations, and individuals on both sides of the Pacific.¹ The belief that collaboration is mutually beneficial was under criticism by the end of the decade. This, coupled with a changing international security environment, has made collaboration a more uncertain proposition in Japan-U.S. relations of the 1990s.

Collaboration in defense production goes back to the beginnings of the defense relationship in the 1950s. The MDAA provided the basis for sales of American weapons to Japan and the coproduction of weapons systems developed in the United States. The agreement provided for broad exchanges of defense "equipment, materials, services, or other assistance, and it contained a reference by Japanese Government officials to the desirability of U.S. assistance to Japan's defense industries.

Coproduction emerged in the 1960s as the key element of defense production collaboration, accelerated by the discontinuation of American military assistance to Japan in the mid-1960s. Cooperative programs expanded after 1975, and remained paramount until the latter part of the 1980s. Nearly all arrangements were made between Japanese and U.S. firms with government approval. Under these transactions, the two governments signed a Memorandum of Understanding (MoU), to allow Japanese firms to produce U.S. equipment under a licensing agreement. The U.S. firm typically provides data on manufacturing procedures, machinery and tools, components, management assistance, and help in quality control.

The U.S. and Japanese Governments agreed to two other forms of collaboration in the 1980s. The first dealt with the transfer of Japanese military technology to the United States and was formalized in an exchange of notes in November 1983. The notes established a Joint Military Technology Com-

¹Concerns over the FSX were widely publicized in the United States. For Japan's part, these problems manifested themselves in Strategic Defense Initiative (SDI) negotiations, where private businesses in Japan were concerned that they would not be allowed by the terms of participation to utilize advances for commercial products.

mission (JMTC) to review requests by the United States and the responses of the Japanese Government. The Japanese Government promised in the notes to facilitate the flow of military technologies to the United States and to encourage the transfer of related technologies (dual-use technologies such as materials, operations systems, and components) developed for nonmilitary purposes but applicable to advanced weapons systems.

A second new form of collaboration is codevelopment. The prototype of a U.S.-Japanese codevelopment agreement is the FSX fighter. General Dynamics Corp., the U.S. participant, will provide an advanced airframe and wing sets for testing and aft fuselages. Japanese firms will contribute a phased-array radar, and reportedly new, lightweight materials for aircraft wings. Under a MoU signed in November 1988, U.S. firms in the project will have access to this Japanese technology. U.S. firms will receive 35 to 45 percent of the development costs paid by the Japanese Government and about 40 percent of the \$5 billion realized through sales to the Japanese Government. Unlike codevelopment projects between the United States and NATO countries, the United States does not intend to acquire the FSX for the U.S. Air Force.² In U.S.-European codevelopment deals, a U.S. commitment to purchase is often an integral offset of guaranteed profits to the American participants.

THE U.S. POLICY FRAMEWORK

Although economic considerations have not been entirely absent from U.S. policy, military and security considerations have been the decisive elements in U.S. policy toward Japanese arms production in the post-World War II period. American strategy has separated the economic, political, and military components from one another. Issues have been viewed in isolation or in the context of overall U.S. relations with East Asian nations, specifically regarding the security ties deemed necessary to counterbalance communist influence and Soviet military presence in the region. From a foreign policy perspective, both the United States

and Japan frequently warn of the danger of trade tensions spilling over into the defense arena.³

As early as the Korean war, U.S. defense planners saw the utility of Japan serving as a forward line of defense in Asia, providing both a base for U.S. forces in the region and a source of logistical support. Japanese business and government saw opportunities for economic recovery in the same crisis. Japan resuscitated its domestic aircraft industry in 1952 by manufacturing spare parts for U.S. military aircraft based in Japan, a full 2 years before the establishment of either the Self-Defense Forces or the Japan Defense Agency (JDA). Total aircraft production in Japan rose from 29 million yen in 1952 to 2,451 million yen the following year.⁴ During the 1952-54 period, demand by the U.S. armed forces in Japan constituted between 60 and 80 percent of total aircraft production. The Japan Defense Agency gradually supplanted the U.S. presence, and by 1958, over 80 percent of total aircraft production was directed to JDA needs.⁵

Because of the relative weakness of the Japanese economy in general and the aerospace industry in particular, these growth trends were not viewed with any sense of alarm. Instead, they justified U.S. policies to help stimulate economic growth in the war-torn Japanese economy, to reduce the threat of Japan becoming a burden for the United States, and to strengthen the security alliance in the Pacific. These strategic factors also predominated in the years that followed.

The U.S. strategic posture provided the policy framework for more generous coproduction agreements from 1978 through 1985. F-15 fighters, P-3C antisubmarine aircraft, and Patriot **surface-to-air missiles** were either specified in Reagan administration proposals for Japan's self-defense or fell within the U.S. emphasis on Japan's air defense and sea control capabilities. They were also central to the U.S. goal of persuading Japan to **modernize existing forces** rapidly. Key Japanese **sea** and air defense **systems** (such as the F-104 fighter, P-2J antisubmarine aircraft, and the Nike-J **surface-to-air missile**) were either **aging or obsolete** by 1980. Coproduction

²Industry observers have suggested, however, that General Dynamics is looking to the project in order to help develop its "Agile Falcon," an advanced version of the F-16 for deployment in Europe with multiple missions capability. Daniel Sneider, "Mitsubishi, General Dynamics 'Very Close' To Signing FSX Contract," *Defense News*, vol. 4, No. 49, Dec. 4, 1989, p. 8.

³Richard L. Armitage, "The U.S.-Japan Alliance," *Defense* 86, July/August 1986, pp. 20-22.

⁴Society of Japanese Aerospace Companies, Inc., "Aerospace Industry in Japan, 1987-88," p. 11.

⁵*Ibid.*, pp. 3-13.

offered a means of bringing modern systems into the Japanese military arsenal within a relatively short period of time.

U.S. officials also viewed coproduction as helping to achieve the objective of broadly based defense cooperation, which 1978 guidelines spelled out. Stepped-up coproduction occurred amidst progress in joint planning, an expansion of joint military exercises in scope and frequency, greater coordination of intelligence, and agreement on the U.S. deployment of F-16s to the Japanese home islands (U.S. fighter squadrons had been stationed only on Okinawa).⁶

The Pentagon also stressed the military advantages of common use by U.S. and Japanese forces of U.S.-designed weapons.⁷ Standardization of weaponry would facilitate combined operations and would make possible mutual logistical support, including the establishment of joint stockpiles of weapons and ammunition and the U.S. ability to resupply Japanese forces in a war-fighting situation.

The Pentagon, however, displayed concern about maintaining control and secrecy over sensitive technological components of weapons produced through coproduction. There was concern that such technology could fall into the hands of the Soviet Union or other unfriendly powers.⁸ The Department of Defense (DoD) rejected the JDA request to grant Japanese firms access to all software in coproducing the Patriot missile, including the guidance and target identification components.⁹ Similarly, DoD withheld data on electronic systems, radar equipment, and compounds used in the body of the F-15.¹⁰ Nevertheless, subsequent reviews of the F-15 MOU resulted in the Defense Department releasing some materials technology and other items that had previously been withheld.¹¹

Commercial considerations have played a secondary role in the decisions of U.S. Defense Department officials regarding coproduction. In contrast to that attitude, the Japanese Government has consistently shown a preference for coproduction over direct purchases of American equipment, a policy that was augmented with the end of U.S. military aid to Japan in 1968. Coproduction was an established practice by 1975. It also coincided with numerous coproduction arrangements with NATO Allies. Official U.S. policy, in fact, had designated Japan as one of several countries eligible for coproduction of U.S.-designed equipment.¹²

While DoD ignored or minimized the commercial impact of its policies, commercial considerations became paramount in the decisions of U.S. companies to enter into coproduction.¹³ License fees and the lucrative upgrade business have rivaled or surpassed the profits companies could make through off-the-shelf sales without posing any problems associated with expanding production for comparatively small orders. In addition, U.S. firms have been dissuaded from holding out for direct sales by their assessment of several factors: the Japanese Government's commitment to progressive coproduction of American weapons rather than purchase, the parallel policies of NATO governments favoring coproduction, the occasional possibility of Japanese coproduction deals with European competitors, and Japan's growing capabilities to produce similar, if less technologically sophisticated, systems without foreign participation.

DEFENSE PROGRAMS AND CIVILIAN SECTORS

In 1984 a Defense Science Board report noted Japan's pattern of indigenous defense production

⁶U.S. Congress, Joint Economic Committee, Subcommittee on Economic Goals and Intergovernmental Policy, *Japan's Economy and Trade With the United States: Selected Papers*, 99th Cong., 1st sess., 1983, p. 209.

⁷U.S. Congress, General Accounting Office, *U.S. Military Co-production Programs Assist Japan in Developing Its Civil Aircraft Industry*, #ID-82-23 (Gaithersburg, MD: Mar. 18, 1982), p. 1.

⁸Michael W. Chinworth, "Industry and Government in Japanese Defense Procurement: The Case of the Patriot Missile System," MIT-Japan Science and Technology Program Working Paper 88-04, 1988, p. 21.

⁹*Ibid.*, pp. 24-25.

¹⁰Reinhard Drifte, "Japan's Growing Arms Industry," P. S.I.S. Occasional Papers Number 1/85, Geneva, Switzerland, Program for Strategic and International Studies of the Graduate Institute of International Studies, 1985, pp. 75-76.

¹¹U.S. Congress, General Accounting Office, *U.S. Military Co-production Programs Assist Japan in Developing Its Civil Aircraft Industry*, #ID-82-23 (Gaithersburg, MD: Mar. 18, 1982), p. 7.

¹²*Ibid.*

¹³U.S. Department of the Army, Office of Management and Budget, "Second Annual Report on the Impact of Offsets in Defense-Related Exports," December 1986, p. II-29.

and underscored the Japanese Government's role in high technology, its drive to develop self-sufficiency in defense production and the perceived link between commercial and defense projects.¹⁴ A 1985 DoD task force report identified 16 dual-use technologies, including fiber optics, X-ray lithography, and ceramic materials in which the Japanese excelled.¹⁵

More recent Japanese assessments have stressed this 'spin-on' the use of existing and new commercial technologies in the military sector and/or developing new military products and applications out of commercial technologies. This philosophy was a major element in *Japan's Choices*, a recent survey of future economic policy directions sanctioned by the Ministry of International Trade and Industry (MITI).

IMPLICATIONS OF MARKET STRUCTURE ON TECHNOLOGY TRANSFERS, BILATERAL COMPETITION

The competitive impact of U.S. collaboration in defense technology with Japan is heightened because Japan has a limited number of market participants, each of which is in a position to absorb technology from a number of mature U.S. firms.¹⁶ As illustrated in figure 4-1, major Japanese contractors typically have overlapping relationships with several U.S. defense contractors. While many of the Specific programs illustrated in the figure are dated, the patterns nevertheless demonstrate that Japanese companies are the focal points where technology from several U.S. firms converge in cooperative programs. These same Japanese firms often have prime contractor-subcontractor relationships that facilitate the transfer of technology throughout the domestic industry. By implication, any technology transferred from a single U.S. firm has the potential to benefit multiple contractors in Japan.¹⁷

The high degree of subcontracting in Japanese defense production contributes to the potential for building the Japanese defense industrial base through licensing agreements with American companies. In keeping with trends throughout Japanese industry, the percentage of subcontracted work in Japanese programs can run as high as 80 percent. This diffusion of contracting work contributes to the growth of the domestic defense industrial base in Japan. Since subcontractors are also a significant source of innovation for Japanese civilian industries, similar patterns could emerge in domestic defense industries as well, as these companies grow more experienced in defense production. Thus, proportionately larger numbers of firms in Japan have potential opportunities to develop their capabilities through licensed defense production from the United States and emerge as possible competitors to U.S. firms, especially to second-tier contractors. The competitive implications for the United States extend beyond the military sector because of the emphasis by Japanese firms on multiple applications of technologies, their highly diversified, vertically integrated structures, and the relative lack of regulatory and other obstacles that would retard application of military technology to civilian products.

In many Japanese facilities, civilian and defense production occurs side-by-side.¹⁸ Subcontract work for Boeing aircraft has been carried out in Mitsubishi Heavy Industry's (MHI) Nagoya works along with F-15 production and the now defunct MU-300, a private corporate jet that failed to make headway in either U.S. or Japanese markets. This constitutes a subsidy to those industries in Japan that work with defense--to the extent that production facilities and overhead costs financed by defense budgets are actually exploited for nonmilitary production. This possibility also appears evident in the case of MHI missile production, where missile production facili-

¹⁴U.S. Department of Defense, Office of the Under Secretary of Defense for Research and Engineering, *Report of the Defense Science Board Task Force on Industry-to-Industry International Armaments Cooperation: Phase II—Japan* (Springfield, VA: National Technical Information Service, June 1984).

¹⁵U.S. Department of Defense, Office of The Under Secretary of Defense (Acquisition), Research and Advanced Technology, "Electro-optics Millimeter/Microwave Technology in Japan," report of the DoD Technology Team, 1987. The preliminary report was issued in May 1985 and the final report was released in May 1987.

¹⁶See app. D for a discussion of the domestic defense industry in Japan.

¹⁷G.R. Hall and R.E. Johnson, "Transfers of United States Aerospace Technology to Japan," Raymond Vernon (ed.), *The Technological Factor in International Trade* (New York, NY: Bureau of Economic Research, 1970), pp. 305-363.

¹⁸Prepared testimony of Joseph E. Kelley, director, Security and International Relations Issues, National Security and international Affairs Division, General Accounting Office, before the House of Representatives Energy and Commerce Subcommittee on Commerce, Consumer Protection and Competitive, Feb. 23, 1989, p. 8.

Figure 4-1-Coproduction of U.S. Planes, Helicopters, and Engines in Japan, 1954-66

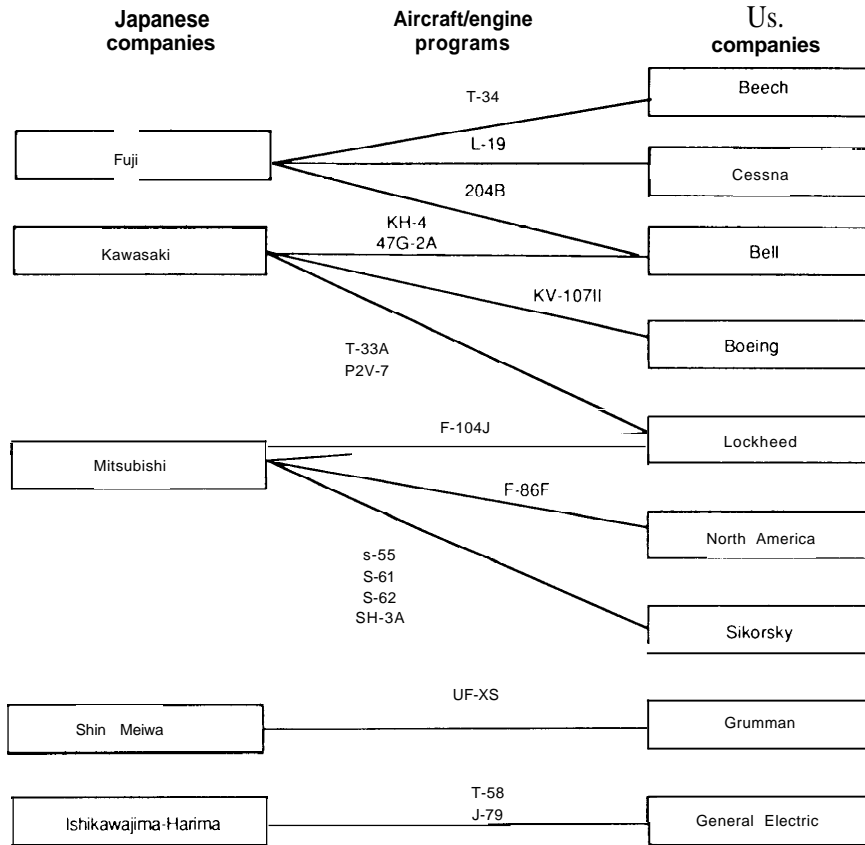

SOURCE: G.R. Hall and R.E. Johnson, "Transfers of United States Aerospace Technology to Japan," Raymond Vernon (ed.), *The Technological Factor in International Trade* (New York, NY: Bureau of Economic Research, 1970), p. 314.

ties have been separated entirely from other aerospace facilities to provide additional production capabilities.

From time to time, American defense firms also use workers and production facilities for one program that actually were financed by another.¹⁹ Japanese companies have taken this one step further, adding civilian production to the picture and multiplying the potential for diversification and entry into new markets. This could explain why Japanese industry is proceeding to expand defense production despite the apparent costs and limited markets. It also raises the question of whether Japanese companies use their defense investments more effectively than the United States. The "spin-on" theory in Japan is not limited to products; it also extends to the facilities used to produce them.

This has important implications for the United States if domestic defense budgets are reduced drastically. Effective use of production capabilities provides Japanese firms with more numerous options than those available to U.S. defense contractors. If the military component of the Japanese missile market fails to materialize, for example, MHI will be in a position to reallocate production facilities to projects in the country's growing civilian space program. Although such a shift is not beyond the abilities of American defense contractors, U.S. firms nevertheless are often so dependent on DoD contracts that they may face insolvency before they are able to anticipate and implement comparable adjustments to market conditions.²⁰

This is not a recent phenomenon for Japanese firms. It is literally a way of life. For example,

¹⁹Donald L. Pilling, *Competition in Defense Procurement* (Washington, DC: Brookings Institution, 1989), pp. 13-15.

²⁰See "Assessment of Research and Development Opportunities in Defense-Related Technologies," September 1989, p. 3.

Yamaha, a well-known manufacturer in Japan of musical instruments, shifted production from pianos to aircraft parts as conflicts heightened in World War II, only to shift back to piano manufacturing, after the surrender, with equal ease and fluidity. While other Japanese firms may have had more difficulty than Yamaha, recent indications point toward Japanese agility in shifting between different types of production.²¹ It is likely that Japanese companies will be better able to adapt to changing defense budgets while also being able to benefit from spinoffs and spin-ins from technology transfers resulting from cooperative programs. In Japan, defense budgets have grown steadily over the past two decades at stable rates, unlike their more erratic U.S. counterparts. This provides additional long-term stability in the domestic defense industry, reducing uncertainties facing Japanese managers and strategic planners. Although additional data are needed to draw firm judgments, it is reasonable to believe that sharing defense and civilian resources (plant facilities, skilled labor, etc.) is a common practice in Japanese firms, especially among larger contractors. This suggests that excess defense production capacity in Japan can be converted with relative ease to commercial production, and that “surge capacity” may belittle more than a backdoor means of expanding commercial production capabilities.

ATTITUDES TOWARD DOMESTIC PRODUCTION

Cooperative programs with Japan, as in Europe, tend to move up the collaboration ladder from licensing toward codevelopment. The more work allocated to local industries, the more experienced and skilled these firms have become. This in turn has led to higher expectations of contributing more value-added components in successor programs. Ultimately, of course, this could threaten U.S. companies through the creation of potential competitors, although Japan would have to modify its ban on the export of military technology.

In the Japanese experience, there is an import substitution pattern of replacing U.S.-licensed sys-

tems with domestic counterparts as soon as is feasible. In some instances it involves components, as in the case of avionics upgrades for F-4 Phantoms originally produced under license. In other cases, complete systems have been supplanted by domestic alternatives, including the AAM-3 (which replaces the U.S. Sidewinder air-to-air missile), the ASM-1 (in place of the U.S. Harpoon air-to-surface missile), and the Keiko-SAM (in place of the U.S. Stinger, a hand-held missile used for short-distance, point defense).

The JDA has announced costly defense programs specifically to develop successors to systems supplied by the United States, in many cases under license production arrangements. These include a medium range surface-to-air missile system (currently designated M-SAM) to replace Raytheon’s Hawk SAM and a supersonic engine development program that optimistic observers in Japan have suggested could be used for the FSX, alleviating any need to license an engine from the United States for the program.²²

INDIGENOUS PRODUCTION v. COLLABORATION

The 1954 Mutual Defense Assistance Agreement stated the Japanese Government’s goal of developing a domestic defense industry, and the government has followed this policy consistently, giving it increased priority as it began the defense buildup in the late 1970s. The government reaffirmed its intention to develop and provide business for private defense firms in a “Basic Policy for Development and Production of Defense Equipment” put out by the Defense Agency in 1970.²³

Like many European governments, Japan has chosen this course despite the higher costs and longer lead times associated with domestic production. A primary objective is to provide opportunities for Japanese companies to develop and expand production in defense, and to apply civilian technologies to weapons systems, both in the initial production stage and in followup modifications and improvements. A stronger, more diverse defense industry gives the government more flexibility and

²¹For an examination of the contrasting experience of the United States in terms of transforming peacetime industry to war production and then back again, see Merritt Roe Smith (ed.), *Military Enterprise and Technological Change* (Cambridge, MA: MIT Press, 1987).

²²“Japan to Develop First Independent Surface-to-Air Missile,” *Nikkei News Service*, Apr. 20, 1989; “Defense Agency to Develop Supersonic Engine,” *Nikkei News Service*, Aug. 11, 1989.

²³Rheinhold Drifte, “Japan’s Growing Arms Industry,” op. cit., footnote 10, pp. 10-11.

independence in setting future defense priorities. It also ensures availability of spare parts and prompt maintenance.²⁴

Political considerations are also important. The government faces a continuing problem of justifying the defense buildup in the face of anti-defense public sentiment, media that are often hostile to military programs, and opposition political parties unsympathetic to stated defense goals. A policy that supports domestic industry through defense programs helps gain the support of business and business-influenced groups for defense policy, including increased defense spending.²⁵ Nevertheless, the government continues to restrain the development of a defense industry, by imposing extensive restrictions on arms exports, which the government outlined in 1967 and expanded in 1976.

Coproduction and codevelopment with U.S. firms helps domestic industries secure technology that will improve their capabilities in diversifying potential weapons production and in related nonmilitary fields. The government's 1976 defense white paper declared foreign licensing agreements had "accomplished the acquisition of manufacturing technology. . ."²⁶ The 1988 white paper elaborated that: "In recent years, various high technologies have been increasingly integrated into military, hence it is desirable that Japan should utilize to the fullest extent the defense-related technologies owned by the U. S." It added that Japan would seek from the U.S. secret technical information in order to strengthen Japan's future research and development of military equipment.²⁷ The 1989 white paper laid out similar policy aims with regard to codevelopment with the United States.²⁸

These sources would indicate that the Japanese Government clearly has a long-term objective of producing major weapons system strictly with Japanese resources and technology. It stated this preference in the 1976 white paper and prescribed

coproduction and importation of foreign production technology to fill gaps in Japanese industry's expertise.²⁹ But the Japanese Government is not so cohesive as these sources suggest. In the FSX case, for example, industry, the JDA (including the Technical Research and Development Institute (TRDI) and the Air Staff Office), and MITI's Aircraft and Ordnance Office advocated domestic development. On the other side, MITI's Trade Bureau, JDA's budget officials, the Ministry of Finance (MOF), and the Ministry of Foreign Affairs were either cautious or opposed to domestic development without U.S. collaboration. Despite the careful groundwork laid by the proponents of indigenous development, the final decision endorsed collaboration.³⁰

As noted in appendix C, security policies are formed to a large extent by committee, with nonmilitary interests representing important views. These include, for example, those of the Ministry of Foreign Affairs, which is concerned with the impact of increasing autonomy in defense production on relations with the United States in general, and the mutual security treaty in particular. Some argue that even the economic interests represented by MITI do not necessarily translate into support for indigenous systems, noting that in 1986 the ministry revised its approach to aircraft development to emphasize international cooperation. Even former defense agency directors do not always side with those in the agency favoring autonomous production, noting again the importance of restraining autonomous development and production in the name of relations with the United States.³¹

Some analysts argue, however, that "restraining" domestic development and production does not necessarily mean reversing the trend toward increasing domestic supply of weapon systems, but simply slowing the pace a degree. They interpret MITI's well-publicized decision to encourage international cooperation as a tactical adjustment in a long-term strategy that remains directed toward

²⁴Japan Defense Agency, "Defense of Japan, 1978," p. 117.

²⁵Michael W. Chinworth, "~~~~q and Government in Japanese Defense Procurement," *op. cit.*, footnote 8, p. 10.

²⁶Japan Defense Agency, "Defense of Japan 1976," p. 126.

²⁷Japan Defense Agency, "Defense of Japan 1988," p. 181.

²⁸Foreign Press Center (Japan), "Summary of 'Defense of Japan 1987,'" p. 49.

²⁹Japan Defense Agency, "Defense of Japan 1976," pp. 125-127.

³⁰Richard J. Samuels and Benjamin C. Whipple, "Defense Production and Industrial Development: The Case of Japanese Aircraft" Chalmers Johnson et al. (eds.), *Politics and Productivity* (Cambridge, MA: Ballinger Press, 1989), pp. 293-305.

³¹Former director general Koichi Kato, for example, enunciated such views in an interview on Feb. 28, 1989 with the *Asahi Shimbun*, one of Japan's leading daily newspapers, on the FSX controversy.

developing a domestic aircraft industry. In this view, the means alone have changed, with Japanese companies being encouraged to team with foreign partners in the short-term to realize this long-term objective rather than relying solely on internal and government resources.

In addition, the annual defense white paper has continuously underscored the policy objective of self-reliance since its initial publication in 1970. The white paper must be formally approved by the cabinet and the Security Council to be released and as such represents official government policy. There can be no doubt that policy divisions have existed in the past and will continue in the future. However, the long-term trend is toward autonomy at this point and represents a continuum throughout the postwar period.

Those who do not see a Japanese effort to supplant foreign systems entirely with domestic products point to the FSX codevelopment program, and to recent Japanese decisions to acquire Aegis destroyers through the Foreign Military Sales program from the United States. Each vessel purchased will bring in over \$500 million in sales to this country. Furthermore, it is likely that Japan will also deploy U.S. AWACS in the near future. These transactions will help maintain the U.S. shine of Japan's defense market in the short-run, which varies, but is currently about \$1 billion annually in sales and license fees. These analysts believe that the Japanese white papers state policy in a very general way, allowing flexibility on the part of various actors, and therefore that less emphasis should be placed on them in identifying policy, at least if the concern is with actual government behavior.

However, these cases are more important initially for their precedent-setting value in overall security policies for the government than as potential sales to industry. Both Aegis and AWACS will represent quantum policy leaps in the context of Japan's postwar defense policy because of their highly advanced capabilities. Decisions to deploy sophisticated defense equipment can become highly politicized issues, subject to intense parliamentary debates. Consequently, deployment decisions can be defended more easily if other diplomacy and/or political agendas are addressed by doing so. In this case, the procurements can be justified in part in the

name of improved U.S. relations since they will generate significant U.S. contracts or sales that will help diminish divisive trade frictions.

For JDA, the important thing is the precedent of deploying state-of-the-art military systems that will give the Self-Defense Forces greater technological leverage. Once these foreign-supplied systems are deployed, however, both industry and government may lobby for substituting domestic upgrades for foreign components in deployed systems. This may lead to further pressures for the development of totally domestic replacements.

U.S. v. JAPANESE APPROACHES TO SECURITY

By the end of the 1980s, the escalation of economic and trade disputes had begun to affect a number of defense issues between the two countries, including cooperation in military technology. U.S. sensitivity to and fear of Japanese economic competition has subjected defense cooperation to considerable scrutiny. Critics charge that coproduction and codevelopment programs transfer to Japanese companies technology that may later be useful in producing civilian goods that compete with U.S. products, and specifically that collaboration in military aircraft will assist Japan in building up its civil aviation industry. The issue came to a head in the FSX controversy when critics in Congress nearly succeeded in blocking approval of the codevelopment agreement.³² Attempts in Congress to prevent the sale of the Aegis air defense missile system to Japan also were intended to deny Japan access to advanced air defense systems and automated defense technology.

Others are concerned that Japan may eventually drop its ban on arms exports and become an instant competitor of U.S. arms export firms. They cite the views of the Japanese business association Keidanren and other industry groups in favor of relaxing the prohibition; several borderline cases of overseas sales of dual-use equipment; and the logic of exporting as defense production grows and diversifies. Indeed, some Japanese executives already feel they produce a variety of weapons, especially missiles, that would compete with U.S. counterparts for third-country markets, even if they fall somewhat

³²For details of the technology issues of the FSX deal, see John Moteff, Library of Congress, Congressional Research Service, "FSX Technology: Its Relative Utility to the United States and Japanese Aerospace Industries," CRS Report No. 89-237, 1989.

below the technological sophistication of American arms.³³

The 1983 U.S.-Japan agreement to exchange military technology, the Joint Military Technology Commission, represented an attempt to alleviate the growing perception in the United States that only Japan benefited from existing arrangements. So far, however, the results have been modest. The United States has applied for only three systems, and transfer has taken place under the agreement since 1987.

It is difficult to explain these results, which some observers cite as evidence of the failure of the transfer agreement and mechanisms. Reluctance on the part of both U.S. and Japanese companies has been cited as one cause. American firms still are unaccustomed to turning to foreign sources for technological inputs in the design and development stage, perhaps a cultural reflection of "not invented here" attitudes. Given the limited U.S. corporate presence in Japan, it is reasonable to question the extent of knowledge within industry and government of militarily applicable R&D in Japan, especially among civilian sector firms. Without extensive knowledge of Japanese capabilities, it is difficult to expect success of the arrangements established by the 1983 notes. Finally, many U.S. defense contractors still see Europe, not Japan, as their primary market, and see little justification for making corporate commitments in Japan beyond those that already exist.

Japanese companies, for their part, face similar considerations to the extent that defense technology transfers represent a departure from established business. Furthermore, despite increasing emphasis on defense-related sales, they are still concerned about antidefense public opinion, and do not wish to risk being labeled arms merchants for fear of losing commercial sales. Japanese firms, aware of the importance of technology to their own growth, may be less willing to part with vital technology under any circumstances, no matter how lucrative the financial rewards might be. Some observers have accused Japanese firms of simple greed. In the Keiko surface-to-air missile case, for example, the guidance developer, Toshiba Corp., sought \$5 million for

the technology, reflecting the company's entire R&D costs (the firm finally settled for a \$500,000 payment).

Mirroring the lack of activity through the JMTC channel is the slow pace of other codevelopment projects proposed by Japan in June 1988. Five projects were proposed for Nunn Amendment funding:

1. millimeter wave/infrared hybrid seekers;
2. ducted rocket engines;
3. armor-piercing, fro-stabilizing, discarding-sabot (APFSDS) and shaped-charge ammunition;
4. gas dynamic laser optical jamming systems; and
5. technology for analyzing and estimating magnetic fields.

The U.S. Army has indicated interest in the first two, and while finding no direct applicability in the third, nevertheless has proposed exploring cooperative projects in related areas such as electromagnetic technology. The United States apparently has little interest in the fourth and fifth areas. Japanese motivations for participating in these projects include the desire to enhance Japan's armaments and weapons capabilities, solid@ its technological base, and compensate for insufficient investments in these areas until recently.³⁴

There are several working-level panels that have helped promote relations and day-to-day contacts despite the relative lack of success at more highly publicized levels, such as the Japan-U.S. Systems and Technology Forum (STF). The bilateral panel has met roughly once a year since its establishment in September 1980, focusing on such issues as joint communications problems, bilateral technology assessments, and cooperative production programs. Although initially viewed by many Japanese officials as a means to facilitate technology transfers from the United States to Japan, the STF served as a vehicle for encouraging Japanese participation in Strategic Defense Initiative research and *exchanges* of views that led to the 1983 exchange of notes on military technology transfers.³⁵

³³ *Shimbun Shakaibu, Heiki Sangyo* (Tokyo: Asahi Shimbunsha, 1986), pp. 126-127.

³⁴ U.S. Army Materiel Command, "Assessment of Research and Development Opportunities in Defense-Related Technologies," *Report* of the Army Reciprocal Visit to Japan, September 1989, p. 5.

³⁵ See Japan Defense Agency, "Defense of Japan 1988," p. 179.

In commercial sales transactions, however, reliance on Japanese products has grown to the point that it has become a national issue. The Pentagon and U.S. defense firms are purchasing significant numbers of Japanese components for weapons systems, especially electronics components. U.S. defense companies reportedly are subcontracting increasingly with Japanese suppliers due to cost factors, and American firms are dropping out of certain segments of the domestic electronics and computer chip business.³⁶ This is a different issue, however, from that of reciprocal technology transfers, especially from Japan to the United States.

FUTURE ISSUES—JAPAN

At least four sets of issues will influence the future of defense technology relations between Japan and the United States in the early 1990s:

1. the impact of military-related technology and weapons development policies on Japan-U.S. competition and cooperation;
2. the rise of Japanese industrial capabilities coupled with the level of tensions in overall U.S.-Japan relations;
3. global security issues, especially the current changes in the communist world and in U. S.-Soviet relations; and
4. internal Japanese political trends.

On the question of the impact of Japanese defense spending increases on Japan-U.S. competition it has been noted repeatedly that Japanese business and government emphasize a far more integrated approach to defense and civilian technologies. Under these circumstances, Japanese firms are likely to benefit from cooperative programs regardless of what steps this country takes to minimize the disadvantageous aspects of technology transfers.

This circumstance points to the need for policymakers to define acceptable compromises that inevitably will involve economic, political, and military tradeoffs. Attempting to secure Japanese contributions into new codeveloped weapons systems might be a desirable policy option for the United States, but it will also mean elevating the capabilities of the Japanese defense industry and potential competition for the United States in the future. By the same token, U.S. observers should not

be shocked by Japanese proposals to acquire aircraft carriers if Japan assumes responsibility for sea-lane defense to the 1,000-mile perimeter, the policy encouraged by the United States.

Arms export resistance is strong in the Japanese public, and any government would risk a political backlash if it changed current policy. Nevertheless, there is pressure on the government to change course and each precedent may make it more difficult to hold the line on the export of complete weapons systems. As dual-use technologies proliferate and as Japanese overseas investment becomes more active, these policies will likely come under fire. The issue of exporting complete systems may become moot because of the proliferation of dual-use technologies, their reduced half-lives, and relative affordability. This would complicate U.S. efforts to manage technology flows with military applications and the growth of competitors in international markets.

MITI and MOF have remained relatively consistent in their efforts to restrict Japanese investments in overseas companies with defense production facilities. In the specific case of the United States, DoD regulations governing foreign acquisitions of companies essential to national security have influenced possible acquisitions of U.S. defense companies by Japanese firms.

Internal Japanese politics also have ramifications for bilateral relations, although to a lesser extent. Over 30 years of continuous rule by the majority Liberal Democratic Party, appears to have been reaffirmed in the March 1990 elections, despite gains by the opposition in the July 1989 House of Councillors elections. It is nevertheless possible that an opposition coalition led by the Japan Socialist Party (JSP) could come to power in the foreseeable future. A stronger, more influential opposition is likely even though these electoral gains have come primarily in the less important house. The JSP has moderated both the tone and substance of its critical positions on U.S.-Japan security relations, intimating that the party would welcome a continuation of the bilateral security treaty and would not challenge the legitimacy of the Self-Defense forces.

There will continue to be disagreements between the United States and Japan about the degree of Japanese domestic development and production of

³⁶Michael Schrage, "U.S. Dependence on Japan for Parts Worries Pentagon," *Washington Post*, Mar. 11, 1986, p. A1. The Defense Science Board examined U.S. dependency on foreign semiconductors in its February 1987 report, "Defense Semiconductor Dependency."

new, advanced weapons systems. To deal with these conflicts the United States will have to make some decisions regarding the extent and nature of Japanese participation in the cooperative development of future U.S. systems and what prices the Japanese will be expected to pay for participating in these programs. The United States may have to accept a tradeoff between the development of a potentially competitive Japanese aerospace industry and the degree of participation permitted in future codevelopment/coproduction projects.

Another area of uncertainty is Japan's ability to use military technology, including U.S.-supplied technology, in developing civilian products and clones of U.S. weapons. Japanese firms are adept at internalizing technology introduced from abroad, and likely will identify new applications for technologies unanticipated in the United States. Focusing excessively on the aircraft industry risks missing the point of a diversified Japanese long-term industrial strategy of using technological inputs from military production for everything from fishing rods to high performance aircraft.

In the U.S.-Japan context, defense-related technology transfers should not be viewed as one-on-one relationships between individual Japanese and American firms. While an American company might have extensive experience with one or perhaps two Japanese companies, Japanese firms have overlapping relations with many U.S. companies. This situation, coupled with interdependent relations through informal corporate ties and extensive subcontracting arrangements, improves the opportunities for technology diffusion throughout Japanese industry. Japanese firms have made significant progress in weapons development, particularly in the area of missiles. Industry observers generally agree that older generations of American technologies already have found their way into many of these Japanese systems by virtue of cooperative programs.

The dilemmas of coproduction are illustrated in Raytheon's experience with Japan in the Sidewinder air-to-air missile. Japan sought Raytheon's Sidewinders AIM-9B in the 1970s at a time when domestic development of a similar guidance system was a high priority for JDAs TRDI. When it became evident that the Sidewinder guidance package was not available for release to Japan, JDA and TRDI embarked on a development program that resulted in

the AAM-1, a Sidewinder replacement that was to be utilized on the domestic F-1 fighter aircraft.

The AAM-1 was in line to become JDA's favored air-to-air missile, replacing Sidewinders entirely. But the domestic guidance development was suspended temporarily once the United States indicated to the Japanese Government that the more advanced Sidewinders AIM-9L would be available for local production in Japan.³⁷ This option appealed to JDA because it would give greater access to the Sidewinder guidance and would thus promote the goal of developing domestic counterparts. MHI completed an agreement with Raytheon to license produce the Sidewinder in Japan in 1980, and JDA shifted its infrared guidance efforts from AAM-1 production to further research in TRDI.

In the meantime, advances have continued on the AAM series, and while U.S. industry experts are divided on its technological capabilities compared even with earlier Sidewinder generations, it has moved into full-scale production and has begun replacing Sidewinders on all Japanese aircraft that can carry air-to-air missiles. Raytheon, the U.S. Government, JDA, and Japanese business currently are involved in negotiations to allow licensed production of the next generation, the AIM-9M.

Any rationale for continuing cooperation in arms development in the 1990s will run up against the possibility of further deterioration of Japan-U.S. relations. The FSX controversy helped to push tensions to a new high in 1989. But disputes such as the FSX do not threaten a total rupture in bilateral relations. Their importance lies in the fact that proponents of domestic arms production renew their lobbying with each instance of perceived "Japan bashing" in the United States. Autonomy is more appealing and credible as Japanese industry grows more proficient and capable of developing alternative weapons systems. The appeal is not limited to industry: government officials, weary of perceived political pressure and inconsistent policies on the part of the United States, could side increasingly with those who favor an independent course on defense development and production.

The FSX controversy has raised opposition to joint weapons programs at several levels in both countries. If disputes over economic and trade issues escalate in the early 1990s, it is possible that neither

³⁷Koichiro Yoshihara, *Nihon no Boei Sangyo*, 1988, pp. 124-125, 130-131.

government would wish to expend the political capital necessary to promote new codevelopment arrangements like the FSX. Government and business elements in Japan, which argued originally for independent development of a fighter, may have their way in the future. Opponents of cooperation in the U.S. Government may have put the Pentagon permanently on the defensive after the FSX dispute.

This is not to suggest that the United States should shy away from articulating its own interests in cooperative arrangements if they threaten serious political conflict. However, the United States is no longer in a position to dictate the terms of participation in these programs with Japan. European firms have recognized the marketing opportunities with Japan arising out of the FSX controversies, and might be less concerned about many of the issues on which Congress focused during the FSX debate. The Japanese Government has recently demonstrated a willingness to select European systems over American alternatives, for example, an Italian patrol boat for the Maritime SDF and the British Aerospace BAE 125-800 as a flight-check aircraft. While these are isolated cases there is no doubt that European companies offer a comparable range of systems. Furthermore, it indicates the willingness of Japan to diversify its options in defense at the expense of its traditional supplier when credible alternatives exist.

U.S. policymakers must ask whether it is possible to establish a reciprocal relationship with Japan given differences in the nature of defense policies and industry contracting in the two countries. While reciprocity appeals to those in the United States who seek greater transfer of Japanese technology for use in U.S. systems, it is difficult to establish criteria for judging the degree of reciprocity in the relationship. For instance, it has been noted that in the case of the FSX program, the benefits of future technology flowbacks from Japan to the United States might be limited solely to General Dynamics (GD), the U.S. subcontractor in the Japanese-led program, not to the entire U.S. defense industry, much less the national industrial base. Furthermore, since GD's contracts are overwhelmingly military, civilian applications of any technology will be restricted.

This stands in contrast with Japanese firms that are the recipients of U.S. technology transferred

through defense programs. Major prime contractors in Japan, while increasingly emphasizing defense-related sales in their marketing strategies, nevertheless rely on such business for only a small portion of their total sales. With corporate strategies that emphasize intermingling of civilian and military technology applications, they are far more likely to benefit from defense-related and especially dual-use technology transfers through cooperative programs. The high percentage of subcontracting work, the limited number of contractors in the defense market, and overlapping relationships with U.S. firms tend to facilitate greater benefits for the Japanese partner in cooperative programs with the United States. Under these circumstances defense industrial relationships between the two countries may not be truly reciprocal.

The rapid changes in Eastern Europe and rising possibilities of improved U.S.-Soviet relations could affect substantially the priority the United States has given to the Japanese defense buildup and military cooperation with Japan. U.S. popular perception is that the Soviet threat has already declined markedly. That perception could strengthen if force reductions and other arms limitations or arms control agreements are reached with the Soviet Union in the near future. DoD officials already are referring to possible defense budget cuts of \$180 billion over 5 years if current developments are sustained. This would result in major cuts in the size of the current U.S. force structure and slowdowns in development of advanced weapons, including conventional weapons.

Under such policies, the United States may have less reason to encourage a Japanese defense buildup, but the reaction in Japan could be profoundly different. Unconvinced of peaceful Soviet intentions in the region, and that the "framework" of the Cold War indeed remains in the Asia/Pacific region, the Japanese Government has argued for holding the present course on defense spending at least for several more years. A decline in U.S. defense budgets would thus encourage industry and government in Japan to accelerate their movement toward autonomy, especially if declines are coupled with U.S. withdrawals from the region, and with additional demands for Japan to share the burden.

Chapter 5

**Commercial Implications of
International Collaboration**

CONTENTS

INTRODUCTION	<i>Page</i> 77
TRANSFER OF MILITARY TECHNOLOGY TO THE CIVIL SECTOR	77
THE POSITION OF THE LARGE U.S. DEFENSE INDUSTRIES	83
IMPLICATIONS FOR DEFENSE SUBCONTRACTORS AND SUPPLIERS	84

Figure

5-1. The Top Ten Micro-chip Producers, 1972-87	<i>Page</i> 82
--	-------------------

Table

5-1. Differences Between Military and Civilian Projects	<i>Page</i> 81
---	-------------------

Commercial Implications of International Collaboration

INTRODUCTION

This chapter provides an in-depth discussion of the question of how and to what extent transfer of military technology assists the recipient nation in increasing its technological sophistication, and in building an industry that can become competitive with the United States in nonmilitary markets. But the question of building civilian industrial capacity is only one major implication of international collaboration in military technology.

International collaboration also has direct implications for U.S. defense companies and affects various sectors of the industry differently. It promotes the short term interests of the largest defense contractors that have experience in international business and who can make the necessary investments needed to penetrate foreign markets. Conversely it dilutes the business prospects of many smaller companies that cannot establish international strategic alliances with foreign firms. Accordingly this chapter considers the different sectors of U.S. defense industry separately. Three questions are addressed:

- Does international collaboration in defense technology make it easier for foreign industries to penetrate U.S. civilian markets?
- What are the implications of increasing international collaboration for the large U.S. defense companies, the system integrators?
- What is the effect of increasing international collaboration on other sectors of the U.S. defense industry—the second- and lower-tier subcontractors and the suppliers of components for the defense market?

TRANSFER OF MILITARY TECHNOLOGY TO THE CIVIL SECTOR

Does international collaboration in defense technology make it easier for foreign industries to penetrate U.S. civilian markets?

Civilian industries are indirectly affected by international collaboration in defense technology. In general, activity that builds up a nation's technolog-

ical capability in defense will also benefit closely related technological activities in the civilian sector. How much technology “spinoff” from defense R&D actually takes place and benefits civil industry (or is developed for “dual-use” under the stimulus of a military development) is a complex question. It is complex because nation states have varying industrial policies, possess different rules that guide the defense business, are at different stages of technological sophistication, and have different levels of civil-military industrial integration (ranging from Japan, which is highly integrated, to the United States, which is largely separate).

Some technology is transferred in almost every collaborative venture. How much or how easily that process proceeds depends largely on the organizational structure of the joint project and the industrial environment in which the participants operate. Tightly controlled and highly segregated cooperative projects, such as classified military programs, tend to minimize diffusion of technology to other programs. On the other hand, technology can be transferred relatively easily within and between large vertically integrated companies with long-standing cooperative arrangements.

The United States has promoted a wide variety of collaborative efforts from information exchanges, both formal and informal, to very complex coproduction programs negotiated among several countries and their companies.¹

Technology can be transferred when two or more individuals discuss technical issues during an information or data exchange. The Department of Defense (DoD) has always encouraged and even formalized this type of exchange. On a fundamental level, data exchange can be a very effective process that leads both to personal relationships and actual knowledge transfer. In licensing, technology transfer occurs as a result of the transfer of data packages that impart to the recipient complete instructions on how to produce a certain part or component. In coproduction, personnel from two or more organizations work together to be sure that the resulting equipment meets all the requirements of the system in question. Consequently a higher level of collaboration is involved, and the possibility of technology

¹See app. B for examples.

transfer is greater. However, coproduction rarely involves state-of-the-art technology and therefore transfer of leading-edge technology is still limited.

The highest level of technological cooperation, and consequently the most susceptible to leading-edge technology transfer, is codevelopment, where the two partners work together to solve mutual problems. At this level, the opportunity for a true two-way street in the transfer process is greatest. In general, the closer technical personnel work together, the more easily the transfer process works. Consequently, the process of codevelopment, where large teams of engineering and management personnel must work together to solve mutual problems, is a fertile ground for technology to transfer in both directions, with new technology being generated and available to all parties in the agreement.

Extensive foreign military sales, licensing, and coproduction programs that the United States has conducted with its allies over the past several decades have been critical to building competitive defense industrial complexes in Europe and Japan. Starting in the 1950s and 1960s, military hardware licensing brought these countries embryonic defense engineering and production capabilities. Over the years these efforts grew toward coproduction of progressively more sophisticated and complex systems, with each new step adding to the technological capability of the foreign participants. In making policy choices about which coproduction programs to participate in, these countries made political and financial commitments that dramatically added to their total industrial capabilities. They often paid premium prices to create and maintain advanced technological capabilities domestically, through coproduction programs with the United States.² Codevelopment of military technologies that can be used in civil applications has been an openly stated goal of European governments for years. Further, through intra-European cooperation, the major European powers have developed extensive indigenous capabilities in defense technology, and have, with few exceptions, become increasingly independent of the United States.

In Japan a similar process has developed with one important difference; for many years Japan's explicit industrial policy has emphasized the acquisition of technology from abroad, mostly from the U. S., and primarily for civilian production purposes.

Further, legal restrictions and post-World War II cultural inhibitions have mandated defense technology to a relatively minor fraction of that country's industrial output. Operating under a set of coordinated industrial policies, Japan has participated in extensive coproduction programs in the aerospace and defense electronics fields. In doing so, it has significantly enhanced its industrial capabilities and has attained world leadership in important areas.

Diffusion of military technology to the civil sector is likely when it is transferred to a country that has an explicit policy to emphasize development of its civilian industries and/or to integrate its civil and military industries. This phenomenon is most apparent in Japan and Germany, where approximately 1 percent of the defense budget is allocated to defense-oriented R&D. Both countries benefit significantly through collaboration with the United States. They gain access to defense technology developed here, and they are able to concentrate on civilian-oriented technology research.

In addition, the existing close association between military and civilian manufacturing promotes the spread of military technology to the civil field. When airplane wings for both civil and military systems, or military and consumer electronics, are made side-by-side in the same factories, the possibility of technology transfer is greatly enhanced. Integrated companies that do a small amount of defense work are positioned to exploit defense technologies for civil purposes, especially in the absence of government policies, both implicit and explicit, that separate civil and defense developments. Some observers argue that U.S. companies tend to favor esoteric defense-specific technologies, while their foreign partners concentrate on dual-use technologies that can later be marketed in civil applications.

Technological development moves in many directions simultaneously, in companies, industries, and internationally. When a technology transfers from the military to the civilian sector it called "spinoff." The term "spin-on" has been coined to describe transfers in the opposite direction, from the civilian sector to the military. Both terms can be misleading. When there is a general increase in the state of knowledge in a given area, and that knowledge is applied to another application, the term technology diffusion is, perhaps, more appropriate. In addition, it is possible to develop technolo-

²The history of this process is discussed in ch. 3.

gy with the objective of applying it both to military systems and to consumer products.

Historically, defense technologies have exerted significant influence on civilian commercial developments. This has been particularly true in the United States, where DoD has sponsored a major fraction of the country's R&D in aerospace. Modern jet transport and the computer provide examples of the critical role that Pentagon R&D investment have played in the growth of important industries.³ There is abundant historical evidence that defense technology can provide strong leverage for commercial industrial developments.

Spinoff of technology from defense to the commercial sector has been primarily an American phenomenon. Whether this is so because the United States spends so much more on defense R&D than do other nations, or because of the high priority given to advanced technology in U.S. defense R&D programs, or both, is not clear. However, it is difficult to identify major spinoff successes in foreign programs. In Europe, programs like the Airbus were developed as wholly civilian operations. In Japan, major efforts, such the dramatic rise of the semiconductor industry over the last 10 years, have been directed at strictly commercial developments.

There is evidence that spinoff no longer works well in the United States. The greatest potential for transfer occurs in the early stages of R&D, when advances are generic and not product-specific. As the technology matures, commercial and military applications tend to diverge in performance and cost requirements, and the technical interchanges decrease. There are fewer person-to-person contacts, fewer technical meetings, less open journal publication, and decreased interaction on the management level. In addition, the trend in the United States

toward greater regulation of defense businesses has created additional barriers between civil and military technologies and industries.

The trend in the DoD R&D budget has been toward greater emphasis on advanced systems prototype engineering and testing, rather than on the type of applied research and exploratory development that fosters technology transfer.⁴ For example, the Strategic Defense Initiative (SDI) program has not produced significant technology transfer to the civilian sector considering the size of its operations and budgets.⁵ It would appear that defense technology spinoff is not a very active path at this time, despite legislative efforts to stimulate this type of activity.⁶

DoD has the resources and the need to invest in long-term technological developments that may have a high payoff, but also involve substantial risks and may have no obvious commercial use. DoD does this to underwrite its basic defense posture, which is to stay a generation ahead of our adversaries in technological capability. Despite the fact that these sorts of military technologies have on occasion started entire new industries, such as jet transportation and computers, civilian companies appear far less willing to invest in such high risk ventures than in the past.

The structure of most European and Japanese companies is well-suited to the sharing of technologies between civilian and military applications. In many cases, the military and civilian sectors cannot be distinguished. Military work is not a very important aspect of the total business, first because the Europeans and Japanese do less defense business than American firms since their market is much smaller, and second, because they and their governments place a much stronger emphasis on commercial business. In Japan, the country's largest military

³Both the development of the modern jet engine, originally by Whipple in Great Britain, and the modern swept-wing transport aircraft were direct derivatives from military developments. The Advanced Research Programs Agency (ARPA, now called DARPA) bought all computer technology, even that developed for civilian purposes, in the belief that priming this critical industry would accelerate the development of computer technology as a whole that would in the end benefit DoD. See Kenneth Flamm, *Targeting the Computer: Government Support and International Competition* (Washington DC: The Brookings Institution 1987); and J. Stowsky, "Beating Our Plowshares Into Double Edged Swords: The Impact of Pentagon Policies on the Commercialization of Advanced Technologies," The Berkeley Roundtable on the International Economy (BRIE), April 1986.

⁴Ashton Carter, "Analyzing the Dual Use Technology Question," Center for Science and International Affairs, John F. Kennedy School of Government, Harvard University, Cambridge, MA, November 1989.

⁵See Rosemary Nimroody, William Hartung, and Paul Grenier, *Star Wars Spin-Offs: Blueprint for a High-Tech America?* (New York, NY: Council on Economic Priorities, 1988). Despite the fact that technology transfer to the civilian sector is not strong for SDI, the European Community, and especially France, has been concerned about the potential for civilian spin-off of the SDI program. They specifically initiated the EUREKA program in response to SDI. However, EUREKA is oriented toward civilian and dual-use applications.

⁶For instance, one of five stated purposes of the Stevenson-Wylder Technology Innovation Act of 1980 was to "stimulate improved utilization of federally funded technology development by State and local government and the private sector."

contractor, Mitsubishi Heavy Industries (MHI), conducts only 15 percent of its total business in the area of defense, and defense production accounts for only 0.5 percent of Japan's total industrial output. Consequently many companies operate their defense efforts alongside their commercial work, often using the same technical and management teams. At the subcontractor level, this line is blurred further because much of their technology is dual-use and supplies both sectors.⁷

The case of the FSX fighter codevelopment project, where technology transfer in both directions was a key issue in the debate, provides an excellent example in the differences in corporate philosophy. At MHI, new technology acquired in the codevelopment process will become available to other MHI projects, including commercial ones. MHI has done this before, when it carried out F-15 coproduction efforts in parallel with its commercial subcontract work for Boeing, while concurrently developing an indigenous private corporate jet in its Nagoya Works.⁸ Conversely, technology transferred to General Dynamics under this agreement is unlikely to be shared with other U.S. companies, and certainly not with the U.S. commercial aviation industry.

In the United States, defense and commercial business organizations typically are highly segregated, even when they reside within the same corporation. Companies separate into government and commercial products divisions when they have major activities in both sectors, even in cases where the products are similar. This separation is not as unreasonable as it sounds, given that the defense and civil divisions must apply different technical approaches, different cost and performance considerations, different administrative and management systems, different types of regulation, and different customer relationship and marketing operations—adding up to profound differences in corporate culture. The coordination of the activities of such companies usually occurs primarily in the board room, which is not the best environment for the transfer of specific technological knowledge. Some

of the differences between military and civilian projects are listed in table 5-1.

In its effort to speed the development of greater capacity and faster micro-chips, DoD initiated the Very High Speed Integrated Circuit (VHSIC) program. Because of the defense-first acquisition approach used by DoD, the companies that dominated VHSIC were defense contractors, not the commercial semiconductor industry. The program generated special purpose, high capacity chips oriented to specific military projects, with little or no application to the U.S. commercial semiconductor industry.⁹ In Japan, MITI organized an industry-wide development program for high-capacity commercial micro-chips that now dominates world markets, and supplies advanced chips for U.S. defense systems. Without the separation of defense and civilian industries, the Japanese were able to channel their efforts directly to the companies that could lead them to market dominance. Figure 5-1 displays the dramatic rise of Japanese micro-chip products from 1972 to 1987, and the attendant decline in U.S. capability.

Because the military and civil aspects of European and Japanese industry are more closely coordinated and are dominated by nondefense interests, foreign companies appear better able to exploit U.S. defense technology, transferred in collaborative efforts, for civilian purposes, than their counterparts in the United States. To understand this phenomenon, it is necessary to explore the underlying causes of these differences.

The separation of U.S. defense industry from the commercial sector is a major factor. To a great extent, this artificial separation is created and enforced by U.S. laws and DoD regulations.¹⁰ Only in the United States and possibly in the Soviet Union, have defense markets been large enough to support very large companies on defense business exclusively. Twenty U.S. companies had more than \$1.0 billion of defense business in 1988.¹¹ In Japan, only Mitsubishi had sales in excess of \$1.0 billion in defense business, and that amounted 26 percent of

⁷A further discussion of these statistics is given in app. C.

⁸See ch. 4.

⁹Some observers argue that because the VHSIC program was classified, the technology could not be transferred to the civilian sector. In this view, the technology was dual-use, but the chips that were built were not.

¹⁰U.S. Congress, Office of Technology Assessment, *Holding the Edge: Maintaining the Defense Technology Base*, OTA-ISC-420 (Washington, DC: U.S. Government Printing Office, April 1989), ch. 9.

¹¹*Military Forum*, vol. 6, No. 1, August 1989, pp. 15-16.

Table 5-I-Differences Between Military and Civilian Projects

Military	Commercial
<ul style="list-style-type: none"> • Cost not as important as performance of weapons systems • Large ratio of technical to nontechnical personnel 	<p>Highly rest-sensitive</p> <p>Fewer technical personnel; less development, redesign, and emphasis on state of the art</p> <p>Standardized, mass-produced products</p>
<ul style="list-style-type: none"> • Most products custom-designed; tendency toward overdesign • Focus on state-of-the-art technology or leading edge not yet state-of-the-art • Relatively few customers, the U.S. Government and its military services, which designate how a product is designed. Products sold as a block, vendors compete once for contract. • Marketing and sales staff more dominated by engineers 	<p>More emphasis on use of off-the-shelf items to keep costs low</p> <p>Different customers with differing needs. Products sold few at a time, vendors compete for every sale.</p> <p>Concerns of marketing and sales personnel often override those of technical staff</p>
<ul style="list-style-type: none"> • Large, long-term contracts • Much time spent on proposals and in developing documentation (operating and maintenance manuals) • During design and manufacture, a need to define a variety of missions; harsh, uncertain operating environment • The customer, DoD, supplies the threat and mission requirements, while the contractor furnishes the technology; parties work together to define final work statement • Documentation done concurrently, while job is under way • Administrative and accounting systems prescribed by the Federal Acquisition Regulations (FAR) for maximum audit scrutiny • Government regulatory environment covers all aspects of operation. 	<p>Many customers, many orders</p> <p>Emphasis on specification sheets, instruction manuals, and warranties</p> <p>Predictable product life is important</p> <p>Manufacturer of equipment supplies specifications</p> <p>Documentation sometimes supplied after project completion</p> <p>Administrative and accounting done to standard commercial practice</p> <p>Regulations cover only specific aspects of operation such as Occupational Safety and Health Administration, Food and Drug Administration, export licenses, etc.</p>

SOURCE: Adapted from *IEEE Spectrum*, vol. 26, No. 11, November 1989, p. 4.

the total Japanese defense expenditure.¹² General Dynamics is 85 percent defense-dependent and Lockheed is over 90 percent. For others the defense business is large enough so that a conglomerate like General Electric can split off a defense products division as a business unit that does over \$5.0 billion per year. This part of General Electric is a government and defense-committed operation.

In recent years, the Department of Defense has contracted for approximately 150 billion dollars' worth of goods and services annually presenting major business opportunities for many companies in the United States and abroad. In order to conduct such a large business, the government has its own set of procurement rules, the Federal Acquisition Regulations, or FARs. Defense firms organize themselves structurally, and especially administratively, to conform to these regulations, which often increases costs compared with commercial projects. Compli-

ance with the FAR is one of the factors that splits U.S. industry into two sectors. Some argue that it keeps commercial high-technology companies, including innovative ones, on the sidelines with respect to DoD, while keeping defense contractors isolated. Major reform of government procurement and contract administration has been recommended by many committees and knowledgeable individuals,¹³ by Congress, and by the Pentagon,¹⁴ but little remedial action has taken place.

The ease with which technology appears to transfer from military coproduction programs to commercial ventures in Japan, and in the EC, is primarily due to the way their industries are structured, the dominance of the civil market in their overall economic policy, and the close working relationships that exist between the workers in the two sectors. There is little evidence of direct application of specific military hardware or systems

¹²See app. C for detailed data on the Japanese defense industry.

¹³For instance, see The President's Blue Ribbon Commission on Defense Management, "A Quest for Excellence," June 1986.

ids the Defense Science Board Summer 1988 Study on the Defense Industrial and Technology Base, Office of the Under Secretary of Defense for Acquisition, Washington DC, October 1988.

Figure 5-1—The Top Ten Micro-chip Producers, 1972-87

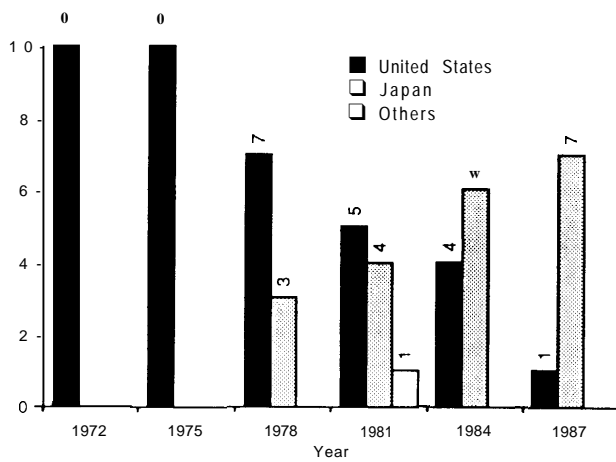

"Only eight companies in existence.

SOURCE: "Survey: Japanese Technology," *The Economist*, vol. 313, No. 7631, Dec. 2, 1989, supplement, p. 8.

to the commercial sector, but there is little doubt that the technological knowledge and experience are invaluable to the civilian sector, when the environment is right for the transfer to occur.

Conversely, when the environment is not right, the process will just not happen. It is not the availability of military technology that causes the disparity in technology transfer capacity between the United States on the one hand and the EC and Japan on the other, but rather the vast differences in the management structure and regulatory constraints of the companies.

Where American corporations have attempted to maximize technology transfer, they have gone to great lengths to create an environment for innovation and entrepreneurship.¹⁵ Loosely organized technical teams, a maximum opportunity for interdisciplinary interaction, informal organization and, above all, a free hand to innovative technologists have all been found to work well. All of these attributes are in direct opposition to the highly organized, project-specific, mission-oriented DoD approach.

Defense companies that have no commercial interests also have little incentive to keep technology with commercial potential out of foreign hands.

For example, because General Dynamics has little or no business in the civil aviation field, it would not be damaged financially if the transfer of F-16 technology to MHI aided that company in increasing market share in world transport aviation markets. Rather, General Dynamics is concerned about future direct competition in the area of military systems, and consequently, has protected several sensitive pieces of flight control software, which are critical to advanced fighter aircraft, but have little to no commercial value.

During the FSX debate in Congress, there was concern that transfer of the F-16 technology to Japan would assist the Japanese in building up an aircraft industry that would eventually compete for market share with U.S. industry. Boeing executives did not share this concern.¹⁶ In fact, Boeing has pursued a course that will materially and directly transfer technological capability to the Japanese civilian aerospace industry. Boeing's commercial airplane operations dominate commercial aircraft manufacturing with over 60 percent of the world market and a Production backlog of over 4 years.¹⁷ It is challenged by Airbus Industries, a European consortium, which during the past 10 years has made considerable inroads into the market, forcing Boeing to make progressively greater financial commitments to maintain its position and eroding some of its profitability. Boeing should be the company most concerned about the entry of yet another strong competitor, in the form of a revitalized aircraft industry in Japan.

Instead, Boeing is actively pursuing collaborative ventures with Japanese firms. It has subcontracted major components and subassemblies of its commercial airplanes to Japanese companies since the early 1970s. In 1986, Boeing and the Japan Aircraft Development Corp., a government-affiliated consortium, agreed to codevelop a new 150-seat passenger airplane, the 7J7. Under this agreement, Japan was to design and manufacture 25 percent of the new airplane in return for 25 percent of the financing. The project was dropped in 1988 due to a downturn in the market for small airplanes. The collapse of this

¹⁵See Thomas J. Peters, *In Search of Excellence* (New York, NY: Harper & Row, 1982).

¹⁶Testimony by Phillip Condit, Executive Vice President of the Boeing Commercial Airplane Co. before the Committee on Science, Space, and Technology, U.S. House of Representatives, May 11, 1989.

¹⁷See Artemis March, "The Aircraft Industry Goes Global," *Technology Review*, vol. 93, No. 1, January 1990, pp. 26-36.

venture represented another setback in Japan's ambition to develop a world class aircraft industry .18

In November 1989 Boeing announced new talks with Japan aimed at a partnership to codevelop a new airplane, the 767J, a model designed to compete with the McDonnell Douglas MD- 11 and the Airbus 340.¹⁹ Boeing has apparently made a business decision that potential for new sales represented by these agreements outweighs the threat of future competition from Japan.²⁰

The FSX codevelopment project may provide some indirect assistance to Japan in its efforts to establish a world-class aviation industry. But it is unlikely to approach the level of assistance or direct technology transfer that has resulted and will continue to result from subcontractor and joint venture relationships between Boeing and the Japanese aircraft industry. In many respects, Boeing's commercial actions make irrelevant much of congressional debate over the FSX.

THE POSITION OF THE LARGE U.S. DEFENSE INDUSTRIES

What are the implications of changes in the environment of defense technology and increasing international collaboration on the large U.S. defense companies?

Major U.S. defense companies, the prime contractors and large systems integrators, strongly support international collaboration. They have participated in the internationalization of advanced technologies and are now painfully aware of the loss of competitiveness of U.S. industries, the escalating costs of new weapons, and the declining U.S. defense market. They are concerned about political developments in the Eastern bloc countries, and the resulting instability of defense budgets throughout the world.

The largest U.S. defense companies have taken stock of their capabilities and believe that they are still superior to the competition in development of large-scale, complex weapons systems that integrate

technologies from diverse fields. Most seem to believe that they can weather the storm by rationalizing their operations and by gaining access to foreign markets, but the survival of even the largest prime contractors is by no means assured.

The market for their services is, however, declining and is likely to do so more rapidly in view of recent international political developments. The Bush administration has announced its willingness to reduce defense spending by as much as \$190 billion between 1991 and 1995,²¹ and Congress may do so even more rapidly. Confronted by what now seems inevitable, the large U.S. defense contractors have intensified their efforts to make foreign sales. Recognizing the difficulty of selling directly, they attempt to allay fears about employment and industrial development by cooperating with foreign defense firms through joint venture arrangements and other collaborative programs.

However, the outlook for sales to foreign governments is also grim. In Europe, as in the United States, the perception of a decreased Warsaw Pact threat is making it difficult for countries to sustain heavy defense spending. West Germany, for instance, has more than matched the U.S. proposal of a 2 percent troop reduction in the near term with a proposal for a 20 percent reduction in the Bundeswehr. The situation is developing rapidly and unpredictably, but it is likely that Europe will cut military expenses as much, if not more, than the United States. If present trends continue, the weapons development that occurs in Europe will be accomplished indigenously.

In the search for foreign sales, the alternative to working with foreign governments is to form alliances with foreign companies. Such activity has increased markedly in the last few years .22 U.S. defense industry is searching for opportunities where its special strengths produce a good fit with European and Pacific Rim defense-oriented companies or teams. These alliances can take the form of teams, joint ventures, subcontracting, suppliers of subsystems or other business arrangements. Just as

¹⁸For a detailed discussion of the Japanese aircraft industry see, Richard J. Samuels and Benjamin C. Whipple, "The FSX and Japan's Aircraft Strategy for Aerospace," *Technology Review*, vol. 92, No. 7, October 1989.

¹⁹See Louis Uchitelle, "A Japanese Strategy for Boeing," *New York Times*, Nov. 3, 1989, p. D-1.

²⁰Some analysts believe that the U.S. aircraft industry is following the path of many other U.S. industries and will lose out in the world market due to the lack of modernization of the industry. See March, op. cit., footnote 17.

²¹Richard Cheney, Secretary of Defense, quoted in Stephen Engelberg, "AirForce Offers To Close 15 Bases and Scrap Missile," *The New York Times*, Nov. 19, 1989, sec. 1, p. 1.

²²See Sandra Sugawara, "Defense Firms Take a Global Offensive," *Washington Post*, Oct. 22, 1989, p. H-1.

foreign companies search for niche opportunities in the U.S. defense market, American companies are searching abroad for opportunities to obtain a foothold.

When companies work closely in international collaboration it is inevitable that technology is transferred. The technology which the U.S. companies import into U.S. contracts is often very advanced and can be superior to that available in the United States. Frequently, international collaboration also introduces U.S. companies to foreign dual-use products, which are sold throughout the world with few export control restrictions. These products are often cheaper than their U.S. counterparts, and thus help the prime contractors reduce and control costs. Technology exchanges are definitely part of the process, and one of the incentives for teaming. For the large U.S. defense systems contractors, the alternative to overseas marketing and collaboration is a severe drop in business, which many of the participants might not survive.

IMPLICATIONS FOR DEFENSE SUBCONTRACTORS, SUPPLIERS

What is the effect of increasing international collaboration on other sectors of the U.S. defense industry, the second- and lower-tier subcontractors and suppliers of components to the defense market?

The **increasing** internationalization of defense business and markets creates a significant cost for smaller and medium-sized defense companies in the United States that depend on the prime contractors for subcontract business. When the prime contractors create teams and make deals with foreign companies, they agree to use foreign technology in subsystems and components, and even to license or coproduce them in offsets arrangements, all as part of the bargaining process. Consequently, the middle- and lower-tier U.S. defense contractors and suppliers, the makers of radars, flight control systems, guns, landing gears, electronic components, sensors, and even smaller subsystems and components, lose business to their foreign competitors.

Furthermore, the smaller defense firms, which perform a large fraction of the actual work on U.S. defense contracts, generally cannot afford to market overseas and are not well positioned with respect to foreign competition. Many deal in technologies that are widely available abroad. They face competition from industries supported by foreign governments in the area of dual-use technology, and they have problems in obtaining support for their R&D to sustain leading-edge technologies and innovative programs. In general, DoD does not deal directly with this group, but only indirectly through the prime contractors. As foreign companies penetrate the U.S. defense market, as subcontractors to U.S. primes, as competitors through direct bids, or through the acquisition of smaller U.S. defense firms, U.S. second- and lower-tier companies face stiffer competition.

Many smaller defense contractors see national policies that favor and support the large internationally oriented companies as a threat to their existence. They feel competitive pressures acutely as the large prime contractors eliminate marginal domestic suppliers, turn to foreign firms, or rationalize operations in response to anticipated budget reductions. Consequently, as an industry they have appealed to the Federal Government to protect them from international competition.²³ Some **claim that the policy of waiving "buy-American" restrictions in international collaboration with our allies results in direct losses to them. They believe that this tilts the playing field against them, because foreign bidders are not directly bound by costly DoD procurement regulations. In addition they assert that U.S. export controls, as well as foreign protectionist practices, keep U.S. lower-tier firms from bidding successfully for foreign subcontracts. In this view, the U.S. Government provides little support for small defense exporters, and U.S. export restrictions represent a significant barrier to their business.**²⁴

One industry association has brought suit against DoD to force compliance with the Buy American Act of 1933, as amended by 41 U.S.C. 10(a-d).²⁵ Under bilateral Memoranda of Understanding the

²³There have been a number of cases where Congress has enacted laws that specifically protect small segments of the defense industry, usually as the result of strong lobbying efforts. A number of these cases have been reported and analyzed. See "The Impact of Buy American Restrictions Affecting Defense Procurement," report to the U.S. Congress by the Secretary of Defense, July 1989.

²⁴The hearings of the U.S. House of Representatives Committee on Banking, Finance and Urban Affairs, Subcommittee on Economic Stabilization@ Apr. 18, 1989, held to hear comments on the FSX joint development agreement with Japan, brought out many of these arguments.

²⁵The National Council for Industrial Defense, Inc., Plaintiff v. United States Department of Defense and Dick Cheney, Secretary of Defense, Defendants. Civ. No. 88-0949 NHJ, Executed Sept. 26, 1988.

Secretary of Defense has granted blanket waivers from the Act for all foreign military purchases under the MOUs. The plaintiff alleges that these waivers are illegal, and its brief gives numerous examples of U.S. contractors that have lost business to foreign competitors due to actions under these waivers.

The subtier defense companies also assert that they are damaged by offset agreements between the prime contractors and their foreign collaborators. Offsets allow a purchasing nation (or company) to reduce or eliminate a balance of payments deficit arising from a particular sale of defense equipment. In general, the seller agrees to buy goods or services to 'offset' a negotiated percentage of the cost of the equipment in question. Offsets can be direct, in which case they involve work directly on the product covered by the purchase, i.e., a subcontract with the buyer to produce some portion of the system, or they can be indirect, in which they can be any unrelated purchase from that company or country, i.e., effectively a case of barter.

Offsets are specifically defined when companies, parties to an international sale, reach agreement to supply products or services. The large defense contractors use the promise of offsets to achieve a favorable bidding position when competing for foreign business. However, these arrangements create difficulties for the lower-tier contractors, which now have to bid into a situation to which the primes have already contractually agreed, i.e., they have agreed to return a certain fraction of the sales price to the buying country in the form of subcontracts. In addition, prime contractors frequently agree to purchase parts originally transferred to foreign companies under an offset agreement for later domestic production.

The middle-tier defense companies also assert that foreign firms have advantages over the U.S. companies in head-to-head competition. Defense-oriented U.S. companies bid under DoD procurement regulations, either because the prime contractor requires it, or because the company is operated under the U.S. Government audit system. The administrative overhead of complying with these government-directed practices can be very high, easily as much as 20 percent of the contract price. Foreign companies operating under different rules may have a significant price advantage in such a competition. On the other hand, prime contractors claim that foreign contracting practices must be

approved by the Defense Contracts Administration Service (DCAS) and, therefore, must be equivalent to U.S. practices.

Further, subcontractors claim that they must operate under government mandated quality control requirements that are complex and frequently outdated, and that foreign bidders must satisfy less stringent rules. The prime contractors rejoin that all foreign components must be qualified in the same manner that domestic components are qualified. There is considerable uncertainty about the level of subcontract or component purchases to which U.S. quality control standards are enforced. Subcontractors have proposed that each foreign bid should be justified by an impact statement that assesses the intangible cost advantages of the foreign bid, and levies an appropriate surcharge against that bid.

U.S. high-technology companies assert that their business potential is restricted by U.S. export policies and, consequently, they are at a disadvantage with respect to their foreign counterparts. In particular, the dual-use product, and third country re-sale restrictions of U.S. export laws, create serious barriers for U.S. companies wishing to participate in the world market. Products that are readily available abroad and traded with few restrictions by other nations are often restricted by U.S. dual-use export controls. Further, many countries are not willing to guarantee that products will not be resold to restricted countries. For this reason, many avoid U.S. products. Many innovative small and mid-sized high-technology companies in the United States decline defense business because the added administrative problems would distract them *from their primary* mission. Consequently, these companies are not direct participants in the U.S. defense industrial base.

Despite these arguments, it is not a foregone conclusion that the smaller, subtier, defense subcontractors lose when international collaboration in defense technology is increased. Subcontractors depend for most of their business on the large systems' prime contractors. They do relatively little work directly for the Pentagon. Consequently, if internationalization brings the primes more business, or even if it lets them sustain their business in a period of falling budgets, the subcontractors may also profit. The limited data on this subject is ambiguous.

Appendixes

Organizational Structures for Cooperation

Defense Technology Collaboration in NATO

Within NATO, international cooperation in defense technology and weapon systems mainly takes place in three areas: under the NATO Infrastructure program; within the Conference of National Armaments Directors (CNAD); and in selected agencies known as NATO Production and Logistics Organizations (see figure A-1). The organizations and functions of each are described in the following paragraphs.

NATO Infrastructure Common Funding

Of the 18 major NATO committees, only 2 directly control major NATO procurement funding and may intervene in procurement actions. The Infrastructure Committee reviews and approves candidate infrastructure programs, and the Payments and Progress Committee is responsible for their procurement.

The NATO Infrastructure Program provides a fully committed funding source for construction of wartime facilities dedicated to NATO use. Of the 13 approved categories eligible for NATO common funding, collaboration in defense technology involves only 3:

- **Communications, which includes military communications**, both ground and satellite, and connections with member governments.

- **Warning Installations**, which includes all forms of common use air defense and early warning.

- **War Headquarters**, which includes static and mobile command systems.

The Infrastructure Program is funded by the 13 NATO nations having committed military forces, and France participates in selected Command, Control, Communications, and Intelligence programs.

The process for programming, funding, and implementing an infrastructure project is highly structured. The nations negotiate a 6-year financial ceiling based on proposals by the Major NATO Commanders, i.e., Supreme Allied Commander Europe, Supreme Allied Commander Atlantic, and the Allied Commander in Chief Channel. The 6-year ceiling is a binding commitment to contribute throughout the 6-year period.¹

In this environment, collaboration in defense technology is a byproduct of acquisition. Procurement, even of complex high-value systems, continues to be based on fixed price, with some variations. In the bidding phase the infrastructure procurement process is governed by International Competitive Bidding (ICB) procedures originally conceived to guide the construction of airfields and other brick and mortar projects. In the execution phase a host nation is assigned responsibility for procurement.

Figure A-1—NATO Committees Dealing with Armaments and Technology

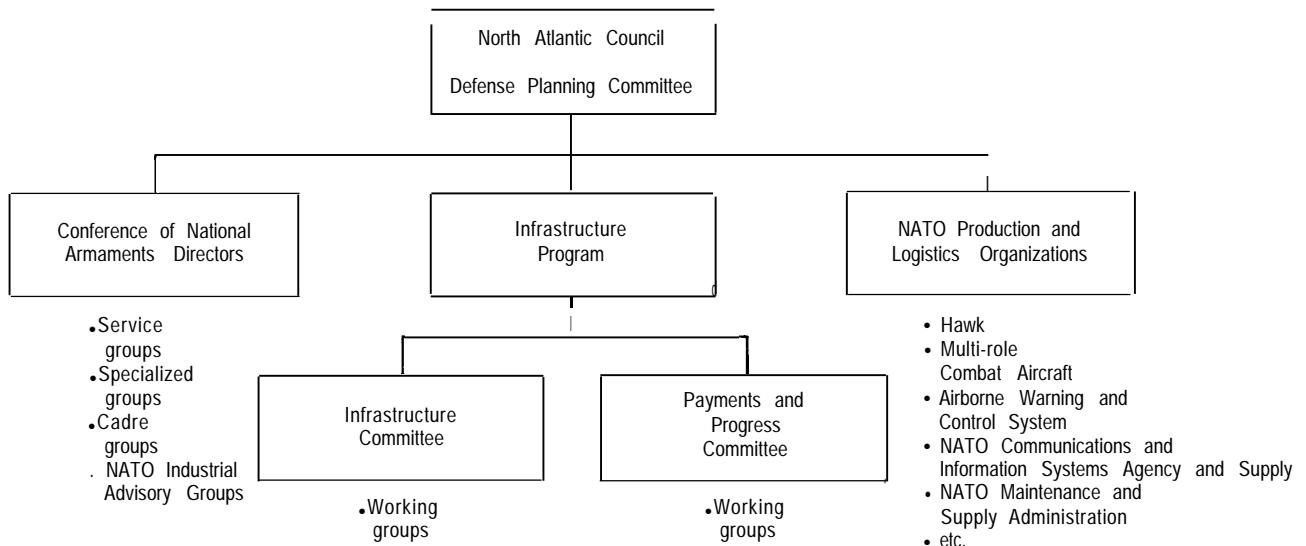

SOURCE: Office of Technology Assessment, 1990.

¹The current 6-year group of annual programs or slices (1985-90) was agreed on at a level of 3 billion International Accounting Units, or about \$12 billion at present exchange rates. On the average, between 35 and 40 percent of the program is assigned to advanced technology projects.

Figure A-2—Armaments Planning and Cooperation

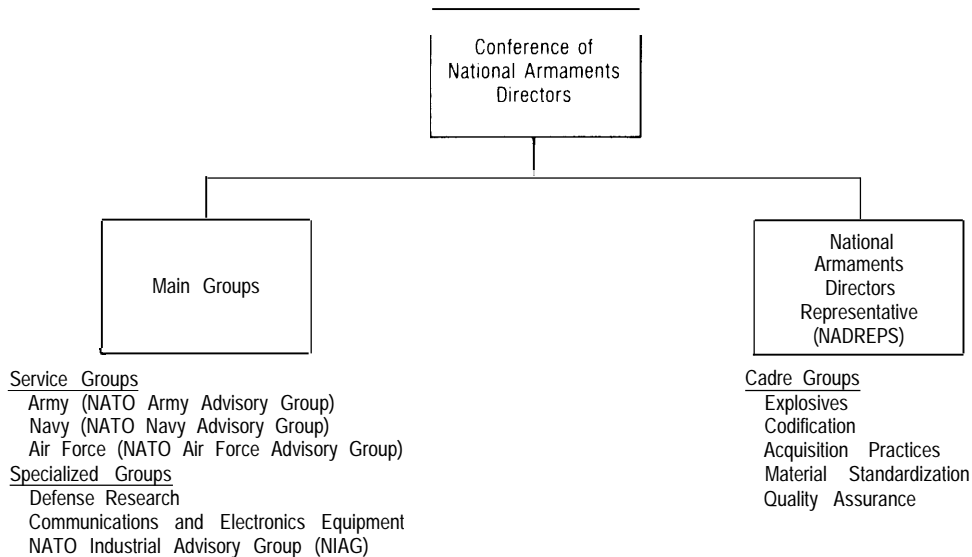

SOURCE: Office of Technology Assessment, 1990.

Host nations can be contributing NATO nations, NATO agencies, military authorities, or other bodies. Either agency or national procurement procedures are used, but are modified by the ICBs. The guiding principle is avoidance of discrimination, implicit or overt. In spite of repeated efforts to bring procedures into line with the technological realities, the nations have not been willing to delegate the necessary authority.

Nevertheless, increasing emphasis on advanced technology made it inevitable that a way be found to inject greater flexibility and professionalism into the NATO systems procurement process. One step in this direction was the September 1989 North Atlantic Council decision to create a NATO Air Command and Control Management Agency to implement a sophisticated multibillion dollar air defense system [the Air Command and Control System (ACCS)]. This multinational effort is to be funded through a combination of national and NATO Infrastructure funds and will require the involvement of the Infrastructure committees and the ICB. Present estimates place the total cost of the ACCS at about \$25 billion. The task simply seems too complex and costly to make lowest acceptable bidder a practical guideline. Successful implementation of ACCS may require that individual Alliance members give up their traditional control of complex system acquisitions.

Conference of National Armaments Directors (CNAD)

Armaments cooperation under the NATO umbrella is in its third phase since the end of World War II. In the first phase (1951-58) the nations participated in so-called Correlated Production Programs, characterized by a relatively free exchange of available designs and know-how. The aim was early and quick production and it was unhampered by national military turf protection and the “not-invented-here” syndrome. It was doomed by rising nationalism in Europe and gave way to the second phase (1959-66), which focused on cooperative programs based primarily on NATO Basic Military Requirements. These were logical but inflexible. The third phase (1966-present) was launched with the creation of the Conference of National Armaments Directors (CNAD), a committee reporting to the North Atlantic Council, thus bringing in the French, and comprised of the member nations’ chief procurement officials. NATO was shifted into the role of coordinator and facilitator. The new approach offered greater flexibility to nations, in fact so much that some structure eventually had to be given to the process.

If a structured approach to acquisition and careful attention to ground rules are the earmarks of the Infrastructure Program, free-form collaboration has characterized NATO armaments cooperation. If two or more countries agree to initiate a project, it counts as a NATO project. As it evolves, others may join under terms worked

out with the original members. Nations may stay with a project from its initial stages to the point of production, or they may drop out at any time. The projects are held together by project-specific memoranda of understanding between the participating nations; there is no commitment to or through NATO as an organization.

The CNAD's subordinate structure includes scores of committees and special groups, but most of the cooperative activities fall under one of six Main Groups (figure A-2). These include one for each of the three services (Armament Groups) plus a special group on defense research and another on communications/electronics equipment.

The sixth group, the NATO Industrial Advisory Group, is composed of representatives of national defense industries, who provide industrial advice to the CNAD and the Main Groups and carry out studies in connection with CNAD projects. There are also numerous Cadre Groups that deal with cross-cutting subjects affecting the activities of the Main Groups. Ad hoc groups are formed as needed to address special one-time issues.

Both the Main and Cadre Groups have subordinate bodies called sub-groups, panels, information exchange groups, working groups, and study groups. A special form of the subpolicy-level activity is the group of National Armaments Directors Representatives. These are members of national delegations resident in Brussels who meet

every week (or more often if necessary) to deal with current issues and to act on behalf of armaments directors on new proposals or to followup CNAD's semiannual meetings.

While the CNAD structure was explicit, the process for cooperation was not, resulting in a great deal of activity and few results. There were a number of successful CNAD sponsorships, including the Anglo-French helicopter, the Multi-Role Combat Aircraft, the 155-mm Towed Howitzer and the Milan Guided Anti-Armor Weapon. However, these programs were largely formulated outside of NATO and brought, after the fact, to the CNAD for its blessing as NATO projects.

By the mid-1970s, it became clear that greater order was needed in the Alliance acquisition process. As a result, a new procedure known as the Phased Armaments Programming System (PAPS) was established by CNAD in 1981 to deal with spiraling defense costs and persistent economic and budgetary problems in nations. Reducing duplication and increasing economies of scale through joint efforts were seen as possible solutions to these problems.

The essence of PAPS is an orderly arrangement of phases and milestones to track performance by participating nations. At the milestone points, a project can be evaluated with a common review process and agreement on the phase can be secured. Both the milestones and the



credit Department De

Th al E pean M m Al MR an ar m cce E pean co

phases are aligned with nations' internal acquisition systems, including the Department of Defense system as set down in DoD Directive 5000.1. While PAPS has been implemented successfully, it still depends largely on luck, i.e., that national requirements and schedules line up. This deficiency is now being addressed by the NATO Conventional Armaments Planning System.

NATO Production and Logistics Organizations

The CNAD and its standing groups do not manage projects directly; rather, project work is the responsibility of the participating countries. These country groupings are temporary, enduring only through the life of the specific project. However, in some cases, the countries may hand over the management to a NATO Production and Logistics organization (NPLO) for long-term implementation. Examples of successful NPLOs are the NATO Hawk Management Organization, the NATO Airborne Early Warning and Control Program Management Organization and the NATO Sidewinder Production and Logistics Organization. These system-oriented bodies may disband on completion of the project. Some, like Hawk and NATO Seasparrow, have continued to handle successive versions of the system.

The Eurogroup

In 1969, 11 European NATO countries (not including France and Iceland) joined under a flexible structure to harmonize operational concepts and to cooperate in weapons production and logistics. This was not only an effort to find a common solution to the cost escalation of military systems but also a recognition of the American desire for an increased European defense effort. Spain joined when it became a member of NATO in 1985. The Eurogroup (see figure A-3) functions as an informal, noninstitutionalized grouping at the levels of Minister of Defense, NATO Permanent Representative (Ambassador level) and senior advisers on defense issues in the various national delegations to NATO. The chairmanship is rotated and informal administrative support is provided by the British Delegation at NATO Headquarters.

The work of the Eurogroup is carried out by subgroups that operate as ad-hoc committees. The Eurogroup operates within the framework of the NATO integrated military structure, even though it is not legally a part of NATO. It has contributed to NATO defense policy, operational concepts and joint logistic and training activities. The two most significant activities of the Eurogroup have been the European Defense Improvement Program, which involved a special European contribution to NATO Infrastructure of over \$1 billion, and the formulation of Principles of Cooperation on Defense

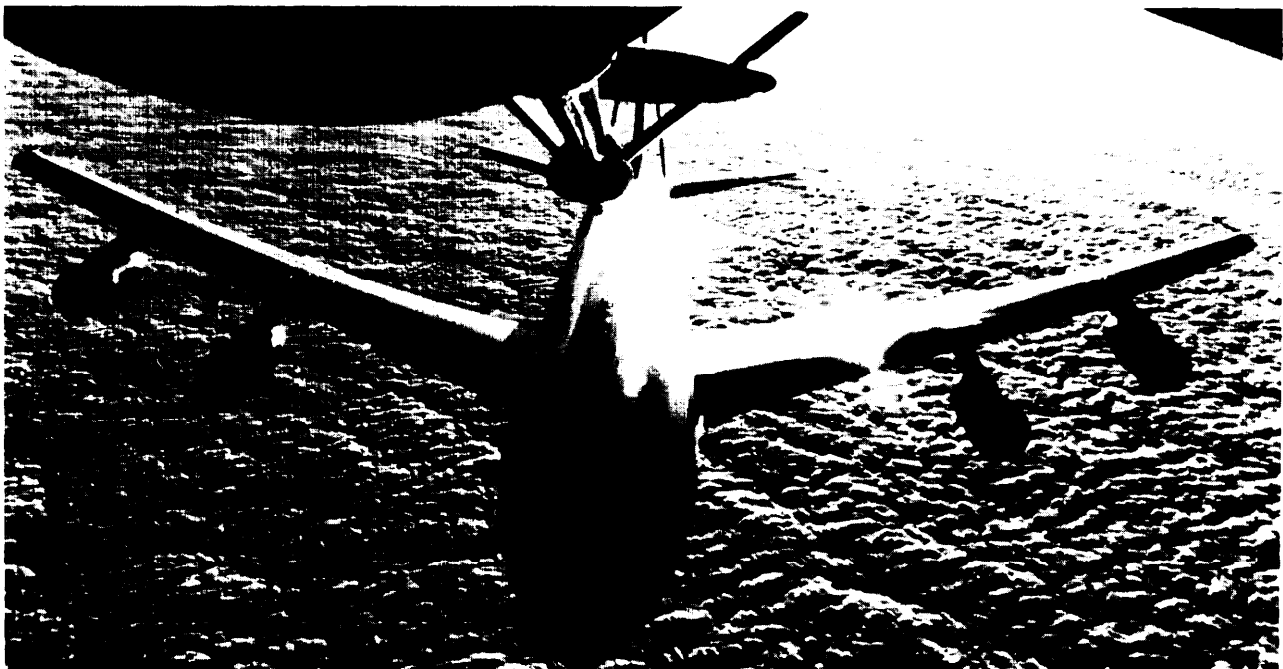
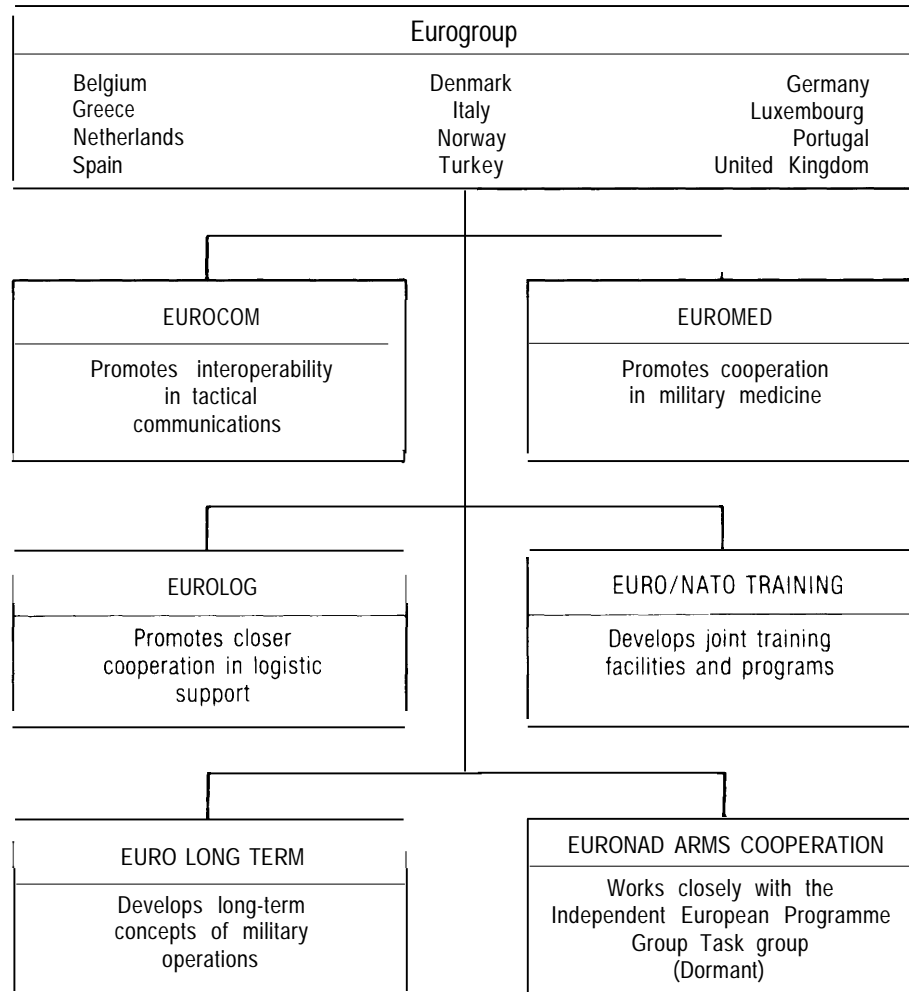

Photo credit: U.S. Air Force

Refueling of a NATO Airborne Early Warning plane, which is based on a Boeing E-3A aircraft, and contains radar technology similar to the U.S. AWACS.

Figure A-3--Eurogroup Organization



SOURCE: Office of Technology Assessment, 1990.

Equipment. The Principles have formed an important part of the policy basis for NATO cooperation in the development and procurement of military equipment. They were formally adopted by the CNAD as NATO Guidelines for Improved Equipment Collaboration.

Independent European Programme Group

In spite of the importance of its objectives, the Eurogroup did not become a major factor in the processes of European defense integration and armaments cooperation. France, one of the leaders in European defense production, had departed from the NATO integrated military structure a few years before the Eurogroup was formed, and maintained this position in spite of efforts by Eurogroup countries to draw it into their work on armaments cooperation.

In November 1975, the Netherlands Minister of Defense invited the Eurogroup countries to meet in a special Ministerial session in The Hague. They established a new organization, the Independent European Programme Group (IEPG), which could negotiate with the United States on the cooperative development and production of defense equipment. They also offered the French a place within the organization, which the French accepted. The IEPG was created to specialize in armaments cooperation.

In the first meeting of the IEPG, the representatives adopted the following objectives:

- more effective use of defense resources,
- emphasis on standardization and interoperability,
- maintenance of a sound European defense industry and greater attention to technological excellence,
- unity in negotiation with the U.S.

The Group would work to harmonize national planning for replacement of military systems, undertake joint projects, and eliminate duplication of weapons production.

The IEPG set out to do for NATO Europe what NATO had, thus far, not been able to do for its broader membership, that is to take concrete steps toward rationalization of the complex business of defense systems procurement. It proved to be more than the IEPG countries were ready to take on in 1976, The European defense industrial base was fragmented and the United States dominated most weapons fields. The IEPG members focused on bilateral deals with the United States rather than intra-European collaboration,

In 1984, the IEPG met at Ministerial level for the first time and made some important decisions. The Ministers agreed to make a thorough review of operational requirements and a greater effort to harmonize them. They agreed not to duplicate existing developments of other countries. Collaboration was to be carried back into the basic technology in the form of Cooperative Technology Projects. They also launched the European Defense Industry Study (EDIS).

One of the main issues addressed in the EDIS was the lack of a broad-based European defense technology base. The EDIS Group members argued for a broad joint research effort to build such a base, and broad collaboration in development and production keyed to coordinated national requirements.² After an initial guarded reaction, the Ministers instructed the IEPG National Armaments Directors to produce an action plan that would form the basis for the gradual evolution of a European armaments market. They also accepted the EDIS recommendation to establish a small permanent secretariat in Lisbon. The IEPG organization is depicted in figure A-4.

Building on the work of a number of ad hoc groups composed of defense officials from all the IEPG member countries, IEPG Panel 3 (Defense Economics and Procedures) presented the Ministers with a comprehensive European Armaments Market Action Plan at their meeting in November 1988 in Luxembourg. In its annex (not made public), the plan lists 40 concrete measures to be implemented in the near-term. Ministers agreed to the measures and committed themselves to review progress periodically. The main features of the plan were:

- . action toward a step-wise buildup of a European arms market,
- removal of obstacles restricting cross-border competition,
- . full exploitation of European resources and research activities, and
- . inclusion of Less-Developed Defense Industries in arms cooperation.

At the same meeting the Ministers specifically agreed to:

- institute measures to increase bidding opportunities for all member-nation companies, including the alignment of bidding and contract procedures,
- designate contact points within national procurement agencies,
- establish an information system for technology transfer, and
- set up a new IEPG Panel on Research and Technology to develop a European Defense Technology Program.

As a result of the work of the new panel and a parallel French initiative, the IEPG Ministers approved, in June 1989, a permanent defense research program modeled on the civilian EUREKA research effort, called the European Cooperative Long-Term Initiative for Defense. It will be funded at 120 million European Currency Units or \$135 million in 1990. Eleven high-priority areas have initially been designated for study: radar, microelectronics, integrated avionics, artificial intelligence, optoelectronics, electric gun, directed-energy weapons in support of Strategic Defense Initiative, advanced helicopter design, smart munitions, identification friend or foe, and military simulation.

Most recently, the IEPG has formed a panel to analyze how Europe's drive to create a unified market by the end of 1992 will affect arms procurement in the 13 IEPG countries. The panel to examine the European Community's (EC) single market program will consider such issues as the EC proposal to standardize national defense tariffs and to conduct oversight of cross-border mergers between large companies.

The Western European Union (WEU)

In In March 1948, the Foreign Ministers of Belgium, France, Luxembourg, The Netherlands, and the United Kingdom met in Brussels to sign the treaty that established the WEU. This was followed in 1954 by the Paris Agreements, which brought the Federal Republic of Germany and Italy into the organization. They also created a WEU Council, a Parliamentary Assembly, and an Armaments Committee. The Committee was to provide a focus for cooperation in arms production and procurement. It was never able to compete with the far broader database of the institutions of NATO, or later with the IEPG. *Generally* overshadowed by NATO and the European Community, the WEU went into a long period of dormancy.

In 1987, the Foreign and Defense Ministers of WEU met in Venice to revive the organization and to find anew

²Independent European Programme Group, "Towards a Stronger Europe," vols. I and II (Belgium: NATO Headquarters, 1987).

Figure A-4—Independent European Programme Group (IEPG)

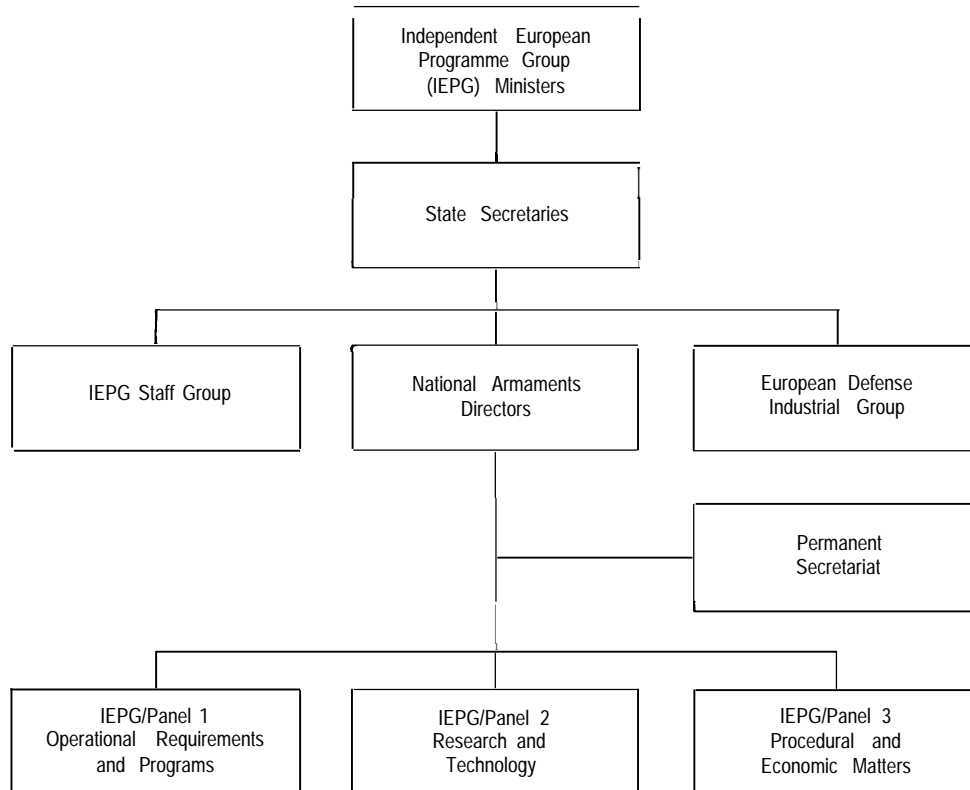

SOURCE: Office of Technology Assessment, 1990.

role for it as Europe began the process of closing ranks. The reason for relaunching WEU was to establish an organization that could act as an executive committee of the European Allies, promoting integration of the different European national armaments industries.

The function of the WEU as a catalyst and inner forum seems reasonable; but it cannot be expected to play any significant role in the movement toward European defense industrial integration. Its membership does not include all of the players and it lacks the essential connection to unified military planning. Even those who see a larger role for a WEU augmented by newly created agencies concede that its work should be within the NATO framework. The WEU Platform on European

Security Interests, approved in 1987, suggests a defense role for the EC in paragraph 2, which states:

We [the Foreign and Defense Ministers of the Member States of the WEU] recall our commitment to build a European union in accordance with the Single European Act, which we all signed *as* members of the European Community. We are convinced that the construction of an integrated Europe will remain incomplete as long as it does not include security and defense.

References in the Platform to military and armaments cooperation failed to mention the IEPG.

Appendix B

Techniques and Mechanisms for Cooperation

Security Assistance

The Security Assistance Program

The U.S. Security Assistance Program was established on the principle that the security and economic wellbeing of friendly governments are vital to U.S. interests. This activity provides for military and economic assistance, including: the sale, grant, lease, or loan of equipment; technical assistance; military education; and training. Programs are managed by the Department of Defense and the Department of State. DoD programs are administered by the Defense Security Assistance Agency (DSAA) and include:

- . Foreign Military Sales (FMS)
- . Foreign Military Sales financing; and
- . The International Military Education and Training program.

The programs administered by the Department of State are:

- The Economic Support Fund;
- . Peace-keeping Operations;
- Commercial export sales licensed under the Arms Export Control Act.

Under the FMS program, DoD serves as a contracting authority to foreign governments that wish to buy U.S. equipment. DoD provides information on weapons capabilities, establishes procurement mechanisms, and ensures that the systems, once delivered, can be operated and maintained. The degree of interaction between the U.S. military and technical personnel and their foreign counterparts is substantial. Although the receiving government is responsible financially, significant technical and industrial commitments are made in turn by the United States.

The majority of DoD's technical assistance efforts are coordinated by the DSAA, one of its tasks under the overall U.S. Security Assistance Program.¹ These activities are normally tied to specific weapons or systems and, generally, the objective is to develop in-country capabilities to independently maintain and operate the U. S.-supplied equipment. Accordingly, manufacturing know-how and detailed information on designs and technologies are not involved in the agreements. However, some agreements are long-term and naturally serve to establish country-to-country relationships that may evolve into other forms of cooperation.

Foreign Military Sales Activities

Because of its long-standing legislative backdrop, the Foreign Military Sales program operates under established and well-documented procedures. If a foreign country decides to consider acquiring U.S.-developed equipment through FMS, it requests an initial cost from DSAA, known as Planning and Review (P&R) data. If, based on P&R data, the country wishes to pursue the matter further, it will request Price and Availability (P&A) data. The P&A data should provide enough detail to permit further agreement to proceed. This agreement is embodied in what is called a Letter of Offer and Acceptance (LOA), the document used by DoD formally to offer to sell defense equipment or services to requesting countries. The LOA includes a description of the equipment or services, the estimated costs, the terms and conditions, etc. Rigorous timeframes are generally imposed on the preparation, review, and approval of FMS documents, both to protect the parties involved and to abide by the appropriate legislation.

During the 1960s, FMS was used extensively by our Allies. Today, governments, especially the Europeans, have become more sophisticated in their weapons procurement and often prefer to acquire through commercial arrangements. Purchasing governments must also pay for the cost of FMS services, adding to the cost of the equipment. Finally, using the U.S. Government as the contracting authority eliminates the flexibility associated with negotiating directly with U.S. suppliers. On the positive side, under FMS the U.S. Government is responsible for the contracting and for assuring that the equipment or service meets pm-agreed requirements. If there are contractor problems with delivery or performance, DoD is responsible for their resolution. FMS is still a viable alternative for less advanced countries in the Middle East, the Pacific Rim, and other regions.

Information Exchange

Information exchange takes place informally, through bilateral military, engineering or scientific discussions, Personnel Exchange programs, organized conferences, or through formal bodies such as information exchange groups within NATO's Conference of National Armaments Directors. The bulk of these activities are conducted either through Data Exchange Agreements or Information Exchange Programs. Participants are usually not required to advance into other, more rigorous forms of cooperation, although this occasionally does occur.

¹If technical assistance is provided in conjunction with the FMS sale of U.S. equipment, the receiving government is obligated to pay the cost.

Data Exchange Agreements

Military departments or defense agencies initiate and conduct activities under Data Exchange Agreements (DEAs). DEAs do not require review and approval by the Office of the Secretary of Defense, nor do they require much in the way of funding (e.g., personnel costs, travel, data analysis, and data processing). They can cover nearly any subject, ranging from general categories of warfare and tactical concepts to specific technologies.

DEAs are usually managed by an individual whose specialty lies within the subject area. He may be located at a field command, an R&D center, a Service laboratory, or an operational command. While DEAs are tracked at Service Headquarters, only broad direction is provided at that level. This is not surprising; each Service may have scores of DEAs active at any time. They are considered a normal method for maintaining communications with Allied military counterparts on tactics, requirements, weapons, and technologies.

DEAs have occasionally evolved into cooperative R&D programs, but this is not their stated purpose. They are mainly a means for military-to-military cooperation and are usually confined to the military departments with little or no interactions with industry. They are also personality dependent, with some DEA managers working aggressively with their Allied counterparts and some less demanding—and the results are correspondingly greater or less. When DEA managers are transferred, the work can come to a virtual stop until someone with sufficient interest and motivation is assigned. This is a significant weakness, due largely to the bottom-up nature of most information exchange.

Coproduction/Dual-Production

Next to FMS the most widely used forms of government-to-government equipment cooperation are coproduction or dual-production agreements. Unlike security assistance, which is highly structured, these agreements are flexible and are tailored to each situation. In some arrangements (e.g., the F-16 European coproduction program), provisions are made for dual-production lines for subassemblies, components, and final assembly. Components manufactured by one partner may find their way into the final system of another, and no one partner may make all components. Manufacturing specialization may also be achieved. For example, in the case of Airbus and Tornado, one partner manufactures a particular component or sub-assembly for all the partners, providing economies of scale.

For dual-production or coassembly variants, the entire manufacturing process (for all components and subassemblies) and/or final assembly may be conducted at different locations. Dual-production/coassembly schemes eliminate the benefits of economies of scale (i.e., a single,

high-volume production line), but provide for alternate sources for international competitive procurements. The Sidewinder and Stinger production programs are examples of dual production; the missiles were manufactured both in Europe and the United States.

Sizable political and financial commitments by the participating governments are required for successful coproduction agreements. If the item to be produced is U.S. designed, complete data packages (*including* design data and manufacturing know-how) must be transferred to the receiving countries and their industries. Manufacturing, system integration, and final assembly will be performed outside of the United States and the foreign participants must ultimately know the system almost as well as their U.S. counterparts. Although advanced technology does not necessarily transfer under coproduction agreements, a general improvement is likely in Allied competence in related design practices and technologies. While the transfer of these capabilities may raise security or competitiveness issues, there are positive effects as well. As foreign governments and industries become more familiar with the features of the item being coproduced, improvements may evolve that can flow back into the United States, thus improving U. S.-produced equipment or systems.

Memoranda of Understanding

The principle mechanism for U.S./allied coproduction is through a Memorandum of Understanding (MOU), signed by all participating nations. MOUs are also used for most other collaborative efforts that involve a financial commitment by the participants. There are general MOUs that promote defense trade between the United States and individual nations, and there are program-specific MOUs that may cover different phases within a single program. For example, an MOU may be executed to conduct concept formulation studies for a major new weapon system. Once completed, a new MOU will be executed for project definition or engineering development, and a subsequent MOU would cover coproduction activities. New partners may join at any stage, or others may drop out.

Negotiating and concluding Memoranda of Understanding is a complex process in DoD. The Undersecretary of Defense for Policy has the responsibility (under DoD Directive 5530.3) to oversee the entire international negotiating process, and DoD negotiators (usually in the military departments) are delegated the authority to conduct negotiations, with a separate authority to reach agreements. Coordination is also required on MOUs with the Department of State and often with the National Security Council. Additionally, as the economic implications of armaments cooperation have become more important, consultation with the Department of Com-

merce and the U.S. Trade Representative has been initiated.

Negotiating and concluding an MOU for coproduction (or codevelopment) is becoming a major task for Service program managers. Not only must they balance U.S. and foreign interests, but they must find a way to resolve the various concerns and interests within the U.S. Government.

Codevelopment and Program Packages

The most difficult and intense form of cooperation is codevelopment. Close associations are needed, often requiring the formation of integrated, multinational design teams and a significant transfer of technology and know-how among partners. As with coproduction, codevelopment programs can take on different characters, depending on the nature of the design tasks and the government-to-government agreements. For example, if a codevelopment program can be subdivided so that design teams can work independently, different nations (or companies) may take full responsibility for developing different portions of the system. But this can only be effective if clear interfaces can be defined between subelements, and there is mutual confidence in the design abilities of the partners. It also means that each partner will have to transfer a total design package to other partners at a later stage if coproduction is to take place. A variant of this design specialization could be that subsystem interfaces are fixed, allowing different design teams to develop interchangeable (but different) modules, thus establishing qualified dual sources for future competitions.

Most often, codevelopment programs require integrated design teams that include engineering and technical representatives from all participating nations. This increases the need to transfer personnel and to accommodate different design practices, skills, and languages.

With either separate or integrated design teams, codevelopment is the most difficult of all forms of cooperation to carry out. The benefits, however, can be substantial. Although total R&D costs may be greater because of the inefficiencies of collaboration, the cost to individual participants is less, often making codevelopment the only affordable means to acquire advanced weapons. Also, each nation acquires technology and know-how from the partners, adding to its overall defense technology base. A greater understanding of the requirements usually results, increasing the likelihood of equipment standardization, interoperability, and common logistics. Follow-on coproduction agreements can be more easily established and should be more efficient.

Nunn-Roth-Warner Amendment

Since 1986, the principal means available to DoD to encourage international codevelopment has been the Nunn-Roth-Warner Amendment to the fiscal year 1986 Defense Authorization Act, and its subsequent annual reauthorizations.

The amendment:

- authorized a specific level of DoD funding exclusively for NATO cooperative R&D projects,
- authorized expenditures of additional funds for side-by-side testing of Allied and U.S. systems and
- directed that DoD identify and consider cooperative developments or existing Allied systems as-alternatives to U.S. development programs or systems at every step of the acquisition process.²

One important provision of the Nunn Amendment required that the appropriated R&D funds be spent in the United States. The intent of this provision was to encourage Allied governments to contribute financially to cooperative programs; therefore, the U.S. money could not be obligated without a formal government-to-government agreement that would lead to a mutual commitment of funds. While European partners were required to make equitable contributions to the program, they were not required to match U.S. contributions.

The list of Nunn Programs began with an initial group of seven candidates, agreed at a February 1986 special meeting at NATO Headquarters. It has now grown to 28 programs under contract, with 8 more awaiting contract action and 11 in negotiation. Establishing a separate R&D budget line item was a powerful incentive for DoD and U.S. industry to look for opportunities for cooperation with NATO Allies.³

As with many top-down initiatives, there were some difficulties encountered when DoD began to implement the Nunn Amendment. There were, for example, no agreed guidelines on how candidate programs were to be selected by the Services and approved by the Office of the Secretary of Defense (OSD). The rules are now being established. Funds were initially divided equally among the Services and defense agencies, but now there is a single, OSD-controlled budget for which the Services must compete. How and when to negotiate with potential partners was also unclear, with each initial Nunn program handled somewhat differently. Now a rather rigorous procedure has been established for requesting authority from OSD to negotiate and to contract.

One of the main criticisms of the Nunn Amendment has been that the Services view it as a means to fund projects that do not have sufficient priority within their own

²In subsequent authorizations, Nunn amendment programs have been extended to our allies in the Western Pacific.

³Nunn amendment Cooperative R&D Funding for fiscal years: 1986-100M; 1987-\$ 145M; 1988-\$ 150M; 1989-\$ 154M; 1990-\$ 117M.

budgets, and that they will not support Nunn programs after the Nunn funding runs out (nominally after 2 years). While some Nunn programs may have been ill-advised, there are others that clearly hold high priorities, and which are now (or will be) supported fully by Service money.⁴

Several Nunn programs have encountered budget problems. For example, the Air Force dropped out of the Modular Stand-Off Weapon, and the United Kingdom has pulled out of the Advanced Sea Mine and the NATO Anti-Air Warfare System. All in all, however, there remains a much higher level of R&D cooperation now than before the Nunn Amendment was enacted for fiscal year 1986.

Program Packages

Informal schemes have also been used to encourage codevelopment by governments, including program packages and a variant called the Family of Weapons.

The program package concept brings together a variety of possible collaborative efforts, and usually several partners. A package may include coproduction as well as codevelopment. In recent years there has been considerable interest in Europe in package deals, especially because of their potential to provide a fair return (or *Juste Retour*) in terms of development and production work which in turn provides domestic income and employment. Packages have been organized around a single major program that had either a planned evolution so that participation can vary at successive stages, or has included a number of different (but related) systems, such as the Family of Weapons.

In the Family of Weapons concept, complementary mission deficiencies are identified, and one or more participating nations agree to pursue solutions to each under separate programs (e.g., one group of nations designs a long-range air-to-air missile and another group designs a short-range missile). The participating nations make tentative agreements to buy or produce the resulting systems, and refrain from duplicating the R&D. The family concept has been used repeatedly in Europe, but it has had a difficult time in the United States due in part to fears that U.S. industry will be cut out of key technology areas for a generation and the U.S. military will be stuck with second-class weapons. Central to the concept is the belief that some of the shortcomings of single-system collaboration can be overcome by collaboration that encompasses several systems in a specified functional or technological area. Only one transatlantic family continues today, the Air-to-Air Family comprised of Advanced Medium-Range Air-to-Air Missile and Advanced Short-Range Air-to-Air Missile (the latter now in trouble in Europe).

A package can also encompass different types of contributions from participating nations. An example was the 1983 U.S.-West German deal for the Patriot/Roland air defense network. The United States purchased Patriot surface-to-air missiles (designed and manufactured in the United States) and provided them to the West German Government. In return, Germany purchased Franco-German Roland units for the United States and provided operations and maintenance for both the Roland and Patriot units at U.S. bases in Germany. Germany acquired additional Roland units for its use and committed funds to other air defense efforts. The United States deferred R&D recoupment charges on the Patriot.

Direct Commercial Sales

Background

Although normally viewed as strictly a commercial operation, direct sales often result from agreements between the United States and Allied governments. Under the Arms Export Control Act, U.S. companies must obtain an export license to sell defense equipment, to provide technical assistance, or to support the training and logistics operations of foreign governments. License approval is an implied commitment by the U.S. Government to the deal, and a tacit agreement that it is in the best interests of the United States. In cases where U.S./Allied discussions have taken place and agreements reached on equipment parameters, implying that a foreign policy determination has been made favorable to the transaction, gaining approval for the necessary export licenses is usually straightforward. If, however, the commercial sale was not preceded by government-to-government deliberations, the licensing process can become extended and contentious. As Allied governments move away from dependence on FMS and toward commercial transactions, direct sales will become a more important aspect of collaboration in defense technology and weapons. The bilateral defense trade MOUs are a recognition of this trend.

Bilateral Defense Trade MOUs

Since the mid-1970s, the United States has entered into reciprocal bilateral trade Memoranda of Understanding with nearly every NATO country and others including Australia, Egypt, Israel, Pakistan, and South Korea. While varying in scope and coverage and in the degree of reciprocity required, the agreements waive buy-national preferences in procurement of defense equipment. Numerous annexes were also negotiated between the United States and individual signatory countries, augmenting the MOUs. Agreements have been reached, for example, for accepting one another's cost accounting standards, quality assurance standards, test and evaluation procedures, and selected design standards. These agreements should

⁴For example, the Multifunctional Information Distribution System and the NATO Anti-Air Warfare System.

make it easier to conduct armaments cooperation programs, including cooperative R&D.

DoD monitors activities under these bilateral MOUs and through annual meetings with signatory country officials assesses whether problems exist and, if so, what to do about them. This is the basic means to police the bilateral MOU process.

DoD Programs for Testing Foreign Weapons

Two schemes that have expanded Allied industrial sales to DoD are the Foreign Weapons Evaluation (FWE) and the NATO Comparative Test (NCT) programs. The FWE program has been underway since the early 1980s and NCT resulted from a provision of the Nunn-Roth-Warner Amendment to the fiscal year 1986 Defense Authorization Act. The intent of both programs is to test foreign-developed weapons and systems that have the potential for meeting U.S. requirements—thus eliminating the need to develop equivalent systems using DoD funds. Test candidates are proposed annually by the military departments, which solicit candidate nomination proposals from their subordinate component commands. After a preliminary screen at systems commands and a final screen at service Headquarters, candidates are forwarded to the Office of the Secretary of Defense, which reviews each proposal and selects those that are most promising.

Offsets

Commercial defense sales activities must increasingly take into account the need to provide offsets. Offsets are direct or indirect conditions of purchase of foreign defense equipment enacted by a purchaser. Offsets aim to increase economic development benefits and reduce the net balance-of-payments costs of such a purchase. Purchasers may require as **direct offsets** the purchase or production in their country of subsystems or components of the purchased system. **Indirect offsets** include the purchase of unrelated goods, services, or supplies. Most major security partners demand an offset as a condition of their purchasing a U.S.-designed system. While a complicating factor, the trends are for more rather than fewer offset demands. Since 1978, DoD's offset policy has been straightforward: offsets are the responsibility of selling companies. DoD has refrained from negotiating or guaranteeing offsets except under extraordinary circumstances, leaving it up to individual U.S. companies to negotiate agreements.

Offset demands on U.S. companies have grown enormously and meeting them is not an easy task. Special offset programs must be set up that often encompass more than a single program, making indirect offsets a major

element of U.S. companies' export strategies. Some critics argue that to meet offset commitments, U.S. prime contractors are tempted to tilt their subcontracting methods in favor of foreign subcontractors to the detriment of domestic second- and third-tier companies. Foreign-government-imposed offsets have also become more formalized, with U.S. companies forced to accept legal offset commitment, instead of the earlier "best-efforts" arrangements.⁵

NATO Methods and Procedures

Under the Conference of National Armament Directors (CNAD), NATO has some potentially powerful tools for expanding Allied armaments cooperation. The CNAD has traditionally provided for information exchange through, for example, the Service main armament groups. Additionally, procedures have been in force since 1979 which have introduced a degree of rigor and logic into the review and selection of candidate programs for NATO cooperation. Three such procedures now exist.

NATO Armaments Planning Review

The first is the NATO Armaments Planning Review (NAPR), aimed at giving greater coherence and structure to early cooperative efforts. NAPR provided for a periodic review of the equipment replacement plans of all NATO nations, in order to identify where replacement schedules for similar equipment are sufficiently close to allow nations to consider joint R&D and procurement efforts. Attention is focused on opportunities for achieving NATO standardization and interoperability and on identifying where reasonable compromises can be made in national plans. NAPR seeks to inhibit a divergence of national plans that might prevent any possibilities for cooperation. NAPR data submitted periodically by nations is also compared with priorities for achieving standardization and interoperability established by the NATO Military Authorities.

Phased Armaments Programming System

NAPR was initially developed by the Independent European Programme Group and adapted for NATO use. One of its limitations is that the national data represent a mature stage of national planning, and attempts to collaborate are much more difficult at that stage. To overcome this difficulty, NATO instituted the Phased Armaments Programming System (PAPS), which focused on reaching multinational agreements at specific milestones of the life-cycle of an acquisition program. The overall objective of PAPS is to provide a systematic framework for promoting cooperative programs based on harmonized military requirements.

⁵U.S. Office of Management and Budget, "Offsets in Defense-Related Exports: A Summary of the First Three Annual Reports," December 1987.

Conventional Armaments Planning System

The newly introduced Conventional Armaments Planning System (CAPS) focuses on defining national military requirements at the earliest possible stage (i.e., before national commitments are made) with a goal of reaching agreements on the needs and timeframes through a formal NATO process. The concept calls for a continuous dialogue in which the Alliance keeps nations informed of its requirements and the nations keep the Alliance informed about the degree to which those needs will be met. The expectation is that this top-down approach will disclose shortfalls in meeting NATO's requirements and highlight opportunities for cooperation. CAPS is intended to:

- identify priority armaments requirements;
- report and correlate national activities, plans, and programs;
- highlight instances of duplication, gaps between requirements and national activities and opportunities for cooperation; and
- measure the performance of nations, individually and collectively.

CAPS has just undergone a 2-year test and NATO has agreed in principle to implement it.

NATO Infrastructure Program

One final tool available within NATO for pursuing armaments cooperation is the NATO Infrastructure Pro-

gram. Infrastructure was initially conceived 40 years ago as a means to obtain, through common funding, the facilities necessary to support wartime operations for NATO's forces. Requirements come from proposals developed by the NATO Military Authorities and are staffed by the NATO Military Committee and reviewed by civilian bodies (i.e., the NATO Infrastructure Committee). After a rigorous process of program definition and justification, common funding is approved for procurement.

Starting in the 1960s, a significant portion of the Infrastructure Program was dedicated toward acquiring communications, command and control, and information processing systems. While the Infrastructure procurement rules are antiquated, especially for sophisticated equipment acquisition programs, NATO has succeeded in acquiring a number of complex and state-of-the-art systems. There are several advantages to this process: the programs are always closely tied to military requirements, multinational industrial teams always bid competitively, common funding is available, and significant technology and know-how are transferred among the winning contractors and to the staffs of the host nation. Some of NATO's largest and most successful cooperative programs have been funded by the NATO Infrastructure budget, for example, the NATO Air Defense Ground Environment, the NATO Integrated Communications System, and the on-going Air Command and Control System.

Appendix C

Japanese Defense Policymaking and Industry

Security Policymaking: The Players

Defense policies are formed by committee in Japan; they are not strictly the domain of one agency.¹ While the U.S. Department of Defense does not have total control over the formulation of American security and defense policies, DoD is nevertheless the lead agency in articulating the nature of, and appropriate response to perceived security threats facing the United States and its allies.

Such is not the case in Japan. The Japan Defense Agency (JDA) occupies a secondary station in the overall security bureaucracy. It is not a major cabinet position, but rather a secondary state agency. Officials on detail from the Ministries of Foreign Affairs (MOFA), Finance (MOF) and International Trade and Industry (MITI) are involved in key decisions in policy planning and procurement.

Although JDA is the lead agency in drafting defense policies, those policies are only part of a broader security policy structure for which the Ministry of Foreign Affairs takes primary responsibility. Thus, JDA struggles to keep its defense policies from being subjugated to MOFA security policies in the bureaucracy.² Policy disputes are resolved through the Security Council, consisting of the finance minister, foreign minister, chief cabinet secretary, the chairman of the National Public Safety Commission, and the directors general of the defense and economic planning agency. The prime minister chairs the Security Councils

Given the differences in interests and perceptions among various agencies and ministries, it is understandable that Japan's overall approach to security would also differ from that of the United States. What are those interests and perceptions, and their importance to the security policymaking structure?

Japan Defense Agency

Given JDA's status as a junior partner in its own domain, an important bureaucratic priority is to establish itself vis-à-vis the most powerful ministries involved in defense policy formulation. JDA's position in this process forces it to view policies in terms of how they will affect its prestige as an agency and its bargaining power relative to the bureaucracy. This is particularly true in the uniformed services which, because of Japan's historical experience, policymakers and voters treat with suspicion.

Ministry of Foreign Affairs

In the broadest context, MOFA is the most important spokesman for security policy in Japan. It defines security broadly and in international terms to include suitable defense spending levels for Japan, the nature of the Soviet threat, appropriate procurement for the Self-Defense Forces (SDF), and the role of Japanese aid programs in enhancing regional and global security.

Despite the general Japanese willingness to identify the Soviet Union as the principal security threat in Japan, Japanese officials differ on the nature of and appropriate response to that threat. For example, some MOFA officials speak of the "Soviet threat" with U.S. relations in mind. The implication is that Japan gains favor with the United States, and thus experiences less pressure in other policy areas, as a result of its support of the American perception of the Soviet threat.⁴ This demonstrates the primacy of the United States in MOFA's overall policy priorities. The 1983 exchange of notes on defense technology transfers, for example, has been interpreted as a means for the Japanese Government to strengthen ties with the United States and reduce immediate pressures on the economic front.⁵

¹This section of app. C is based partly on information drawn from the following sources: Gregg A. Rubinstein in, *Option 2000: Politics and High Technology in Japan's Defense and Strategic Future*, Ronald A. Morse (ed.) (Washington DC: Woodrow Wilson International Center for Scholars, 1987), pp. 47-60; Paul F. Langer, *Japanese National Security Policy: Domestic Determinants*, Rand Report R-1030-ISA (Santa Monica, CA: Rand Corp., 1972); John Endicott, in Committee on Foreign Affairs, *Government Decisionmaking in Japan: Implications for the United States* (Washington, DC: Government Printing Office, 1982), pp. 51-70.

²Endicott, op. cit., footnote 1.

³The Security Council was reconstituted from the National Defense Council (NDC). The NDC, unlike the current Security Council, had no authority to involve itself in crisis situations or specific actions by Japanese troops in the event of actual conflict. The Security Council was established in 1986, incorporating the NDC's authority and expanding it, largely when the limitations of Japanese Government decisionmaking were made evident in the Korean Airlines 007 incident. Although not sitting members, the Minister of International Trade and Industry and the Director General of the Science and Technology Agency also took part in NDC deliberations and have the opportunity to provide input into the Security Council at the discretion of the chair.

⁴Mike M. Mochizuki, "Japan's Search for Strategy," *International Security*, Winter 1983/84, vol. 8, No. 3, pp. 158-160. A consensus is far from evident among the writings of Japanese analysts. For a range of views, see Hisahiko Okazaki, *A Grand Strategy for Japanese Defense* (Lanham, MD: University of America Press, 1986); Masashi Nishihara, "Soviet Moves in Southeast Asia and the Southwest Pacific Today," paper presented at Japan-U.S. Joint Study on the Soviet Union, Nov. 7-8, 1987; and Richard H. Solomon and Masataka Kosaka, *The Soviet Far East Military Build-up: Nuclear Dilemmas and Asian Security* (Dover, MA: Auburn House, 1986).

⁵"What Ever Happened to Defense Technology Transfers?," *JEI Reports*, No. 30A, Aug. 7, 1987.

Ministry of International Trade and Industry

Although MITI is a commercial and industrial ministry, it is an important player in the defense and security policymaking framework. Furthermore, it is likely that MITI's role will strengthen over the coming years because of the security-economic linkage evident in Japanese policymaking and the growing importance of dual-use technologies to overall defense production. MITI exerts influence through the Security Council, its Aircraft and Ordnance Division, and through seconded officials in JDA's equipment bureau, whose director general invariably has served previously as MITI Aircraft and Ordnance Division director.⁶

Ministry of Finance

The Ministry of Finance has been a critical player in defense and security decisions throughout the postwar period, particularly with the articulation of the "minimum necessary defense" policy. The policy outlined in the early 1950s restricted defense expenditures due to the need to rebuild the domestic economy, suspicion of militaristic revivals after the war, and the protective presence of U.S. forces in Asia. A combination of economic growth and conscientious restraints on spending brought total defense expenditures from 1.78 percent of gross national product in 1954 to under 1.0 percent in 1963. Spending hovered around the 1 percent level for the following 27 years, although the 1 percent limit, formalized in a Miki cabinet decision of 1976, was dropped in 1987.⁷

While concern with a specific GNP/defense spending ratio is not a major fixation at the ministry, restraining total defense spending is still an article of faith at MOF. The broader notion of security to MOF means fiscal soundness: without a stable government and sound fiscal policy, it would be impossible to have any domestic economy at all, much less a defense establishment. Thus, further spending on defense must be defended in terms of its positive impact on the domestic economy.

Politicians

Political support for defense in Japan is mixed. There are few spokesmen for defense policy issues,⁸ and defense is not an area in which politicians can secure constituent support. This encourages politicians to focus instead on

the patronage aspects of defense policies, most evident in the income and employment generated by large procurement contracts.⁹

Domestic Industry

Domestic industries, especially the larger firms such as Mitsubishi Heavy Industries (MI-H), are looking to defense for future growth. Industry demonstrated significant influence over defense policy and procurement decisions in the FSX case, where only high-level political intervention kept the project from becoming a totally domestic effort.

Defense and Security

Japanese security policy rests squarely on economic foundations.¹⁰ The Yoshida doctrine, a broad policy approach implemented by Prime Minister Shigeru Yoshida in the immediate postwar period, emphasized economic recovery over military growth. That policy has dominated Liberal Democratic Party thinking and is widely embraced by the general public. Such a policy, however, does not mean that the government is uniformly opposed to military spending or to expanding procurement orders. One analyst notes that:

... minimally, economic security is associated in Japan with the maintenance of a stable supply of raw materials and access to foreign markets. Maximally, the concept is associated with control of production for domestic needs whenever possible.¹¹

Policymakers are inclined to support defense-related spending when it has an identifiable and positive impact on the domestic economy. It is not just the deployment of weapons that makes Japan secure, but also their strong domestic production.

Higher defense spending can also satisfy the diverse interests of other players in the security policy maker arena. For MOFA, unrestrained increases would pose a serious diplomatic problem, but measured increases both help the ministry counter charges of a free ride on defense and demonstrate that Japan is contributing more to the burden of regional defense. MITI's desire to stimulate critical industrial sectors also can be satisfied through new procurement programs, provided they do not overwhelm industrial capabilities or divert resources from other civilian sectors. Even MOF can tolerate spending in-

⁶Visions of Japan's economic future and security role are outlined in the May 1988 report *Nihon no Sentaku* (Tokyo: Tsusho Sangyo Chosakai, 1988), prepared by a special panel that included academics, corporate representatives, and think-tank members. The report is significant, among other reasons, for its frank assessment of security and economic matters.

⁷Research Institute for Peace and Security, *Asian Security 1980* (Tokyo: Nikkei Business Publishing Co., 1980), pp. 193-194; Japan Defense Agency, *Defense of Japan 2970* (Tokyo: Japan Defense Agency, 1970), p. 97; Japan Defense Agency, *Defense of Japan 1987* (Tokyo: Japan Times Co., 1987), pp. 153-155; *Yomiuri Shimbun*, U.S. edition, June 14, 1988.

⁸Takashi Inoguchi and Tomoaki Iwai, *Zokugin no Kenkyu* (Tokyo: Nihon Keizai Shimbunsha, 1987), pp. 105ff; 209-210.

⁹Ibid.

¹⁰For an examination of the interrelationship in Japan between economic and security issues, see U.S. House of Representatives, Committee on Ways and Means, "East Asia: Challenges for U.S. Economic and Security Interests in the 1990s," Committee Print 10WO, 100th Congress, 2nd sess., Sept. 26, 1988.

¹¹Raymond Ahearn, Library of Congress, Congressional Research Service, "Japan: prospects for Greater Market Openness," June 26, 1989, p. 9.

creases if they are structured to maintain the appearance of a low overall resource commitment to defense.¹² Table C-1 gives Japan's defense budgets since 1955.

Japan's Defense Industry and Market

Key Japanese corporations, most of them with links to defense production in the pre-war and World War II period, have played an important role in defense production and procurement decisions throughout the postwar period. Companies like Mitsubishi Heavy Industries, NEC, Kawasaki Heavy Industries (KHI), Toshiba, and Mitsubishi Electric Co. (MELCO) have won defense contracts worth billions of dollars for tanks, naval vessels, military aircraft, heavy artillery, radar systems, and missiles. In keeping with longstanding policy, Japanese firms now satisfy well over 80 percent of domestic weapons and military equipment needs.¹³ JDA and MITI's Aircraft and Ordnance Division emphasize domestic procurement whenever feasible, opting only when necessary for licensed production in Japan of foreign systems. JDA spends more than 80 percent of weapons funds internally, despite the potential cost advantages of direct purchases from abroad.

Other reasons for the emphasis on local production include the desire to develop new domestic markets, the need to enhance the domestic industrial technology base through infusions of military related technology and production, the desire to reduce dependence on the United States, and the hope of maximizing policy and marketing options by generating indigenous systems.

Most Japanese defense contractors are multifaceted companies, which produce mainly civilian goods. Defense production is expanding but accounts for only 0.5 percent of Japan's total industrial output,¹⁴ and defense-related sales represent small (though growing) percentages of total sales for most companies. For example, military equipment comprises only 15 percent of MHI's total sales.¹⁵

The defense market is highly oligopolistic. The top 5 contractors account for over 50 percent of total contracts and the top 10 garner 65 percent (see table C-2). MHI has been and remains by far the most important contractor, accounting for one-fourth of all defense production over the last several years and the Mitsubishi group as a whole accounts for an even higher total. The concentration of defense sales in a small group of highly integrated, prestigious, and influential firms presents opportunities

Table C-1-Japan's Initial Defense Budget, Fiscal Years 1955 through 1988

Fiscal year	Budget (billion yen)	Percent change from previous year	Budget/GNP ratio
1955	134.9	-3.3	1.78
1965	301.4	9.6	1.07
1975	1,327.3	21.4	0.84
1980	2,230.2	6.5	0.90
1981	2,400.0	7.6	0.91
1982	2,586.1	7.8	0.93
1983	2,754.2	6.5	0.98
1984	2,934.7	6.6	0.99
1985	3,137.2	6.9	0.997
1986	3,343.6	6.6	0.993
1987	3,504.0	5.2	1.04
1988	3,652.0	5.2	1.013

SOURCE: Japan Defense Agency, "Defense of Japan, 1988."

for influencing government research, development, and production decisions.

Dual-use technologies that are applied to defense from the commercial sector are becoming increasingly important in defense production strategies, as they are to the overall Japanese economy. In many respects, Japan's defense industry is more significant for its future potential than for its present capacity.

Defense sales dominate certain industrial sectors—over 80 percent of the value of Japanese aircraft production goes to the Self-Defense forces—and play an important role in electronics. Past attempts to develop commercial aircraft have been largely unsuccessful. In the 1980s the government and industry emphasized coproduction and codevelopment with foreign firms, in both military and civilian projects. In addition to collaboration on military aircraft, Japanese firms have entered into joint ventures with the Boeing Co. for the Boeing 7J7 and the V-2500 international aircraft engine consortium led by Rolls-Royce and Pratt & Whitney. Neither venture has been a commercial success,¹⁶ and the Japanese commercial aircraft industry remains small compared to U.S. and Western European counterparts.

Military production has given Japanese firms opportunities to develop airframes and avionics, with less progress in jet engines. Electronics companies in particular have participated in aircraft production to gain an additional outlet for electronics technologies used mainly in civilian products. On the other side, Japanese technology specifically developed for military aircraft, like radar systems and airframe materials, could have potential

¹²Most of Japan's procurement is financed through special government accounts that allow acquisitions on a deferred payments basis. This practice has generated tremendous obligations for future budgets, but it enables MOF and JDA to constrain any given year's budget to about 1 percent of GNP.

¹³*Boei Nenkan 1989* (Tokyo: Asagumo Shimbunsha, 1989), p. 480. License-produced systems are considered "domestic" products in these figures.

¹⁴*Ibid.*

¹⁵*Japan Company Handbook* (Tokyo: Toyo Keizai Shimposha, 1988), p. 726; *Jieitai Sobi Nenkan* (Tokyo: Asagumo Shimbunsha, 1989), pp. 524, 526.

¹⁶Richard J. Samuels and Benjamin Whipple, "Defense Production and Industrial Development: The Case of Japanese Aircraft," MIT-Japan Science and Technology program Working Paper 88-09, 1988, pp. 3-4.

Table C-2—Top Japanese Defense Contractors, Fiscal Year 1988

Company ranking	Number of contracts	Amount (billions of yen)	Percent of total
1. Mitsubishi Heavy Industries	225	364.2	26.1
2. Kawasaki Heavy Industries, Ltd.	130	150.3	10.8
3. Mitsubishi Electric Corp.	236	100.8	7.2
4. Toshiba Corp.	187	83.1	5.9
5. Ishikawajima-Harima Heavy Industries Co., Ltd.	66	77.4	5.5
6. NEC Corp.	365	73.6	5.3
7. Japan Steel Works, Ltd.	46	31.1	2.2
8. Komatsu, Ltd.	69	23.6	1.7
9. Fuji Heavy Industries, Ltd.	45	22.1	1.6
10. Fujitsu, Ltd.	203	16.8	1.2
11. Oki Electric Industry Co., Ltd.	97	16.4	1.2
12. Hitachi, Ltd.	71	16.2	1.2
13. Nissan Motor Co.,	49	15.1	1.1
14. Daikin Industries, Ltd.	66	13.2	0.9
15. Tokyo Keiki Co., Ltd.	65	11.4	0.8
16. Shimadzu Corp.	85	10.1	0.7
17. Nihon Koki, K.K.	80	9.1	0.6
18. Cosmo Oil Co., Ltd.	271	8.2	0.6
19. Kokusai Electric Co., Ltd.	169	7.9	0.6
20. Japan Radio Co., Ltd.	137	7.8	0.6
Total	2,662	1,058.3	75.7
			of all defense contracts

SOURCE: Japan Defense Agency, 1989.

applications to commercial aircraft as well as more advanced military aircraft like the FSX fighter.

In aircraft production the dominant firms are MHI, KHI and Fuji Heavy Industries, Ltd. (FHI). MHI is the prime contractor for the F-15 interceptor and KHI produces the P-3C antisubmarine surveillance aircraft, both of which are the mainstays in this sector, FHI plays the primary role in the production of the AH-1 S antitank helicopter. Japan Aircraft Manufacturing Co., Ltd. (a KHI affiliate) participates in airframe production. Ishikawajima-Harima Heavy Industries Co., Ltd. (IHI) dominates the market for jet engines, producing over 70 percent, while KHI and MHI produce the remainder. KHI also is the prime contractor for the domestically developed T-4 trainer. Care is taken to ensure equitable workshares among these firms regardless of which company acts as the prime contractor on any given project.

Five major shipbuilders supply the Maritime Self-Defense Forces: MHI, IHI; Mitsui Shipbuilding and Engineering Co., Ltd.; Hitachi Zosen Corp.; and Sumitomo Heavy Industries, Ltd. Participation in the production of the U.S. Aegis escort ship offers them new opportunities. Initially, Japanese companies will only construct the hull, while the United States will supply the electronics and weapons systems. However, as noted below, companies can be expected to try to replace imported components with domestic systems as soon as possible.

Missile production represents a growing field for Japanese producers, many of whom produce a number of missile systems for the military. Taking advantage of foreign and domestic inputs, companies have developed systems that replace foreign models and serve as the basis for related products. Representative of that strategy is the ASM-1 antiship missile, which was developed specifically to supplant the U.S.-supplied Harpoon. The Defense Agency is using the technology from this missile in the current development of the SSM-1 surface to ship missile.¹⁷

An important licensed production program is the Raytheon-MHI Patriot, a surface-to-air missile system whose first unit, a knockdown unit assembled by MHI, was delivered in 1989 to JDA. Subsequent units will be manufactured under license by MHI, with Mitsubishi Electric Corp., NEC Corp., and Toshiba Corp. playing important roles. Nissan Motors' aerospace division is another player to watch in the missile field, not only because of its role in the Patriot program (it builds the missile rocket motors for the program) but also because of its strong role in civilian booster programs and general corporate emphasis in this technology. Missile research, design, and production is proliferating into surface-to-air missiles, air-to-air missiles, antitank missiles, and even cruise missiles.¹⁸ Missiles thus represent a leading edge of Japan's effort to produce wholly domestic models of advanced weapons.

¹⁷Japan Defense Agency, *Defense of Japan 1988* (Tokyo: Japan Times Co., 1988), pp. 138-139.

¹⁸Is "Japan Uses SSM-1 Expertise to Develop Cruise Missile," *Aviation Week & Space Technology*, vol. 128, No. 12., Mar. 21, 1988, p. 59.

In the Japanese defense market, there are rarely clear-cut winners and losers in procurement competitions. Instead, firms losing out on bids as prime contractors for major programs *often end up* with a significant piece of business as subcontractors. For example, Nissan Motors' aerospace division sought the prime contract for the Patriot program in competition with MHI. Mitsubishi Electric, affiliated with MHI but in this case in competition with that company, favored improvement of the Hawk over acquisition of Patriot. Both firms received significant subcontracting roles when the Patriot business went to MHI. The earlier Hawk competition illustrates this tendency more dramatically. In that case, MELCO was locked in competition with Toshiba that was so intense it ultimately resulted in awarding prime contractor roles to both firms.

Business and Procurement Decisions

Japanese firms have encouraged the defense buildup over the past decade. Leading companies have pushed for an early realization of total domestic arms production, as evidenced by the stand of MHI in favor of the development of the FSX fighter as a purely Japanese airplane. They also have advocated lifting the ban on arms exports, although they have not pressed this in recent years because of the public's strong antimilitary views.

Defense production firms are well organized to lobby the government and cooperate in multicompany endeavors. Keidanren (the Federation of Economic Organizations, Japan's largest business association), maintains a Defense Production Committee (DPC) with a membership of over 100 manufacturing and financial firms. Virtually without exception, the DPC's chairman is also the chairman of MHI. The Japan Ordnance Association, the Society of Japanese Aerospace Companies, and the Japanese Shipbuilding Industry Association also promote the interests of their members in the defense field.¹⁹ What is notable about the membership of these associations is that many members—Sony and Honda, to name only two—are more commonly associated with commercial and consumer products, not with weapons production. Officials of these groups serve on advisory panels to the

JDA, MITI, and other government agencies. Many of these officials were former government and military officials, who maintain close ties to former colleagues.

Research and Development

JDA's Technical Research and Development Institute (TRDI) is primarily responsible for defense-related research, but its resources amount to 2.5 percent of the agency's total budget. A budget of 103.2 billion yen (\$715 million) has been proposed for fiscal year 1990, a 12.1 percent increase over fiscal year 1989.²⁰ The Institute has 1,179 employees and operates under a philosophy of relying on the private sector to the greatest extent possible to generate new technologies. Unlike the United States, where the government conducts a considerable portion of military R&D, the Japanese private sector conducts the bulk of it. The director of TRDI, Ryozo Tsutsui, stated that 81 percent of total Japanese R&D is commercially oriented, implying that the remaining 19 percent is devoted to military applications.²¹ If this split is accurate, it suggests that TRDI's annual budgets are only a small portion of total Japanese defense R&D, and that military R&D funding is underestimated.

Japanese companies manage their defense projects in conjunction with research on civilian technology, thus opening opportunities for the development of dual-use technologies. The Defense Agency often facilitates joint research programs or organizes consortia of corporations for research in specific areas.²² Some of these consortia are oriented toward research into advanced weapons systems. TRDI sometimes carries out preliminary research that it ultimately turns over to the private sector. Recent government pronouncements appear to have upgraded TRDI's role to emphasize research aimed at developing the most advanced weapons system.²³ As the director general of TRDI said: "Our view is that there is no black v. white, military v. civilian technology. All technology is just different shades of gray."²⁴

Initiating a project does not assure its success, of course. The 1988 Defense White Paper contains a list of important, independently developed weapons systems, including an antiship missile, a main battle tank, and an

¹⁹For a somewhat dated but still generally accurate examination of business-government interactions in the defense business, see D. Hopper, "Defense Policy and the Business Community: The Keidanren Defense Production Committee," J. Buck (ed.), *The Modern Japanese Military System* (Beverly Hills, CA: Sage Publishers, 1975), pp. 113-148.

²⁰Michael Green, "Japan Ups R&D Request in Bid to Boost High-Tech Base," *Defense News*, vol. 5, No. 3, Jan. 15, 1990. One significant aspect of TRDI's R&D budgets, like much of Japan's research efforts in general, is its emphasis on applied research. What is particularly important in this case, however, is that applied research translates more often into procurement contracts for industry than into basic research.

The fiscal year 1990 R&D budget targets four major projects for funding: the FSX, testing of a drone jet aircraft by the Air SDF, the Ground SDF's XATM-4 antitank missile, and the Maritime SDF's FCS-3, a fire-control system for destroyer class vessels. Funds will also be allocated for antisubmarine mines and the Tan-SAM antiaircraft missile.

²¹National Science Foundation has estimated that total Japanese R&D spending amounts to \$39.1 billion for 1987. National Science Foundation, *International Science and Technology Data Update 1988* (NSF 89-307), Washington DC, 1988, p. 4.

²²Japan Defense Agency, "SWIIMXY of 'Defense of Japan 1989,'" p. 49.

²³*Defense of Japan 1988*, op. cit., footnote 18, p.136.

²⁴"One on One: Interview with Ryozo Tsutsui, director general, Technical Research and Development Institute," *Defense News*, vol. 5, No. 8, Feb. 19, 1990, p. 38.

antisubmarine helicopter, that date back to the late 1970s; many are still not completed.²⁵ Once initiated, TRDI programs continue to be funded, indicating the government's commitment to domestic development. Indeed, JDA may sometimes delay procurement of cheaper foreign systems until indigenous counterparts are developed.

Japan has embarked on the ambitious development of a new fighter support aircraft, the FSX, to replace outdated F-1s. Although based on the General Dynamics F-16 airframe, the avionics, computer systems, and other electronic components will be supplied entirely by Japanese producers. Additional modifications will be introduced to the airframe and fuselage. U.S. companies will receive a 40 percent share of the development and production work. The costs of the development phase of the program will be well over \$1 billion, high enough that a major increase in Japan's defense budget maybe needed if other important programs are not to be neglected. The entire program is expected to cost at least \$6 billion at current exchange rates.²⁶

The role that military aircraft development will play in the future of a commercial aircraft industry remains a subject of debate, which has been heightened in the wake of the FSX controversy. But focusing on the issue of whether technology transferred in military aircraft programs can boost capabilities in the civilian aircraft industry misses the point. Japanese firms seldom seek technological infusions solely to enhance a single sector; rather, imported technology is viewed in the context of its contribution to multiple sectors and the industrial base as a whole. This is especially true for those sectors and technologies identified as key to future economic growth. Thus, to address these issues in isolation as one-to-one relationships between individual industries would underestimate Japanese ambitions and capabilities. This has implications for U.S. policy on international collaboration in defense technology because a sound policy will have to evaluate the implications of these programs beyond their traditional strategic justifications, and even in more comprehensive terms than their impact on isolated sectors of the U.S. economy,

Force Modernization and Domestic Production

JDA currently is in the fourth year of a 5-year force modernization program that calls for stepped-up procurement of front-line weapons and equipment, especially for Air and Maritime Self Defense Forces.²⁷ In addition to the

enhancements it will bring to the Japanese military and the sales opportunities it offers Japanese businesses, the plan was important for two policy reasons. First, it was the first defense buildup program to have a status as an official government plan; previous programs were simply planning estimates used to assist the JDA in preparing annual budget requests. As an official plan, the government is obligated to satisfy specific procurement objectives to the greatest degree possible with less regard to cost considerations.

Second, the enhanced status of the plan led to the elimination of the longstanding limit on total defense spending to 1 percent of the country's gross national product. Spending levels, although still hovering around 1 percent, are now determined by the procurement objectives stated explicitly in the 5-year plans. This approach is likely to remain in practice for the foreseeable future.

Major procurement and modernization goals of the current plan are:

Air defense—The Air Self-Defense Force plans to establish and modernize twelve squadrons of fighter interceptors. Eight squadrons of F-15 fighters, totaling 187 aircraft, will replace the obsolete F-104s. Approximately 100 F-4s will make up the remaining four squadrons. Japan will modernize the F-4s by adding newer surface attack equipment and sophisticated air combat electronic equipment and missiles. The Air Self-Defense Force will have 13 E-2C early warning aircraft, and the antiquated Nike-J surface-to-air missile batteries will be replaced with Patriot missiles.

Naval vessels—The destroyer/frigate force will total 62 by the end of the 1986-90 plan. Four existing destroyers and frigates will be outfitted with U.S.-designed Tartar or Sea Sparrow surface-to-air missiles. Two of the destroyers are to be equipped with the U.S. Aegis air defense system. Attack submarines are to total 16 by the end of the 1986-90 @m.

Antisubmarine aircraft—Japan will have a force of 100 P-3Cs, organized into 10 squadrons. The Maritime Self-Defense Force will have a force of nearly 90 antisubmarine helicopters by 1990.²⁸

²⁵Ibid., pp. 138-141.

²⁶Some observers have estimated vastly higher costs, as much as \$2-3 billion for development alone, with an additional \$6-8 billion for production.

²⁷The plan was introduced by the Nakasone Government for fiscal years 1986-90.

²⁸Gary K. Reynolds, Library of Congress, Congressional Research Service "Japan's Military Buildup: Goals and Accomplishments," Report No. 89-68F, 1989, pp. 5-8. This gives an assessment of the current 1986-1990 plan. The defense plans did not set specific goals for improvement of logistics, but the JDA and Prime Minister Nakasone disclosed in May 1983 that the JDA would seek a buildup of ammunition stockpiles to a level adequate for 1 month of combat (*The Daily Yomiuri*, Tokyo, May 23, 1983; Interview with Prime Minister Nakasone on the NHK television network, May 16, 1983).

Since the early 1980s, defense spending has increased by a rate of about 6 percent annually; in real terms, the increase amounted to slightly over 5 percent annually.²⁹ The defense budget reached a level of about \$31 billion annually by 1989 (at the average 1989 exchange rate). Procurement statistics indicate that Japan is roughly on schedule in authorizing the purchase of these major weapons.³⁰ These should be on-line in the Self-Defense Forces in the early 1990s.

A debate is in progress within government circles over the next 5-year plan. JDA reportedly sought the introduction of several advanced systems, including refueling tankers, over-the-horizon radar, airborne warning and command systems (AWACS), and small aircraft carriers. This last element is particularly controversial both for its force projection implications and impact on the defense industry. A senior JDA official recently declared, however, that the upcoming buildup program would not include any plans for it.

Following that declaration, there have been efforts to reduce the normal time period of the buildup program from 5 to 3 years. Bureaucrats responsible for preparing and negotiating the budget object to that proposal, insisting that the 3 full years are required to get agreement of relevant ministries to 5-year program goals. Proponents are said to be pressing for the 3-year approach to allow an earlier opportunity to reintroduce the more controversial proposals rejected for the coming plan.

Constraints on Domestic Arms Production

Since Japan's defeat in World War II, it has been wrapped in a web of constraints which help explain its current defense policy.

The first is the widespread pacifist sentiment which grew out of defeat in 1945. These sentiments are embodied in Article 9 of the 1947 Constitution, the now-famous "no-war" clause. Article 9 reads as follows:

Aspiring sincerely to an international peace based on justice and order, the Japanese people forever renounce war as a sovereign right of the nation and the threat or use of force as a means of settling international disputes.

In order to accomplish the aim of the preceding paragraph, land, sea, and air forces, as well as other war potential, will never be maintained. The right of belligerency of the state will not be recognized.

It is important to note that these two paragraphs are the only bona fide constitutional restrictions on Japan's defense. The key to present day defense policies lies in understanding the government interpretations of Article

9 in light of domestic public support and the international climate. Very few of the policies constructed on the foundation of Article 9 have been legislated since the 1954 laws establishing the Self-Defense Forces and the Japan Defense Agency were passed; rather, they result from a series of cabinet decisions over the last 30 years.

Government interpretations of Article 9 have led to further restrictions on Japan's military that have implications for its procurement decisions and defense industrial strategies. These include the prohibition of conscription (a cabinet policy based on constitutional prohibitions of involuntary servitude); restrictions on offensive weapons, a flexible policy subject to interpretation by successive governments; prohibition of participation in collective security agreements, a policy stance based on Article 9 with some legislative basis in the SDF and JDA establishment laws; and, restrictions on overseas troop deployments, a statutory restriction found in the SDF establishment law. Equally famous are Japan's non-nuclear principles—the restrictions against possessing, manufacturing, or 'introducing' nuclear weapons—issued by the Sato government in 1968. The government also vows that it will observe only peaceful uses for space. Japan's participation in the Strategic Defense Initiative is considered consistent with this policy.

A historical controversy still lingers over the origins of Article 9, but there is no doubt that pacifist sentiment in Japan is strongly embraced today, even while recognizing the potential military threat posed by the Soviet Union. A nationwide poll on security issues in July 1988 by the *Yomiuri Shimbun*, Japan's largest daily newspaper, revealed the perception that most Japanese perceived a genuine security threat along with enduring pacifism. Exactly half of the respondents in the poll, published July 12, 1988, felt that there was some or a great likelihood of Japan becoming involved in a military conflict in the near future. That concern, however, did not translate into a strong sense that Japanese must defend their country in the event of an attack. Only 3.6 percent said they would join the Self-Defense Forces in that event, with 28.3 percent declaring they would "support" the SDF. Passive resistance was endorsed by 23.0 percent and 22.7 percent declared they would "flee to a safe location." Under those circumstances, it is not surprising that over 75 percent of the respondents in a subsequent *Yomiuri* poll judged the security treaty with the United States, which obligates the United States to defend Japan in the event of an attack, as being of service to 'some extent or a great extent' to Japan.³¹

²⁹Karl D. Jackson, Deputy Assistant Secretary of Defense (East Asia and Pacific Affairs), testimony at hearings before the Subcommittee on Asian and Pacific Affairs of the House Committee on Foreign Affairs, Oct. 13, 1988.

³⁰Library of Congress, Congressional Research Service, "Japan's Military Buildup: Goals and Accomplishments," Jan. 27, 1989, pp. 5-10.

³¹"Yomiuri Shimbun Nationwide Poll: 67% Favor Current Levels for Self-Defense Forces," *Yomiuri Shimbun*, July 12, 1988, international edition, p. 8.; *Yomiuri Shimbun* Nationwide Poll on Security Treaty: Expectations on U.S. Coming to Assistance Decline," *Yomiuri Shimbun*, Aug. 1, 1988, Tokyo metropolitan evening edition, p. 6.

The second major constraint on defense policy is the **primacy of economic development over rearmament**. This is the so-called Yoshida doctrine, and it remains a fundamental tenant of Japanese economic and security policies. However, lucrative defense contracts, like those in other nations, have been justified for their economic benefits in a manner that is consistent with that doctrine.

A third point is **Japanese reliance on the United States for defense**. The U.S.-Japan mutual security treaty is a fundamental element of Japan's security policies. Japan's basic defense strategy is to possess sufficient capability to resist a limited invasion until the United States could shift its Pacific forces to support Japan.³² This strategy and the treaty that provides the rationale for its implementation remain important elements of Japan's overall security posture, particularly for Foreign Ministry officials.

During the Nixon administration, both industry and government in Japan questioned the reliability of the United States, in the context of its withdrawal from Vietnam and Southeast Asia, especially as the Soviet military buildup became more visible. Although the war in Vietnam was not popular in Japan, support by the government was viewed as the price for stable bilateral relations, freedom from economic frictions, and continued viability of the security treaty. When the United States indicated its willingness to reduce support for the South Vietnam government, the inevitable question arose in Japan of whether it would be next, encouraging thoughts of greater self-sufficiency in defense.³³

Recent official statements evidence concern regarding the ability of the United States to uphold its end of the bilateral security relationship. The 1988 defense white paper notes that "although the United States, backed by its outstanding military and economic strength, continues to play the major role in the field of international politics, no one can deny the fact that its position in the economic field is comparatively declining in recent years." Given

that there also is a strong economic component in the Japanese concept of security, it is not unreasonable to conclude that policymakers are concerned that the relative economic decline of the United States could result in a decline of the United States as a security guarantor as well.

Finally, there are differing views on the external threat. The 1976 National Defense Outline (NDO), the basic position paper governing Japan's procurement and defense strategies, was drafted under the assumption that detente would continue between the United States and the Soviet Union.³⁴ The NDO was never amended to reflect the more tense relations between Western nations (including Japan) and the U.S.S.R. during the late 1970s and early 1980s, even with the Afghanistan invasion and the KAL 007 incident. Government officials have since grown less reluctant to detail a specific Soviet threat.³⁵

Willingness to identify the Soviet Union as the principal security threat was reflected in part by an expansion of Japanese roles and missions, beginning in the late 1970s. For example, the Carter Administration formalized defense guidelines with Japan in November 1978. These called for greater coordination between U.S. and Japanese military commands, joint planning for the defense of Japan in case of external attack, stepped-up joint military exercises, and mutual logistical support.³⁶

Following visits by then-Secretary of Defense Caspar Weinberger to Japan, former Prime Minister Zenko Suzuki agreed in May 1981 to assume responsibility for defending the sea-lanes approaching Japan to a distance of 1,000 nautical miles, a zone encompassing the waters between Japan and the Philippines, swinging east from the Philippines to Guam.³⁷ U.S. and Japanese officials subsequently completed a joint sea-lane defense plan for Japanese waters in December 1986. While this plan remains classified, U.S. officials in 1981 had proposed sea control missions for Japanese naval and air forces as well as the capability to close off three critical straits around

³²One respected Foreign Ministry official, former ambassador to Saudi Arabia Hisahiko Okazaki, likens this stance to a John Wayne Western in which the cavalry rides to the rescue of settlers beleaguered by hostile Indians. For a further elaboration of Okazaki's perspective, see "The Restructuring of the U.S.-Japan Alliance," *Bungei Shunju*, July 1988.

³³For a thorough examination of Japan's ambivalent attitudes toward the Vietnam war, see Thomas R.H. Havens, *Fire Across the Sea: The Vietnam War and Japan, 1965-75* (Princeton, NJ: Princeton University Press, 1987).

³⁴The National Defense ~@ makes the following assumptions about the international situation and the necessity for self-defense program: The major power blocs will continue a dialogue toward improving relations and reducing the threat of nuclear war; despite this trend, regional instability will remain and the international situation will continue to be fluid; an equilibrium exists among the United States, China, and the Soviet Union in the area around Japan; there is little possibility of a full-scale conflict between East and West due to the military balance, including the nuclear balance; while the possibility of regional conflict cannot be dismissed, the U.S.-Japan security arrangement helps maintain international stability and prevents full-scale aggression against Japan. *Defense of Japan 1976*, pp. 3-7.

³⁵Recent white papers have made a strong case in establishing the basis of the Soviet threat and, thus, the justification of continued defense spending increases. See *Defense of Japan 1987*, pp. 35-37; *Defense of Japan 1988*, pp. 33-43; "Warning Shots Fired on Soviet Bomber," *Kyodo News Service*, Dec. 9, 1987.

³⁶U.S. Congress, Senate Committee on Armed Services, "United States-Japan Security Relationship-The Key to East Asian Security and Stability," Report of the Pacific Study Group, 96th Cong., 1st sess. (Washington DC: U.S. Government Printing office, 1979), pp. 22-27.

³⁷*Asahi Shimbun* Tokyo, Mar. 28, 1981, and *The London Times*, March 31, 1981. See also the statement by Assistant Secretary of Defense Frock West before the House Subcommittee on Asian and Pacific Affairs, Mar. 1, 1982.

the country, Tsushima, Tsugaru, and Soya, to potential aggressors.³⁸

At the Japan-U.S. Security Conference in Hawaii in June 1981, U.S. officials put forth additional force structure proposals. These called for revisions in several components of Japan's 1976 defense program. The key elements were:

- . the addition of 4 squadrons of F-15 fighters to the 10 squadrons of modernized fighters targeted in the 1976 defense program;
- . an increase in Japan's force of destroyers and frigates to 70 vessels with substantial modernization in air defense and antisubmarine capabilities;
- an increase in the number of attack submarines to 25 from Japan's target of 16;

- . the establishment of an antisubmarine aircraft force of 125 P-3Cs, the main antisubmarine aircraft of the U.S. Navy; and
- . the establishment of a 3-month supply of ammunition.

The U.S. Secretary of Defense indicated to the Japanese in March 1982 that Japan should attain this kind of force structure by 1990. He declared that such a buildup would "require substantial improvements in military capabilities and increases in defense spending substantially greater than the current annual growth rate." U.S. officials who accompanied the Secretary asserted to reporters that Japanese defense expenditures would have to increase at least 10 percent annually in real terms in order to develop these assets.³⁹

³⁸West statement, Mar. 1, 1982, *ibid.*

³⁹Richard Halloran, "U.S. Aide to Stress Japan Arms Buildup," *Newsweek*, Mar. 27, 1982, p. A-3.

South Korea: Goals and Strategy for Building Defense Industries

Introduction: Defining a Defense Industrial Strategy

South Korea plays a major role in U.S./Asian collaboration, and while its views of goals and strategies share some similarities with those of the Japanese, there also appear to be marked differences, including differences over the U.S. role over the last 25 years.

Like the Japanese, South Korean Government and industry leaders seek to increase the percentage of weapons and military equipment produced locally, but they do not appear to aim for an independent defense industry with minimal or no foreign involvement. South Korean leaders speak of a growing partnership between South Korean firms and foreign companies, especially U.S. companies, in producing weapons systems, and they have outlined three elements of this "partnership strategy."

One is to develop a significant role for Korean firms as a supplier of components and parts to major U.S. defense firms that produce in the United States, South Korean leaders stress the advantages of Korean firms supplying components and parts at reduced costs, as major U.S. defense corporations face declining U.S. defense budgets, fewer contracts, and a greater need for efficiency and cost-cutting. This would allow American firms to retain the leading edge in developing advanced technology while economizing on standard parts and components through subcontracting with Korean companies.

South Korea has instituted an offsets policy toward U.S. suppliers similar to those of Japan and Western European countries as an inducement to influence U.S. firms to subcontract for Korean-produced components and parts.

Exports are a second element of the "partnership strategy. The South Korean Government and the United States have been at odds since at least the early 1980s over South Korea's desire to export weapons and military equipment made under U.S. licenses. This pro-export policy, which contrasts with Japan's ban on arms exports, potentially could create a new source of competition to U.S.-produced weapons in world markets. The U.S. Government often has vetoed proposed South Korean sales overseas. Over some periods, more than 50 percent of applications for third country exports have been denied. Not surprisingly, U.S. defense firms generally favor such restrictions.

South Korea hopes to change U.S. policy by helping American firms gain a more competitive position in the world arms market through coproduction of weapons with South Korean industries. In their view, U.S. companies should be attracted to South Korea because of its lower production costs, which will become increasingly important as the world arms market shrinks in the 1990s (if East-West tensions decline fundamentally and regional conflicts continue to abate), and as European and Chinese arms manufacturers continue to cut into traditional U.S. markets, such as Southeast Asia, the Middle East, and Latin America. According to South Korean spokesmen, U.S. firms would control the marketing of weapons manufactured inside South Korea under coproduction deals.¹

A U.S. role in developing of Korean aerospace industry constitutes the third element of Seoul's partnership strategy. The Seoul government's Aerospace Industry Development Plan calls for South Korea to be a serious participant in the world aerospace market by the year 2000. The strategy for achieving this appears to be two-fold:

1. building up the role of South Korean companies as suppliers and parts to major aircraft manufacturers in the United States and possibly Western Europe, and
2. bringing these U.S. and European firms into collaborative arrangements for coproduction of aircraft and broader support for the Korean manufacturer of components or entire systems.

Again, South Korea seeks to attract U.S. aerospace company participation with prospects of lower production costs and thus a more competitive position in world markets.

South Korean Government and industry leaders clearly expect that the coproduction of the FX fighter plane will be a first step toward the aerospace business. The government's selection of the U.S. F-18 fighter over the F-16 had a military rationale (the South Korean Air Force reportedly favored the F-18 because of maneuverability and armaments), but the government also reportedly viewed McDonnell Douglas as better suited to assist South Korea's aerospace industry than General Dynamics, the producer of the F-16. McDonnell Douglas' sales approach to the government stressed the *company's* production of a full line of military and civilian aircraft and helicopters, the future purchase of Korean-made parts for McDonnell Douglas helicopters, and broader assis-

¹Park Young-Koon, "ROK-U.S. Defense Industry Cooperation—Past Achievements and Future Tasks," paper presented at the Fourth ROK-U.S. Defense Industry Conference, Jan. 16, 1990, p.5.

tance “designed to transfer key technologies to Korea in an efficient, building-block approach.”²

Korean industry spokesmen view the role of McDonnell Douglas as assisting South Korean participants in the FX project to design and plan future aircraft. An official of Samsung Aerospace Co., the main South Korean participant in the FX project, has stated that the U.S. partner in FX coproduction will be asked to assist Samsung in designing an “interim aircraft” which could be a light transport aircraft, a helicopter, or a sub-sonic jet trainer.³

The Samsung officials also gave a broader set of objectives in the development of an aerospace industry: reaching parity with the developed countries in the manufacture of airframes and engines by the early part of the 21st century; and reaching, sometime after that, parity in the manufacture of avionics and other specialized systems and in the development of advanced systems.⁴ He also made clear that government, industry, and the scientific community would work together towards these goals.

Motives Behind the Partnership Strategy

South Korea’s partnership strategy stems from a basic motive to maintain a viable domestic defense industry. Long-term South Korean thinking envisages a completely independent defense production capability without foreign participation. Even that, however, is tempered by the uncertainty of Korea’s security situation in the next century surrounded as it is by three big powers, China, Japan, and the Soviet Union, all of which historically have had aggressive designs on Korea. South Korea thus may well seek a long-term security link to the United States, which undoubtedly would influence defense industrial policy.

The formidable North Korean military threat and possible U.S. troop withdrawals in the future provide strong reasons to South Koreans for the development of a viable defense industry in the nearer term. A “viable domestic defense industry” apparently means one that can provide the essential needs of the South Korean armed forces, produce more advanced systems, and be economically profitable.

South Korea already has made some progress toward fulfilling domestic military requirements. By the mid-1980s South Korean industries were turning out a wide array of combat equipment. Major items were the K2 rifle, the Hyunmu surface-to-surface missile, 155mm self-propelled howitzers, destroyers, fast attack patrol boats, the 500MD helicopters, and the F-SE fighter aircraft. By

the end of the decade, the Type 88 tank was rolling off South Korean assembly lines. There presently are 100 major defense firms designated by the government and several thousand subcontractors involved in producing military equipment. Nevertheless, by 1990 domestic firms supplied only 55 percent of the arms purchased by the South Korean Government, and much of this was produced under licensing arrangements with U.S. firms. The Seoul government imported the rest, mainly from the United States. Dependence on imports is especially important in aircraft, missiles, and communications equipment.

South Korea lags far behind Western countries and Japan in defense research and development. In contrast to the situation in Japan, South Korean firms have not yet devoted large resources to military R&D and South Korean defense budgets in the 1980s have devoted only about 1.6 percent of expenditures to R&D. The Government hopes to encourage industry to engage in meaningful R&D, but for the foreseeable future, South Korea will remain dependent on foreign technology.

Creating a profitable defense industry has proven an even more difficult goal. South Korean defense firms have operated at below 60 percent of capacity for most of the period after 1984. Government procurement has not been sufficient to bring about a more efficient utilization of production capacity, a situation that will continue, especially since the emergence of a more democratic political system in 1987 has produced political pressures on the government to spend more in the civilian sectors and restrain defense budget increases.

Herein lies the pressure to export, either as suppliers of components and parts to Western defense firms or as suppliers of entire weapons systems to developing countries. The goal of exporting is key to understanding South Korea’s partnership strategy. Foreign participation will enhance the range of potential arms exports, and the involvement of American firms in coproduction would help break down U.S. opposition to the overseas sales of U.S.-designed weapons and equipment.

Preference for U.S. Participation

South Korean Government and industry leaders clearly prefer to collaborate with U.S. firms. Security is a primary consideration. The North Korean military threat is indeed formidable: North Korea possesses armed forces of over 1 million, an Army of over 800,000, 540,000 reserves that can be mobilized within 12 hours, 3,500 tanks, and over 4,000 heavy artillery pieces and rocket launchers. The bulk of North Korean ground and air forces are positioned

²Damon Darlin and Andy Pasztor, “Seoul Picks McDonnell Douglas to Build Fleet of Jet Fighters in \$3.4 Billion Deal,” *Asian Wall Street Journal Weekly*, Dec. 25, 1989, p. 19; Jeff Shear, “Congress Huffs, Puffs as Seoul Seeks to Build Fighter Planes,” *Washington Times*, Oct. 12, 1989, p. C-1.

³Kim Choe-su, “ROK-US Cooperative Programs: KFP and I-I X,” paper presented at the Fourth ROK-US Defense Industry Conference, Jan. 16, 1990, pp. 13-14.

⁴*Ibid.*, pp. 12-13.

near the demilitarized zone. South Korea's defense problems are complicated by the location of Seoul, only 30 miles south of the demarcation line.

It is not clear whether North Korea's future policy will be influenced fundamentally by the changes in Eastern Europe and the Soviet Union. Clearly, the North Korean leadership feels the impact of the changes, but its reaction has been to reject them and maintain the rigidly totalitarian system of leader Kim Il-sung. The regime apparently views the post-June 1989 political repression in China as a favorable development, countering the trends in Eastern Europe and the U.S.S.R.,

The South Korean Government, therefore, still sees a prolonged, North Korean threat, and it continues to seek an American military presence in South Korea as a counterweight and deterrent to it. Moreover, the integration of U.S. and South Korean forces on the peninsula provides a rationale among South Korean and U.S. military leaders for common weapons systems.

In addition, there are strong precedents for U.S. support of South Korea's defense industries. The U.S. Government offered over 800 technical data packages to South Korean firms from the early 1970s until 1986, and over 100 were utilized. These provided data necessary for the Korean companies to set up facilities and equipment to manufacture specific types of weapons and equipment. U.S. Foreign Military Sales credits helped to finance the establishment of production facilities.

Licensing and coproduction agreements emerged in the 1980s. Weapons produced under these arrangements include the M109 howitzer, the F-5E fighter, and the 500MD helicopter, motors, machine guns, communications equipment, and small arms. The K-88 "indigenous tank," was designed with help from General Dynamics.

Despite this preference for the United States, in the future U.S. systems will probably not be automatically selected. European defense firms have begun to bid hard for business in South Korea, and this likely will increase in the 1990s. If European firms and governments are flexible on issues like technology transfer, exports, and offsets, their attractiveness to the South Korean Government and industry could present a competitive challenge to the United States. The recently concluded deal for South Korea to acquire German submarines (which may involve coproduction) is indicative of the emerging European role in South Korea's acquisition of weapons and equipment.

The Emerging U.S. Debate

The proposed coproduction of the FX fighter has opened a debate in the U.S. over the extent to which the United States should support South Korea's defense industries.

Proponents of the FX deal, including executives of General Dynamics and McDonnell Douglas, argue that they already have fighter coproduction arrangements with a number of other countries and that U.S. firms will be able to stay well ahead of any potential *competitors in the* production of advanced fighters. They warn that South Korea may turn to European aircraft producers if the FX coproduction proposal does not materialize. Finally, they assert that the prospects of declining U.S. defense budgets make cooperative deals with foreign companies necessary for the financial health of the U.S. military aircraft industry.⁵

Critics of the deal argue that the proponents may underestimate South Korea's ability to develop an indigenous fighter by the end of the century if it is able to draw on the technology and production know-how of an advanced U.S. fighter. They also assert that even an inferior South Korean indigenous fighter could cut into U.S. markets in developing countries because of lower prices.

The proponents and critics have clashed, too, on the deeper issue of the role of the U.S. aircraft industry in the globalization of aircraft production in the 21st century. In the case of South Korea, critics accuse U.S. firms of being willing to help that country develop a full-fledged defense and aerospace industry, first by producing parts for aircraft and other weapons systems manufactured in the United States and then by producing aircraft in South Korea itself. McDonnell Douglas and General Dynamics may represent the view of other major American defense companies when they assert that U.S. companies must be involved in the globalization of aircraft production. They cite profits to be gained from such assistance to countries like South Korea (in contrast to a likely shrinking U.S. market) and cost benefits in shifting the production of components overseas.

In the aftermath of the bitter dispute over the Japanese FSX fighter, the emerging debate over the South Korean FX fighter may clarify the differing views of U.S. defense companies and opponents of such deals: the former argue for global interdependence and the ability of U.S. firms to prosper in that environment, and the latter argue that interdependence will cause American companies to lose their competitive advantage, and that self-sufficiency will ensure a continuation of American supremacy.

⁵Jeff Shear, *op. cit.*, footnote 2.