

*The Future of Remote Sensing From Space:  
Civilian Satellite Systems and Applications*

July 1993

OTA-ISC-558

NTIS order #PB93-231322

GPO stock #052-003-01333-9

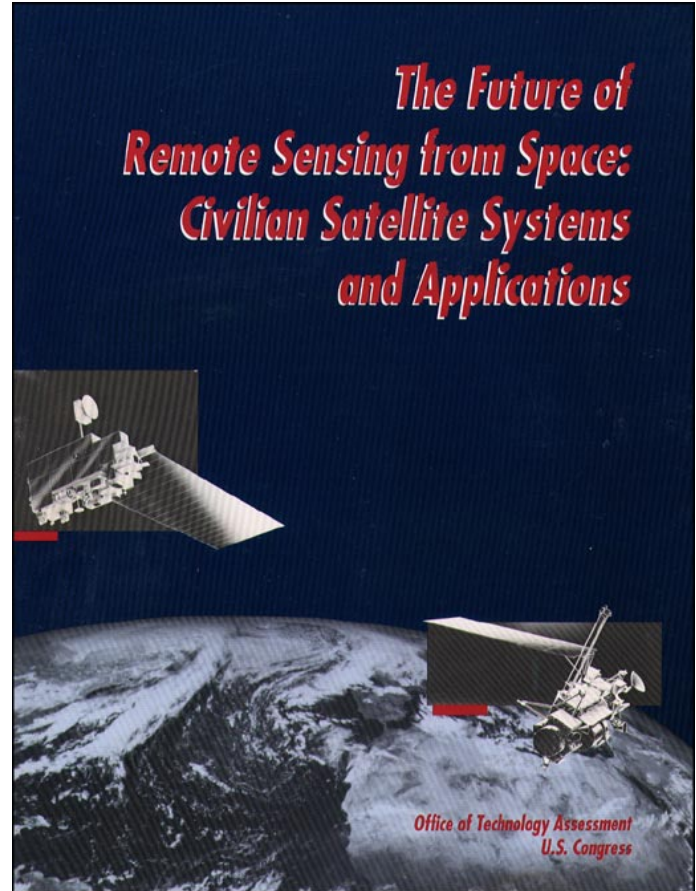

Recommended Citation:

U.S. Congress, Office of Technology Assessment, *The Future of Remote Sensing From Space: Civilian Satellite Systems and Applications*, OTA-ISC-558 (Washington, DC: U.S. Government Printing Office, July 1993).

---

For sale by the U.S. Government Printing Office  
Superintendent of Documents, Mail Stop: SSOP, Washington, DC 20402-9328

ISBN 0-16-041884-4

# Foreword

Over the past decade, the United States and other countries have increasingly turned to satellite remote sensing to gather data about the state of Earth's atmosphere, land, and oceans. Satellite systems provide the vantage point and coverage necessary to study our planet as an integrated, interactive physical and biological system. In particular, the data they provide, combined with data from surface and aircraft-based instruments, should help scientists monitor, understand, and ultimately predict the long term effects of global change.

This report, the first of three in a broad OTA assessment of Earth observation systems, examines issues related to the development and operation of publicly funded U.S. and foreign civilian remote sensing systems. It also explores the military and intelligence use of data gathered by civilian satellites. In addition, the report examines the outlook for privately funded and operated remote sensing systems.

Despite the established utility of remote sensing technology in a wide variety of applications, the state of the U.S. economy and the burden of an increasing Federal deficit will force NASA, NOAA, and DoD to seek ways to reduce the costs of remote sensing systems. This report observes that maximizing the return on the U.S. investment in satellite remote sensing will require the Federal Government to develop a flexible, long-term interagency plan that would guarantee the routine collection of high-quality measurements of the atmosphere, oceans, and land over decades. Such a plan would assign the part each agency plays in gathering data on global change, including scientifically critical observations from aircraft- and ground-based platforms, as well as from space-based platforms. It would also develop appropriate mechanisms for archiving, integrating, and distributing data from many different sources for research and other purposes. Finally, it would assign to the private sector increasing responsibility for collecting and archiving remotely sensed data.

In undertaking this effort, OTA sought the contributions of a wide spectrum of knowledgeable individuals and organizations. Some provided information; others reviewed drafts. OTA gratefully acknowledges their contributions of time and intellectual effort. OTA also appreciates the help and cooperation of officials with NASA, NOAA, DOE, and DoD. As with all OTA reports, the content of this report is the sole responsibility of the Office of Technology Assessment and does not necessarily represent the views of our advisors or reviewers.



Roger C. Herdman, Director

# Advisory Panel

Rodney Nichols  
*Chair*  
Chief Executive Officer  
New York Academy of Sciences

James G. Anderson  
Professor  
Department of Chemistry and Earth  
and Planetary Sciences  
Harvard University

D. James Baker<sup>1</sup>  
Director  
Joint Oceanographic Institutions, Inc.

William Brown  
President  
ERIM Corp.

Ronald Brunner  
Professor  
Center for Public Policy Research  
University of Colorado

Joanne Gabrynowicz  
Associate Professor  
Department of Space Studies  
University of North Dakota

Alexander F.H. Goetz  
Director  
Center for the Study of Earth from  
Space  
University of Colorado

David Goodenough  
Chief Research Scientist  
Pacific Forestry Center  
Canada

Donald Latham  
Corporate Director  
Loral Corp.

Cecil E. Leith  
Physicist  
Lawrence Livermore National  
Laboratory

John H. McElroy  
Dean of Engineering  
The University of Texas at  
Arlington

Molly Macauley  
Fellow  
Resources for the Future

Earl Merritt  
Vice President, Research  
Earthsat Corp.

Alan Miller  
Director  
The Center for Global Change  
University of Maryland

Raymond E. Miller  
Professor  
Department of Computer Science  
University of Maryland

Kenneth Pedersen  
Research Professor of International  
Affairs  
School of Foreign Service  
Georgetown University

David T. Sandwell  
Geological Resources Division  
Scripps Institute of Oceanography

Dorm Walklet  
President  
TerraNOVA International

Albert Wheelon  
Consultant

<sup>1</sup> Until May 1993,

*NOTE: OTA appreciates and is grateful for the valuable assistance and thoughtful critiques provided by the advisory panel members. The Panel does not, however, necessarily approve, disapprove, or endorse this report. OTA assumes full responsibility for the report and the accuracy of its contents.*

# Project Staff

Peter Blair  
Assistant Director, OTA Energy,  
Materials, and International  
Security Division

Alan Shaw  
International Security and  
Commerce Program Manager

Ray A. Williamson  
Project Director

Arthur Charo

Brian McCue

Stephen Wooley

## CONTRACTORS

Paul Bowersox

Leonard David

Ronald M. Konkell

## ADMINISTRATIVE STAFF

Jacqueline R. Boykin  
Office Administrator

Louise Staley  
Administrative Secretary

Madeline Gross  
Contractor

# Workshop Participants

## THE FUTURE OF REMOTE SENSING FROM SPACE WORKSHOP, APRIL 21, 1992

Ray A. Williamson  
*Chair*  
Office of Technology  
Assessment

Bruce Barkstrom  
ERBE Experiment Scientist  
NASA—Langley Research  
Center

Francis P. Bretherton  
Director  
Space Science and Engineering  
Center  
University of Wisconsin

Donald Cobb  
Division Group Leader  
Space Science and Technology  
Los Alamos National Laboratory

Lee Demitry  
Program Manager  
Advanced Research Project  
Agency

Jeffrey Dozier  
Professor  
Center for Remote Sensing and  
Advanced Optics  
University of California at Santa  
Barbara

Diane Evans  
Manager for Earth Sciences  
Programs  
Jet Propulsion Laboratory

James Hansen  
Director  
NASA-Goddard Institute for  
Space Studies

John S. Langford  
President  
Aurora Flight Sciences Corp.

Keith Lyon  
SeaStar Program Manager  
Orbital Sciences Corp.

Earl Merritt  
Vice President, Research  
Earthsat Corp.

Ari Patrinos  
Director, Environmental  
Sciences Division  
U.S. Department of Energy

John C. Petheram  
Manager, Space Systems programs  
GE Astro-Space Division

Stanley R. Schneider  
Landsat Program Manager  
NASA Headquarters

Carl Schueler  
Manager  
Advanced Development Programs  
Hughes Santa Barbara Research  
Center

John Vitko, Jr.  
Manager Global Climate Change  
Sandia National Laboratories

Matthew R. Willard  
Consultant

## POTENTIAL MILITARY USES OF CIVILIAN SATELLITES WORKSHOP, JULY 8,1992

Ray A. Williamson  
*Chair*  
Office of Technology  
Assessment

James R. Blackwell  
Director  
International Security Division  
Meridian Corp.

Kenneth Daugherty  
Chief Scientist  
Defense Mapping Agency

John Hudson  
Systems Officer  
Defense Intelligence Agency

William Kennedy  
Hughes STX

Michael Krepon  
President  
Henry L. Stimson Center

Donald Latham  
Corporate Director  
Loral Corp.

John G. Thunen  
Manager, Special Projects  
Hughes-Santa Barbara Research  
Center

Peter Zimmerman  
Senior Fellow  
Center for Strategic and  
International Studies

# Acknowledgments

This report has benefited from the advice of many individuals. In addition to members of the Advisory Panel and the workshop, OTA especially would like to thank the following individuals for their assistance and support. The views expressed in this paper, however, are the sole responsibility of the Office of Technology Assessment.

Stephen W. Altes  
Aurora Flight Sciences Corp.

Donald Artis  
U.S. Army Topographic  
Engineering Center

Arthur Booth  
National Oceanic and Atmospheric  
Administration

Andrew Boyle  
Sandia National Laboratories

Dino Brugioni  
Fredericksburg, VA

Dixon Butler  
National Aeronautics and Space  
Administration

Barbara Cherry  
National Aeronautics and Space  
Administration

Thomas Cremins  
National Aeronautics and Space  
Administration

William Crocker  
U.S. General Accounting Office

Brian D. Dailey  
Lockheed Missiles & Space Co.,  
Inc.

John Dutton  
Pennsylvania State University

H. Frank Eden  
Martin Marietta Astro Space

Richard Eiserman  
U.S. General Accounting Office

Charles Elachi  
Jet Propulsion Laboratory

Bernard P. Elero  
Martin Marietta Astro Space

Douglas B. Gerull  
WorldView Imaging Corp.

Louis Gomberg  
Hughes Space and Communications  
Group

Ken Hadeen  
NOAA National Climatic Data  
Center

Michael Hall  
National Oceanic and Atmospheric  
Administration

Stephen Harper  
EOSAT Corp.

Fred Henderson  
Geosat Committee Inc.

W. John Hussey  
National Oceanic and Atmospheric  
Administration

Bhupendra Jasani  
King's College

MaJ. Frank Kelly, USAF  
Department of Defense

Mary Dee Kerwin  
National Aeronautics and Space  
Administration

Jack Koeppen  
National Oceanic and Atmospheric  
Administration

Russell Koffler  
Fort Washington, MD

John S. Langford  
Aurora Flight Sciences Corp.

Donald Light  
U.S. Geological Survey

Keith Lyon  
orbital Sciences Corp.

John MacDonald  
MacDonald Dettwiler



Jeffrey Marquese  
Institute for Defense Analyses

Thomas Meyer  
Los Alamos National Laboratory

Aram Mika  
Hughes Santa Barbara Research  
Center

David Moore  
Congressional Budget Office

Stanley Morain  
Technology Application Center  
University of New Mexico

Richard Mroczynski  
EOSAT Corp.

Firouz Michael Naderi  
Jet Propulsion Laboratory

Douglas Namian  
National Oceanic and Atmospheric  
Administration

Pat Nash  
National Aeronautics and Space  
Administration

Ted G. Nanz  
SPOT Image Corp.

Clark Nelson  
SPOT Image Corp.

Scott Pace  
The Rand Corp.

Carl Reber  
NASA Goddard Space Flight  
Center

Sally Ride  
California Space Institute  
University of California,  
San Diego

Thomas Sever  
John C. Stennis Space Center

Lisa Shaffer  
National Aeronautics and Space  
Administration

Kathryn Sullivan  
National Oceanic and Atmospheric  
Administration

Shelby Tilford  
National Aeronautics and Space  
Administration

Milton C. Trichel  
ERIM

Paul F. Uhler  
National Academy of Sciences

Pat Viets  
National Oceanic and Atmospheric  
Administration

Wulf Von Kries  
MST Aerospace GmbH

Allen H. Watkins  
U.S. Geological Survey

Daniel Woods  
National Aeronautics and Space  
Administration

Makoto Yokota  
**MITI**

# Plate Descriptions

## PLATE 1. Eye of Hurricane Andrew Approaching the Louisiana Coast

This image of Hurricane Andrew was taken Aug. 26, 1992, just as the eye of the storm was moving ashore. The NOAA GOES-7 image shows bands of intense rain and the spiral “arms” of the storm.

**SOURCE: NOAA NESDIS. Used with permission.**

## PLATE 2. Late Start of the 1993 Growing Season in the United States

The vegetation index, an indicator derived using data from the Advanced Very High Resolution Radiometer (AVHRR) flown on the NOAA polar-orbiting operational environmental satellites, was used to detect the beginning and progress of the 1993 growing season in the United States. The accompanying image compares values of the Normalized Difference Vegetation Index (NDVI) for mid-May in 6 consecutive years, 1988-1993.

This image shows that the development of vegetation in mid-May 1993 is below the other 5 years. In the southeastern United States and California the area with well-developed vegetation in 1993 (NDVI between 0.1 and 0.3, yellow and light green colors) is much smaller than for any other of the 5 years. Also, very few areas show well-developed vegetation (NDVI above 0.3, dark green color) in May 1993. In the rest of the United States the area with low NDVI values (between 0.005 and 0.1, red and brown colors) in 1993 is much larger than in the other 5 years. Interestingly, a much larger area with underdeveloped vegetation (NDVI below 0.05, gray color) is observed this year compared with 1988-1992.

Similar images from April show that late development of vegetation in 1993 has been observed since the beginning of the usual growing season. The current vegetation state is approximately 3 to 5 weeks behind the 1988-92 average for the entire United States. The exceptions are southern Florida, California, and Texas, where end-of-April vegetation development was normal or ahead of normal. By mid-May nearly 35 percent of the U.S. area was more than 4 weeks behind.

**SOURCE: NOAA/NESDIS, Satellite Research Laboratory. Used with permission.**

## PLATE 3. Vegetation Index

NOAA satellites monitor the greenness in vegetation. This Vegetation Index image shows abundant (dark green) vegetation across the Amazon of South America, while lack of vegetation (black areas) is seen across the Sahara Desert in northern Africa.

**SOURCE: NOAA/NESDIS. Used with permission.**

## PLATE 4. Landsat Image of the Olympic Peninsula, Washington

The Earth Observation Satellite Co. (EOSAT) generated this image from data acquired on July 21, 1988, from the LandSat 5 satellite (Thematic Mapper bands 4,5,1 (RGB)). The permanent snowcap appears lavender; dark red distinguishes old forest growth from new (light red and cyan). Seattle’s metropolitan area appears east of Puget Sound.

**SOURCE: Photograph courtesy of EOSAT. Used with permission.**

## PLATE 5. Sea-Surface Temperature

NOAA satellites provides a detailed view of sea surface temperatures for use by the shipping and fishing industry. The dark red indicates the Gulf Stream while the green and blue shades indicate the cooler coastal waters.

**SOURCE: NOAA/NESDIS. Used with permission.**

## PLATE 6. Tidal Effects in Morecambe Bay

This multitemporal image from the ERS-1 satellite’s synthetic aperture radar shows Morecambe Bay (just north of Blackpool, UK). Highlighted in magenta are the vast expanses of sandbanks and mud flats within the Bay that are covered by the sea at high tide (Aug. 7, 1992) and exposed at low tide (Aug. 1 and 13). The patterns within these areas reflect the various rises, dips and drainage channels that cross the sand and mud at low tide. The tidal effect can be observed to extend several kilometers inland up the numerous river courses.

**SOURCE: European Space Agency. Used with permission.**

## PLATE 7. Deforestation in Brazil

This false-color, ERS-1 synthetic aperture radar image shows the Teles Pires river in Brazil (Mato Grosso State) and tropical rain forests that have been partially cut down. A regular pattern of deforestation is clearly visible, with some rectangular patches of destroyed forest extending over areas as large as 20 square kilometers. Since tropical forests are often obscured by clouds, the radar on ERS-1 is well-suited to imaging areas near the equator.

**SOURCE: European Space Agency. Used with permission.**

## PLATE 8. Changes in the Central Pacific Ocean

This series of three panels shows monthly sea level changes in the central Pacific Ocean as observed by the TOPEX/Poseidon satellite from November 1992 to January 1993. The area shown in red is the region where sea level is more than 15 centimeters (6 inches) greater than normal. In the series of panels, the eastward movement of an area of high sea level is clearly visible. Such movement represents the release of vast amounts of heat energy stored in a so-called "Warm Pool" region of the western equatorial Pacific. When it impinges on the coast of South America, such a current may become known as an El Niño event; past El Niño events have resulted in devastation of Peruvian fisheries, increased rainfall amounts across the southern United States and world-wide disturbances in weather patterns that have caused severe economic losses. These images were produced from TOPEX/Poseidon *altimetry data* by the Ocean Monitoring and Prediction Systems Section of the U.S. Naval Research Laboratory. TOPEX/Poseidon is a joint project of NASA and the French space agency, Centre National d'Etudes Spatiales (CNES).

**SOURCE: Public Information Office, Jet Propulsion Laboratory, California Institute of Technology, National Aeronautics and Space Administration, Pasadena, California. Used with permission.**

## PLATE 9. Ozone Depletion

Data from NOAA's Polar-Orbiting TOVS (Tiros Operational Vertical Sounder) is used to display the rapid decline in protective stratospheric ozone over Antarctica during the past dozen years. The growing black spot represents the lowest total ozone values,

**SOURCE: NOAA, NESDIS. Used with permission.**

## PLATE 10. Kharg Island

By tinting the 1986 image of Kharg Island, Iran one color, and the 1987 image another, and then combining the images, analysts were able to highlight changes on the island. Objects present in the first image but not in the second appear in blue, while objects present in the second image but not in the first, such as the circular anti-aircraft battery on the small island to the North appear yellow.

**SOURCE: 1993 CNES, Provided by SPOT Image Corp., Reston, VA. Reprinted with permission.**

## PLATES 11 and 12, Civilian Satellites and Verification

In the first image, the Vetrino missile operating base in 1988 is shown. Overlay of the site diagram from the INF treaty shows a reasonably good fit with observed and treaty data. Nevertheless, some *differences* can be identified; for example, at *A* the road turns in a different direction, at *B* some new construction has taken place by 1988, and at *C*, the structure is not indicated in the treaty.

The second image shows an enlarged section from an image of the Polotsk missile operating base. Overlay of the site diagram from the INF treaty is not a good fit in this case. For example, the orientation of a building at *A* is different in the image from that indicated in the treaty; the road at *B* cannot be seen in the image and the perimeter fence (*C*) is very different. Also, considerable difference exists between the structure at *D* and the road leading in or out of the facility.

**SOURCE: Bhupendra Jasani, CNES/SPOT; images processed at RAE, Farnborough, UK. Reprinted with permission.**

# Contents

## 1 Introduction 1

- What is Remote Sensing from Space? 5
- Remote Sensing Applications 6

## 2 Remote Sensing and the U.S. Future in Space 11

- The Changing Context of Satellite Remote Sensing* 11
- NOAA's Environmental Earth Observations 14
- Defense Meteorological Satellite Program 15
- NASA's Mission to Planet Earth 16
- NASA's Remote Sensing Budget 18
- NOAA's Remote Sensing Budget 23
- The Costs and Benefits of Satellite Remote Sensing 24
- Data Continuity, Long-Term Research, and Resource Management 25
- Developing and Executing a Strategic Plan for Space-Based Remote Sensing 26

## 3 Weather and Climate Observations 33

- NOAA's Operational Environmental Satellite Programs 34
- Defense Meteorological Satellite Program 43
- Non-U.S. Environmental Satellite Systems 44

## 4 Surface Remote Sensing 47

- The Landsat Program 48
- Non-U.S. Land Remote Sensing Systems 52
- Ocean Sensing and the Ice Caps 54
- Major Existing or Planned Ocean and Ice Remote Sensing Satellites 57

## 5 Global Change Research 63

- The U.S. Global Change Research Program 63
- NASA's Mission to Planet Earth 65
- Structuring a Robust, Responsive, Global Change Research Program 72

## 6 Military Uses of Civilian Remotely Sensed Data 81

## 7 The Role of the Private Sector 85

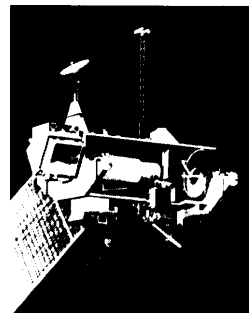

## **8 International Cooperation and Competition 89**

Increased International Cooperation in Earth Monitoring  
and Global Change Research 89

International Cooperation and Surface Remote Sensing 91

Maintaining a U.S. Competitive Position in Remote Sensing 92

## **APPENDIXES**

### **A Research and the Earth Observing System 95**

### **B The Future of Earth Remote Sensing Technologies 109**

### **C Military Uses of Civilian Remote Sensing Data 145**

### **D Non-U.S. Earth Observation Satellite Programs 167**

### **E Glossary of Acronyms 189**

## **INDEX 193**

# Introduction

# 1

Since the first civilian remote sensing satellite was launched in 1960, the United States has come increasingly to rely on space-based remote sensing to serve a wide variety of needs for data about the atmosphere, land, and oceans (table 1-1). Other nations have followed the U.S. lead. The vantage point of space offers a broadscale view of Earth, with repetitive coverage unaffected by political boundaries. Recent advances in sensors, telecommunications, and computers have made possible the development and operation of advanced satellite systems (figure 1-1) that deliver vital information about our planet to Earth-bound users.

Many Federal agencies, including the Department of Defense (DoD), use remotely sensed data to carry out their legislatively mandated programs to protect and assist U.S. citizens and to reserve and manage U.S. resources. For making routine observations of weather and climate, the National Oceanic and Atmospheric Administration (NOAA) operates two environmental satellite systems. DoD also operates a system of environmental satellites.<sup>1</sup>The scientific satellites and instruments of the National Aeronautics and Space Administration (NASA) probe Earth's environment for scientific research. Future NASA scientific satellites will include NASA's Earth Observing System (EOS), a series of sophisticated, low-orbit satellites to gather global environmental data and assist in assessing global environmental change. DoD and NASA now jointly manage the Landsat program, which provides highly useful images of the land and coastal waters.

<sup>1</sup>This report is not concerned with any satellite system built exclusively for national security purposes, except for the Defense Meteorological Satellite Program. Data from DMSP are made available to civilian users through NOAA.

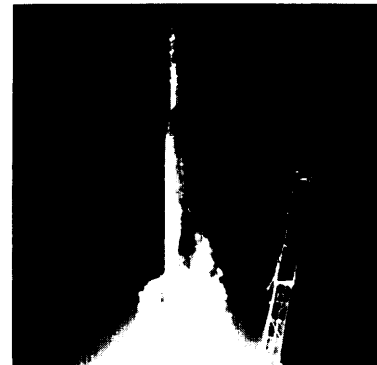

## 2 | Remote Sensing From Space

Table I-I--Current U.S. Civilian Satellite Remote Sensing Systems<sup>a</sup>

System	Operator	Mission	Status
Geostationary Operational Environmental Satellite (GOES)	NOAA	Weather monitoring, severe storm warning, and environmental data relay	1 operational; 1994 launch of GOES-1 (GOES-Next)
Polar-orbiting Operational Environmental Satellite (POES)	NOAA	Weather/climate; land, ocean observations; emergency rescue	2 partially operational; 2 fully operational; launch as needed
Defense Meteorological Satellite Program (DMSP)	DoD	Weather/climate observations	1 partially operational; 2 fully operational; launch as needed
Landsat	DoD/NASA EOSAT <sup>b</sup>	Mapping, charting, geodesy; global change, environmental monitoring	Landsat 4&5 operational, 1993 launch for Landsat 6
Upper Atmosphere Research Satellite (UARS)	NASA	Upper atmosphere chemistry, winds, energy inputs	In operation; launched in 1991
Laser Geodynamics Satellite (LAGEOS)	NASA/Italy	Earth's gravity field, continental drift	One in orbit; another launched in 1992
TOPEX/Poseidon	NASA/CNES (France)	Ocean topography	In operation; launched in 1992

<sup>a</sup> The United States also collects and archives Earth data from non-us. satellites.

<sup>b</sup> EOSAT, a private corporation, operates Landsats 4, 5, and 6. DoD and NASA will operate a future LandSat 7.

SOURCE: Office of Technology Assessment, 1993.

This report is the first major publication of an assessment of Earth observation systems requested by the House Committee on Science, Space, and Technology; the Senate Committee on Commerce, Science, and Transportation; the House and Senate Appropriations Subcommittees on Veterans Affairs, Housing and Urban Development, and Independent Agencies; and the House Permanent Select Committee on Intelligence.

This report examines the future of civilian remote sensing satellites and systems. In particular, it provides a guide to the sensors and systems operating today and those planned for the future. The report also explores issues of innovation in remote sensing technology and briefly examines the many applications of remotely sensed data. In addition, the report examines the use of civilian data for military purposes, although it does not investigate the potential civilian use of classified

remotely sensed data acquired for national security purposes.<sup>2</sup>

**The United States is entering a new era, in which it is planning to spend an increasing proportion of its civilian space budget on the development and use of remote sensing technologies to support environmental study. Building and operating remote sensing systems for U.S. Government needs could cost more than \$30 billion<sup>3</sup> over the next two decades. The extent of future public investment in space-based remote sensing will depend in part on how well these systems serve the public interest. Remote sensing activities already touch many aspects of our lives. The future of space-based remote sensing raises questions for Congress related to:**

- . U.S. commitment to global change research and monitoring, which requires long-term funding and continuity of data acquisition;

<sup>2</sup> A committee of scientists organized by Vice President Albert Gore in his former role as chairman of the Senate Subcommittee on Science, Technology, and Space, is examining the potential for such data to assist in global-change research.

<sup>3</sup> In 1992 dollars.

Figure I-1—Existing Earth Monitoring Satellites

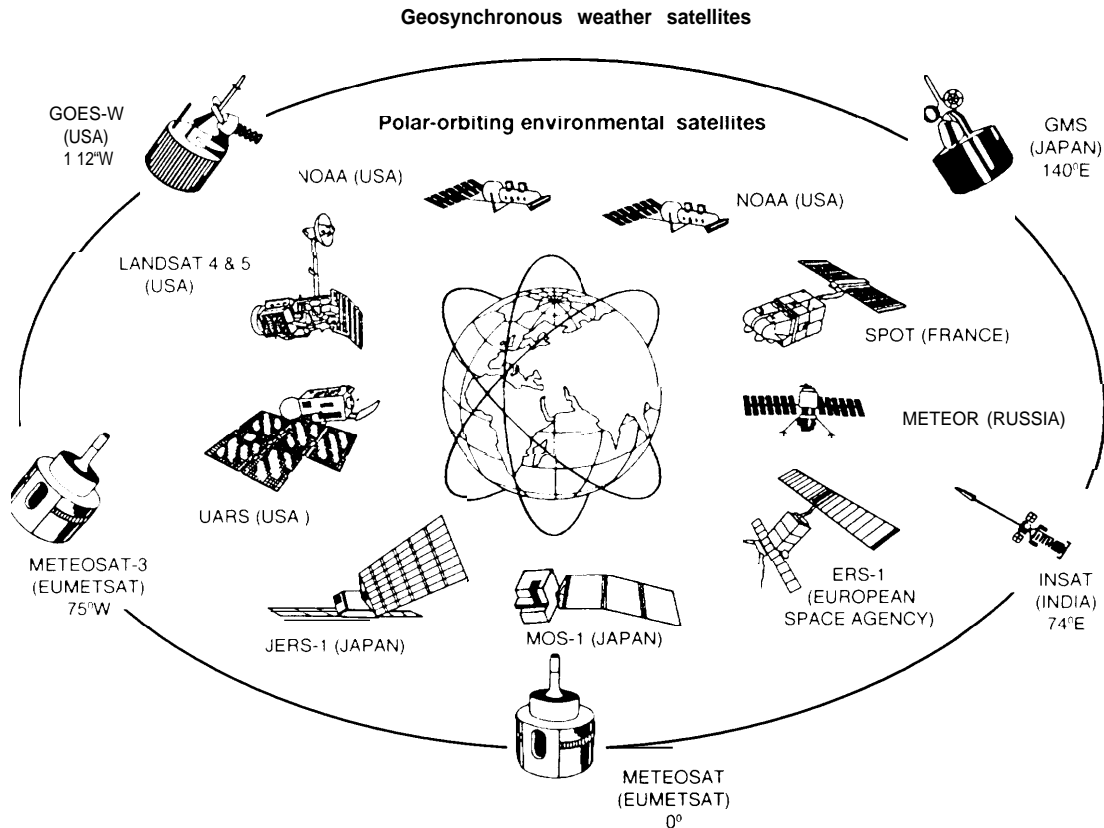

Several countries operate satellites to monitor Earth and gather environmental data. This figure depicts most of those satellites that are in either geosynchronous or polar/near-polar orbits.

SOURCE: Office of Technology Assessment, 1993.

- . the role of U.S. industry as partners in supplying sensors, satellites, ground systems, and advanced data products;
- . America's competitive position in advanced technology; and
- U.S. interest in using international cooperative mechanisms to further U.S. economic, foreign policy, and scientific goals.

These items of public policy intersect with questions concerning the overall structure and focus of the U.S. space program, and the scale of public spending on space activities. Thus, Congress will have to decide:

- The total spending for space, as well as the allocations for major programs such as Earth science from space, space science, space shuttle, and the space station;
- The role of remote sensing in the space program;
- The role of satellite remote sensing in U.S. global change research; and
- Congress' role in assisting U.S. industry to maintain U.S. competitiveness in satellite remote sensing and related industries.

Existing and planned satellite systems raise issues of utility, cost effectiveness, and technology readiness. The United States pioneered the



## 4 I Remote Sensing From Space

### Box I-A-Report Appendixes

*Appendix A: Global Change Research From Satellites* outlines the U.S. Global Change Research Program and examines the use of space-based remote sensing for assessing the long-term effects of global change. In particular, it examines the roles played by NASA's Earth Observing System, NOM's environmental satellites, and foreign systems.

This report examines the issues raised by the development of new remote sensing technologies in Appendix B: *The Future of Remote Sensing Technologies*. In particular, the appendix summarizes the state-of-the-art in technology development and explores the issues raised by innovation in sensor and spacecraft design. It also summarizes the characteristics of planned instruments that were deferred during the 1991 and 1992 restructuring of EOS.

The Gulf War provided a clear lesson in the utility of data from civilian systems for certain military uses. More the war, no accurate, high quality maps of Kuwait and the Gulf area existed. Hence, U.S. military planners had to depend in part on maps generated from remotely sensed images acquired from Landsat and the French SPOT satellite for planning and executing allied maneuvers. Appendix C: *Military Uses of Civilian Sensing Satellites* explores the technical and policy issues regarding the military use of data from civilian systems.

Appendix D: *International Remote Sensing Efforts* summarizes non-U.S. satellite systems and some of the international cooperative programs.

SOURCE: Office of Technology Assessment, 1993.

use of space-based remote sensing in the 1960s and 1970s; today the governments of several other countries and the European Space Agency (ESA) also operate highly sophisticated environmental remote sensing systems for a variety of applications (figure I-1). For the future, other nations are planning additional remote sensing satellites that will both complement, and compete with, U.S. systems. These circumstances present a formidable challenge to the United States.

Satellite remote sensing is a major source of **data** for global change research as well as weather forecasting and other applications. Data from these systems must be integrated with a wide variety of data gathered by sensors on aircraft, land, and ocean-based facilities to generate useful information. This report explores how satellite remote sensing fits in with these other systems. It also addresses U.S. policy toward the remote sensing industry. Detailed discussion of many of this report's findings may be found in the appendixes (box I-A).

By the early 21st century, U.S. and foreign remote sensing systems will generate prodigious amounts of data in a variety of formats. Using these data will require adequate storage and the ability to manage, organize, sort, distribute, and manipulate data at unprecedented speeds. NASA, NOAA, and DoD are responsible for developing and operating the data gathering systems, yet other government agencies and many private sector entities will also use the data for a variety of ongoing research and applications programs. A future report in this assessment, expected for release in late 1993, will examine issues connected with data analysis, organization, and distribution.

The distribution and sales of data from Landsat and other land remote sensing systems raise issues of public versus private goods, appropriate price of data, and relations with foreign data customers. These issues are discussed in a background paper, *Remotely Sensed Data From Space:*

Figure 1-2—Spacebased Sensors View Earth

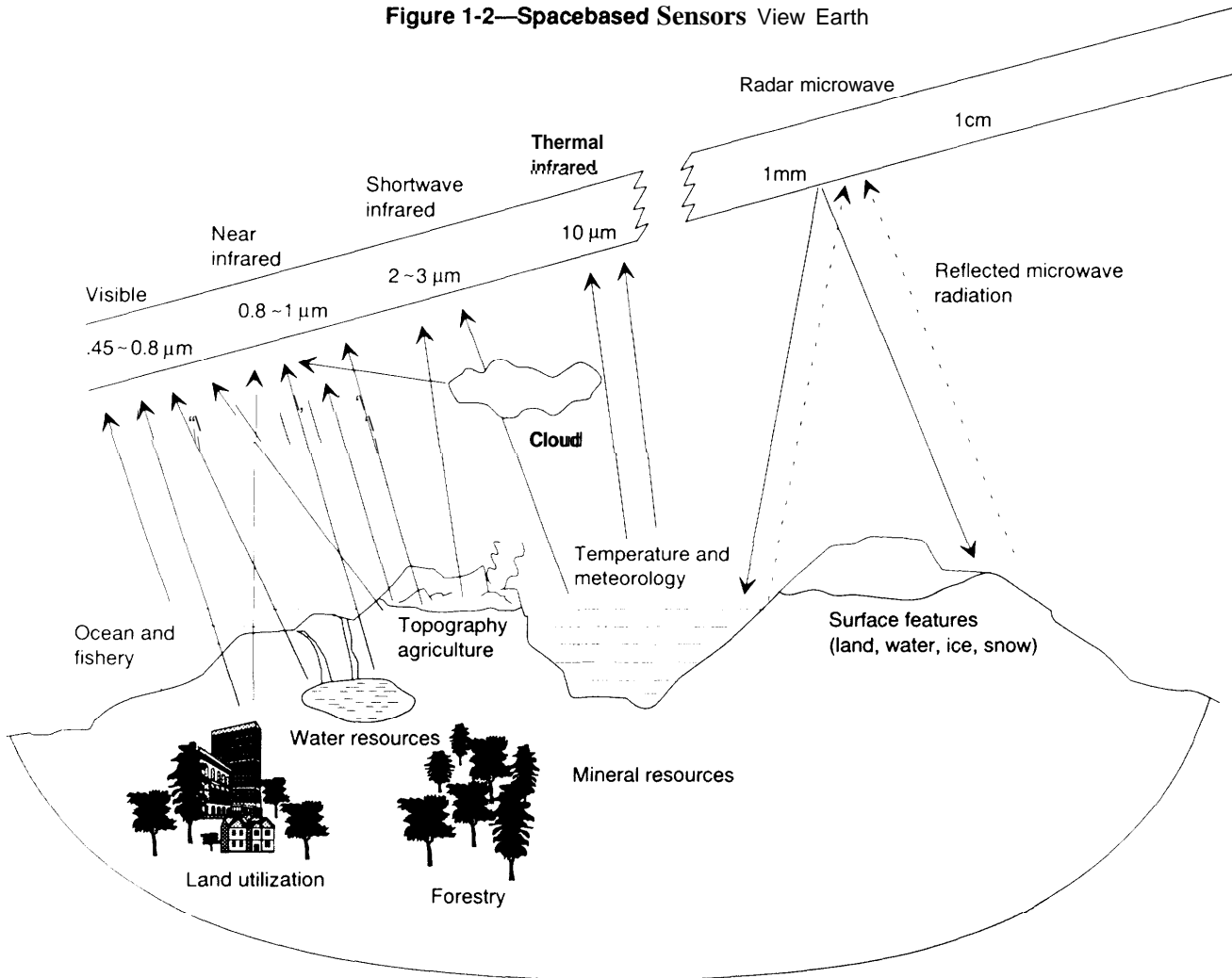

Remote sensors detect reflected energy in the visible and infrared portions of the spectrum. The intensity and extent of this energy reveals much about Earth's surface and the lower atmosphere. Satellite- and aircraft-borne radars generate microwave radiation that is reflected by the surface. Returning microwaves (which are not affected by clouds) allow researchers to study land features and observe the extent of snow/ice cover.

SOURCE: Japan Resources Observation System Organization, JERS-1 Program Description; Office of Technology Assessment, 1993.

*Distribution, Pricing, and Applications*, which was released by OTA in July 1992.<sup>4</sup>

### WHAT IS REMOTE SENSING FROM SPACE?

Remote sensing is the process of observing, measuring, and recording objects or events from

a distance. The term was coined in the early 1960s when data delivered by airborne sensors other than photographic cameras began to find broad application in the scientific and resource management communities. Remote sensing instruments measure electromagnetic radiation emitted or reflected by an object (figure 1-2) and either

<sup>4</sup>U.S. Congress, Office of Technology Assessment, *Remotely Sensed Data from Space: Distribution, Pricing, and Applications* (Washington, DC: Office of Technology Assessment, International Security and Commerce Program July 1992).

## 6 | Remote Sensing From Space

### Box 1-B-How Remote Sensors "See" Earth

Earth receives, and is heated by, energy in the form of electromagnetic radiation from the sun (figure 1-3). About 95 percent of this energy falls in wavelengths between the beginning of the x-ray region ( $290 \times 10^9$  meters) and long radio waves (about 250 meters).

Some incoming radiation is reflected by the atmosphere; most penetrates the atmosphere and is subsequently reradiated by atmospheric gas molecules, clouds, and the surface of Earth itself (including, for example, forests, mountains, oceans, ice sheets, and urbanized areas); about 70 percent of the radiation reaching Earth's surface is absorbed, warming the planet. Over the long term, Earth maintains a balance between the solar energy entering the atmosphere and energy leaving it (figure 1-4). Atmospheric winds and ocean currents redistribute the energy to produce Earth's climate.

Clouds are extremely effective unreflecting and scattering radiation, **and** can reduce incoming sunlight by as much as 80 to 90 percent. One of the important functions of future remote sensors will be to measure the effects of clouds on Earth's climate more precisely, particularly clouds' effects on incoming and reflected solar radiation.

Remote sensors may be divided into passive sensors that observe reflected solar radiation or active sensors that provide their own illumination of the sensed object. Both types of sensors may provide images or simply collect the total amount of energy in the field of view:

Passive sensors collect reflected or emitted radiation. These include:

- . an imaging **radiometer** that senses visible, infrared, near infrared, and ultraviolet wavelengths and generates a picture of the object;
- . an atmospheric sounder that collects energy emitted by the atmosphere at infrared or microwave wavelengths. Used to measure temperatures and humidity throughout the atmosphere.

*Active sensors include:*

- a radar sensor that emits pulses of microwave radiation from a radar transmitter, and collects the scattered radiation to generate a picture;
- . a scatterometer that emits microwave radiation and senses the amount of energy scattered back from the surface over a wide field of view. It can be used to measure surface wind speeds and direction, and determine albedo content;
- a radar altimeter that emits a narrow pulse of microwave energy toward the surface and times the return pulse reflected from the surface;
- . a *lidar* altimeter that emits a narrow pulse of laser light toward the surface **and** times the return pulse reflected from the surface.

**SOURCE:** Office of Technology Assessment 1993.

transmit data immediately for analysis or store the data for future transmission (box 1-B). Photographic cameras, video cameras, radiometers, lasers, and radars are examples of remote sensing devices. Sensors can be located on satellites, piloted aircraft, unpiloted aerospace vehicles (UAVS), or in ground stations. Thus, the data acquired by space-based remote sensing feed into a wide array of mapping and other sensing services provided by surface and airborne devices.

## REMOTE SENSING APPLICATIONS

Earth orbit provides unique views of Earth and its systems. Space-based sensors gather data from Earth's atmosphere, land, and oceans that can be applied to a wide variety of Earth-bound tasks (box 1-C). Probably the best known of these applications is the collection of satellite images of storms and other weather patterns that appear in the newspapers and on television weather forecasts each day. Such images, along with soundings and other data, allow forecasters to predict

Figure I-3—incoming, Reflected, and Scattered Solar Radiation

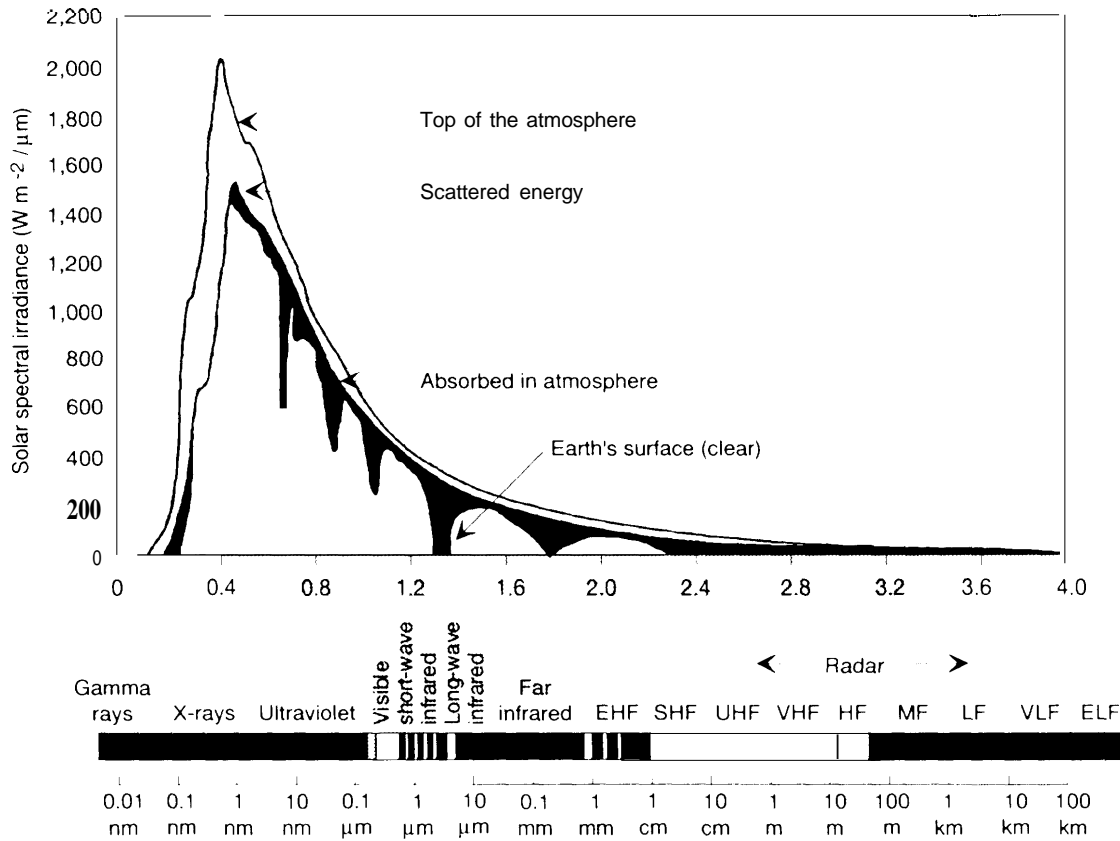

This figure shows the shortwave radiation spectrum for the top of the atmosphere, and as depleted by passing through the atmosphere (in the absence of clouds). Most of the energy that is reflected, absorbed or scattered by the Earth's atmosphere is visible or short-wave infrared energy (from 0.4 micron to 4 microns). In the thermal infra-red, most attenuation is by absorption. Short wavelength radiation is reflected by clouds, water vapor, aerosols and air; scattered by air molecules smaller than radiation wavelengths; and absorbed by ozone in shorter wavelengths (<0.3 micron), and water vapor at the longer visible wavelengths (>1.0 micron).

SOURCE: Andrew M. Carleton, *Satellite Remote Sensing in Climatology*, CRC Press, 1991, pp. 44-45.

the paths of severe storms as they develop, and to present dramatic, graphic evidence to the public. When large storms head toward populated areas, such as happened after Hurricane Andrew developed in August 1992 (plate 1), consecutive satellite images, combined with other meteorological data, coastal topography, and historical records, provide the basis on which to predict

probable trajectories and to issue advance warning about areas of danger.<sup>5</sup> U.S. and foreign environmental satellites also provide valuable data on atmospheric temperature, humidity, and winds on a global scale.

Government agencies with the responsibility of managing large tracts of land, or of providing information regarding land conditions, make use

<sup>5</sup>Thousands of people evacuated south Florida and low lying areas near New Orleans before the September 1992 Hurricane Andrew struck land.

Figure 1-4-Earth's Radiation Budget



Earth's radiation budget is the balance between incoming solar radiation and outgoing radiation. Small changes in this balance could have significant ramifications for Earth's climate. Incoming solar radiation is partially reflected by the atmosphere and surface(30%). The Earth reemits absorbed energy at longer, infrared wavelengths. Some of this energy is trapped by natural and anthropogenic atmospheric gases-the greenhouse effect.

SOURCE: Japan Resources Observation System Organization, Office of Technology Assessment, 1993.

of data from the Landsat or the French SPOT series of land remote sensing satellites (table 1-2). They also use data from the NOAA Advanced Very High Resolution Radiometer (AVHRR) to create vegetation maps (plate 2). Commercial data users with interests in agriculture and forestry, land use and mapping, geological mapping and exploration, and many other industrial sectors also use data acquired from the land remote sensing satellite systems.<sup>6</sup>

Data gathered by recently launched foreign synthetic aperture radar instruments **on European** and Japanese satellites provide information concerning ocean currents, sea state, sea ice, and ocean pollution for both governmental and commercial applications. U.S. satellites have made significant contributions to the science of radar sensing and the measurement of Earth's precise shape.<sup>7</sup> The U.S./French TOPEX/Poseidon satellite, launched in 1992, will provide measurements

<sup>6</sup>The city of Chicago also used LandSat and SPOT data in the aftermath of flooding in its underground tunnels in early 1992.

<sup>7</sup>I.e., Earth's geoid.

### Box I-C-The Use of Satellite Remote Sensing

Remote sensing from space provides Scientific, industrial, civil governmental, military, and individual users with the capacity to gather data for a variety of useful tasks:

1. simultaneously observe key elements of vast, interactive Earth systems (e.g., clouds and ocean plant growth);
2. monitor clouds, atmospheric temperature, rainfall, wind speed, and direction;
3. monitor ocean surface temperature and ocean currents;
4. track anthropogenic and natural changes to environment and climate;
5. view remote or difficult terrain;
6. provide synoptic views of large portions of Earth's surface, unaffected by political boundaries;
7. allow repetitive coverage over comparable viewing conditions;
8. determine Earth's gravity and magnetic fields;
9. identify unique geologic features;
10. perform terrain analysis and measure moisture levels in soil and plants;
11. provide signals suitable for digital or optical storage and subsequent computer manipulation into imagery; and
12. give potential for selecting combinations of spectral bands for identifying and analyzing surface features.

In addition, data from space provide the following advantages:

1. Convenient *historic record, stored on optical or magnetic media and photographs* each data record, when properly calibrated with in situ data, establishes a baseline of critical importance in recognizing the inevitable environmental and other changes that occur.
2. Tool *for inventory and assessment*: satellite images can be used whenever a major natural or technological disaster strikes and massive breakdowns of communication, transportation, public safety, and health facilities prevent the use of normal means of inventory and assessment.
3. *Predictive tool*: property interpreted data used with models can be used to predict the onset of natural and technological disasters.
4. *Planning and management tool*: data can be used for a variety of planning and management purposes.

SOURCE: Office of Technology Assessment, 1993.

of global ocean topography and ocean circulation (plate 8).

All of the preceding satellite types also generate data vital to understanding global change.

When properly archived and made available to the research community, these data can result in information useful for modeling the effects of climate and environmental change.

## 10 I Remote Sensing From Space

Table 1-2--Summary of Land Remote Sensing Applications

---

<p><i>Agriculture</i></p> <ul style="list-style-type: none"> <li>Crop inventory</li> <li>Irrigated crop inventory</li> <li>Noxious weeds assessment</li> <li>Crop yield prediction</li> <li><b>Grove surveys</b></li> <li><b>Assessment of flood damage</b></li> <li><b>Disease/drought monitoring</b></li> </ul> <p><i>Forestry and rangeland</i></p> <ul style="list-style-type: none"> <li><b>Productivity assessment</b></li> <li><b>Identification of crops, timber and range</b></li> <li><b>Forest habitat assessment</b></li> <li><b>Wildlife range assessment</b></li> <li><i>Fire potential/damage assessment</i></li> </ul> <p><b>Defense</b></p> <ul style="list-style-type: none"> <li><b>Mapping, charting, and Geodesy</b></li> <li><b>Terrain analysis</b></li> <li><b>Limited reconnaissance</b></li> <li><b>Land cover analysis</b></li> </ul> <p><i>Land resource management</i></p> <ul style="list-style-type: none"> <li><b>Land cover inventory</b></li> <li><b>Comprehensive planning</b></li> <li><b>Corridor analysis</b></li> <li><b>Facility siting</b></li> <li><b>Flood plain delineation</b></li> <li><b>Lake shore management</b></li> </ul> <p><i>Fish and wildlife</i></p> <ul style="list-style-type: none"> <li><b>Wildlife habitat inventory</b></li> <li><b>Wetlands location, monitoring, and analysis</b></li> <li><b>Vegetation classification</b></li> <li><b>Precipitation/snow pack monitoring</b></li> <li><b>Salt exposure</b></li> </ul>	<p><i>Environmental management</i></p> <ul style="list-style-type: none"> <li>Water quality assessment and planning</li> <li>Environmental and pollution analysis</li> <li>Coastal zone management</li> <li><b>Surface mine inventory and monitoring</b></li> <li><b>Wetlands mapping</b></li> <li><b>Lake water quality</b></li> <li><b>Shoreline delineation</b></li> <li><b>Oil and gas lease sales</b></li> <li><b>Resource inventory</b></li> <li><b>Dredge and fill permits</b></li> <li><b>Marsh salinization</b></li> </ul> <p><i>Water resources</i></p> <ul style="list-style-type: none"> <li><b>Planning and management</b></li> <li><b>Surface water inventory</b></li> <li><b>Flood control and damage assessment</b></li> <li><b>Snow/ice cover monitoring</b></li> <li><b>Irrigation demand estimates</b></li> <li><b>Monitor runoff and pollution</b></li> <li><b>Water circulation, turbidity, and sediment</b></li> <li><i>Lake eutrophication survey</i></li> <li><b>Soil salinity</b></li> <li><b>Ground water location</b></li> </ul> <p><i>Geological mapping</i></p> <ul style="list-style-type: none"> <li><b>Lineament mapping</b></li> <li><b>Mapping/identification of rock types</b></li> <li><b>Mineral surveys</b></li> <li><b>Siting/surveying for public/private facilities</b></li> <li><b>Radioactive waste storage</b></li> </ul> <p><i>Land use and planning</i></p> <ul style="list-style-type: none"> <li><b>Growth trends and analysis</b></li> <li><b>Land use planning</b></li> <li><b>Cartography</b></li> <li><b>Land capacity assessment</b></li> <li><b>Solid waste management</b></li> </ul>
---	---

---

SOURCE: Office of Technology Assessment, 1993.

# Remote Sensing and the U.S. Future in Space 2

**C**ivilian satellite remote sensing has demonstrated its utility to a variety of users. Its future will depend on how well the systems meet the needs of data users for:

- . monitoring the global environment;
- . long-term global change research and assessment;
- . monitoring and managing renewable and nonrenewable resources;
- mapping, charting, and geodesy; and
- . national security purposes.

The future of satellite remote sensing will also be closely tied to the overall direction and strategy of the U.S. civilian and military space programs, which are changing in response to broadening U.S. political and economic agendas. The National Oceanic and Atmospheric Administration (NOAA), National Aeronautics and Space Administration (NASA), Department of Defense (DoD), and the Departments of Interior (DOI), Agriculture (DOA), and Energy (DOE), maintain substantial expertise in remote sensing. **The diversity of remote sensing applications in government and the private sector, and the potential conflict between public and private goods greatly complicate the task of establishing a coherent focus for space-based remote sensing programs.**

## THE CHANGING CONTEXT OF SATELLITE REMOTE SENSING

For the past several years, representatives from government, industry, and academia have engaged in a vigorous debate over

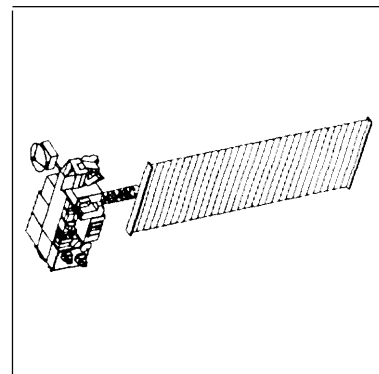



## 12 I Remote Sensing From Space

the future of America's civilian space program.<sup>1</sup> This debate, spurred in part by the end of the Cold War and other dramatic changes in the world's political, economic, and environmental fabric, has reaffirmed the fundamental tenets of U.S. civilian space policy, first articulated in the National Aeronautics and Space Act of 1958. Participants in this debate have generally agreed that publicly supported U.S. space activities should:

- demonstrate international leadership in space science, technology, and engineering;
- contribute to economic growth;
- enhance national security;
- support the pursuit of knowledge; and
- promote international cooperation in science.<sup>2</sup>

Policymakers further agree that U.S. space activities should:

- . include consideration of commercial content;<sup>3</sup> and
- . support research on environmental concerns, including the U.S. Global Change Research Program.<sup>4</sup>

In addition, policymakers have generally supported the four major program elements of U.S. civilian space efforts—space science, environmental observations conducted from space, maintaining a piloted space transportation program, and developing a permanent human presence in space. However, policymakers continue to debate, primarily through the budget and appropriations processes, how much to invest in space

activities relative to other federally funded activities, and what weight to give each element of the U.S. space program.<sup>5</sup> The yearly distribution of priorities within the overall civilian space budget will have a marked effect on how much benefit the United States will derive from remote sensing activities.

For most of the first three decades of the U.S. space program, weather monitoring and military reconnaissance have exerted the primary influences on remote sensing planning and applications. More recently, worldwide concern over the degradation of local environments and the increasing threat of harmful global change from anthropogenic causes have begun to influence the direction of the U.S. space program. Scientists disagree over the magnitude of potential global change, its possible consequences, and how to mitigate them. Yet they do agree that future environmental changes could affect the global quality of life and threaten social structure and economic viability. Because adaptation to, and remediation of, environmental change could be expensive, predicting the extent and dynamics of change is potentially very important. Scientists face two major impediments in attempting to understand whether harmful global change is occurring and, if so, how to mitigate its effects: large uncertainties in existing climate and environmental models, and large gaps in the data that support these predictive models. Hence, the United States has decided to increase the funding allocated to characterizing and understanding the processes of global environmental change.

---

<sup>1</sup>See, for example: Vice President's Space Policy Advisory Board, *A Post Cold War Assessment of U.S. Space Policy* (Washington DC: The White House, December 1990); Advisory Committee on the Future of the U.S. Space Program, *Report of the Advisory Committee on the Future of the U.S. Space Program* (Washington DC: U.S. Government Printing Office, December 1990).

<sup>2</sup>*The National Aeronautics and Space Act of 1958* (Public Law 85-568), Sec. 102.

<sup>3</sup>1986 amendment to the National Aeronautics and Space Act of 1958; *A Post Cold War Assessment of U.S. Space Policy*, op. cit.; *Report of the Advisory Committee on the Future of the U.S. Space Program*, op. cit.

<sup>4</sup>*A post cold war Assessment Of U.S. Space Policy*; op. cit.; *Report of the Advisory Committee on the Future of the U.S. Space program*, op. cit.

<sup>5</sup>Note, for example, that funding for space station *Freedom* has survived three major attempts within Congress to terminate it. Opponents of the space station have vowed to continue their efforts to terminate the space station program in the 103d Congress.

Figure 2-1—1992 and 1993 U.S. Global Change Research Program Budgets, by Agency

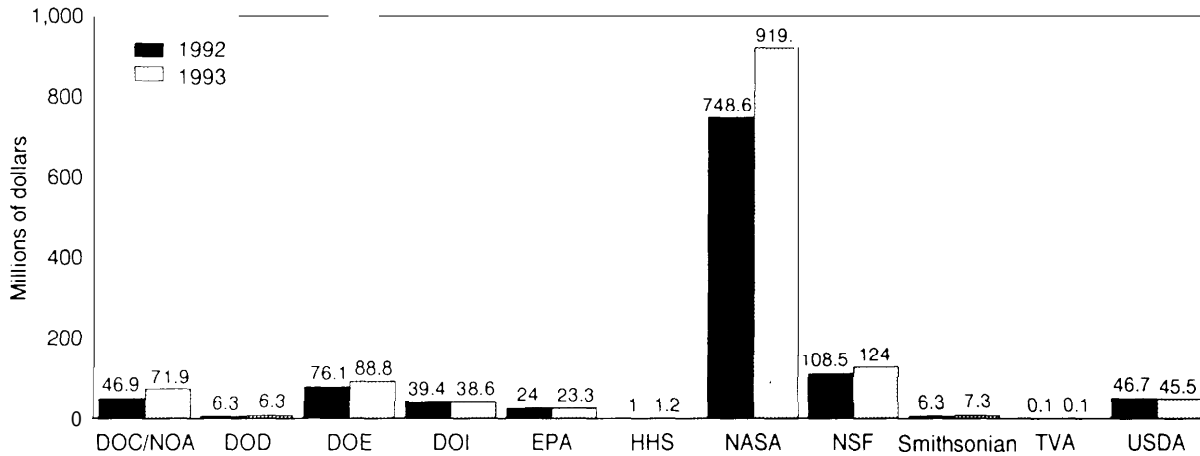

KEY: DOC/NOAA=Department of Commerce/National Oceanographic and Atmospheric Administration; DOD=Department of Defense; DOE=Department of Energy; DOI=Department of Interior; EPA=Environmental Protection Agency; HHS=Health and Human Services; NASA=National Aeronautics and Space Administration; NSF=National Science Foundation; Smithsonian=Smithsonian Institution; TVA=Tennessee Valley Authority; USDA=US Department of Agriculture.

SOURCE: U.S. Global Change Research Program.

Several Federal agencies are involved in gathering global change data and/or analyzing them to provide environmental information. The U.S. Global Change Research Program (USGCRP) was organized to coordinate the Federal global change research effort and give it focus and direction. The interagency Committee on Earth and Environmental Science (CEES) oversees the development and implementation of USGCRP.<sup>6</sup> CEES was established to advise and assist the Federal Coordinating Council for Science, Engineering Sciences, and Technology (FCCSET) within the White House Office of Science and Technology Policy. For fiscal year 1993, Congress appropriated \$1.327 billion among Federal agencies for global change research (figure 2-1).<sup>7</sup> NASA's spending on global change research equals about 69 percent of this total. Thus, **in budget terms, NASA has become the de facto lead agency for global change research. In large part this follows from the fact that space systems are inherently costly to build, launch, and operate.**

**Because space-based remote sensing offers a broad scale, synoptic view and the potential to create consecutive, consistent, well-calibrated data sets, it provides a powerful means of gathering data essential to understanding global environmental change.** Space-based remote sensing also contributes substantially to general progress in the Earth sciences necessary to model environmental processes and interpret observed environmental changes. However, sensors based on satellite platforms have significant limitations of spatial resolution, flexibility, and timeliness. For many important global change research questions, sensors mounted on airborne platforms and surface facilities provide data much more effectively or efficiently (see app. B). Thus, the space component is only one aspect of these activities, and must be planned in conjunction with the other components as an integrated data collection system.

<sup>6</sup>Through its Subcommittee on Global Change Research.

<sup>7</sup>The President's Budget called for devoting \$1.372 billion to global change research programs. The appropriated level for fiscal year 1992 was \$1.11 billion.

## NOAA'S ENVIRONMENTAL EARTH OBSERVATIONS

NOAA's operational meteorological satellite systems, managed by the National Environmental Satellite, Data and Information Service (NESDIS), consist of the Geostationary Operational Environmental Satellites (GOES—figure 2-2) and the Polar-orbiting operational Environmental Satellite (POES), also referred to as the Television Infrared Observing Satellites (or TIROS—see figure 2-3). GOES satellites, which orbit at geostationary altitudes,<sup>8</sup> provide both visible-light and infrared images of cloud patterns, as well as “soundings,” or indirect measurements, of the temperature and humidity throughout the atmosphere. NOAA has been operating GOES satellites since 1974. Data from these spacecraft provide input for the forecasting responsibilities of the National Weather Service, which is also part of NOAA. Among other applications, the GOES data provide advance warning of emerging severe weather, as well as storm monitoring.

The POES satellites, which circle Earth in low polar orbits,<sup>9</sup> provide continuous, global coverage of the state of the atmosphere, including elements of the weather such as atmospheric temperature, humidity, cloud cover, and ozone concentration; surface data such as sea ice and sea surface temperature, and snow and ice coverage; and Earth's energy budget. The National Weather Service also uses these satellite data to create its daily weather forecasts.

Data from both satellite systems also contribute to the long-term record of weather and climate, maintained by NOAA in its archives.<sup>10</sup> The data that NOAA has already collected and

Figure 2-2—The Geostationary Operational Environmental Satellite

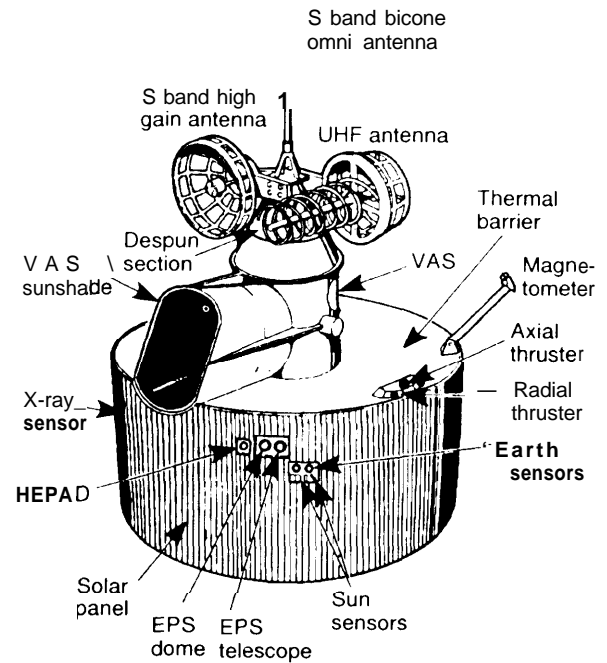

SOURCE: Loral Corp.

archived constitute an important resource for the study of global change. NOAA and NASA have begun to assemble data sets from these archives for use in global change research projects. However, the data are also limited because the satellite instruments are not calibrated to the level required for detecting subtle changes in global climate, or minute environmental responses to climate change. If future sensors aboard NOAA's satellites were to incorporate better calibration techniques, they could make more substantial contributions to global change research. **If Congress believes it is important to improve the utility of data gathered from the NOAA sensors for**

<sup>8</sup> Geostationary orbit is a special case of the geosynchronous orbit in which satellites orbit at the same rate as any point on Earth's equator. A geostationary satellite appears to maintain the same position above the equator throughout a 24-hour cycle, and is therefore able to monitor weather conditions within its field of view on a continuous basis.

<sup>9</sup> Satellites in polar orbit circle in orbits that pass over the poles. They are therefore capable of gathering data from the entire surface as the Earth spins on its axis. The revisit period of these satellites depends on the altitude at which they orbit and the field of view of the sensing instrument.

<sup>10</sup> The NOAA WMO World Climatic Data Center, Asheville, NC; National Oceanographic Data Center, Washington, DC; and National Geophysical Data Center, Boulder, CO.

Figure 2-3-NOAA-9, One of the Polar-Orbiting Operational Satellite Series

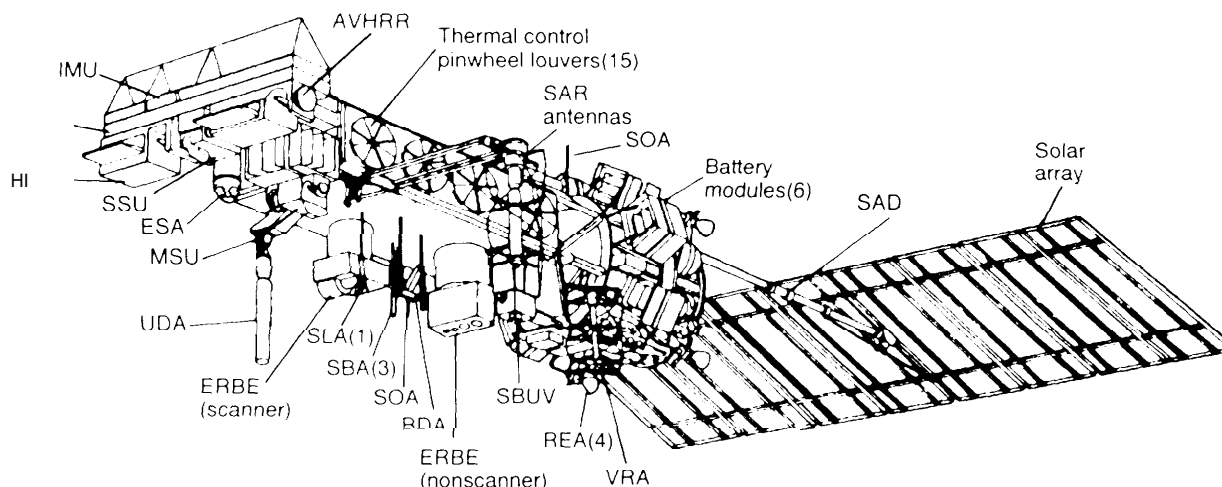

NOAA has launched 12 satellites in this series, also known as the TIROS satellites. NOAA-9 is only partially operational, but its Earth Radiation Budget Sensor (ERBE) continues to provide information to climate researchers.

SOURCE: Martin Marietta Astro Space.

**global change research it may wish to direct NOAA to plan for sensors with more sensitive calibration. Because improved calibration would require moderate additional cost, Congress would also need to increase NOAA's budget for satellite procurement and operation.**

The term "operational" applied to NOAA's satellite systems refers primarily to the way in which they are managed. Such systems have a large established base of users who depend on the regular, routine delivery of data in standard formats. Significant changes in data format or in the types of data delivered can mean great expense for these users. Gaps or loss of continuity in the delivery of data may also have a substantial negative economic impact. Research satellite systems, on the other hand, generally have short-term (3 to 5 years) commitments from agencies, and have a much smaller base of users. Because these users may also directly contribute to instrument design, they are more able to adjust to major changes in data format.

## DEFENSE METEOROLOGICAL SATELLITE PROGRAM

The Air Force Space Command operates the Defense Meteorological Satellite Program (DMSP—figure 2-4), to support DoD's special needs for weather data. DMSP employs a satellite platform very similar to the NOAA POES system, and operates in near-polar orbit, but carries somewhat different instruments.

Critics of the policy of maintaining separate polar orbiting systems argue that the United States cannot afford both systems.<sup>11</sup> DoD and NOAA counter that each satellite system serves a unique mission. The NOAA satellites routinely provide data to thousands of U.S. and international users. DMSP serves a variety of specialized military needs and provides valuable microwave data to the civilian community. Previous attempts to consolidate the two systems have resulted in increased sharing of data and other economies. However, because of the different requirements

<sup>11</sup> U.S. Congress, General Accounting Office, NSIAD 87.107, *U.S. Weather Satellites: Achieving Economies of Scale* (Washington, DC: U.S. Government Printing Office, 1987).

## 16 | Remote Sensing From Space

for data from the two existing systems, such efforts have not led to an integrated system.

**Congress may wish to revisit the question of the possible consolidation of DMSP and the NOAA polar orbiting system as it searches for ways to reduce the Federal deficit.** Such a study should look for innovative ways for NOAA and DoD to work in partnership to carry out the base missions of both agencies.

### NASA'S MISSION TO PLANET EARTH

In conjunction with its international partners, the United States plans a program of civilian Earth observations to provide, by the early years of the next century, the comprehensive collection of data on resources, weather, and natural and human-induced physical and chemical changes on land, in the atmosphere, and in the oceans. These programs are unprecedented in both their scope and their cost.

NASA's Earth Observing System (EOS) of satellites is the centerpiece of NASA's Mission to Planet Earth. It is being designed to provide continuous high-quality data over 15 years<sup>12</sup> that can be related to the scientific study of:

1. large-scale transport of water vapor;
2. precipitation;
3. ocean circulation and productivity;
4. sources and sinks of greenhouse gases (gases such as carbon dioxide and methane that contribute to greenhouse warming) and their transformations, with emphasis on the carbon cycle;
5. changes in land use, land cover, and the hydrology and ecology of the land surface;
6. glacier and polar ice sheets and their relationship to sea-level;

7. ozone and its relationship to climate and the biosphere; and

8. the role of volcanic activity in climate change.

EOS planners expect these data to assist in understanding and monitoring the physical, chemical, and biological processes of global change, predicting the future behavior of Earth systems, and assessing how to react to global change.

Measurements of these global change processes can be divided into two types:<sup>13</sup>

1. Long-term monitoring—to determine if climate is changing, to distinguish anthropogenic from naturally induced climate change, and to determine global radiative forcings and feedback.
2. "Process" studies—detailed analysis of the physics, chemistry, and biology that govern processes ranging from the formation of the Antarctic ozone hole to the gradual migration of tree species.

Some scientists have raised concerns over 1) whether the EOS program as currently configured is optimally designed to perform these different missions, 2) whether the EOS program will address the most pressing scientific and policy-relevant questions, and 3) whether important data on issues such as global warming will be available soon enough to assist policymakers. EOS program officials point to repeated and extensive reviews by interdisciplinary panels in the selection of instruments and instrument platforms as evidence that their program is properly focused. The central role of the EOS program has resulted in a USGCRP budget that is heavily weighted toward satellite-based measurements. As a result, some researchers express concern that:

---

<sup>12</sup> To achieve 15-year datasets, EOS 'AM' and 'PM' platforms would be flown 3 times (the **nominal lifetime of these platforms is 5 years**). Scientists expect that 15 years **will** be long enough to **observe** the effects of climate change **caused** by the sunspot cycle (11 years), several El Nines, and eruptions of several major volcanoes. This period would be **sufficient** to observe the effects of large-scale changes such as deforestation. Scientists are less certain whether it will be possible to distinguish the effects of greenhouse gases on Earth's temperature from background **fluctuations**.

<sup>13</sup> See app. B for more **details** of the distinction between **these** hVO **types** of **data**.

Figure 2-4-A Defense Meteorological Satellite

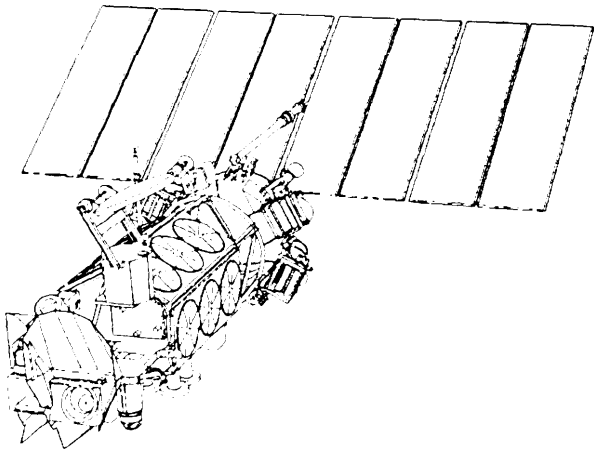

These satellites are similar to the NOAA satellite shown in figure 2-3, although the sensor suite is somewhat different.

SOURCE: Department of Defense.

1. The limitations of satellite-based platforms will prevent process-oriented studies from being performed at the level of detail that is required to address the most pressing scientific questions;
2. Continuous long-term (decadal time-scale) monitoring is at risk, because of the high-cost, long lead times, and intermittent operations that have historically characterized the design, launch, and operation of multi-instrument research satellites.

According to those holding these views, a more balanced EOS program would provide greater support for small satellites, and a more balanced USGCRP program might include greater support for groundbased measurement programs, including ocean measurement systems, and alternative sensor platforms, such as long-duration, high-altitude UAVS. **Greater support for complementary non-space-based elements of the USGCRP could be provided either by redirection of already tight NASA budgets, or from greater support for the USGCRP from the**

**DOE, DoD, and other relevant departments and agencies. If Congress wishes to improve U.S. efforts in global change research it could direct each agency to provide explicit support for data that would complement the data gathered by satellite. This** may require a few tens of millions of dollars of additional funding annually between now and the end of the century. Such additional funds would be quite small compared to the \$8 billion EOS program, but would vastly enhance the value of the data from the EOS satellites.

Redirecting funds from within the EOS program would be extremely difficult because the program has already experienced two significant reductions of scope since Congress approved it as anew start in fiscal year 1991. At the time, NASA had estimated it would need about \$17 billion between 1991 and 2000 to complete the first phase of its EOS plans. Concerns over NASA's plans to rely on a few extremely large, expensive satellite platforms,<sup>14</sup> and funding uncertainties, caused Congress in the fiscal year 1992 appropriations bill to instruct NASA to plan on receiving only \$11 billion during the first phase of EOS.<sup>15</sup> Although this restructuring led to the cancellation of some instruments and a deferral of others, it generally resulted in a lower risk science program that is more heavily focused on climate change. When, during 1992, the magnitude of likely future constraints on the Federal budget became clear, Congress further reduced planned spending for the first phase of EOS to \$8 billion. The congressional action was consistent with an internal NASA effort to reduce the costs of its major programs by about 30 percent. This second reduction of scope has led NASA to cancel additional instruments, increase reliance on foreign partners to gather needed global change data, cut the number of initial data products, and reduce program reserves. Reduction of reserves for instrument design and construction will increase

<sup>14</sup> *Report of the Earth Observing Systems (EOS) Engineering Review Committee, Edward Frieman, chairman, September 1991.*

<sup>15</sup> See ch. 5, *Global Change Research*, for a more detailed account of these congressional fitCtiOm.

**Figure 2-5—Remote Sensing Budgets for NASA, NOAA and DoD**

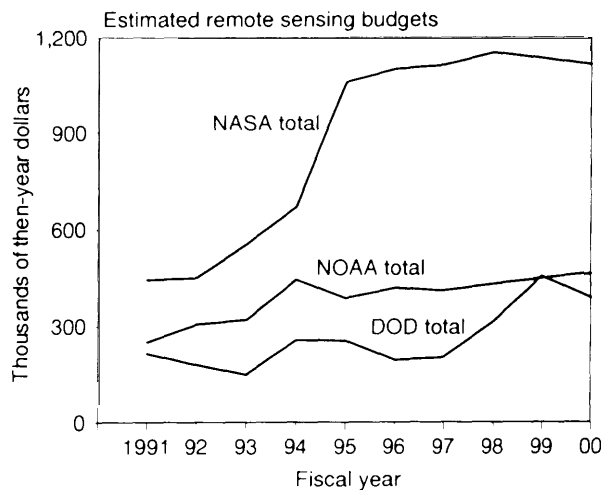

SOURCE: NASA, NOAA, DoD.

the risk that the EOS instruments will not achieve their planned capability. Further reductions in funding for the EOS program are likely to constrain EOS scientists and sharply reduce their flexibility to follow the most important global change science objectives.

Because NASA expects to operate the EOS satellites and its EOS Data and Information System (EOSDIS) for at least 15 years after the launch of the second major satellite in 2000, the program will necessarily take on the characteristics of what has been called an “operational program”—sustained, routine acquisition of data that must be routinely available to researchers and other users on a timely basis. **In order to achieve maximum effectiveness, NASA’s EOS program must be organized and operated with great attention to the regular, timely delivery of data.**

Between now and the end of the century, when the first EOS satellites begin to transmit data to Earth, NASA scientists will rely on a series of Earth Probes and other satellites, including NASA’s Upper Atmosphere Research Satellite, the U.S./French TOPEX/Poseidon, Landsat, and the NOAA operational satellites for global change data. The data from these systems will be critical for early understanding of certain atmospheric and ecological effects.<sup>16</sup>

### NASA’S REMOTE SENSING BUDGET

The Federal budget for building and operating existing and planned civilian satellite remote sensing systems is spread across three agencies—DoD, NASA, and NOAA—but most funds are in NASA’s budget (table 2-1 and figure 2-5). Examining NASA’s budget for remote sensing activities in the context of its other program commitments reveals that the disparity between NASA’s plans and its expected future funding is still growing, despite NASA’s recent efforts to reduce its funding gap by reducing the size of EOS, space station, and space shuttle. NASA has projected an overall budget increase of 13 percent between fiscal year 1993 and fiscal year 1996 (figure 2-6, table 2-2). Should anticipated funding not materialize, NASA will have little budget flexibility to respond to unforeseen problems in its Mission to Planet Earth programs.<sup>17</sup>

The large yearly Federal deficit has created pressure to save money in the discretionary portion of the Federal budget. Civilian space activities account for about 2.8 percent of U.S. discretionary budget authority in fiscal year 1993.<sup>18</sup> In appropriating NASA’s funds for fiscal year 1992, the House and Senate stated that NASA, which receives the lion’s share of the

<sup>16</sup> Ibid.

<sup>17</sup> Several observers have criticized NASA’S earlier budgeting as highly unrealistic. U.S. Congress, **General Accounting Office** GAO/NSIAD-92-278, *NASA: Large Programs May Consume Increasing Share of Limited Future Budgets* (Washington, DC: U.S. General Accounting Office, September 1992). Ronald D. Brunner, “Overmmn.it.rmmt at NASA,” presented at the annual American Astronautical Society Conference, San Francisco, CA, December, 1992.

<sup>18</sup> The discretionary portion of the fiscal year 1993 federal budget request was \$502 billion.

**Table 2-1—Estimated Federal Budgets for Space-Based Remote Sensing Systems: Fiscal Years 1991-2000 (millions of then-year dollars)**

	1991	1992	1993	1994	1995	1996	1997	1998	1999	2000
<b>NASA Total</b> .....	<b>445.0</b>	<b>451.9</b>	<b>572.5</b>	<b>692.5</b>	<b>1,056.9</b>	<b>1,099.3</b>	<b>1,111.9</b>	<b>1,152.0</b>	<b>1,134.0</b>	<b>1,114.7</b>
EOS .....	134.6	145.0	218.8	275.6	519.8	555.3	623.0	671.0	667.0	632.4
EOSDIS .....	36.0	77.7	130.7	182.7	316.7	360.8	329.4	370.6	368.7	381.8
Landsat .....	7.5	7.5	25.0	59.1	61.0	48.0	30.0	32.0	34.0	36.0
Other MTPE systems .....	274.4	221.7	198.0	175.1	159.4	135.2	129.5	78.4	64.3	64.5
<b>NOAA Total</b> .....	<b>251.0</b>	<b>305.8</b>	<b>319.5</b>	<b>444.8</b>	<b>387.6</b>	<b>418.9</b>	<b>411.6</b>	<b>431.0</b>	<b>448.1</b>	<b>466.0</b>
Total polar .....	50.3	130.3	153.9	203.5	184.3	252.3	270.3	261.8	272.3	283.2
Total geostationary .....	108.5	118.0	118.0	191.8	151.8	113.0	85.6	111.3	115.6	120.2
Observing services .....	57.6	55.5	47.6	49.5	51.5	53.6	55.7	57.9	60.2	62.6
Landsat .....	34.6	2.0								
<b>DoD</b> .....	<b>214.7</b>	<b>179.7</b>	<b>149.9</b>	<b>255.4</b>	<b>253.2</b>	<b>194.1</b>	<b>202.4</b>	<b>312.1</b>	<b>455.2</b>	<b>389.0</b>
Landsat 7 .....		300	800	158.0	1340	520	60	2.0	2.0	2.0
DMSP .....	214.7	149.7	69.9	97.4	119.2	142.1	160.4	213.1	262.2	225.0
Landsat 8 .....							36.0	97.0	191.0	162.0
<b>Total</b> .....	<b>910.7</b>	<b>937.4</b>	<b>1,041.9</b>	<b>1,392.7</b>	<b>1,697.7</b>	<b>1,712.3</b>	<b>1,725.9</b>	<b>1,895.1</b>	<b>2,037.3</b>	<b>1,969.7</b>

NOTES: Funds for research use of data are not included.

All 1995-2000 figures are unofficial preliminary estimates.

NASA EOS budget reflects subtraction of "EOS Science" component.

NASA "Other MTPE Systems" reflects the subtraction of MTPE Science, Research Operations Support, ACTS, EOS, EOSDIS, and Landsat from the total MTPE Budget (represents all other MTPE space system development).

NOAA 1999-2000 polar & geostationary budgets are level-funding extrapolations based on 4% inflation adjustments to 1998 estimates.

NOAA Observing Services budget for 1994-2000 is a level-funding extrapolation based on 4% inflation adjustments to 1993 appropriation.

DoD Landsat budgets are from the National Land Remote Sensing Policy Act of 1992 Report 102-539.

Landsat 8 construction, according to present policy, will be performed by DoD, NASA, and/or NOAA. Landsat 8 funding is represented by the addition of then-year dollars, equivalent to the Landsat 7 development budget, to the "Landsat 8" line, beginning in 1997 (adjusted to 4% yearly inflation).

DMSP budget for 2000 is an OTA extrapolation.

SOURCE: National Aeronautics and Space Administration, National Oceanic and Atmospheric Administration, and Department of Defense, 1993.



## 20 I Remote Sensing From Space

**Figure 2-6—NASA's Budget Projections Call for a 13 Percent Budget Increase Between 1993 and 1996**

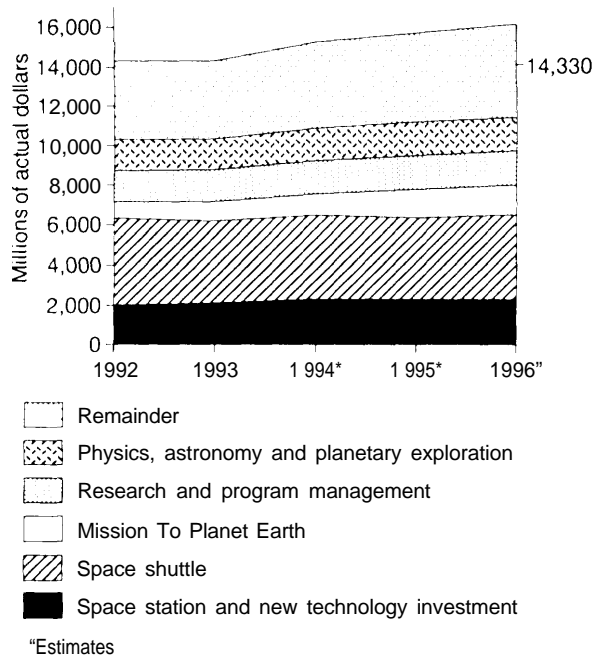

Large programs constitute most of NASA'S budget, leave little flexibility, and require a 13 percent budget increase between FY93 and FY96.

SOURCE: NASA Budget Estimate, Fiscal Year 1994.

civilian space budget, should expect only modest annual increases in its overall budget.<sup>19</sup> Independent reviews of NASA's budget prospects also suggest that NASA may face lower future budgets.<sup>20</sup> NASA's budget in fiscal year 1992 was

\$14.334 billion, a 3.4 percent boost over the fiscal year 1991 budget (table 2-2).<sup>21</sup> For fiscal year 1993, however, NASA's budget is \$14.330 billion. The Clinton Administration is requesting \$15.265 billion for NASA for fiscal year 1994, a one billion dollar increase over the 1993 appropriation.<sup>22</sup>

Figure 2-6 illustrates the required budget increase for NASA's program plan. A level budget (in current year dollars-i.e., one that decreases as inflation rises), or a budget that is increased only slightly, would produce a significant gap between available funding and program needs.

Yearly budgets for MTPE may reach more than 9 percent of NASA's total budget by 1995 (figure 2-7). If NASA neither receives large budget increases nor further reduces the content of its plans,<sup>23</sup> competition for funds within NASA'S budget may force difficult choices among Mission to Planet Earth and other major projects, including those supporting the human presence in space. For example, maintaining NASA's four largest programs at planned levels under a flat agency budget of \$14.3 billion in fiscal year 1996 would require a 30 percent reduction in the rest of NASA's programs for that year.

The primary competition for funding within NASA is likely to be with programs supporting the human presence in space, which today consume more than 70 percent of NASA's budget for

19 "The conferees concur in the Senate language enumerating a series of principles designed to adjust NASA's expectations and strategic planning to leaner budget allocations in the coming years." Conference Report on the 1992 Appropriations for the Veteran's Administration Housing and Urban Development, and Independent Agencies, House of Representatives Report 102-226 (to accompany H.R. 2519), Sept. 27, 1991, p. 54. The Senate language directs that "the agency should assume no more than 5 percent actual growth in fiscal year 1993." Senate Report 102-107, July 11, 1991 (to accompany H.R. 2519), p. 130.

20 For example, the Electronic Industries Association forecasts that NASA's budget will drop by about 8 percent in real terms over the next 4 years. Electronics Industries Association, *Twenty-Eighth Annual EIA Ten-Year Forecast of DoD and NASA Budgets* (Washington DC: Electronics Industries Association October 1992).

21 Congress appropriated \$14.352 billion for the NASA fiscal year budget but later rescinded \$18.4 million from Climatsat and other projects.

22 The amount of this request is similar to the previous administration's request of \$14.993 billion for fiscal year 1993, which Congress reduced substantially.

23 Schedule stretchouts that fail to reduce program commitments only increase the total budget for a project and create a "bow wave" of future budget needs,

## Chapter 2—Remote Sensing and the US. Future in Space 121

Table 2-2—NASA Budgets (millions of then-year dollars)

	1991	1992	1993 Estimate	1994 Request	1995 Estimate	1996 Estimate
Space Station (and new technology) . . . . .	1,900.0	2,002.8	2,122.5	2,300.0	2,300.0	2,300.0
Space transportation capability development . . . . .	602.5	739.7	649.2	649.2	643.3	639.0
Mission to Planet Earth . . . . .	662.3	828.0	937.9	1,074.9	1,448.1	1,508.4
Physics and Astronomy & Planetary Expiration . . . . .	1,442.9	1,570.9	1,577.5	1,631.9	1,709.1	1,676.0
Life Sciences and Space Applications . . . . .	325.9	314.7	350.6	351.0	320.7	282.0
Commercial programs . . . . .	88.0	147.6	164.4	172.0	141.4	132.7
Aeronautical, Transatmospheric, and Space research & technology . . . . .	893.9	1,101.5	1,138.3	1,398.9	1,528.1	1,650.9
Safety, QA, academic programs, tracking and data advanced systems . . . . .	108.1	122.4	148.9	134.4	145.1	152.3
Shuttle production & operations . . . . .	4,066.4	4,325.7	4,069.0	4,196.1	4,042.7	4,201.5
Expendable launch vehicle services . . . . .	229.2	155.8	180.8	300.3	313.7	363.4
Space communications . . . . .	828.8	903.3	836.2	820.5	1,014.6	1,093.3
Construction of facilities . . . . .	497.9	531.4	525.0	545.3	387.2	375.0
Research & program management . . . . .	2,211.6	1,575.8	1,615.0	1,675.0	1,703.0	1,752.0
Inspector general . . . . .	10.5	13.9	15.1	15.5	16.0	16.5
<b>Agency summary . . . . .</b>	<b>13,868</b>	<b>14,334</b>	<b>14,330</b>	<b>15,265</b>	<b>15,713</b>	<b>16,143</b>

SOURCE: National Aeronautics and Space Administration, 1992, 1993.

Figure 2-7—Composition of NASA's Budget, 1990 and 1995

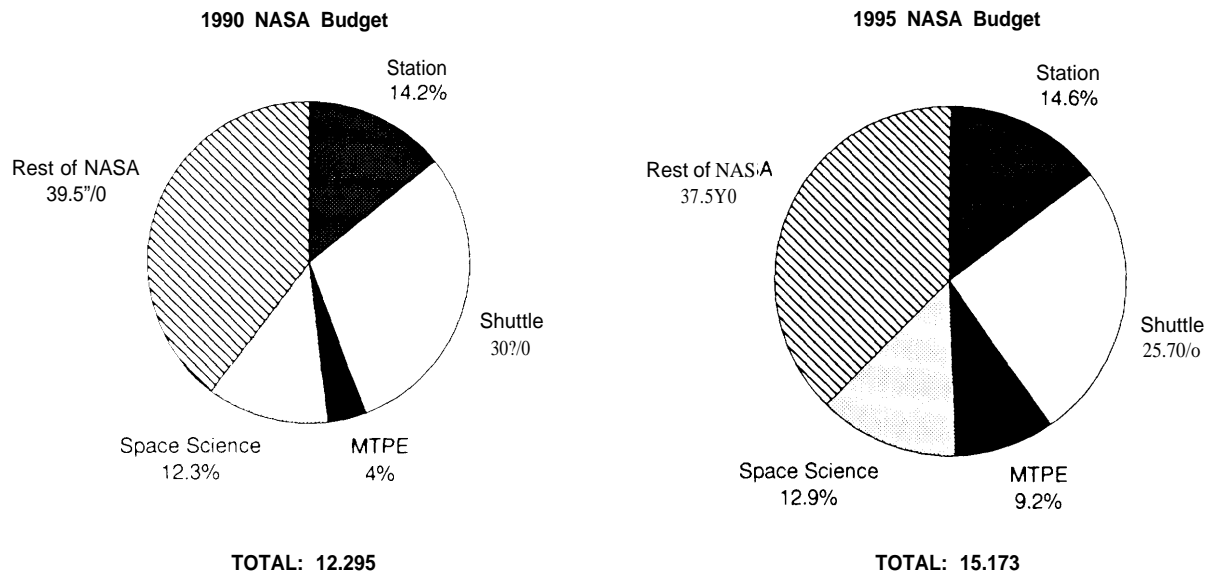

Note the growth of NASA's major programs, including Mission to Planet Earth, which increase to nearly 9 percent of total budget.

SOURCE: NASA Budget Estimate, Fiscal Year 1994; Fiscal Year 1992.

space activities,<sup>24</sup> primarily through the space shuttle and space station *Freedom* programs.<sup>25</sup> Hence, if NASA'S overall budget remains flat or includes **only modest growth, unexpected future increases in either of these two large programs could squeeze MTPE to the point that its effectiveness to support global change research would be severely reduced.** Extremely stringent budget conditions would put Congress and the Clinton administration in the position of having to choose between a robust program that tracks global change and manages Earth resources and a program that supports human presence in space.

The risk of budget surprises related to the support of humans in space is relatively high. As noted in an earlier OTA report, "The United States should expect the partial or total loss of one or more shuttle orbiters some time in the next decade [i.e., the 1990s]."<sup>26</sup> As experienced after the failure of *Challenger in 1986*, the costs of such a loss could reach several billion dollars, even neglecting the costs of repairing or replacing the damaged orbiter.<sup>27</sup> Losing an orbiter would almost certainly delay construction of a space station, causing much higher costs to that program.

Additional budget pressures on MTPE could lead to the use of fewer advanced sensors and other subsystems, or to technology choices that

would raise system operating costs. They could also lead to smaller investments than planned in the distribution and analysis of MTPE data. Furthermore, satellite research and development (R&D) projects, like most other efforts that involve significant technology R&D, tend to grow in cost beyond initial estimates as engineers and scientists face the complexities of design and production, and delays that are beyond the control of the project directors.<sup>28</sup> Cost growth *within the* MTPE satellite development and/or operations programs also would probably reduce the quality or quantity of scientific observations NASA is able to accomplish.

Figure 2-8 indicates cost performance in the major recent remote sensing "New Starts." Four of the five programs have encountered significant cost increases over the original estimates presented to Congress at the time of program approval (New Start).<sup>29</sup> Some cost growth in these programs is the result of additions or changes in program content, while the majority of cost growth is the result of cost increases at contractors. The GOES-Next program has encountered the most substantial cost growth of recent remote sensing programs, with development costs increasing more than two and one half times original cost estimates since program approval by Congress. UARS, on the other hand, was built and flown with no cost growth between

---

<sup>24</sup> That is, excluding \$911 million for aeronautics.

<sup>24</sup> That is, excluding \$911 million for aeronautics.

<sup>25</sup> Direct spending on space station *Freedom* and space shuttle alone consume nearly half of the total budget (table 1-2).

<sup>26</sup> Office of Technology Assessment, *Access to Space: The Future of U.S. Space Transportation Systems* (Washington, DC: U.S. Government Printing Office, May 1990), p. 7. This is based on an assumption of shuttle launch reliability of between 97 and 99 percent (p. 45).

<sup>27</sup> Office of Technology Assessment, *Access to Space: The Future of U.S. Space Transportation Systems* (Washington, DC: U.S. Government Printing Office, May 1990), p. 21.

<sup>28</sup> Notable recent exceptions include the Upper Atmosphere Research Satellite, which was built **within budget and on schedule.**

<sup>29</sup> Figures include launch and operation estimates, except GOES, which **does not include operations.** TRMM and EOS are not included, as these programs have been in development a relatively short time.

Figure 2-8—Cost Performance of Recent Remote Sensing Programs

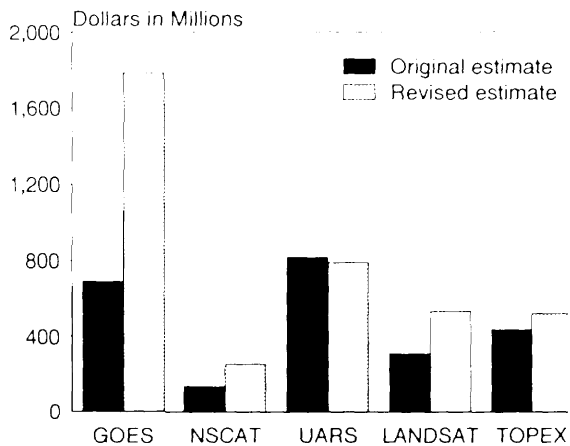

SOURCE: General Accounting Office

post-Challenger reprogramming in 1986 and spacecraft flight.<sup>30</sup>

Among these five recent remote sensing programs, cost increases average 55 percent. In total dollars for all five programs, cost increase is 61 percent. Similar cost growth among EOS and the planned remote sensing New Starts in the future would have a significant adverse impact on the future of remote sensing.

In order to reduce the risk to MTPE, NASA will need to find ways to build in resilience to possible future unforeseen circumstances that would cause budget growth. **In overseeing NASA's allocation of funding for MTPE, Congress may wish to examine how NASA plans to provide contingency funds and other means of ensuring resilience for the program.**

In attempting to find room in NASA's budget to retain EOS activities at a level at or near \$8 billion between 1991 and 2000, Congress could reduce funding for other individual programs, including space shuttle, the advanced solid rocket motor, space station, and space science.

However, in order to retain the existing budget for Earth sciences research by cutting other programs, NASA would either have to stretch out some programs by a significant amount, thereby increasing total program costs,<sup>31</sup> find savings by increasing efficiencies, or cancel some programs.

### NOAA'S REMOTE SENSING BUDGET

NOAA will remain the primary collector of satellite remote sensing data for both meteorological and climate monitoring efforts through the decade of the 1990s. Thus, NOAA could play a strong role in the satellite remote-sensing portion of the USGCRP, while also maintaining and improving its traditional role.<sup>32</sup>

Yet many observers question NOAA's capability and commitment to broader global change research, as well as its ability to secure the funding to support that research. Indeed, NOAA's yearly budgets experience strong competition with other priorities within the Department of Commerce and within Congress' Appropriations Subcommittee on Commerce, Justice, State, and Judiciary.

Table 2-1 provides unofficial planning estimates for NOAA satellite remote sensing. NOAA remote sensing budgets are currently expected to remain in the range of \$400 to \$450 million per year through the rest of the decade, with no major

<sup>30</sup> Reasons attributed to UARS cost performance success include: The UARS project had well-defined scientific requirements, and used the multimission modular spacecraft employed earlier for the Solar Maximum Mission. It also used "plug-in" modules for propulsion, communications, and navigation. Scientists and engineers in the UARS project were well aware of standard interfaces, and apparently no exceptions were allowed by UARS management. The UARS project was also able to depend on steady, full funding from the administration and Congress, which in turn is essential for budget, capability, and schedule performance.

<sup>31</sup> Projects tend to have an optimum pace at which to proceed in order to keep costs at a minimum. Stretching projects as a result of yearly budget limitations requires putting off parts of the project. Because NASA and its contractors must retain much of their experienced workforce on a project, despite the stretched schedule many overhead costs continue, increasing the overall cost of a program.

<sup>32</sup> NOAA has long series of continuous records for important climate variables such as snow cover, ice analysis, sea surface temperature, Earth radiation budget, vegetation index, and ozone. Some of these observations date back to 1960.

funding increases expected. This is in marked contrast to the expansive satellite research efforts underway at NASA. NOAA's smaller increases in yearly remote sensing funding would allow for some relatively minor planned improvements in POES satellites and instruments, and the completion and launch of improved GOES satellites (see ch. 3: Weather and Climate Observations).

Highly constrained NOAA satellite remote sensing budget requests have historically been the norm, as illustrated by Administration attempts to cut the POES program to one satellite, and the termination of the Operational Satellite Improvement Program at NASA in the early 1980s (see ch. 3: Weather and Climate Observations). A more recent example of the effects of limited funding in NOAA is Congress' \$5.3 million cut in the "environmental observing services" line of the 1993 NESDIS budget request.

Recent efforts within NOAA to strengthen advanced sensor research, oceanic remote sensing, and climate observations have been largely unsuccessful. Continuing budget pressures have hampered NOAA's efforts to participate meaningfully in sensor design, mission planning, or data analysis in U.S. and international efforts to develop new satellite remote sensing spacecraft and instruments in the 1990s. Yet these endeavors could build on the substantial investment of other agencies and countries for satellite system hardware to provide additional global change information. For example, NOAA has still not succeeded in securing the relatively small resources (approximately \$6 million) required to assure direct receipt of vector wind data from the NASA scatterometer instrument aboard the Japanese ADEOS satellite,<sup>33</sup> a potentially important enhancement of NOAA's forecast capability.

Observers note that the outcomes of the yearly budget process have caused NOAA's operational remote sensing program to "limp along from year to year. Over the past decade, NOAA has reportedly lost much expertise in remote sensing,

and lost some credibility among the user community. In sum, NOAA satellite remote sensing funding appears to constrain NOAA's ability to serve U.S. needs for remotely sensed data, especially considering the continued importance to the United States of meteorological and long-term climate **change data**.

### THE COSTS AND BENEFITS OF SATELLITE REMOTE SENSING

Between fiscal years 1993 and 2000, the United States plans to spend about \$14 billion to supply remotely sensed data from several systems, or an average of \$1.75 billion per year. Such data serve the U.S. economy by producing information useful for predicting weather, managing natural and cultural resources, economic planning, and monitoring the environment (table 2-3). They will also help scientists detect and understand global change. Multiple systems are needed to provide different kinds of information. Although a systematic study of how costs and benefits compare has not been conducted, costs are likely to be small compared to the benefits that could be obtained with better information generated from remotely sensed data. For example, as noted above, knowing many hours in advance which path a hurricane is likely to take has allowed coastal dwellers to prepare their houses, businesses, and public buildings for the onslaught, and has saved numerous lives as well as millions of dollars in costly repairs. The management of rangeland, forest, and wetlands can also benefit from the large-scale, synoptic information that data from satellite systems can supply.

In the near future, global change research will likely consume the largest share of the satellite remote sensing budget. Here again, the gains in increased knowledge about the effects of harmful change could far outweigh the average yearly costs for space-based global change research (about \$1 billion annually beginning in 1995).

---

<sup>33</sup> ADEOS is scheduled for a 1996 launch.

**Table 2-3—Potential Benefits of Investment in Selected Remote Sensing Systems**

Investment	Expected benefit
Landsat	Improved mapping; better land-use planning, including urban planning, location of dams, waste sites, other public and commercial facilities; more effective management of natural resources; quicker environmental impact assessments; military terrain analysis
GOES-Next	More accurate storm prediction, rainfall measurement resulting in improved ability to warn, prepare, and evacuate affected populations; expanded monitoring of atmospheric humidity
POES K-M	More accurate global precipitation measurements; better global vegetation analyses, resulting in better prediction of drought, crop forecasts, environmental assessments
EOS-AM instruments	Better determination of: role clouds play regulating climate; role of oceans in global warming; carbon cycle
SeaWiFS	Monitor ocean productivity; map ocean production for research, and fishing, shipping, recreational industries; monitor ocean-atmospheric interaction

SOURCE: Office of Technology Assessment, 1993.

Although estimates of the potential costs to sectors of the world's economy from global change are uncertain, they do indicate that such costs could range to tens of billions of dollars per year for the United States alone (box 2-A). Analysts predict, however, that *some* of the costs to the U.S. economy from global warming, taken alone, might be offset by the potential benefits.<sup>34</sup>

The Federal Government may wish to fund programs to mitigate the effects of global change or to adapt to it. The choices of how to respond to the effects of global change, in large part, will be determined by scientists' ability to predict these effects. Satellite remote sensing data *alone* will not necessarily enable the United States to avoid

potential costs, but some fraction of the costs might be saved with improved information derived from satellite data. **Given the large investment the United States and other nations are making in the provision of data from satellite systems, Congress may want to request a systematic study that would compare costs of providing satellite data for monitoring the environment and for global change research with the expected savings better environmental information would provide.** Such an assessment could help allocate resources based on the type of data and utility of their information content.

### DATA CONTINUITY, LONG-TERM RESEARCH, AND RESOURCE MANAGEMENT

To be effective in monitoring global change or in supporting resource management, the delivery of high-quality, well-calibrated, remotely sensed data must be sustained over long periods. Certain data sets, such as those related to Earth's radiation budget, should be acquired continuously over decades. In some cases, data must also be delivered with few or no gaps in the operation of the satellites. For example, losing a Landsat satellite more than a few months before a replacement can be launched would force resource managers to find sources of other, possibly less efficacious, data. Such a data gap would also reduce the ability of global change researchers to follow large-scale changes in the rain forests and other elements of the biosphere.

The need for continuity of data collection and use is recognized in the Land Remote Sensing Policy Act of 1992, which states:

The continuous collection and utilization of land remote sensing data from space are of major benefit in studying and understanding *human*

<sup>34</sup> For example, one effect of global warming could be to lengthen the growing season in areas that are now marginal, thus improving the income from agriculture and other seasonal industries. See William D. Nordhouse, "Economic Approached to Greenhouse Warming," in Rudiger Dornbusch and James M. Poterlan, eds., *Global Warming: Economic Policy Responses* (Cambridge, MA: The MIT Press, 1991), ch. 2.

### Box 2-A—Estimated Costs Resulting From Global Change

Determining the expected costs resulting from various scenarios of climate change is challenging. The economic effects of climate change can be divided into two broad categories. If climate change does occur, every country will endure costs of remediation and costs associated with coping with a changing environment. Costs of remediation involve expenses incurred **adapting to** change and preventing further harmful emissions. For example, included in remediation costs would be the expenses incurred for developing less polluting technologies. Adapting to a changing environment might include the expense of developing new agricultural practices and seeds needed to cope with changing climate and weather patterns. Costs are influenced by technology development, ability of consumers to afford new technologies, government regulations, population growth, demographic trends, and effectiveness of international treaties. Potential costs in several areas could be quite high:

- . costs to agriculture could increase by \$5.9 to \$33.6 billion annually (1992 dollars);
- . forests, a \$13 billion industry whose costs could increase by \$4 billion annually;
- . species loss could lead to damages ranging from a few billion to an order of magnitude higher;<sup>1</sup>
- . for the costs of sea-level rise, estimates range from \$73 to \$111 billion (1965 dollars-cumulative through 2100), to \$373 billion associated with a one-meter rise, an additional \$10.6 billion annually to cover associated economic losses;<sup>2</sup>
- . loss of wetlands, biological diversity, and water resources; and
- . increased fuel **and** power requirements, \$200-300 billion (1986 dollars)<sup>3</sup>

These and all cost estimates associated with climate change should be regarded with extreme skepticism. The art of estimating the costs of global change is still in its infancy. Most published estimates are predicting future events that are not clearly defined and may not even occur. However, what is clear is that should our climate change, the costs of change both in real and in opportunity costs could be enormous.

<sup>1</sup> William R. Cline, *The Economics of Global Warming*, Washington, DC: Institute for International Economics, 1992.

<sup>2</sup> See U.S. Environmental Protection Agency, "The Potential Effects of Global Climate Change on the United States," December, 1989, and U.S. Environmental Protection Agency, "Changing Climate and the Coast," 1980.

<sup>3</sup> U.S. Environmental Protection Agency, "The Potential Effects of Global Climate Change on the United States," December, 1989.

impacts on the global environment, in managing **the** Earth's resources, in carrying out national security functions, and in planning and conducting many other activities of scientific, economic, and social importance.<sup>35</sup>

**If Congress wishes to sustain U.S. efforts to understand and plan for the effects of global change, prepare for more effective management of Earth's resources, and support national security uses of remotely sensed data, it will have to give attention to funding programs that would maintain the continuity of data**

**collection and use over decades. In order to be fully exploited, these calibrated data sets will have to be archived, maintained in good condition, and made readily available to users.**

### DEVELOPING AND EXECUTING A STRATEGIC PLAN FOR SPACE-BASED REMOTE SENSING

The expected constraints on NASA's budget for MTPE speak to another important theme that has emerged during the continuing debate over U.S. space policy — how to accomplish the goals

<sup>35</sup> Public Law 102-555.

for U.S. space activities more efficiently and with greater return on investment. Decisions will be made in an environment in which several U.S. agencies, private companies, and foreign entities pursue remote sensing activities. Greater **program integration, both domestically and internationally, has the potential for reducing costs and redundancy, but risks program delays, compromises on goals, and increased cost.** In the past, the development of new or improved satellite sensors and systems has proceeded according to the specific needs of the funding agency. However, recent experience with data from Landsat and from NOAA and DoD environmental satellites, as well as foreign satellites, demonstrates that the utility of data from these systems extends far beyond the interests of any single agency. Responding to a broader set of needs would likely increase the cost of any single satellite system or sensor because it would put more demands on the instruments and satellite bus. However, increased capability might in time increase the overall benefit of satellite remote sensing to the U.S. taxpayer.

On the domestic level, **the need to maximize the return on investments in remote sensing, particularly for global change research, which dominates expected future spending on civilian remote sensing systems, suggests that NASA, NOAA, DoD, and DOE should combine efforts to develop a single, flexible strategic plan that would:**

- guarantee the routine collection of high-quality measurements of weather, climate, and Earth's surface over decades;
- develop a balanced, integrated, long-term program to gather data on global change that includes scientifically critical observations from aircraft and groundbased platforms, as well as space-based platforms;
- develop appropriate mechanisms for archiving, integrating, and distributing data from

many different sources for research and other purposes; and

- ensure cost savings to the extent possible through incorporating new technologies in system design developed in either the private or public sectors.

Developing a single, flexible plan would require an assessment of whether and where programs of these agencies might conflict, and if so, how they might be harmonized.

## 9 Collecting Routine Earth Observations

**Operational, long-term remote sensing programs such as NOAA's environmental satellite programs and Landsat have generally suffered budget neglect, while the Nation directs attention instead toward new spaceflight missions supported through NASA's budget.** An integrated plan would improve the incorporation of data from DMSP, GOES, POES, and Landsat into operational government programs, as well as into global change research.

The recent shift of operational control of the Landsat system from NOAA to DoD and NASA, as stipulated in the *Land Remote Sensing Policy Act of 1992*,<sup>36</sup> appears to support the routine, long-term provision of Landsat data for the operational use of government, the private sector, and international users. From now into the next century, these data will serve as one of the primary sources for information on the condition of the land and coastal environments. Landsat data will also enable the tracing of long-term, gradual changes to Earth's surface as a result of climate change and/or anthropogenic environmental effects. However, **if Congress and the Administration wish to ensure continuity of data delivery and the continued improvement of Landsat sensors and system components, they will have to maintain a more supportive policy and funding environment for land**

<sup>36</sup> Ibid.



remote sensing than they have during the past decade.

The private sector has developed a growing market for remotely sensed data products, both as buyer and seller, and is a major force in setting standards for remotely sensed data and analytic software. It has also created new data applications, and developed innovative sensors. In the past, many private sector users of remotely sensed data have complained that the government has not taken their needs and interests into account when designing new remote sensing programs. **In order to ensure that Landsat meets the needs of private sector as well as government users, Congress might wish to encourage DoD and NASA to establish an advisory committee to gather input from private industry and academia for building and operating remote sensing satellites.**<sup>37</sup>

For the United States to assure the continual improvement of operational satellite systems, it will need a new approach to developing new sensors. In the past, NASA has generally developed remote sensing systems in response to a set of research interests. As its interests change, NASA's focus on sensors and satellites change with them.<sup>38</sup> In the 1960s and 1970s, some research instruments developed by NASA were incorporated into NOAA's environmental satellites and the Landsat satellites, all of which serve abroad clientele from government and the private sector. However, in recent years, as exemplified by the experience with the development of NOAA's GOES-Next geostationary satellite (see ch. 3: Weather and Climate Observations), the previous arrangement for close cooperation between NASA and NOAA has broken down.<sup>39</sup>

## 1 Global Change Research

In order to be effective in fully understanding Earth systems, global change research requires detailed data about chemical and physical processes in the atmosphere, oceans, and land. Some research problems, particularly those that involve modeling Earth's atmosphere, also require data taken over decades. In order to make the most efficient use of funding resources, the long-term research goals of U.S. global change research must be well coordinated across agencies and with academia. There should also be appropriate means to allocate funding among agencies. The USGCRP has served an important function in focusing the activities of the different agencies toward global change research, but it has relatively little power to adjudicate differences among agencies or to bring discipline to funding decisions. National Space Policy Directive (NSPD) 7, issued on June 1, 1992, established the Space-based Global Change Observation System (S-GCOS), under the aegis of USGCRP, to coordinate the satellite-based global change studies of U.S. agencies.

"In support of the USGCRP the S-GCOS shall:

- Improve our ability to detect and document changes in the global climate system to determine, as soon as possible, whether there is global warming or other potentially adverse global environmental changes; and, if changes are detected, determine the magnitude of these changes and identify their causes.
- Provide data to help identify and understand the complex interactions that characterize the Earth system in order to anticipate

<sup>37</sup> For example, the Land Remote Sensing Policy Act of 1992 mandates the solicitation of advice from "a broad range of perspectives . . . [including] the full spectrum of users of Landsat data including representatives from United States Government agencies, academic institutions, nonprofit organizations, value-added companies, the agricultural, mineral extraction, and other user industries, and the public; Section 101 (c) Landsat Advisory Process.

<sup>38</sup> When NASA was developing the Landsat series of surface remote sensing satellites in the 1970s, some data users complained that NASA's shift of data formats made it difficult for them to plan on routine use of the data.

<sup>39</sup> Department of Commerce, Office of the Inspector General, *National Strategy for Satellite Remote Sensing is Needed*, unpublished report, February 1991.

changes and differentiate between human-induced and natural processes.

- . Provide for a data system to manage the information collected by S-GCOS as an integral part of the Global Change Data and Information System, consistent with the USGCRP data policy.
- . Provide for the development and demonstration of new space-based remote sensing technologies for global change observation and identify candidate technologies for future operational use.<sup>40</sup>

NASA was assigned the lead role in S-GCOS. NSPD7 directs other agencies—including the Departments of Defense, Energy, and Commerce to cooperate in the development and operation of spacecraft and data systems. Because S-GCOS is a recent creation, and because of the recent change of executive branch administration, it is too early to judge its effectiveness in guiding the direction of global change research and other aspects of U.S. satellite remote sensing programs. However, because S-GCOS creates a forum where agencies can share information about existing and future plans for space-based global change research, it has the potential to reduce redundancy and lead to greater sharing of limited resources.

## I Improving the Use of Data

**The** need to be more efficient in using resources dictates greater attention to the ground portions of these programs, which are historically relatively inexpensive compared to procuring new spacecraft and instruments. **Although NASA has demonstrated the ability to collect data from a variety of instruments, it has been less successful in making effective use of them.**

**Historically, data from remote sensing systems have been underutilized, while funds that might be used for data analysis are instead funneled toward the next generation of spacecraft.**

**NOAA and NASA have not made sufficient use of NOAA's rich data archives for global change research.** The Landsat archives held at the U.S. Geological Survey's EROS Data Center are also underutilized for global change research. Such inattention to effective data management and use could undermine global change research efforts, particularly NASA's Earth Observing System (EOS), the largest component in its MTPE program.

Scientists participating in the MTPE have pressed for close attention to the development of a powerful system to store, distribute, and analyze data collected from the various U.S. and international sensors that will contribute to global change research. As a result, NASA is developing the Earth Observing System Data and Information System (EOSDIS), which will be composed of several interconnected data archives distributed around the country (figure 2-9).<sup>41</sup> As part of its EOSDIS efforts, NASA has funded the development of data sets composed of data gathered over the past two decades from sensors aboard the Landsat satellites and form the NOAA operational environmental satellites. NASA's early experience in developing these 'pathfinder' data sets illustrates the difficulties NASA may encounter in dealing with the massive amounts of data from the EOS satellites.<sup>42</sup> It also helps NASA resolve many difficulties before EOS becomes operational. Scientists working on the project are finding it much more difficult than they anticipated to process the data to make them useful to global change researchers. NASA's and NOAA's

@ Nation~ Space Policy Directive 7: Space-based Global Change Observations. The White House, signed by Resident **Bush**, 1 June 1992. This NSDD, which attempts to improve coordination and collaboration in global change **research**, originated in the National Space Council.

41 Hughes Applied Information Services, Inc. won the contract to develop EOSDIS.

42 U.S. Congress, General Accounting Office, GAO/IMTEC-92-79, *Earth Observing System: Information on NASA's Incorporation Of Existing Data Into EOSDIS* (Washington, DC: General Accounting Office, September 1992).

Figure 2-9—The EOSDIS Network

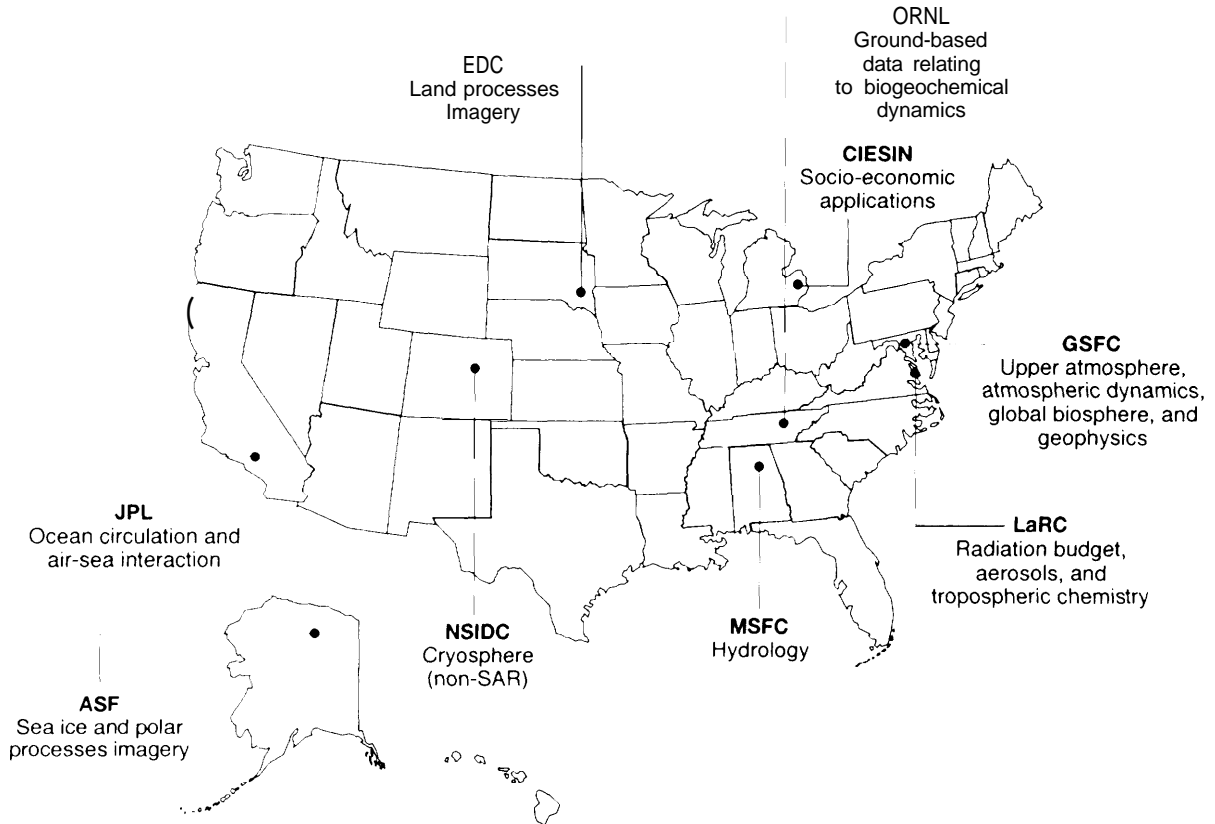

EOSDIS will connect research sites around the country, from Goddard Space Flight Center to the Alaska SAR Facility, via a high-capacity telecommunication link.

KEY: ASF = Alaska Synthetic Aperture Radar Facility; CIESIN = Consortium for International Earth Science Information Network; EDC = Earth Resources Observing System Data Center; GSFC = Goddard Space Flight Center; JPL = Jet Propulsion Laboratory; LaRC = Langley Research Center; MSFC = Marshall Space Flight Center; NSIDC = National Snow and Ice Data Center; ORNL = Oak Ridge National Laboratory.

SOURCE: National Aeronautics and Space Administration.

efforts on the pathfinder data sets also make clear that these data have been underutilized for global change research.

A future report in this assessment will treat data issues in detail. Improving the return on investment in U.S. remote sensing systems will require **more efficient use of existing remote sensing data acquired by satellite. It will also require making more efficient use of data acquired by other means, such as data that could be taken by aircraft, balloons, UAVS, or from groundbased installations. These data**

**are important for remote sensing instrument calibration and validation.**

## 9 Institutional Issues

U.S. research and operational remote sensing activities cut across disciplinary and institutional boundaries. Although existing institutional mechanisms are likely to improve the coordination of U.S. research and operational remote sensing activities, they are unlikely to be sufficient **to develop a long-term integrated plan that allocates resources among the agencies.** Because funding and resource decisions rest largely

with each individual agency and its respective congressional committees, no mechanism exists to enforce collaboration among agencies or adjudicate differences that are likely to arise. **Congress may wish to establish an institutional mechanism to make resource allocation recommendations about remote sensing that extend across agency boundaries.** The Office of Science and Technology Policy, might be given this role. However, as presently constituted, the Office lacks the staff and the mandate to resolve differences among agencies. OMB might be able to assume such a task, but it suffers from a lack of staff and expertise. In addition, it is highly departmentalized. OTA will examine this and other organizational and institutional issues in a future report, which will develop a set of options for Congress to consider.

Greater international coordination and collaboration on sensors and systems, as well as data types and formats, will eventually be needed in order to reap the greatest benefit from the worldwide investment in remote sensing technologies (see ch. 8: International Cooperation and Competition. Sensors on existing satellites provide considerable overlap in capability. Although some redundancy is appropriate in order to give engineers and scientists in different countries experience in designing, operating, and using remote sensing technology, eventually the international community as a whole would be best served by reducing overlap<sup>43</sup> as much as possible and by using the available funds to improve the application of the data or to provide additional capability. The United States and Europe, which are now headed toward the goal of building and operating a single system of two polar orbiting satellites (see ch. 3: Weather and Climate Observations), might consider including Russia in their

plans. The United States and Russia now operate polar orbiting satellites. Closer cooperation between the United States, Europe, and Russia could lead to the development and operation of a single, more capable polar orbiting system. Because of the precarious state of the Russian economy, this might initially require supportive funding from the United States and other countries.

The countries that operate Earth observation satellites have established two mechanisms to foster greater cooperation—the Committee on Earth Observations Systems (CEOS) and the Earth Observation-International Coordination Working Group (EO-ICWG). Both were deliberately created as informal organizations in order to avoid confronting administrative hurdles within each country that a more formal cooperative structure might engender. Countries use CEOS and EO-ICWG to inform members about their plans and to coordinate Earth observations. There is no exchange of funds.

**In the future, the United States may wish to consider leading a broadbased cooperative program to collect, archive, and distribute long-term environmental data sets using sensors and satellites systems similar to those now operated by NOAA.**<sup>44</sup> If properly structured, such an international system could involve the funding and talents of many more nations in building and operating a system. It would also increase our capability to gather and process environmental data sets over the long term. The final report of this assessment will examine the benefits and drawbacks of a broadbased international polar-orbiting system, as well as the related issue of closer cooperation on NOAA's geostationary satellite system.

---

<sup>43</sup> Some overlap in the form of redundancy is useful in order to provide appropriate backups for failed spacecraft or to provide additional coverage. The use of the European *Meteosat-3* spacecraft to provide backup for the aging U. S. geostationary environmental satellite, *GOES-7*, is a case in point.

<sup>44</sup> John McElroy, "The Future of Earth Observations in the USA," *Space Policy*, November 1987, pp. 313-325.

# Weather and Climate Observations 3

**M**any variables determine weather. For example, atmospheric pressure, temperature, and humidity at different altitudes affect the development and progress of storm systems, the amount of precipitation a region receives, and the number of cloudy days. Over time, these factors contribute to the climate on local, regional, and global scales. Throughout the day, sensors located on the land and oceans and in the atmosphere and space:

- take measurements of atmospheric temperature and humidity (essential to understanding weather systems and storm development);
- monitor atmospheric winds (providing critical information on weather patterns);
- take visible-light and infrared images of cloud formations and weather systems;
- monitor changes in solar radiation; and
- measure concentrations of important atmospheric constituents.

Data gathered by these sensors are essential to understanding weather and climate. Despite efforts to date, large gaps still exist in scientists' understanding of the detailed mechanisms of weather and climate and in their ability to predict how weather and climate will change. Climatologists would like more data on atmospheric chemistry and dynamics, the extent of clouds, winds at the oceans surfaces, and upper atmosphere winds. As the recent concern over the degradation of Earth's protective ozone layer demonstrates, human activities alter atmospheric chemical constituents and affect the structure and health of the atmosphere.



### Box 3-A-NOAA's Geostationary Satellite System

The Geostationary Operational *Environmental Satellites* (GOES) maintain orbital positions over the same Earth location along the equator at about 22,300 miles above Earth, giving them the ability to make nearly constant observations of weather patterns over and near the United States. GOES satellites provide both visible-light and infrared images of cloud patterns, as well as "soundings," or indirect measurements, of the temperature and humidity throughout the atmosphere. These data are essential for the operations of the National Weather Service—such data provide advance warning of emerging severe weather, as well as storm monitoring. The vantage point of GOES satellites allows for the observation of large-scale weather events, which is required for forecasting small-scale events. Data from GOES satellites may be received for free directly from the satellite by individuals or organizations possessing a relatively inexpensive receiver.

In order to supply complete coverage of the continental United States, Alaska, and Hawaii, the GOES geostationary satellite program requires two satellites, one nominally placed at 75° west longitude and one at 135° west longitude. The first SMS/GOES was placed in orbit in 1974. However, from 1984-1987 and from 1989 to the present time, as a result of sensor failures and a lack of replacements, only one GOES satellite has been available to provide coverage. GOES-7 is currently located at 112° west longitude, which provides important coverage for the eastern and central United States. Unfortunately, this single satellite is nearing the end of its "design life" and could fail at anytime, leaving the United States with no GOES satellite in orbit. The United States has borrowed a Meteosat satellite from Europe to cover the East Coast and serve as a backup should GOES-7 fail. Meteosat-3 is now positioned at 75° west longitude.

**SOURCE:** National Oceanic and Atmosphere Administration and Office of Technology Assessment, 1993.

By closing these data gaps, scientists hope to understand the forces that affect Earth's weather and determine its climate. They also hope to differentiate natural variability from anthropogenic changes in weather and climate.

Satellite sensors offer wide, repeatable coverage, long-term service, and the ability to monitor several aspects of weather and climate simultaneously. Data from satellites contribute to both short- and long-term weather prediction and modeling and enhance public safety. In the short run, images of weather systems, obtained primarily from satellites in geosynchronous orbit, allow forecasters to predict the probable paths of severe storms. Data collected by polar orbiting satellites concerning the atmosphere, land, and oceans, are invaluable for understanding and modeling atmospheric temperature, humidity, wind, and the extent and condition of global vegetation (plate 3).

### NOAA's OPERATIONAL ENVIRONMENTAL SATELLITE PROGRAMS

As noted earlier, NOAA operates two satellite systems to gather data concerning weather and climate in order to support the national economy and promote public safety.

#### The GOES System

To provide complete U.S. coverage, NOAA normally maintains two GOES satellites in orbit (box 3-A). However, difficulties experienced in constructing the next series of GOES satellites, GOES-Next, and the lack of a backup for the current series, have left the United States dependent on a single satellite, GOES-7, the last in the current series. To maintain critical weather observations over the United States, NOAA has signed an agreement with ESA and Eumetsat (box 3-B), the European Organisation for the Exploitation of Meteorological Satellites,<sup>1</sup> to lend the United

<sup>1</sup>Eumetsat is an intergovernmental organization that operates meteorological satellites. Its satellite systems were developed and built by the European Space Agency.

### Box 3-B—ESA and Eumetsat

The European Space Agency (ESA), a consortium of 13 member states,<sup>1</sup> has been in existence since 1975. ESA has developed and launched weather satellites and Earth remote sensing satellites. ESA has developed two experimental Meteosat spacecraft and an operational series of Meteosats. It is the primary agency responsible for developing remote sensing spacecraft in Europe and plays a major role in coordinating European remote sensing efforts. ESA develops and operates weather monitoring satellites on behalf of the European Organisation for the Exploitation of Meteorological Satellites (Eumetsat).<sup>2</sup> Eumetsat is an intergovernmental organization, established by an international convention that states its primary objective:

... to establish, maintain and exploit European systems of operational meteorological satellites, taking into account as far as possible the recommendations of the World Meteorological Organization.<sup>3</sup>

Some of the same issues that confront NASA and NOAA challenge ESA and Eumetsat. For example, Eumetsat has struggled to clarify its mission with regard to weather forecasting and research. ESA has recently decided to split its payloads between two different copies of a modular polar orbiting spacecraft, one in 1998 for scientific research and a second in 2000 for weather forecasting. Eumetsat heralds this decision, which has extended the organization's mission to environmental research, as leading to a dearer distinction between environmental experimentation and operational meteorology.<sup>4</sup>

<sup>1</sup> Austria, Belgium, Denmark, Germany, France, Ireland, Italy, The Netherlands, Norway, Spain, Sweden, Switzerland, and the United Kingdom; Canada and Finland are associate members.

<sup>2</sup> Eumetsat has 16 members, including Finland, Greece, Portugal, Turkey, and the ESA members excluding Austria.

<sup>3</sup> EUMETSAT Convention, Article 2, 1986.

<sup>4</sup> "Eumetsat Likes Idea of Separate Polar Satellites," *Space News*, June 22, 1992, p. 23.

SOURCE: Office of Technology Assessment, 1993.

States Meteosat-3 to supplement observations from GOES-7 and to stand in should GOES-7 fail (figure 3-1). This arrangement illustrates the high level of international cooperation in meteorological remote sensing, which is carried out in other areas as well. Because **weather patterns move across national boundaries, international cooperation has been an important component in the collection of weather data. Governments need to cooperate with each other in order to follow weather patterns that transcend national boundaries.**

GOES-7 is currently operating well, but it and Meteosat-3 are about one year past their design lives. The first satellite in the series of GOES-Next satellites is scheduled for launch in spring 1994 (figure 3-2). The follow-on GOES-Next satellite has been plagued by technical and

programmatic setbacks that, until the summer of 1992, led to major schedule slips and large cost overruns. Changes in management have resulted in controlled costs and good schedule success. However, until GOES-Next has been successfully launched and placed in operation, the United States faces the risk of losing weather information now provided by geosynchronous satellites.

During the early 1980s, in an effort to improve the satellite data available to the National Weather Service, NOAA funded and NASA developed new, more complex sensor and satellite designs for the GOES series. NOAA termed the new satellite series GOES-Next. GOES-Next will retain the existing visible imaging but also will provide higher resolution infrared imagery to enhance the prediction and monitoring of severe weather. A separate, continuously operating im-

Figure 3-1-Meteosat-3 Images of Earth

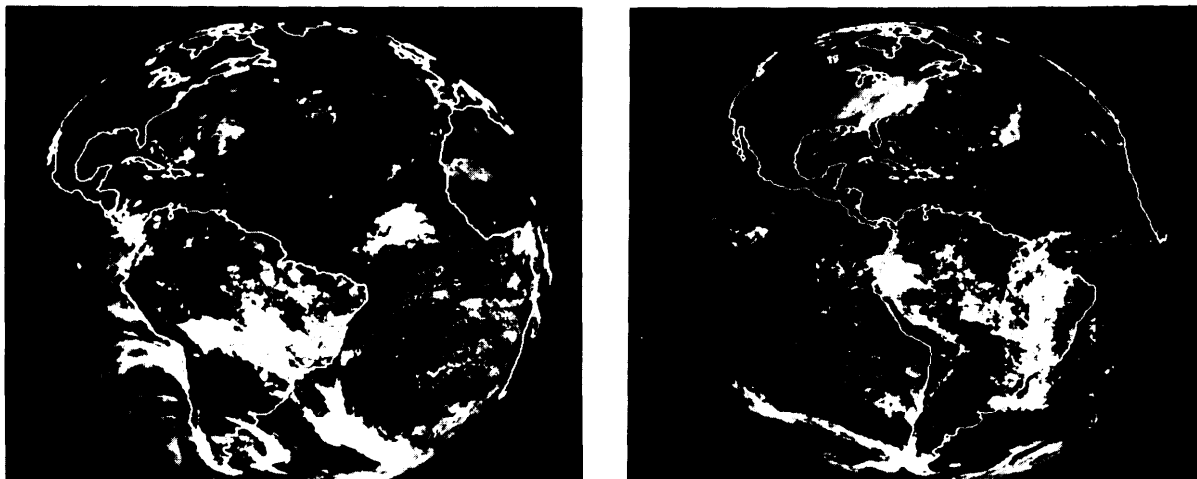

These images were made before and after ESA moved Meteosat-3 westward from its earlier position near 500 west longitude to its current position at 75° west longitude. Meteosat 3, launched in 1988, served as Europe's operational satellite until June 1989, when it was placed in on-orbit storage. In August 1991 ESA reactivated the satellite and moved it from 0° west to 5° west to supplement the U.S. GOES system. Beginning January 27, 1993, ESA moved the satellite 1° per day until it reached 75°, where the second image was taken.

SOURCE: National Oceanic Atmospheric Administration, European Space Agency, Eumetsat.

proved atmospheric sounder<sup>2</sup> should allow for uninterrupted data on the atmosphere, contributing to improved storm prediction.

NOAA and NASA have a history of more than 30 years of cooperation on environmental satellites. NASA developed the first TIROS polar orbiting satellite in 1960, and in 1974 it launched SMS-GOES, the precursor to NOAA's GOES system. Generally NOAA has relied on NASA to fund and develop new sensors, several of which NOAA adopted for its environmental satellites. A 1973 agreement between NASA and NOAA resulted in the Operational Satellite Improvement Program (OSIP) within NASA, which provided funding at the rate of some \$15 million per year to support development of new sensors and other technologies to improve NOAA's operational

satellites. In the 1970s, highly successful cooperation between NASA and NOAA resulted in the development of several sensors, including the Advanced Very High Resolution Radiometer (AVHRR) and the Total Ozone Mapping Spectrometer (TOMS).<sup>3</sup> During the early 1980s, in an attempt to cut its spending on satellite development, NASA eliminated spending on OSIP, leaving NOAA to fund development of GOES-Next, using NASA as the procurement agency. Problems with program management, unexpected technological challenges, and overly optimistic bids accepted from contractors have caused the development of GOES-Next to exceed its original estimated costs by over 150 percent (box 3-C).<sup>4</sup> If Congress wishes NASA to continue to engage **in research and development for NOAA's**

<sup>2</sup> A "sounder" is a sensor that provides data leading to estimates of temperature throughout the atmosphere.

<sup>3</sup> AVHRR and TOMS provide important data on weather, climate, and global change research. See Box 1-G below for descriptions of these sensors.

<sup>4</sup> Including launch costs, the GAO has calculated that the **GOES-Next program**, including development and construction of five satellites, will cost almost \$1.8 billion, compared to its original estimate of \$691 million.



Figure 3-2—Engineering Drawing of GOES-Next

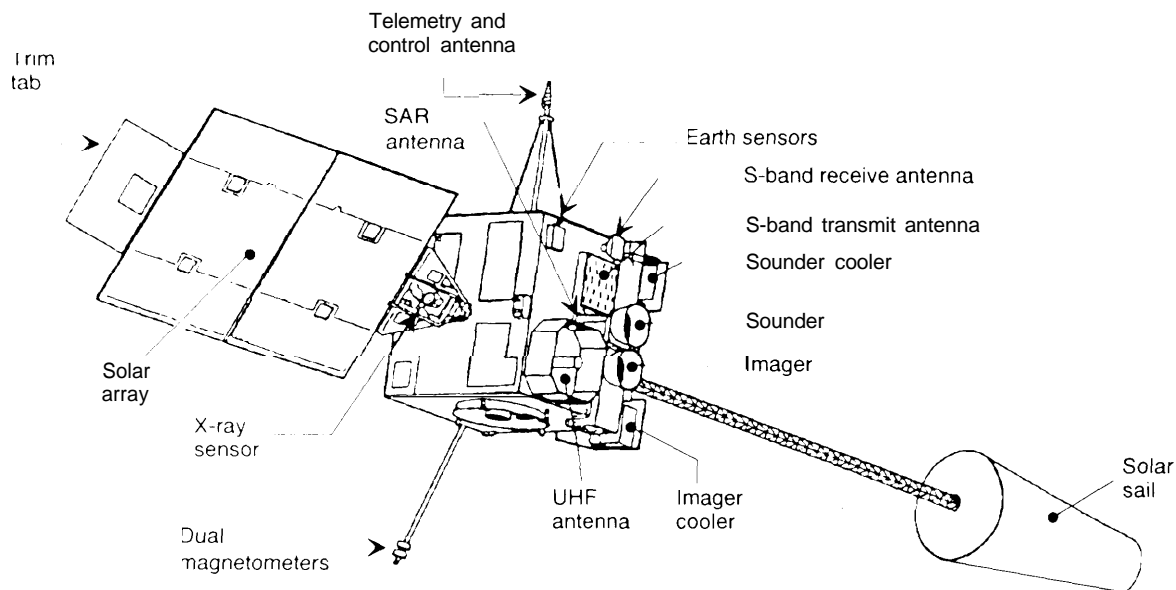

GOES-Next is the new generation of meteorological satellites developed for NOAA and built by Ford Aerospace. The satellite series features improved sounders and imagers, and will serve as the primary observation platform for NOAA after a much-delayed 1994 launch.

SOURCE: National Oceanic and Atmospheric Administration.

operational sensors and satellites, it could direct NASA to reinstate the OSIP budget line for sensor development and provide sufficient funds to support OSIP. In addition, Congress could direct NASA and NOAA to develop a more effective relationship for the development of new operational systems. Alternatively, Congress could fund NOAA sufficiently to allow NOAA to develop its own advanced sensors. However, the latter option would require that NOAA develop sufficient expertise in satellite design and development to manage new development projects, which would likely cost more than directing NASA to take on the task again.

### ~ The POES System

The POES program (box 3-D), like the GOES program, employs a two-satellite system. One

polar orbiter repeatedly crosses the equator at approximately 7:30 am local standard time (the “morning” orbiter) and the other satellite crosses the equator at approximately 1:30 pm (the “afternoon” orbiter). Although NOAA’s funding for the POES system has been highly constrained by tight NOAA budgets and by cost overruns of the GOES program, NOAA has nevertheless managed to keep two operating satellites in orbit at all times.<sup>5</sup> At the same time, it has actively sought international cooperation as a means of spreading the burden for providing important information to all countries of the world, and as a means of reducing U.S. costs.

For the future, NOAA is considering incorporating several of the instruments NASA has under development for the Earth Observing System in its operational satellites. For example, the Atmospheric Infrared Sounder (AIRS), planned as a

<sup>5</sup>In the 1980s, as a cost-cutting measure, the Reagan Administration regularly deleted funding for NOAA’s morning orbiter, but Congress re-appropriated the funding each year.

### Box 3-C Lessons learned From the GOES Experience

The GOES system has been widely praised for its abilities to track both slow moving weather fronts and rapidly developing violent storms. GOES is credited with saving many lives since the first satellite was launched in 1975. For example, GOES images have contributed to improved early warning of violent storms, resulting in a global 50 percent decrease in storm-related deaths. Yet the development of the GOES follow-on, called GOES-Next, has met anything but calm weather. GOES-Next has been beset by management and technical problems that have resulted in a large cost overrun.<sup>1</sup>

NASA and NOAA have a long history of cooperation in developing spacecraft. An agreement between the two agencies, originally signed in 1973, gives the Department of Commerce and NOAA responsibility for operating the environmental systems and requires NASA to fund development of new systems, and fund and manage research satellites. This NASA line item is known as the Operational Satellite Improvement Program, and was usually funded at an average level of about \$15 million per year.<sup>2</sup> Prior to initiating GOES-Next development, this division of labor seemed to work well. NASA had developed the TIROS and Nimbus research satellites, which carry instruments that were eventually transferred to NOAA operational satellite systems. NASA and NOAA budgets and organizational structure were based to an extent on the agreed-upon division of responsibility.

NASA and NOAA cooperation became less effective over time. During the transition to the Reagan Administration in 1981, NASA faced cost overruns with ongoing programs and began to spend more of the available resources, including the line item that was used for NOAA development, on the Space Shuttle. In addition, the Reagan Administration was slow to appoint senior agency management in NASA. As internal pressures mounted, NASA decided not to fund development of NOAA operational sensors and spacecraft. With the concurrence of the Office of Management and Budget, NASA eliminated the budget line used to fund development of new sensors for NOAA systems.

The GOES satellites operating at the time had life expectancies that would carry the program through the late 1980s. NOM decided to build a GOES follow-on by 1989 that included a major design change. The system requirements led to a very sophisticated design. NOAA wanted to improve the sensor's visible and infrared resolution and to operate the sounder simultaneously with the imager. In responding to a GAO investigation of the GOES program, NASA officials agreed that NOAA's requirements would be hard to meet.<sup>3</sup> In an effort to shave

<sup>1</sup> GOES-Next will cost \$1.7 billion; estimated total costs are now over \$1.7 billion, including launch costs, which should average nearly \$100 million per launch.

<sup>2</sup> This figure was significantly higher during the early 1970s.

<sup>3</sup> U.S. - Accounting - Report to the Chairman, Committee on Science, Space, and Technology, House of Representatives, July 1991.

high-resolution instrument that will provide temperature and humidity profiles through clouds, would be a candidate for use on future NOAA satellites.<sup>6</sup> However, NOAA will have to gain extensive experience with the NASA instruments

and the data they provide in order to transfer them to operational use. NASA will also have to take into account the instrumental characteristics necessary for developing an operational sensor. NOAA is also investigating other new instruments to

<sup>6</sup> AIRS will measure outgoing radiation and be able to determine land surface temperature. In addition, the sounder will be capable of determining cloud top height and effective cloud amount, as well as perform some ozone monitoring.

costs, NOAA eliminated the Phase B engineering review, an evacuation of satellite design and design changes.<sup>4</sup> What was not clear to NOAA program managers at the time was how great a departure from the original design was required. NOAA was confronted with the following in deciding how to replace the GOES-D satellite:

- NASA established a policy that future NOAA satellites should be designed to be launched by the Shuttle. The existing GOES design, optimized for launch on an expendable launch vehicle, was not. NASA's policy was subsequently revised after the Challenger disaster in 1986, but the new design (GOES-Next) had already been locked in.
- Several of the early GOES satellites had not demonstrated adequate reliability, failing earlier than expected. This forced a decision to advance the procurement schedule.<sup>5</sup>
- Since NOAA was traditionally an operational entity, it had little hope of receiving approval for satellite R&D funding, yet was pressed to proceed with a follow-on NASA procurement.
- Satellite manufacturers, though aware of the problems with the original GOES design, stated that providing simultaneous imaging and sounding could be incorporated with only modest risk. NOAA and NASA managers were skeptical of these claims, but they also needed to proceed quickly with the new design.
- A detailed interim engineering review for the GOES-Next plan was canceled for budget reasons. This review might have revealed some of the problems contained in the original design.<sup>6</sup>

These factors complicated the decision to proceed with the improvement to GOES, which became known as GOES-Next. The design change dictated by launch capabilities was unavoidable, given NASA's launch policy. NOAA proceeded with an ambitious effort that camouflaged some of the risk involved with developing GOES-Next. Nothing in the history of either of the contractors involved (Ford **Aerospace**<sup>7</sup> and ITT) indicated they were less than qualified for the task.

The experience with GOES-Next highlights the problems of interagency cooperation within the U.S. government. When NASA stopped funding development of operational satellites, agency responsibilities were no longer clear. Funding authority for development of future operational satellites needs to be clarified.

<sup>4</sup> Eric J. Lerner, "Goes-Next Goes Astray," *Aerospace America*, May 1992.

<sup>5</sup> The early GOES satellites (D-H) were plagued with the same problem—a small component that was essential to determining the direction of the field of view of the VAS sensor prematurely failed. The problem was eventually overcome, but not before NOAA was faced with an early replacement for two of its operational satellites.

<sup>6</sup> Lerner, *op. cit.*, footnote 15.

<sup>7</sup> Now part of **Loral** Corporation.

SOURCE: Office of Technology Assessment, 1993.

improve the quality of its POES data collection.<sup>7</sup> Over the years, NOAA has established an enormous base of international data "customers" who depend on the delivery of data of consistent standards and familiar formats. It therefore carefully considers any changes to the format and eschews technical or financial risks to its operations.

The United States historically has transmitted data from the polar metsats at no cost to thousands of U.S. and international users, who collect data using inexpensive Automatic Picture Transmission (APT) recorders or High Resolution Picture Transmission (HRPT) recorders as the satellite passes over. Some 120 governments and thousands of other users around the world benefit from

<sup>7</sup> For example, NOAA and Eumetsat are supporting research on the Interferometer Temperature Sounder (ITS) by the University of Wisconsin and Hughes Santa Barbara Research.

### Box 3-D-NOAA's Polar-Orbiting Operational Environmental Satellite System

The POES satellites follow orbits that pass close to the north and south poles as Earth rotates beneath them. They orbit at about 840 kilometers altitude, providing continuous, global coverage of the state of Earth's atmosphere, including essential parameters such as atmospheric temperature, humidity, cloud cover, ozone concentration, and Earth's energy budget, as well as important surface data such as sea ice and sea surface temperature, and snow and ice coverage. All current and near-future POES satellites carry five primary instruments:

1. *The Advanced Very High Resolution Radiometer/2 (AVHRR/2)* determines cloud cover and Earth's surface temperature. This scanning radiometer uses five detectors to create surface images in five spectral bands, allowing multispectral analysis of vegetation, clouds, lakes, shorelines, snow, and ice.
2. *The High Resolution Infrared Radiation Sounder (HIRS/2)*. *HIRS/2* measures energy emitted by the atmosphere in 19 spectral bands in the infrared region of the spectrum, and 1 spectral band at the far red end of the visible spectrum. HIRS data are used to estimate temperature in a vertical column of the atmosphere to 40 km above the surface. Data from this instrument can also be used to estimate pressure, water vapor, precipitable water, and ozone in a vertical column of the atmosphere.
3. *The Microwave Sounding Unit (MSU)* detects energy in the troposphere in four areas of the microwave region of the spectrum. These data are used to estimate atmospheric temperature in a vertical column up to 100 km high. Because MSU data are not seriously affected by clouds, they are used in conjunction with HIRS/2 to remove measurement ambiguity when clouds are present.
4. *The Space Environment Monitor (SEM)* is a multichannel charged-particle spectrometer that measures the flux density, energy spectrum, and total energy deposition of solar protons, alpha particles, and electrons. These data provide estimates of the energy deposited by solar particles in the upper atmosphere, and a "solar warning system" on the influence of solar fluctuations on the Earth system.
5. *The ARGOS Data Collection System (DCS)* consists of approximately 2,000 platforms (buoys, free-floating balloons, remote weather stations, and even animal collars) that transmit temperature, pressure, and altitude data to the POES satellite. The onboard DCS instrument tracks the frequency and timing of each incoming signal, and retransmits these data to a central processing facility. The system is able to determine transmitter location rather accurately.

Other instruments do not fly on every POES mission. Instruments in this category include:

*The Stratospheric Sounding Unit (SSU)*, a three channel instrument, has flown on all NOAA POES satellites except for NOAA-1 2. It measures the intensity of electromagnetic radiation emitted from carbon dioxide at the top of the atmosphere, providing scientists with the necessary data to estimate temperatures through the stratosphere. The SSU is used in conjunction with HIRS/2 and MSU as part of the TIROS Operational Vertical Sounder System.

*The Solar Backscatter Ultraviolet Radiometer/2 (SBUV/2)* measures concentrations of ozone at various levels in the atmosphere, and total ozone concentration. This is achieved by measuring the spectral radiance of solar ultraviolet radiation "backscattered" from the ozone absorption band in the atmosphere, while also measuring the direct solar spectral irradiance. The SBUV is flown on POES PM orbiters only.

*The Search and Rescue Satellite Aided Tracking System (SARSAT or S&R) kxates* signals from emergency location transponders onboard ships and aircraft in distress, and relays these data to ground receiving stations, which analyze them and transmit information to rescue teams in the area.

The Earth *Radiation Budget Experiment (ERBE)* was flown only on NOAA-9 and NOAA-10. **This research instrument consists of a medium and wide field-of-view non-scanning radiometer, operating in four channels that view the Earth and one channel that views the sun, and a narrow field-of-view scanning radiometer with three channels that scan the Earth from horizon to horizon.** ERBE measures the monthly average radiation budget on regional to global scales, and determines the average daily variations in the radiation budget.

NOAA currently has four POES satellites in orbit. NOAA-11 and NOAA-12, launched in September 1988 and May 1991, respectively, are operational, while NOAA-9 and NOAA-10, launched in 1984 and 1986, are essentially in a stand-by mode. However, the ERBE instrument on NOAA-9 continues to return limited data on the Earth's radiation budget, and the SBUV/2 instrument on NOAA-10 continues to return useful information on ozone concentration in the atmosphere. NOAA plans to upgrade several of the POES instruments in the near future. The SSU and MSU will be replaced with the Advanced Microwave Sounding Units (aboard NOAA K-M), AVHRR **will gain an additional channel, and the ARGOS system will have expanded capacity.** NOAA is planning additional improvements (in the latter part of the 1990s) to AVHRR, HIRS, and AMSU and expects to add a Total Ozone Mapping Spectrometer (TOMS) to the platform.

**NOTE:** The SSU is contributed by the United Kingdom; ARGOS is a contribution of the French Space Agency CNES; and the SARSAT instrument is a joint project of Canada and France.

**SOURCE:** Office of Technology Assessment, 1993.

this service.<sup>8</sup> In return, through the World Meteorological Organization,<sup>9</sup> many of these users provide the United States with local ground-based and radiosonde<sup>10</sup> data, which are essential to understanding large-scale weather patterns and climate. Some countries contribute directly to U.S. programs by supplying satellite instruments. Over the last few years, France has supplied the ARGOS onboard data collection receiver, and, with Canada, the SARSAT location system for the POES satellites; the United Kingdom has supplied the SSU.

Negotiations are currently underway between NOAA, representing the United States, and ESA and Eumetsat for Europe to assume responsibility for morning-crossing operational meteorological

data on the European METOP polar platform. originally, Europe had planned to fly a large polar orbiting platform called POEM (Polar Orbit Earth Observation Mission), planned for launch in 1998. It would have included both research instruments and operational monitoring instruments. However, in order to reduce technical and financial risk, ESA and Eumetsat decided in late 1992 to split up the platform and place the operational and climate monitoring instruments on the Eumetsat METOP platform and the upper atmosphere, ocean, and ice research instruments on the ENVISAT platform.<sup>11</sup> The United States will also fly an improved AVHRR and an Advanced Microwave Sounding Unit (AMSU) on METOP- 1, which is planned for launch in

<sup>8</sup> The reception and analysis of data from these and the GOES satellites have become important instructional tools in schools throughout the world.

<sup>9</sup> See U.S. Congress, Office of Technology Assessment, OTA-ISC-239, *International Cooperation and Competition in Civilian Space Activities* (Washington, DC: U.S. Government Printing Office, 1985), ch. 3.

<sup>10</sup> Instruments carried by satellites or weather balloons that measure and transmit temperature, humidity and pressure data.

<sup>11</sup> The minutes of the ESA Ministerium of November, 1992, state:

- (1) the **Envisat-1** mission planned for launch in 1998, which will be mainly dedicated to understanding and monitoring the environment and to providing radar data as a continuation of the data provided by ERS 2.
- (2) the **Metop-1** mission planned for launch in 2000, which will provide operational meteorological observations to be carried out taking into account the requirements expressed by the Eumetsat Council and in accordance with the terms of an Agreement to be concluded with Eumetsat.

### Box 3-E-DoD's Defense Meteorological Satellite Program

Since the mid 1960s, the Defense Meteorological Satellite Program (DMSP) has provided military commanders with accurate and up-to-date weather information. It began after DoD argued for a satellite to provide reliable and unique weather data in support of U.S. troops involved in exercises or stationed in remote locations that lack other sources of weather information.

Each current DMSP block 5D-2 satellite flies in a polar orbit at an altitude of 632 km (530 miles), and views the entire globe twice per day. The satellites use optical and infrared sensors, which cover a ground swath of just under 3,000 km:

The Operational *Linescan System (OLS)*, a **visible** and infrared imager that monitors cloud cover, has three spectral bands. OLS operates at high spatial resolution (.6km) about 25 percent of the time.

The Microwave Imager (a radiometer used for determining soil moisture, precipitation, and ice cover) has four **channels**, and a spatial resolution of 25-50 km.

The Microwave *Temperature Sounder*, used for vertical temperature sensing, has seven channels.

The Microwave *Water Vapor Sounder*, used for determining humidity through the atmosphere, has five channels and spatial resolution between 40 and 120 km.

The satellites are capable of storing up to 2 days' worth of **data before** downloading to ground stations located at Fairchild AFB, Washington, and Kaena Point, Hawaii. There are currently two of the block 5D-2 satellites in operation, and a new block upgrade is currently in development. The bus, the structural element of the satellite that carries and powers the sensors, is similar to the bus used for the TIROS satellites.

Since 1975, the Navy, Air Force, and NOM have coordinated data processing efforts and exchanged meteorological data through a shared processing network. Each of the processing centers has a particular expertise: NOM for atmospheric soundings; Navy for sea surface measurements and altimetry; and Air Force for visible and infrared mapped imagery and cloud imagery. The focus on each area of expertise is designed to limit duplication and ensure cooperation. NOAA's National Environmental Satellite, Data, and Information Service archives the data processed by all three organizations.

**SOURCE:** U.S. Department of Defense, 1993.

2000. This will reduce U.S. costs of providing data from the second polar orbiter, which is an important first step in saving U.S. costs for the entire polar satellite system. It may also enable the United States and Europe to provide more accurate coverage of weather and climate.

In the early part of the next century, Europe plans to provide nearly half of the polar-orbiter program. NOAA expects the cooperative polar metsat program to lead to nearly identical U.S. and European instruments, spacecraft, instrument interfaces, standard communication procedures, and data transmission standards. This is essential to reduce problems of integrating instruments and to assure that international partners can use each other's data with a minimum of complication.

The program will include some moderate enhancement of instrument capabilities and the addition of a TOMS to maintain the capability to monitor atmospheric ozone.

This cooperative structure should enable the United States and Europe to supply polar orbiter data to the rest of the world. Eventually the two partners might wish to embark on a broader cooperative effort including other countries, which would reduce U.S. and European costs and give greater likelihood to a widely accepted international data standard. For example, Russia operates a polar-orbiting meteorological satellite, Meteor-3, which already carries a TOMS instrument supplied by NOAA. Both the United States and Russia would likely benefit from closer

cooperation on Earth observation satellite systems.

A more broadly based organization, including for example, Russia, China, and India, could also lead to a more capable system of polar orbiters. As noted earlier, the United States and other spacefaring nations have organized the Committee on Earth Observations from Space (CEOS) in order to encourage development of complementary and compatible Earth observation systems (and data), and to address issues of common interest across the spectrum of Earth observation satellite missions.<sup>12</sup> Chapter 8, International Cooperation and Competition, discusses these and other cooperative arrangements in more detail.

## DEFENSE METEOROLOGICAL SATELLITE PROGRAM

DoD maintains an independent meteorological system, the Defense Meteorological Satellite Program (DMSP), managed by the Air Force Space Command (box 3-E). DMSP (figure 3-3) uses a satellite platform very similar to the NOAA POES platform and operates in near-polar orbit, but carries somewhat different instruments. Among other data, DMSP provides visible and infrared ground images, measurements of soil and atmospheric temperature and moisture content, location and intensity of aurora (for radar and communications), and measurements of sea state and wind fields for naval operations. The military also uses three-dimensional cloud data from DMSP in computer models used in operational planning. The phenomena observed by DMSP are similar to those of interest to civilian weather forecasters, but several of the data requirements, such as wind speed at the oceans' surface, are of crucial interest to the military.

Figure 3-3-Artist's Rendition of the Defense Meteorological Satellite, DMSP Block 5D-2

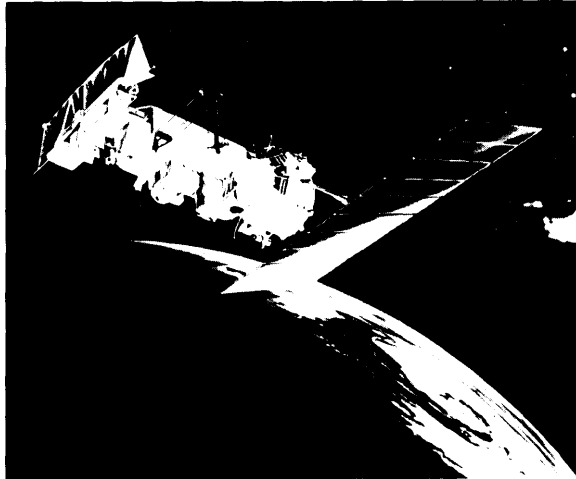

DMSP, operated by the Air Force, gathers meteorological data for military and civilian use. The military services and NOAA operate a joint data center to coordinate data processing and distribution.

SOURCE: U.S. Department of Defense.

Are two polar-orbiting satellite systems required? Critics of the policy of maintaining separate polar-orbiting systems argue that the United States cannot afford both systems.<sup>13</sup> DoD and NOAA counter that each satellite system serves a unique mission. The NOAA satellites routinely provide data to thousands of U.S. and international users. DMSP serves a variety of specialized military needs and provides valuable microwave data to the civilian community. For example, often the United States has troops involved in exercises or stationed in remote locations that would not have other sources of weather information. DoD and NOAA regularly exchange meteorological data. NOAA benefits from DMSP data, and DoD also routinely uses data from NOAA. Yet DoD's needs for both training and operations can be unique. DoD

<sup>12</sup>Committee on Earth Observations Satellites, *The Relevance of Satellite Missions to the Study of the Global Environment*, UNCED Conference, Rio de Janeiro, 1992, p 2.

<sup>13</sup>In 1987 the General Accounting Office released a study arguing that the United States could achieve savings by eliminating duplication of environmental satellite systems. See U. S. Congress, General Accounting Office, NSIAD 87-107, 'U.S. Weather Satellites: Achieving Economies of Scale' (Washington, DC: U.S. Government Printing Office, 1987).

requires a reliable source for global weather forecasting, a function it argues is not duplicated within NOAA. Military analysts fear that civilian satellite systems, which are not under DoD control, would be unable to deliver crucial weather information to their users in time. DoD also wants to have a domestic data source insulated from international politics because data from another country's satellites might not always be made available. Finally, differences in the priorities of instruments result in differing replacement criteria for satellites when an instrument fails. For NOAA the sounder on its POES has the greatest priority. The DMSP imager holds the highest priority for the DoD. For these reasons, DoD claims a distinct need for its own meteorological system.

Congress may wish to revisit the question of **the possible consolidation of DMSP and the NOAA polar orbiting system as it searches for ways to reduce the Federal deficit.** Such a study should include a detailed analysis of the benefits and drawbacks of consolidating civilian and military sensor packages in one system, and the ability of a combined system to serve military needs in time of crisis. It should also look for innovative ways for NOAA and DoD to continue to work in partnership to carry out the missions of both agencies.

## NON-U.S. ENVIRONMENTAL SATELLITE SYSTEMS

### ■ ESA/Eumetsat Meteosat

The first European Meteosat satellite was launched by ESA in 1977. Eumetsat took over overall responsibility for the Meteosat system from ESA in January 1987. The first spacecraft of the Meteosat Operational Programme (MOP-1) was launched in March 1989. MOP-3 is now being prepared for launch in late 1993. It has a

7-year design life. ESA has developed the MOP satellites on behalf of Eumetsat.

The Meteosat/MOP spacecraft design, instrumentation, and operation are similar to the current U.S. NOAA GOES spacecraft. The spin-stabilized spacecraft carry:

1. a visible-infrared radiometer to provide high-quality day/night cloud cover data and to collect radiance temperatures of the Earth's atmosphere; and
2. a meteorological data collection system to disseminate image data to user stations, to collect data from various Earth-based platforms and to relay data from polar-orbiting satellites.

Meteosat spacecraft are in position to survey the whole of Europe, as well as Africa, the Middle East, and the Atlantic Ocean. They relay images and data to a Meteosat Operations Control Centre within ESA'S Space Operations Control Centre in Darmstadt, Germany. A Meteorological Information Extraction Centre, located within the Meteosat control center, distributes the satellite data to various users.

### | Japanese Geostationary Meteorological Satellite

The Japanese space agency, NASDA, developed the Geostationary Meteorological Satellites 1-4, which were launched in 1977, 1981, 1984, and 1989. GMS-5 is projected for a 1995 launch.<sup>14</sup> The GMS satellites are manufactured by Hughes Space and Communications Group and the Japanese corporation NEC, and draw heavily on Hughes' U.S. experiences with GOES. The Japan Meteorological Agency operates the third and fourth satellites, collecting data from the systems' radiometers (visible and infrared sensors), and space environment monitors.

---

<sup>14</sup>GMS-5 is currently in storage at Hughes Space and Communications Group, awaiting an H-II launch vehicle, which is still under development.



### | Commonwealth of Independent States

The former Soviet Union assembled an integrated network of meteorological, land, and ocean sensing systems that have served a wide variety of military and civilian purposes. Now essentially controlled by the Russian Republic, these satellites represent one of the most capable array of remote sensing systems deployed in the world. The CIS operates eight different space platforms (including the Mir space station) that provide remotely sensed data.<sup>15</sup>

The CIS Meteor environmental satellite system consists of two or more polar orbiters, each of

which lasts only a relatively short time in orbit. Each Meteor satellite provides data roughly similar to the NOAA POES satellites. Meteor satellites carry both visible-light and infrared radiometers, and an instrument for monitoring the flux of high energy radiation from space. Data from these instruments lead to information about the global distribution of clouds and snow and ice cover, global radiation temperature of the surface, cloud-top heights, and vertical distribution of temperature. The data can be received around the world by the same APT stations that receive data from the U.S. polar orbiters.

---

<sup>15</sup>See Nicholas L. Johnson, *The Soviet Year in Space* 1990 (Colorado Springs, CO: Teledyne Brown Engineering, 1991), pp. 59-70.

# Surface Remote Sensing | 4

**B**alloons, aircraft, rockets, and spacecraft have all been used successfully to acquire images and other data about Earth's surface. The earliest data were gathered more than 100 years ago by photographic cameras mounted on balloons. The advent of the airplane made possible aerial photography and the accumulation of historic archives of panchromatic (black and white) photographs to document surface features and their changes. Eventually, experimenters discovered that images acquired in several different regions of the electromagnetic spectrum yielded additional valuable information about surface features, including likely mineral or oil and gas-bearing deposits, or the health of crops. The Department of Agriculture, for example, has routinely used infrared photography to monitor the extent of planted fields and the conditions of crops, because, compared to many other surface features, vegetation reflects infrared radiation strongly. Airborne microwave radar has demonstrated its utility for piercing clouds, and for detecting the shape and condition of the soil beneath vegetation.

The ability to transmit images of Earth via radio waves made the use of satellites for remote sensing Earth practical. These images, acquired by electro-optical sensors that convert light to electronic signals,<sup>1</sup> can be transmitted to Earth as the satellite passes over a ground station or they can be stored for later broadcast. Placing remote sensing satellites in a near-polar orbit at an altitude that allows them to pass over the equator at the same

---

<sup>1</sup> A video camera is one example of an instrument that employs an electro-optical sensor.

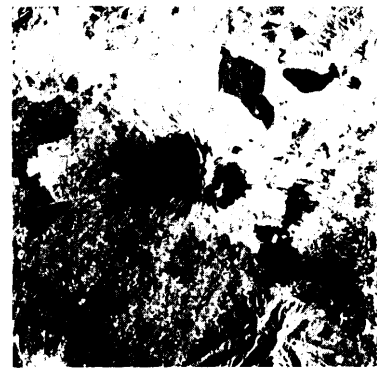

time each day makes it possible to collect images of Earth's surface with nearly the same viewing conditions from day to day,<sup>2</sup> enabling users of the data easily to compare images acquired on different days. Multispectral sensors enable users to acquire data on surface spectral characteristics. Other, non-polar orbits can be selected to maximize the accumulation of data over certain latitudes. For example, scientists who designed TOPEX/Poseidon, a scientific satellite designed to collect topographic data on the oceans, chose a mid-latitude orbit, optimizing the orbit to travel above the world's oceans, and allowing the satellite to monitor the effects of tidal changes on ocean topography.

## THE LANDSAT PROGRAM

NASA initiated the Landsat program in the late 1960s as an experimental research program to investigate the utility of acquiring multispectral, moderate resolution data about Earth's surface (plate 4). Since then the Landsat system has evolved into a technically successful system that routinely supplies data of 30 meter (m) ground resolution in six spectral bands<sup>3</sup> to users around the world (box 4-A). A wide variety of government agencies at the local, State, and Federal levels, academia, and industry make use of Landsat data.

From a programmatic standpoint, however, the Landsat program has proved much less successful and has several times teetered on the brink of extinction. As the experience of the past decade has demonstrated, the utility of these data for serving both public and private needs has made it difficult to arrive at policies for support of

Landsat that satisfy all interests well. After an 8-year trial, Congress and other observers have concluded that the experiment to commercialize the Landsat system has met with only limited success.<sup>4</sup>

## | Landsat 7

As noted earlier, continuity in the delivery of remotely sensed data, in many cases, is critical to their effective use. Many Landsat data users have long warned that a loss of continuity in the delivery of data from the Landsat satellites would severely threaten their usefulness. Timely and continuous data delivery are important for global change research, but apply equally well to other projects, including those designed to use Landsat data for managing natural resources in regions that lack other sources of data, or for urban planning. Landsat data are extremely important for detecting change in the conditions of forests, range, and croplands over local, regional, and global scales. They can also be used for monitoring changes in hydrologic patterns. Hence, continuity in the delivery of data from Landsat is an important component of environmental research and monitoring.

In 1992, agreeing that maintenance of data continuity was of crucial importance, members of the House and Senate introduced legislation (H.R. 3614 and S. 2297) to establish a new land remote sensing policy. The Land Remote Sensing Policy Act of 1992<sup>5</sup> transfers control of Landsat from the Department of Commerce to DoD and NASA, to be managed jointly. According to the Administration Landsat Management Plan, DoD has responsibility for procuring Landsat 7, planned

<sup>2</sup>The sun's angle with respect to the surface varies somewhat throughout the year, depending on the sun's apparent position with respect to the equator.

<sup>3</sup>Band 6, the thermal band, senses data at a resolution of 120 meters.

<sup>4</sup>See U.S. Congress, Office of Technology Assessment *Remotely Sensed Data From Space: Distribution, Pricing, and Applications* (Washington DC: Office of Technology Assessment July 1992), pp. 3-4. U.S. House of Representatives, report to accompany H.R. 3614, the Land Remote Sensing Policy Act of 1992, May 1992.

<sup>5</sup>H.R. 3614 was passed by the House on June 9, 1992. After lengthy debate, differences between the two bills were resolved in H.R. 6613, which was passed by the House in late September and by the Senate in early October. The Act was signed by President Bush on Oct. 29, 1992.

### Box 4-A—The Landsat Program

The United States initiated the Landsat program in 1969 as a research activity. NASA launched Landsat 1 in 1972.<sup>1</sup> Data from the Landsat system soon proved capable of serving a wide variety of government and private sector needs for spatial information about the land surface and coastal areas. NASA designed, built, and operated Landsats 1-3. The perceived potential economic value of Landsat imagery led the Carter administration to consider commercial operation of the system and begin transferring control of Landsat operations and data distribution from NASA to the private sector. The first step in the transition gave operational control of the Landsat system to NOAA in 1981, because of NOAA's extensive experience in operating remote sensing satellites for weather and climate observations. Landsat 4 was launched in 1982; Landsat 5<sup>2</sup> became operational in 1984.<sup>3</sup>

In late 1983, the Reagan administration took steps to speed transfer operation of Landsat 4 and 5 to private hands because it did not want to continue public funding for the system. A few proponents of commercialization expected **that industry could soon build a sufficient data market to support a land remote sensing system.** **Soon thereafter**, Congress began consideration of the Land Remote Sensing Commercialization Act of 1984, which was intended to provide legislative authority for the transfer process. Public Law 98-365 was signed into law on July 17, 1984. During deliberations over the Landsat Act, the administration issued a request for proposal (RFP) for industry to operate Landsat and any follow-on satellite system. After competitive bidding,<sup>4</sup> NOAA transferred control of operations and marketing of data to EOSAT in 1985.<sup>5</sup> At present, EOSAT operates Landsats 4 and 5 under contract to the Department of Commerce,<sup>7</sup> and manages distribution and sales of data from Landsats 1-5. EOSAT will operate Landsat 6, **which is scheduled for launch** in the summer of 1993. The U.S. Government has paid for the Landsat 6 satellite and the launch. EOSAT will operate the satellite at its expense.

Because of concerns over continuity of data collection and delivery, Congress passed the Land Remote Sensing Policy Act of 1992, which transfers control of the Landsat program from NOAA to DoD and NASA. This legislation effectively ends the experiment to privatize the Landsat program. The two agencies will procure and operate Landsat 7.

<sup>1</sup>Initially called the Earth Resources Technology Satellite, NASA retroactively changed its name in 1975.

<sup>2</sup>Landsats 4 and 5 were designed by NASA and built by GE and Hughes Santa Barbara Research Center.

<sup>3</sup> See U.S. Congress, Congressional Research Service, *The Future of Land Remote Sensing Satellite System (Landsat)*, 91-685 SPR (Washington, DC: The Library of Congress, Sept. 16, 1991) for a more complete account of the institutional history of Landsat.

<sup>4</sup> However, most analysts were extremely pessimistic about such prospects. See U.S. Congress, congressional Budget Office, *Encouraging Private Investment in Space Activities* (Washington, DC: U.S. Government Printing Office, February 1991), oh. 3.

<sup>5</sup> Seven firms responded to the RFP, from which two were selected for further negotiations—EOSAT and Kodak/Fairchild. After a series of negotiations, during which the government changed the ground rules of the RFP, Kodak dropped out, leaving EOSAT to negotiate with the Department of Commerce.

<sup>6</sup> EOSAT was established as a joint venture by RCA (now part of Martin Marietta Astrospac) and Hughes Space and Communications Group (now part of General Motors) for this purpose.

<sup>7</sup> Subsystems in both satellites have failed, but together they function as a nearly complete satellite system. EOSAT has taken great care to nurse these two satellites along, in order to maintain continuity of data delivery until Landsat 6 is operational.

SOURCE: U.S. Congress, Office of Technology Assessment, *Remotely Sensed Data from Space: Distribution, Pricing, and Applications* (Washington, DC: Office of Technology Assessment, July 1992), pp. 2-3.

Figure 4-1-Landsat 6 Satellite, Showing the Enhanced Thematic Mapper (ETM)

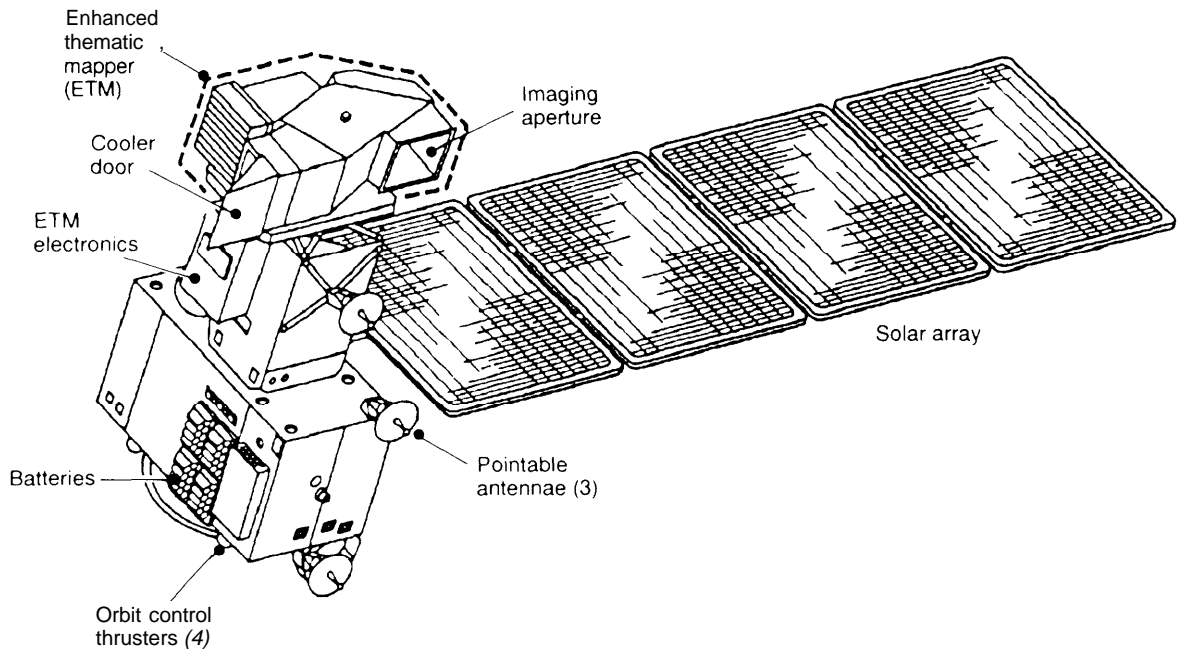

SOURCE: EOSAT, 1993.

for launch in late 1997. NASA will manage operation of Landsat 7 and supervise data sales.<sup>6</sup> The agencies will cooperate in developing specifications for possible future Landsat systems and in developing new sensors and satellite technology.

Because data continuity is important to many users, program managers specified that Landsat 7 should at a minimum duplicate the format and other characteristics of data from Landsat 6. Landsat 7 will therefore carry an Enhanced Thematic Mapper (ETM) sensor very similar to the one on Landsat 6 (figure 4- 1). NASA and DoD are currently designing an additional sensor for Landsat, called the High Resolution Multispectral Stereo Imager (HRMSI). If funded, HRMSI would greatly improve the ability of Landsat 7 to gather data about Earth's surface. As currently envisioned, HRMSI would have much higher surface resolution than the ETM (5 m black and

white; 10 m in four visible and infrared bands), and would be capable of acquiring stereo images.<sup>7</sup> Combined, these capabilities would allow the Defense Mapping Agency and the U.S. Geological Survey, among others, to use Landsat data in creating multispectral topographic maps. In addition, HRMSI would have the ability to acquire data on either side of its surface track, allowing the instrument to improve its revisit time from Landsat's current 16 days to only 3 days. This capability would markedly increase the utility of Landsat data for a variety of applications, such as detection of military targets and agricultural monitoring, where timeliness is an important factor. **If Congress wishes to improve the ability of U.S. agencies to use remotely sensed data in carrying out their legislatively mandated missions, it may wish to fund HRMSI or a sensor with similar capabilities.**

<sup>6</sup>A commercial entity may well be chosen to market Landsat data.

<sup>7</sup>Stereo images make possible the creation of topographic maps.

NASA and DoD estimate that procuring and operating Landsat 7 with only the ETM sensor through the end of its planned 5-year lifetime will cost about \$880 million (in 1992 dollars)--\$410 from NASA and \$470 from DoD. About \$398 million will be needed in the first few years to purchase the satellite with the ETM. An additional \$403 million will be needed between 1994 and the projected end of Landsat 7's useful life to purchase the HRMSI, enhance the ground system to handle the increased data flow,<sup>8</sup> and operate the satellite. General Electric Corp. and Hughes Santa Barbara Research Center, which built Landsat 6 (table 4-1), were awarded the contract to build Landsat 7 (table 4-2).<sup>9</sup>

### | Future Landsat Satellites

Planning for a system to replace Landsat 7 after it lives out its useful life is in the very early stages. **Higher spatial resolution, a greater number of spectral bands, and improved sensor calibration are among the most important improvements sought for future Landsat satellites. However, timeliness of data delivery after data acquisition and the revisit time of the satellite<sup>10</sup> also need improvement, especially for monitoring short-term changes such as occur in crop and other renewable resource production.**

If Landsat 7 proceeds as planned, scientists will be able to experiment with the use of high-resolution, stereo images in evaluating ecological change. However, the limited number of spectral bands provided by Landsat 7 may inhibit detailed ecological modeling of land processes. Given the importance of remotely sensed land

**Table 4-1—Technical Characteristics of Landsat 6**

---

**Orbit and coverage:**

**LandSat 6 will follow an orbit similar to that of Landsats 4 and 5:**

*Orbit Altitude: 705 kilometers*

**Type: Circular, sun synchronous, one orbit every 98.9 minutes (about 14.5 per day)**

*Equatorial crossing time: 9:45 am*

**Repeat coverage at Equator 16 days**

*Inclination: 98.21*

**Sensor package:**

**Landsat 6 will carry a Thematic Mapper Sensor similar to Landsats 4 and 5, but with improved calibration, and an additional, higher resolution black and white (panchromatic) band.**

*Enhanced Thematic Mapper characteristics:*

- **Panchromatic band, 15 meter ground resolution**
  - **Six (visible-infrared) multispectral bands, 30 meters resolution**
  - **One thermal infrared band, 120 meters.**
- 

**SOURCE:** Earth Observation Satellite Co., 1992.

data to global change research (see chs. 5 and 6), NASA may wish to consider the potential for incorporating some of the enhanced spectral capabilities of the proposed High Resolution Imaging Spectrometer (HIRIS)<sup>11</sup> into the design for a follow-on to Landsat 7. HIRIS designers have dealt with many of the design and operational issues associated with hyperspectral capabilities and could significantly improve the design of a successor to Landsat 7.

Recent technological developments, in, for example, focal plane technology and active cryocoolers, suggest that it may be possible to design, build, and operate a Landsat 8 that would be much more capable than Land sat 7. The Land Remote Sensing Policy Act of 1992 calls for a technology development program to fund new sensors and

---

<sup>8</sup> With the HRMSI sensor, Landsat 7 would have a maximum data transfer rate from the satellite to the ground station of about 300 megabytes per second.

<sup>9</sup> Martin Marietta Astrospac, which recently purchased GE Astrospac, is now the prime contractor. Hughes Santa Barbara Research Center built the ETM for Landsat 6, will construct the ETM for Landsat 7. It would also develop HRMSI for Landsat 7. Although several aerospace corporations expressed interest, this team was the only bidder, in part because other companies felt they would not be competitive with the team that had built Landsat 6.

<sup>10</sup> Perhaps by doubling the number of satellites in orbit.

<sup>11</sup> A high-resolution sensor that had been proposed for the EOS program, but recently canceled. See ch. 5: Global Change Research.

**Table 4-2—Technical Characteristics of Landsat 7**

Compared to Landsat 6, Landsat 7 will have:

1. *Improved spatial resolution*-a new sensor with 5 meters resolution in the panchromatic band and 10 meters in 4 visible and near infrared bands.
2. *Improved Absolute Radiometric Calibration*-An Enhanced Thematic Mapper Plus will have improved calibration of the sensor to allow for gathering improved science data and improved long-term radiometric stability of the sensors.
3. *Stereo mapping capability*-The 5 meter sensor will collect stereo image pairs along the satellite track with a ground sample distance of 5 meters and a vertical relative accuracy of 13 meters.
4. *Cross-track pointing*-The contractor team will provide the ability to point to locations on either side of the satellite's ground track in order to revisit areas imaged on earlier passes. With a 16-day revisit time, Landsats 4,5, and 6 are not able to provide timely data on surface changes that occur in time periods less than 16 days, such as during critical growing periods in the spring.
5. *Improved radiometric sensitivity*-Improvements in the range of light intensity over which the Landsat sensors can accurately sense reflected or emitted light.
6. *Improved satellite position accuracy*-Mapping applications will be much improved by knowing more accurately the spacecraft's position and attitude in orbit at all times. Landsat 7 will carry a GPS receiver to enable improved position data.

SOURCE: National Aeronautics and Space Administration, 1993.

spacecraft for future land remote sensing satellites.<sup>12</sup> New technologies introduce a significant element of technological and cost risk. **If Congress wishes to reduce these risks for a future Landsat system, Congress could provide DoD and NASA sufficient funds to support a technology development and testing program for advanced Landsat technology.**

Satellite and sensor designers have suggested a number of improvements for land remote sensing satellites, including some focused on reducing satellite size and weight. However, proving new concepts will require extensive design review and technology development. In addition, constructing a satellite system that is

**expected** to last 5 or more years without significant degradation requires extensive testing at both the component and system level.

Developing new sensors for programs that have requirements for returning data on a long term, operational basis presents a special challenge to spacecraft designers because these instruments must meet more stringent specifications than those for short-term research missions. Hence, progress in sensor and spacecraft design tends to be incremental, rather than revolutionary. Satellite system experts estimate that the development of a new satellite system for Landsat 8, beginning with concept development and **proceeding through detailed design and construction, could take as long as 8 years. Hence, if Congress wants to increase the chances of maintaining continuity of Landsat data delivery after Landsat 7, it should direct DoD and NASA to start planning in 1993 to specify the design of Landsat 8.**

## NON-US. LAND REMOTE SENSING SYSTEMS

Other countries have developed and flown very capable land remote sensing satellites.<sup>13</sup> The following section summarizes the capabilities of these systems.

### | France

#### SYSTEME POUR D'OBSERVATION DE LA TERRE (SPOT)

The SPOT-2 satellite, which was designed, built, and is operated by Centre Nationale d'Etudes Spatial (CNES), is the second in a series of SPOT satellites. It achieves a higher spatial resolution than Landsat 6, but has fewer spectral bands. It is capable of acquiring panchromatic data of 10 m resolution, and 20 m resolution data in 3 spectral bands. SPOT's off-nadir viewing yields stereoscopic pairs of images of a given area

<sup>12</sup>Public Law 102-555, Title III; 106 STAT. 4174; 15 USC 5631-33.

<sup>13</sup>See app. D for more detail on these systems.

by making successive satellite passes. A standard SPOT scene covers an area 60 x 60 kilometers (km). CNES expects to launch SPOT 3 in late 1993.

CNES developed SPOT with the intention of selling data commercially and attempting to develop a self-sustaining enterprise. SPOT Image, S. A., the French company formed to market SPOT data to a global market, is a major competitor to EOSAT in selling remotely sensed land data. Although SPOT Image has been successful in increasing its yearly sales each year, and now makes a modest profit on SPOT operations, it still does not earn sufficient income to support the construction and launch of replacement satellites. The French Government, through CNES, is expected to continue to provide additional satellites through the end of the decade.

During the 1992 and 1993 growing seasons, CNES reactivated SPOT-1 in order to provide more timely coverage of agricultural conditions. Key to the French strategy in building a market for remote sensing data is the CNES plan to assure continuity of data delivery and a series of evolutionary upgrades to the SPOT system. By the end of the century, CNES plans to add the capability of gathering 5 m resolution, panchromatic stereo data. It also plans to add an infrared band to enhance the data's usefulness in agriculture and other applications. The new data policy for Landsat 7 under which "unenhanced data are available to all users at the cost of fulfilling user requests"<sup>14</sup> may pose a problem for SPOT Image, as Landsat data would be sold to private sector users for much less than the current prices. OTA will examine these and other data issues in a future report on remotely sensed data.

## | India

### INDIAN REMOTE SENSING SATELLITE (IRS)

As India's first domestic dedicated Earth resources satellite program, the IRS-series provides

continuous coverage of the country. An indigenous ground system network handles data reception, data processing, and data dissemination. India's National Natural Resources Management System (NNRMS) uses IRS data to support a large number of applications projects.

India has orbited two IRS satellites: IRS-1A was launched in March 1988 by a Russian booster; IRS-1B reached space in August 1991, also launched by a Russian vehicle. Each carries two payloads employing Linear Imaging Self-scanning Sensors (LISS). The IRS-series have a 22-day repeat cycle. The LISS-I imaging sensor system consists of a camera operating in four spectral bands, compatible with the output from Landsat-series Thematic Mapper and SPOT HRV instruments. The LISS-IIA & B is comprised of two cameras operating in visible and near infrared wavelengths with a ground resolution of 36.5 m, and swath width of 74.25 km.

As part of the National Remote Sensing Agency's international services, IRS data are available to all countries within the coverage zone of the Indian ground station located at Hyderabad. These countries can purchase the raw/processed data directly from NRSA Data Centre.

India is designing second generation IRS-1C and ID satellites that will incorporate sensors with resolutions of about 20 m in multispectral bands and better than 10 m in the panchromatic band. System designers intend to include a short-wave infrared band with spatial resolution of 70 m. The system will also include a Wide Field Sensor (WiFS) with 180 m spatial resolution and larger swath of about 770 km for monitoring vegetation.

## | Japan

### JAPAN EARTH RESOURCES SATELLITE (JERS-1)

A joint project of the Science and Technology Agency, NASDA, and the Ministry of International Trade and Industry (MITI), JERS-1 was

<sup>14</sup>PublicLaw102-55;106 STAT 4170; 15 USC 5615.



launched by a Japanese H-1 rocket in February 1992. Observations from JERS-1 focus on land use, agriculture, forestry, fishery, environmental preservation, disaster prevention, and coastal zone monitoring. It carries a synthetic aperture radar and an optical multispectral radiometer.

JERS-1 data are received at NASDA'S Earth Observation Center, Saitama, and at the University in Kumamoto Prefecture, the Showa Base in the Antarctica, and the Thailand Marine Observation Satellite station. Under a NASDA-NASA Memorandum of Understanding, the NASA-funded SAR station in Fairbanks, Alaska, also receives JERS-1 data. These data overlap the SAR data from the European ERS-1 mission, and the future Canadian Radarsat mission, planned for launch in 1994.

Japan also operates the Marine Observation Satellite (MOS 1b) system that collects data about the land as well as the ocean surface. See below for description.

### | Russia

#### RESURS-O

The Resurs-O digital Earth resources satellites are roughly comparable to the U.S. Landsat system and are derived from the Meteor series of polar orbiters. They carry multiple multispectral instruments operating in the visible to thermal infrared. Remote sensing instruments aboard a Resurs-O comprise two 3-band scanners, providing 45 m resolution. A second 5-band scanner senses a 600 km swath at 240 m X 170 m resolution. A 4-band microwave radiometer views a 1,200 km swath at 17 to 90 km resolution. In addition a side-looking synthetic aperture radar provides 100 km coverage at 200 m resolution. The Resurs-O spacecraft can process some data in orbit and relay data directly to ground stations.

Russian scientists are planning a follow-on to this series, which would carry high-resolution optical sensors capable of 15 to 20 m resolution.

They have explored the possibility of establishing commercial Resurs-O receiving stations in Sweden, as well as the United Kingdom.

#### RESURS-F

This class of photographic satellite mimics Russian military reconnaissance spacecraft by using a film return capsule, which is deorbited and brought to Earth under parachute. Resurs-F1 and Resurs-F2 spacecraft use the Vostok reentry sphere, earlier used for launching cosmonauts. The Resurs-F1 typically flies at 250km to 400km altitude for a 2-week period and carries a three-channel multispectral system that includes three KATE-200 cameras and two KFA-1000 cameras. The KATE--200 camera provides for Earth survey in three spectral bands. It can collect stereoscopic imagery having an along-track overlap of 20, 60, or 80 percent.<sup>15</sup> Resolution of the images, according to spectral band and survey altitude, varies from 10 to 30 m over a 180 km swath width. The KFA-1000 cameras provide stereo images of up to 5 m resolution with a 60 km swath width.

The Resurs-F2 spacecraft normally circuit Earth for as long as 3 to 4 weeks in a variable orbit of 259 to 277 km. Onboard is the MK-4 camera system, which can survey the Earth using a set of four cameras in six spectral channels. Also, 5 to 8 m resolution stereo is possible with a swath width of 120 to 270 km. Imagery provided by Resurs-F1 and F2 spacecraft are being offered commercially through Sojuzkarta.

### OCEAN SENSING AND THE ICE CAPS

Because the oceans cover about 70 percent of Earth's surface, they make a significant contribution to Earth's weather and climate. The oceans interact constantly with the atmosphere above them and the land and ice that bound them. Yet scientists know far too little about the details of the oceans' effects on weather and climate, in part because the oceans are monitored only coarsely by ships and buoys. Improving the safety of

---

<sup>15</sup> Reliable stereo requires at least 60 percent overlap.

people at sea and managing the seas' vast natural resources also depend on receiving better and more timely data on ocean phenomena, Satellite remote sensing is one of the principal means of gathering data about the oceans.

### | Research on Ocean Phenomena

In order to understand the behavior of the oceans and to make more accurate predictions of their future behavior, scientists need to gather data about sea temperature, surface color, wave height, the distribution of wave patterns, surface winds, surface topography, and currents. Fluctuations in ocean temperatures and currents lead to fluctuations in the atmosphere and therefore play a major part in determining weather and climate. For example, El Nino, the midwinter appearance of warm water off the coast of South America every 4 to 10 years, decreases the nutrients in the coastal waters off South America, and therefore the number of fish. However, in 1988, El Nino had a major effect on weather patterns over North America. The warm water was pushed further north than usual, which created severe storms hundreds of miles to the north and shifted the jet stream further north. This blocked the Canadian storm systems, which normally send cool air and moisture south during the summer, and led to an unusual amount of dry, hot weather, precipitating severe drought in the central and eastern United States.<sup>16</sup> The drought, in turn, severely affected U.S. agriculture. The winter 1992-1993 El Nino condition had a major role in producing extremely high levels of rain and snow in the western United States during February 1993. Understanding and predicting these interactions are major goals of climatologists.

The study of other ocean phenomena would enhance scientists' understanding of the structure and dynamics of the ocean. For example, observations of wave conditions are important for model-

ing ocean dynamics. Because winds create waves, measurements of wind speed and direction over wide areas can lead to estimates of wave height and condition.

Closely observing the color of the ocean surface provides a powerful means of determining ocean productivity. Variations in ocean color are determined primarily by variations in the concentrations of algae and phytoplankton, which are the basis of the marine food chain. Because these microscopic plants absorb blue and red light more readily than green light, regions of high phytoplankton concentration appear greener than those with low concentration. Because fish feed on the phytoplankton, regions of high concentration indicate the possibility of greater fish population.

Interest in using satellites to measure ocean phenomena began in the 1960s. In 1978, the polar-orbiting TIROS satellites began to gather data on sea surface temperatures using the AVHRR (plate 5) and microwave sensors. The maps of sea surface temperatures produced from these data demonstrate complex surface temperature patterns that have led to considerable speculation about the physical processes that might cause such patterns. However, it was not until NASA launched Nimbus 7 and Seasat in 1978 that scientists were able to gather comprehensive measurements of the oceans. Nimbus-7 carried a Scanning Multichannel Microwave Radiometer (SMMR) that provided accurate measurements of sea surface temperatures. By measuring the color of the ocean surface, its Coastal Zone Color Seamer (CZCS) provided estimates of ocean biological productivity.

Seasat<sup>17</sup> carried five major instruments-an altimeter, a microwave radiometer, a scatterometer, a visible and infrared radiometer, and a synthetic aperture radar. Scientists used data from these instruments to measure the amplitude and direction of surface winds, absolute and relative

<sup>16</sup>D. James Baker, *Planet Earth: The View from Space* (Cambridge, MA: Harvard University Press, 1990), pp. 2-3.

<sup>17</sup>U.S. Congress, Mice of Technology Assessment, *Technology and Oceanography*, OTA-O-141 (Washington, D. C.: U.S. Government Printing Office, 1981).

**surface** temperature, the status of ocean features such as islands, shoals, and currents, and the extent and structure of sea ice. Although Seasat operated only 3 months, it returned data of considerable value to ocean scientists and paved the way for the current generation of U.S. and foreign ocean instruments and satellite systems.

### | Operational Uses of Ocean Satellites

The development and operation of Seasat demonstrated the utility of continuous ocean observations, not only for scientific use, but also for those concerned with navigating the world's oceans and exploiting ocean resources. Its success convinced many that an operational ocean remote sensing satellite would provide significant benefits.<sup>18</sup> The SAR,<sup>19</sup> the scatterometer, and the altimeter all gathered data of considerable utility. Not only do DoD and NOAA have applications for these sensors in an operational mode (i.e., where continuity of data over time is assured and the data formats change only slowly), but so also do private shipping firms and operators of ocean platforms. Knowledge of currents, wind speeds, wave heights, and general wave conditions at a variety of ocean locations is crucial for enhancing the safety of ships at sea, and for ocean platforms. Such data could also decrease costs by allowing ship owners to predict the shortest, safest sea routes.

Over the past decade, the U.S. Government has made two major attempts to develop and fly a dedicated operational ocean satellite carrying sensors similar to those on Seasat. Both attempts failed when the programs were canceled for lack of funding. In 1982, the United States canceled a joint DoD/NOAA/NASA program to develop the National Oceanic Satellite System (NOSS), and

in 1988 it canceled a similar satellite that the Navy was attempting to develop, the Navy Remote Ocean Sensing Satellite (N-ROSS). TOPEX/Poseidon, a research satellite, was launched in 1992 for altimetry studies.

Data from the SeaWiFS instrument aboard the privately developed SeaStar satellite, will provide ocean color information, which could have considerable operational use.<sup>20</sup> Although NASA's EOS will include ocean sensors to support research on issues concerning the oceans and ocean-atmospheric interactions, no instruments devoted to operational uses are planned.

### | Observations of Sea Ice

Because sea ice covers about 13 percent of the world's oceans, it has a marked effect on weather and climate. Thus, measurements of its thickness, extent, and composition help scientists understand and predict changes in weather and climate. Until satellite measurements were available, the difficulties of tracking these characteristics were a major impediment to understanding the behavior of sea ice, especially its seasonal and yearly variations.

The AVHRR visible and infrared sensors aboard the NOAA POES have been used to follow the large-scale variations in the Arctic and Antarctic ice packs. Because they can "see through" clouds, synthetic aperture radar instruments are particularly useful in tracking the development and movement of ice packs, which pose threats to shipping, and in finding routes through the ice. Data from ERS-1, Almaz, and JERS-1 (see below) have all been studied to understand their potential for understanding sea ice and its changes. The Canadian Radarsat will be devoted in part to gathering data on the ice

---

<sup>18</sup> Donald Montgomery, "Commercial Applications of Satellite Oceanography," *Oceanus* 24, No. 3, 1981; Joint Oceanographic Institutions, "Oceanography From Space: A Research Strategy for the Decade 1985 -1995," report (Washington, DC: Joint Oceanographic Institutions, 1984).

<sup>19</sup> See appendix B, box B-3, for a description of how synthetic aperture radar operates.

<sup>20</sup> See below for a summary description of SeaStar. See ch. 7 for discussion of the financial arrangements that have made its development possible.

packs to aid shippers, fishing fleets, and other users of the northern oceans. NASA is providing a receiving station in Alaska to collect Radarsat data and make them available to U.S. researchers.

## MAJOR EXISTING OR PLANNED OCEAN AND ICE REMOTE SENSING SATELLITES

The separation of satellites into those that view the land or the ocean is highly artificial because instruments used for land features often reveal information about the oceans and vice versa. In addition, because most instruments specifically designed either for land or ocean features can fly on the same satellite, such separations are not required for operational use. Nevertheless, as a result of the division of disciplines and the desire of funding agencies to group instruments designed primarily for investigating land or ocean features on the same satellite bus, satellites generally fall into one category or the other.

### | Canada

#### RADARSAT

This satellite, to be launched in 1995 aboard a Delta II launcher, will carry a C-band synthetic aperture radar capable of operating in several different modes and achieving resolutions from 10 to 50 m, depending on the swath width desired. It is designed to gather data for:

1. ice mapping and ship navigation;
2. resource exploration and management;
3. high arctic surveillance;
4. geological exploration;
5. monitoring of crop type and health;
6. forestry management;
7. Antarctic ice mapping.

The satellite will have a repeat cycle of 1 day in the high Arctic, 3 days over Canada, and 24 days over the equatorial regions. The Canadian firm, Radarsat International, will market data collected from the Radarsat system. It will offer contracts to stations around the world that are

collecting SPOT and/or Landsat data, enabling them to collect and market Radarsat data.

### | European Space Agency

#### EARTH RESOURCES SATELLITE (ERS-1)

The ERS-1 satellite was launched into polar orbit by an Ariane booster in July 1991 and was declared operational 6 months later. Operating from a Sun-synchronous, near-polar orbit, ERS-1 is the largest and most complex of ESA'S Earth observation satellites. It carries several instruments:

1. Along Track Scanning Radiometer and Microwave Sounder, which makes infrared measurements to determine, among other parameters, sea surface temperature, cloud top temperature, sea state, and total water content of the atmosphere.
2. Radar Altimeter, which can function in one of two modes (ocean or ice) and provides data on significant wave height; surface wind speed; sea surface elevation, which relates to ocean currents, the surface geoid and tides; and various parameters over sea ice and ice sheets.
3. Synthetic Aperture radar to study the relationships between the oceans, ice, land, and the atmosphere. The SAR'S all-weather, day-and-night sensing abilities is critical for polar areas that are frequently obscured by clouds, fog, and long periods of darkness.
4. Wind Scatterometer to measure surface winds. By measuring the radar backscatter from the same sea surface, picked up by the three antennas placed at different angles, wind speed and direction can be determined.

The primary objectives of the ERS-1 mission focus on improving understanding of oceans/atmosphere interactions in climatic models; advancing the knowledge of ocean circulation and transfer of energy; providing more reliable estimates of the mass balance of the Arctic and

Antarctic ice sheets; enhancing the monitoring of pollution and dynamic coastal processes (plate 6); and improving the detection and management of land use change.

More specifically, data from ERS-1 are being used to study ocean circulation, global wind/wave relationships; monitor ice and iceberg distribution; determine more accurately the ocean geoid; assist in short and medium-term weather forecasting, including the determination of wind speed and direction, as well as help locate pelagic fish by monitoring ocean temperature fronts. Data from the spacecraft also contribute to the international World Climate Research Program and to the World Ocean Circulation Experiment.

## | Japan

### MARINE OBSERVATION SATELLITE (MOS)

The MOS-1 was Japan's first Earth observation satellite developed domestically. The first MOS-1 was launched in February 1987 from Tanegashima Space Center by an N-II rocket. Its successor, MOS - 1b, with the same performance as MOS-1, was launched by an H-I rocket in February 1990. These spacecraft orbit in sun-synchronous orbits of approximately 909 km and have a 17-day recurrent period, circling the Earth approximately 14 times a day. The two spacecraft can be operated in a simultaneous and/or independent mode.

MOS-1 and MOS-1b are dedicated to the following objectives:

- establishment of fundamental technology for Earth observation satellites;
- experimental observation of the Earth, in particular the oceans, monitoring water turbidity of coastal areas, red tide, ice distribution; development of observation sensors; verification of their functions and performance; and

. basic experiments using the MOS data collection system.

Each of the spacecraft carry three sensors: a Multispectral Electronic Self-scanning Radiometer (MESSR); a Visible and Thermal Infrared Radiometer (VTIR); and a Microwave Scanning Radiometer (MSR). MOS products are available for a fee from the Remote Sensing Technology Center of Japan (RESTEC).

## | U.S./French

### TOPEX/POSEIDON

TOPEX/Poseidon is a research satellite devoted primarily to highly accurate measurements (to an accuracy of about 2 cm) of the height of the oceans. The satellite, which was launched in September 1992 by the European Ariane launcher, also carries a microwave radiometer in order to correct for the effects of water vapor in the atmosphere. France supplied a solid-state altimeter and a radiometric tracking system. The satellite's orbit allows determination of ocean topography from latitudes 63° north to 63° south. The height of the ocean is crucial to understanding patterns of ocean circulation. Accurate altitude measurements could lead to better understanding of ocean topography and dynamics, tides, sea ice position, climate, and seafloor topography, among other ocean-related qualities.<sup>21</sup> Data from TOPEX/Poseidon are distributed to scientists in the United States, France, and other countries in accordance with data policies agreed on between NASA, CNES and other members of CEOS.

## | Orbital Sciences Corp.

### SEASTAR/SEAWIFS

The Orbital Sciences Corp. (OSC) is constructing the SeaStar satellite, which will carry the Sea-viewing Wide Field of view Sensor (SeaWiFS), an 8-band multispectral imager oper-

<sup>21</sup>"Satellite Altimetric Measurements of the Ocean," report of the TOPEX Science Working Group, NASA, JPL 1981; Richard Fifield, "The Shape of Earth from Space," *New Scientist*, Nov. 15, 1984, pp. 46-50.

Figure 4-2—The Orbital Sciences Corporation's SeaStar Ocean Color Satellite System

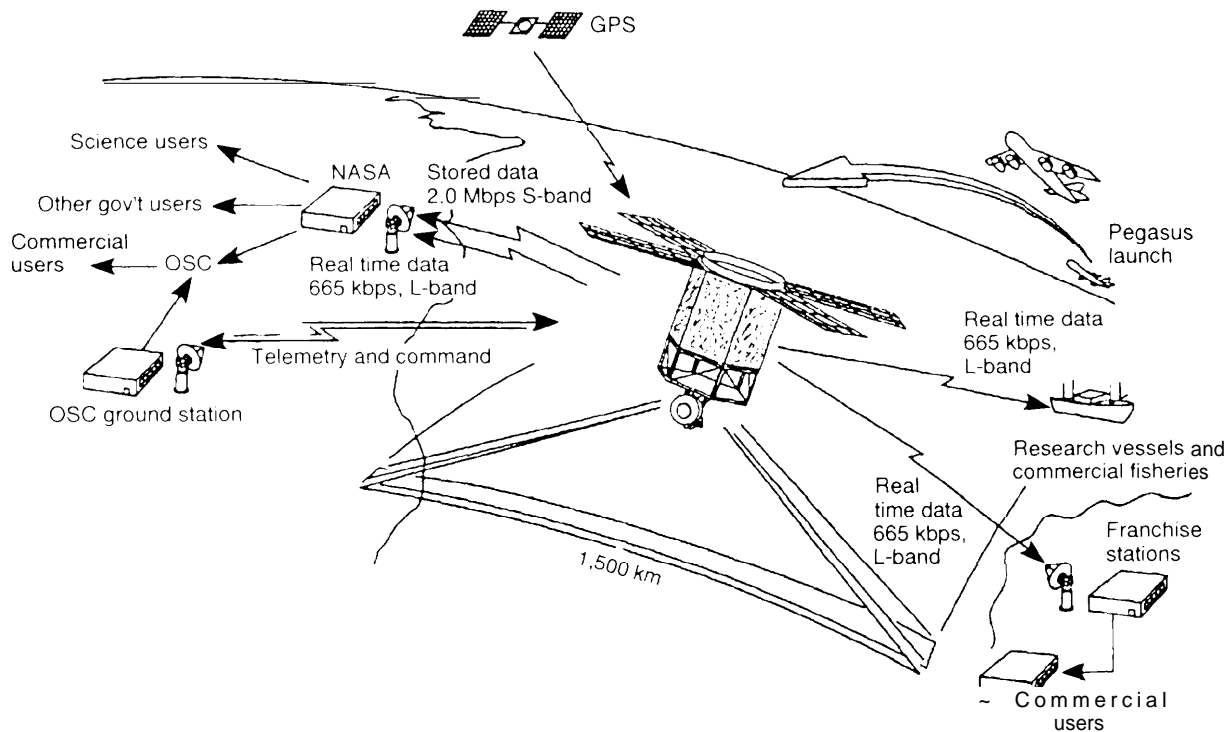

SOURCE: Orbital Sciences Corp., 1992.

ating in the very near infrared portion of the spectrum.<sup>22</sup> SeaWiFS, which OSC plans to launch in late 1993, will be used to observe chlorophyll, dissolved organic matter, and pigment concentrations in the ocean. The sensor will contribute to monitoring and understanding the health of the ocean and concentration of life forms in the ocean. Data will have significant commercial potential for fishing, ship routing, and aquaculture, and will be important for understanding the effects of changing ocean content and temperatures on the health of aquatic plants and animals.

Under an experimental arrangement with NASA, the company's SeaStar satellite will collect ocean color data for primary users (including NASA),

who then have the option to sell both unenhanced and enhanced data to other users (figure 4-2). NASA has agreed to purchase data from orbital Sciences in a so-called anchor tenant arrangement in which NASA has paid OSC \$43.5 million up front. This arrangement allowed OSC to seek private financing for design and construction of the satellite.<sup>23</sup>

This experimental data purchase agreement should provide valuable lessons for possible future agreements of a similar character. If it is successful, the Federal Government may purchase quantities of other remotely sensed data from private systems, allowing these firms to earn a profit marketing data to other users.

<sup>22</sup> Built by Hughes Santa Barbara Research Center.

<sup>23</sup> See ch. 7: The Private Sector, for a more detailed discussion of this arrangement.

### Box 4-B-System Tradeoffs

Remote sensing instrumentation can be launched into space in a variety of orbital altitudes and inclinations; instruments can be flown on endo-atmospheric systems-aircraft, balloon, and remotely piloted aircraft; or they can be sited on the ground. The selection of a particular "system architecture" for a given mission typically involves many compromises and tradeoffs among both platforms and sensors. For imaging missions based on satellites, the most important factors indetermining overall system architecture include the required geographical coverage, ground resolution, and sampling time-intervals. These affect platform altitude, numbers of platforms, and a host of sensor design parameters. Each remote sensing mission will have unique requirements for spatial, spectral, radiometric, and temporal resolution. A number of practical considerations also arise, including system development costs; the technical maturity of a particular design; and power, weight volume, and data rate requirements.

Spectral *resolution* refers to the capability of a sensor to categorize electromagnetic signals by their wavelength. *Radiometric resolution* refers to the accuracy with which the intensities of these signals can be recorded. Finally, *temporal resolution* refers to the frequency with which remote sensed data are acquired. It is also possible to categorize the "coverage" of three of the instruments' four resolutions: spatial coverage is a function of sensor field of view; spectral coverage refers to the minimum and maximum wavelengths that can be sensed; and radiometric coverage refers to the range of intensities that can be categorized. The required measurement intervals vary widely with mission. For example, data on wind conditions might be required on time scales of minutes; data on crop growth might be needed on time scales of a week or more; and data on changes in land use are needed on time scales of a **year or more**.

Sensor design requires tradeoffs among the four "resolutions" because each can be improved only at the expense of another. Practical considerations also force tradeoffs; for example, on Landsat, multispectral and spatial data compete for on-board storage space and fixed bandwidth data communication channels to ground stations. For a given swath width, the required data rate is inversely proportional to the square of the spatial resolution and directly proportional to the number of spectral bands and the swath width. For example, improving the resolution of Landsat from 30 m to 5 m would raise the data rate by a factor of 36. Adding more bands to Landsat would also increase the required data rate. Changing the width of coverage can increase or decrease the required data rate proportional to the change in swath width. The baseline design for a proposed high-resolution imaging spectrometer (HIRIS) sensor would have 192 contiguous narrow spectral bands and a spatial resolution of 30 m.<sup>1</sup> To accommodate these requirements, designers chose to limit the ground coverage and thereby reduce the swath width of **the sensor**. HIRIS would have been used as a "targeting" instrument and would not acquire data continuously.

Spatial resolution drives the data rate because of its inverse square scaling. One way to reduce the data rate requirements without sacrificing spatial resolution is to reduce the field of view of the sensor.<sup>2</sup> Designing multispectral sensors that allow ground controllers to select a limited subset of visible and infrared bands from a larger number of available bands is another option to lower data rates?

<sup>1</sup> HIRIS was eliminated as an EOS instrument during the restructuring of EOS (see ch. 5: Global Change Research).

<sup>2</sup> The different resolutions can be traded against ground coverage. For example, the French SPOT satellite offers 10 m resolution in black and white, but its ground swath width is 60 km versus Landsat 5's 185 km.

<sup>3</sup> Data compression is another option to reduce data rates. A lossless compression would allow the full set of raw data to be recovered; reductions in data rates of approximately a factor of two might be gained implementing these algorithms. Most researchers prefer this to a data set that has been pre-processed in away that destroys some data (but reduces data rate requirements) because "one person's noise can prove to be another person's signal."

SOURCE: 19S3 Landsat Short Course, University of California Santa Barbara and Hughes SBRC; Office of Technology Assessment 1993.

## | United States

### GEODESY SATELLITE (GEOSAT)

Launched in 1985, this satellite carried an improved version of the altimeter that flew on Seasat. Designed by the U.S. Navy primarily for collecting precise measurements of ocean topography for military use, the satellite was initially placed into a 108° orbit. The data from this part of the mission were classified but have recently been released for scientific use. The satellite was later maneuvered into a different orbit in order to collect data that would allow oceanographers to determine changes in ocean topography. Geosat operated until 1989. The Navy plans to replace it with Geosat Follow On (GFO), which would fly in an orbit that is 1800 out of phase with the orbit of Geosat. Current plans call for a 1995 launch of GFO.

## | Russia

### ALMAZ

From March 1991 until November 1992, Almaz-1, a large spacecraft equipped with synthetic aperture radar (SAR), provided radar images of the oceans and Earth's surface.<sup>24</sup> Almaz (Russian meaning "diamond") orbited Earth in a 300 km-high orbit, providing coverage of designated regions at intervals of 1 to 3 days. Imagery was recorded by onboard tape recorders, then transmitted in digital form to a relay satellite that, in turn, transmitted the data to a Moscow-based receiving facility. The imagery formed a hologram recorded on high-density tape for later processing as a photograph. Alternatively, a digital tape can be processed. Hughes STX Corp.

of Lanham, Maryland, is the exclusive worldwide commercial marketer, distributor, processor, and licensor of data from the Almaz-1 spacecraft.<sup>25</sup> A second Almaz satellite is available for launch if the funds can be found to launch and operate it. Although the cost of such an operation is reported to be extremely low compared to other SAR satellites, NPO Machinostroyenia, the satellite builder, has not yet found an investor.

## | Sensor Design and Selection

Each remote sensing mission has unique requirements for spatial, spectral, radiometric, and temporal resolution. A number of practical considerations also arise in the design process, including system development and operational costs; the technical maturity of a particular design; and power, weight, volume, and data rate requirements. Because it is extremely expensive, or perhaps impossible, to gather data with all the characteristics a user might want, the selection of sensors or satellite subsystems for a mission involving several tasks generally involves compromises (box 4-B).

Sensor performance may be measured by spatial and spectral resolution, geographical coverage, and repeat frequency. In general, tradeoffs have to be made among these characteristics. For example, sensors with very high spatial resolution are typically limited in geographical coverage. Appendix B provides a detailed discussion of these technical issues. It also discusses many technical and programmatic concerns in the development of advanced technology for remote sensors and satellite systems.

<sup>24</sup> Cosmos-1870, a similar bus-sized, radar-equipped prototype spacecraft was launched in 1987. Cosmos-1870 operated for 2 years, producing radar imagery of 25-30 m resolution.

<sup>25</sup> Earlier, Almaz Corp. was formed to stimulate commercial use of the satellite data.



# Global Change Research | 5

**G**lobal change encompasses many coupled ocean, land, and atmospheric processes. Scientists currently have only a modest understanding of how the individual elements that affect climate, such as clouds, oceans, greenhouse gases, and ice sheets, interact with each other. Additionally, they have only limited knowledge about how ecological systems might change as the result of human activities (plate 7) and natural Earth processes. Because changes in climate and ecological systems may pose a severe threat to mankind, but the uncertainties in both are extremely large, the study of global change has assumed major importance to the world. Consequently, scientists and concerned policymakers have urged development of an integrated program of Earth observations from space, in the atmosphere, and from the surface.

## THE U.S. GLOBAL CHANGE RESEARCH PROGRAM

The U.S. Government has developed a comprehensive research program to gather data on global change and evaluate its effects (box 5-A). The diverse elements of the U.S. Global Change Research program (USGCRP) are coordinated by the Committee on Earth and Environmental Sciences (CEES), a committee of the Federal Coordinating Council for Science, Engineering Sciences, and Technology (FCCSET), within the Office of Science and Technology Policy.

The U.S. effort to study global change responds in part to an international framework of research and policy concerns articu-

---

<sup>1</sup>Uncertainties in possible adaptation strategies are also extremely large. See the forthcoming **report** of an assessment of systems at risk from global change, Office of Technology Assessment.

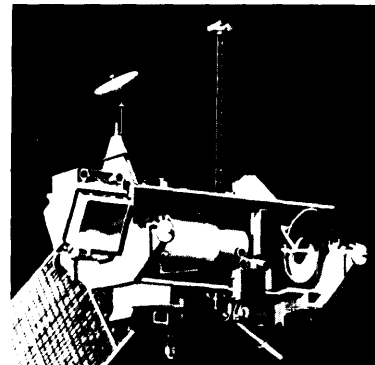

### Box 5-A—U.S. Global Change Research Program

Global environmental and climate change issues have generated substantial international research activity. Increased data on climate change and heightened international concern convinced the U.S. Government of the need to address global change in a systematic way. In 1989, the Director of the Office of Science and Technology Policy, D. Allan Bromley, established an inter-agency U.S. Global Change Research Program (USGCRP) under the Committee on Earth and Environmental Sciences.<sup>1</sup> Established as a Presidential Initiative in the FY 1990 budget, the goal of the program is to provide the scientific basis for the development of sound national and international policies related to global environmental problems. The USGCRP has seven main science elements:

- . climate and hydrodynamic systems,
- . biogeochemical dynamics,
- . ecological systems and dynamics,
- . earth systems history,
- . human interaction,
- . solid earth processes, and
- . solar influences.

Participation in the USGCRP involves nine government agencies and other organizations.<sup>2</sup> Research efforts coordinated through the USGCRP seek a better understanding of global change and the effects of a changing environment on our daily lives. Most research projects rely on remote observations of atmosphere, oceans, and land for data. Coordination of research across agencies **should eliminate duplication and increase cooperation, and at minimum will promote communication** between agencies. The Committee on Earth and Environmental Sciences (CEES) makes suggestions to federal agencies, and federal agencies can raise items for consideration through the CEES. Although this process can be cumbersome, most researchers acknowledge that the program has brought a degree of coordination never before seen in federally sponsored research of this type. However, the attempts at coordination do not assure a comprehensive program that tackles the most important issues. In addition, now that the USGCRP is underway, it is no longer treated as a Presidential Initiative. This change of status has led to concerns that funds previously “fenced off” for global change research will not be forthcoming.<sup>3</sup>

<sup>1</sup>For further information see Committee on Earth and Environmental Sciences, *Our Changing Planet: The FY 1993 U.S. Global Change Research Program* (Washington, DC: National Science Foundation, 1993).

<sup>2</sup>Including the Smithsonian Institution and the Tennessee Valley Authority.

<sup>3</sup>These issues are addressed in a forthcoming OTA background paper, *EOS* and the *USGCRP*.

SOURCE: Office of Technology Assessment, 1993.

lated in reports of the Intergovernmental Panel on Climate Change (IPCC), the International Geosphere-Biosphere Programme, and the World Climate Research Programme (WCRP) and supported by numerous national scientific panels. The USGCRP is attempting to “produce a predictive understanding of the Earth system to support . . . national and international policymak-

ing activities that cover a broad spectrum of global and regional environmental issues,” by:

- documenting global change,
- . enhancing understanding of key processes, and
- . predicting global and regional environmental change.

<sup>2</sup>Committee on Earth and Environmental Sciences, *Our Changing Planet: The FY 1993 U.S. Global Change Research Program* (Washington DC: National Science Foundation, 1993), pp. 3-4.

## NASA'S MISSION TO PLANET EARTH

NASA established its Mission to Planet Earth (MTPE) in the late 1980s as part of its program in Earth sciences. MTPE includes the Earth Observing System (EOS), which consists of a series of satellites capable of making comprehensive Earth observations from space (figure 5-1);<sup>3</sup> Earth Probe satellites for shorter, focused studies (box 5-B); and a complex data archiving and distribution system called the Earth Observing System Data and Information System (EOSDIS). Until NASA launches the first EOS satellite, MTPE research scientists will rely on data gathered by other Earth science satellites, such as UARS, the U.S.-French TOPEX/Poseidon,<sup>4</sup> Landsat, and NOAA's environmental satellites. Data from the EOS sensors may provide information that will reduce many of the scientific uncertainties cited by the IPCC--climate and hydrologic systems, biogeochemical dynamics, and ecological systems and dynamics.<sup>5</sup> NASA has designed EOS to provide calibrated data sets<sup>6</sup> of environmental processes occurring in the oceans, the atmosphere, and over land.

EOS science priorities (table 5- 1) are based primarily on recommendations from the Intergovernmental Panel on Climate Change and CEES of the FCCSET. NASA has designed EOS to **return data over at least 15 years of operation; its scientific value will be compromised if measurements begun in the late 1990s do not continue well into the next century. This raises a critical issue for Congress: whether a commit-**

**ment to an Earth Observing System, which may require outlays on the order of \$1 billion/year in current dollars through about 2015, is sustainable.** Maintaining this level of investment will require Congress' continued interest in measuring climate and environmental parameters and assessing the causes of global environmental change in the face of other demands on the Federal budget. It will also require continuing, clear support from several presidential administrations.

NASA'S early plan for EOS was extremely ambitious, technically risky, and costly. In 1991, Congress told NASA that it should plan for reduced future funding for the first phase of EOS (fiscal year 1992 through fiscal year 2000), and to cut its funding expectations from a projected \$17 billion to \$11 billion.<sup>7</sup> This reduction led to a major restructuring of the EOS program.<sup>8</sup> In the restructuring, NASA retained instruments that focus on climate issues and reduced or eliminated those that would have emphasized gathering data on ecology and observations of Earth's surface. **The restructured program's first priority is acquiring data on global climate change.** As a result, NASA has de-emphasized missions designed to improve scientific understanding of the middle and upper atmosphere and of solid Earth geophysics. The development of remote sensing technology has also been affected by these shifts as NASA has de-emphasized advanced sensors for very high-resolution infrared, far-infrared, and sub-millimeter wave spectroscopy. NASA also

<sup>3</sup> See app. A for a summary of the MTPE instruments and satellites.

<sup>4</sup> This U.S./French cooperative satellite was successfully launched into orbit Aug. 10, 1992 aboard an Ariane 4 rocket.

<sup>5</sup> "Our Changing Planet: the FY 1991 Research Plan," The U.S. Global Change Research Program, a report by the Committee on Earth and Environmental Sciences, October 1990.

<sup>6</sup> NASA has proposed to build and launch two sets of three satellites. The first set (called the AM satellite because it will follow a polar orbit and cross the equator every morning) would be launched in 1998, 2003, and 2008. The second set (called the PM satellite) would be launched in 2000, 2005, and 2010.

<sup>7</sup> U.S. Senate, Committee on Appropriations, "Departments of Veterans Affairs and Housing and Urban Development, and Independent Agencies Appropriation Bill, 1993," report to accompany H.R. 2519, 102-107, July 2, 1992, pp. 52-53.

<sup>8</sup> A number of scientists urged NASA to restructure the program on grounds of technical and programmatic risk. See, for example, "Report of the Earth Observing System (EOS) Engineering Review Committee," September 1991; Berrien Moore III, "Payload Advisory Panel Recommendations," NASA manuscript, Oct. 21-24, 1991.

Figure 5- —NASA's Planned Earth Observing System Satellites and Sensors

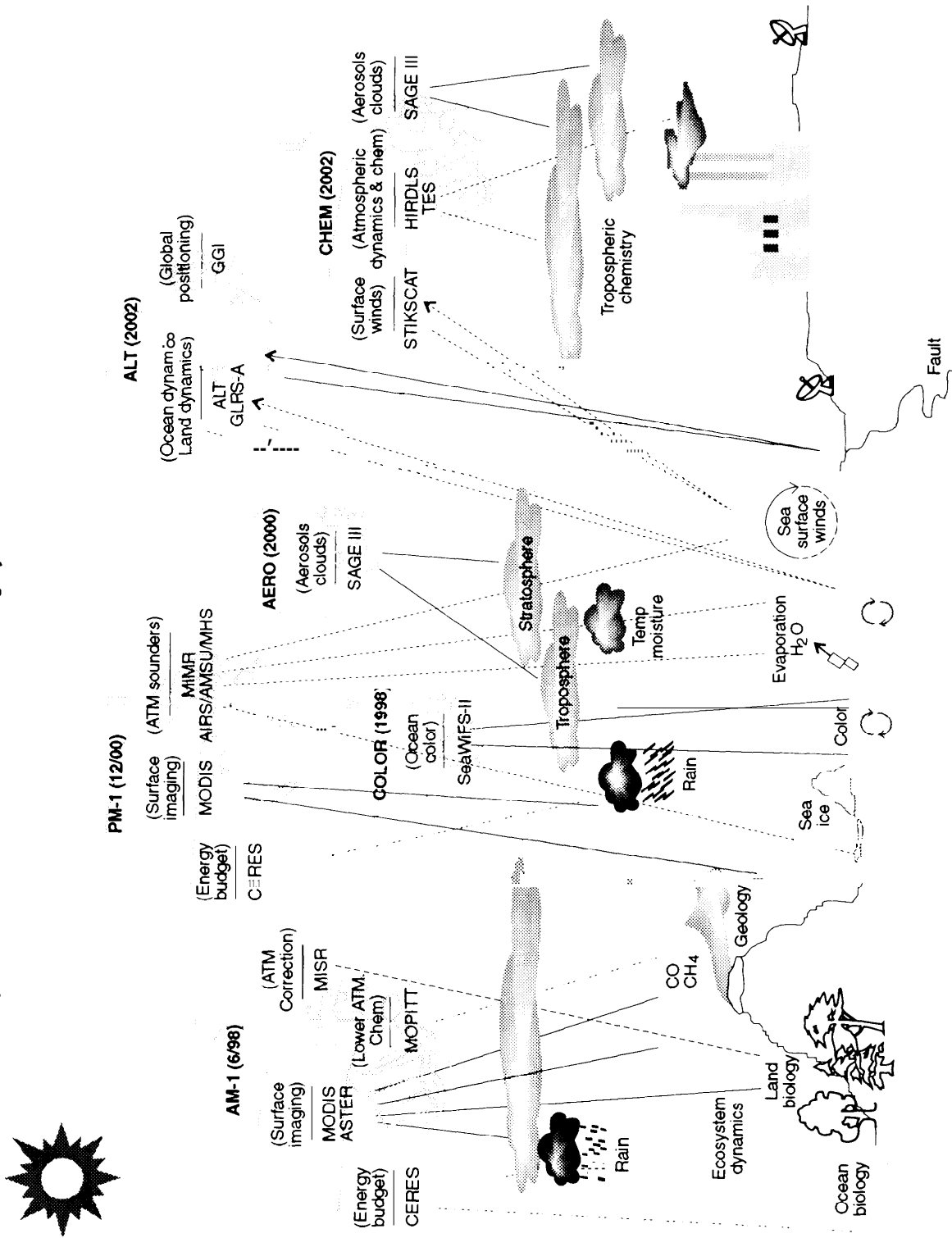

The figure depicts the primary function of major instruments on board six of the EOS satellites. These sensors will measure various Earth and atmospheric processes. Most sensors are passive, with two active sensors distinguished by arrowheads. SOURCE: National Aeronautics and Space Administration, 1992.

### Box 5-B—NASA's Earth Observing System (EOS)

EOS is the centerpiece of NASA's contribution to the Global Change Research Program. Managed by NASA's newly created Mission to Planet Earth Office,<sup>1</sup> EOS is to be a multiphase program lasting about two decades. The original EOS plan called for NASA to build a total of six large polar-orbiting satellites, which would fly two at a time on 5-year intervals over a 15-year period. In 1991, funding constraints and concerns over technical and budgetary risk<sup>2</sup> narrowed its scope.

The core of the restructured EOS consists of three copies each of two satellites (smaller than those originally proposed, and capable of being launched by an Atlas II-AS booster), designed to observe and measure events and chemical concentrations associated with environmental and climate change. NASA plans to place these satellites, known as the EOS-AM satellite (which will cross the equator in the morning while on its

ascending, or northward, path) and EOS-PM satellite (an afternoon equatorial crossing) in polar orbits. The three AM satellites will carry an array of sensors designed to study clouds, aerosols, Earth's energy balance, and surface processes (figure 5-2). The PM satellites will take measurements of clouds, precipitation, energy balance, snow, and sea ice.

NASA plans to launch several "phase one" satellites in the early and mid 1990s that will provide observations of specific phenomena. Most of these satellites pre-date the EOS program and are funded separately. The Upper Atmosphere Research Satellite (UARS), which has already provided measurements of high levels of ozone-destroying chlorine oxide above North America, is an example of an EOS phase one instrument. NASA's EOS plans also include three smaller satellites (Chemistry, Altimeter, and Aero), that will observe specific aspects of atmospheric chemistry, ocean topography, and tropospheric winds. In addition, **NASA plans to include data from "Earth Probes," and from additional copies of sensors that monitor ozone and ocean productivity, in the EOS Data and Information System (EOSDIS).**

NASA will develop EOSDIS<sup>3</sup> so it can store and distribute data to many users simultaneously. This is a key feature of the EOS program. According to NASA, data from the EOS satellites will be available to a wide network of users at minimal cost to researchers through the EOSDIS. NASA plans to make EOSDIS a user-friendly, high-capacity, flexible data system that will provide multiple users with timely data as well as facilitate the data archiving process critical to global change research. EOSDIS will require substantial amounts of memory and processing, as well as extremely fast communications capabilities.

<sup>1</sup>Created in March 1993 when the Office of Space Science and Applications was split into the Office of Mission to Planet Earth, the Office of Planetary Science and Astrophysics, and the Office of Life Sciences.

<sup>2</sup>National Research Council Orange Book; "Report of the Earth observing System (EOS) Engineering Review Committee," September 1991.

<sup>3</sup>Hughes Information Technology won the contract to develop EOSDIS in 1992.

SOURCE: Office of Technology Assessment, 1993.

Figure 5-2—Artist's Conception of NASA's Earth Observing System AM-1 Platform, Scheduled 1998 Launch.

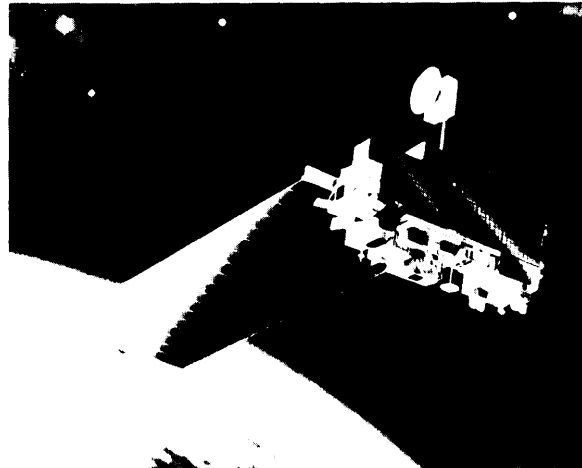

SOURCE: Martin Marietta Astro Space.

**Table 5-1—EOS Science and Policy Priorities<sup>a</sup>**

---

**Water and energy cycles:**

- Cloud formation, dissipation, and radiative properties, which influence the scale and character of the greenhouse effects.
- Large-scale hydrology and moist processes, including precipitation and evaporation.

**Oceans:**

- Exchange of energy and chemicals between ocean and atmosphere and between ocean surface layers and deep ocean.

**Chemistry of troposphere and lower stratosphere:**

- Links to hydrologic cycle and ecosystems, transformation of greenhouse gases in atmosphere, and interactions with climatic change.

**Land surface hydrology and ecosystem processes:**

- Improved estimates of runoff over surface and into oceans.
- Sources and sinks of greenhouse gases.
- Exchange of moisture and energy between land surface and atmosphere.

**Glaciers and polar ice sheets:**

- Predictions of sea level and global water balance.

**Chemistry of middle and upper stratosphere:**

- Chemical reactions, solar-atmosphere relations, and sources and sinks of radiatively important gases.

**Solid Earth:**

- Volcanoes and their role in climate change.

---

<sup>a</sup> List in approximate priority order; these priorities are based on a program that would spend approximately \$8 billion between 1991 and 2000.

**SOURCE:** Berrien Moore III and Jeff Dozier, "Adapting the Earth Observing System to the Projected \$8 Billion Budget: Recommendations from the EOS Investigators," Oct. 14, 1992, unpublished document available from authors or from the NASA Mission to Planet Earth Office.

reduced the size of the planned satellites and increased their number. The restructured program is now more resilient to the loss of a single satellite during launch or in space operations, and more capable of returning some data in the event of fiscal or political changes. NASA also canceled or deferred some sensors that were either unlikely to be ready for launch on either of the first two satellites in the EOS series or too costly to include in the reduced funding profile.

In passing the fiscal year 1993 NASA appropriations, Congress further reduced NASA's future funding expectations for EOS by an additional \$3 billion, an action consistent with NASA's efforts to reduce the costs of large programs. Between fiscal years 1991 and 2000, NASA can now expect to spend \$8 billion for EOS "exclusive of construction of facility, launch, and tracking requirements, but including the Earth Observing System Data and Information System (EOSDIS).<sup>10</sup> NASA has revised its restructured EOS program to account for this projected funding level (box 5-C). As a consequence, NASA has reduced most of the contingency funds, exposing the program to the risk that it will be unable to complete some instruments or may have to cut back on their capacity to acquire certain data.

Additional large budget cut-backs may be difficult to absorb; a third major restructuring might result in the loss of several instruments. Tight budgets have also precluded the development of system backups; this lack of redundancy is an additional risk to the EOS program. The existing \$8 billion program is probably not the program NASA would have designed if it had begun planning EOS with such a budget in mind. In fact, some scientists have suggested that by planning a \$17 billion program and scaling back in accordance with congressional and administration concerns over the future space budget, NASA will be less effective in collecting data for global change research. Nevertheless, the second restructuring still emphasizes the collection of data on climate change, which is the highest priority of the USGCRP. If Congress wishes to continue a U.S. emphasis on global change research, it should support the development of Mission to Planet Earth at a level sufficient to accomplish the science objectives of the U.S. Global

---

<sup>9</sup>The reduction in platform size, which was strongly recommended in the "Report of the **Earth Observing System (EOS) Engineering Review Committee**," allows a reduction in the size and cost of the launch vehicles needed to boost these satellites to space. However, the overall cost for the same data may well be higher **compared** to the original plan that used fewer, larger platforms.

<sup>10</sup>U.S. **Senate**, Committee on Appropriations, "Departments of Veterans Affairs and Housing and Urban Development, and Independent Agencies Appropriation Bill, 1993," report to accompany **H.R. 5679**, 102-356, July 23, 1992, pp. 145-147.

### Box 5-C-The Revised, Restructured EOS Program (1993)

In revising the EOS program from its restructured expected funding level of \$11 billion to \$8 billion over the decade from 1991-2000, NASA:

- Reduced the amount of contingency available for handling unexpected problems in instrument development and changes in the **science requirements**. This has the effect of increasing the financial and technical risk to the program, but it maintains the core instruments on the EOS AM and PM platforms.
- Further increased cooperation with European and Japanese partners in EOS. While this spreads the development burden, it also increases the amount of international program coordination required. It also reduces U.S. influence over the development process. For example, the United States will leave to its partners the development of advanced instruments for active microwave sensing.
- Canceled the proposed LAWS and EOS SAR instruments, deferred HIRIS, and moderately descope other proposed instruments.
- **Reduced the amount of EOSDIS funding by 30 percent**, which forced reductions in the number of EOSDIS products available to researchers.

SOURCE: "Adapting the Earth Observing System to the Projected \$8 Billion Budget: Recommendations from the EOS Investigators," Berrien Moore III, and Jeff Dozier, eds, Oct. 14, 1992. Manuscript.

**Change Research Program. Although NASA was able to absorb substantial reductions of its proposed long term EOS budget by deferring several expensive instruments and concentrating on climate research, additional major cuts in NASA's MTPE budget could sharply reduce the effectiveness of NASA's research.**

As noted above, the restructuring of EOS has shifted NASA priorities and affected instrument selection. As a result:

- NASA has reemphasized measurements of upper atmospheric chemistry in the belief that data from existing satellites such as the Upper Atmosphere Research Satellite (UARS—figure 5-3), supplemented by planned Shuttle ATLAS missions and in-situ airborne and balloon measurements, will be sufficient to monitor ozone depletion and assess the effectiveness of congressionally mandated phase-outs of chlorofluorocarbons (CFCs). NASA has no plans to launch a satellite designed to acquire equivalent data after UARS fails.<sup>11</sup> However, continued satellite measurements will be needed to monitor the health of Earth's protective ozone layer, to guard against scientific surprises, and to provide the necessary scientific rationale for international protocols that limit emissions of ozone-depleting gases. Long-term information about the state of the ozone layer will be particularly important for developing nations where the relative cost of limiting CFC emissions may be highest. NASA intends to provide some of the necessary data with its TOMS instruments.
- Some relatively inexpensive, small satellite projects are threatened with delay or cancellation—for example, the Active Cavity Radiometer Irradiance Monitor (ACRIM),<sup>12</sup> which would be used to continue measurements to monitor the variability of total solar irradiance, may not fly until 2002. Similar concerns exist for SAGE, an instrument designed to monitor tropospheric aerosols. NASA has dropped other advanced technology instruments because of a reduced emphasis on atmospheric chemistry research. Some researchers express concern that in canceling these instruments, the United States will lose the opportunity to make important climate measurements and risk

<sup>11</sup> UARS' planned operation may extend through 1994. Individual instruments and components may fail earlier.

<sup>12</sup> One earlier flights of ACRIM.

**Figure 5-3-Artist's Conception of NASA's Upper Atmosphere Research Satellite**

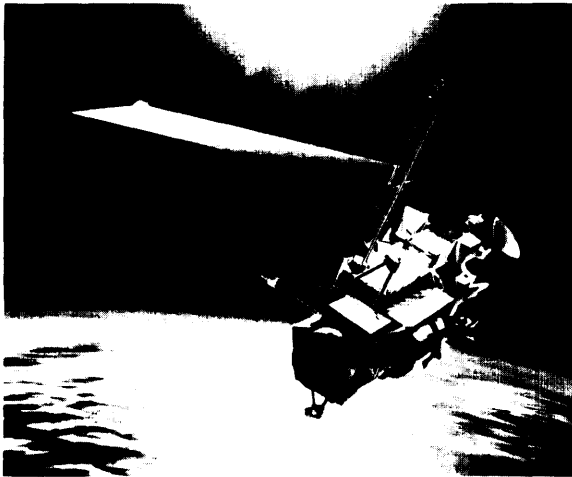

SOURCE: Martin Marietta Astro Space.

reductions in the U.S. technology base for developing advanced instruments.

- NASA has cancelled three important **proposed** instruments: Laser Atmospheric Wind Sounder (LAWS),<sup>13</sup> Synthetic Aperture Radar (SAR),<sup>14</sup> and High Resolution Imaging Spectrometer (HIRIS).<sup>15</sup> All are technically challenging and very expensive to develop.<sup>16</sup> All are also “facility” instruments that would acquire data of interest to a large number of investigators.

Although the technical complexity and challenge of the original EOS program, along with the lack of available funds, has forced many of these changes, data from these instruments would make significant contributions to our understanding of the Earth as an interactive system and of global change. If further research demonstrates that these or similar instruments are needed to support additional progress in understanding global

change, Congress may wish, before the end of the century, to consider supplemental funding for their development.

In the meantime, NASA should continue to develop technology and scientific research related to these technologies and find ways to reduce system costs. Increased cooperation with the DOE-operated national laboratories offers a particularly attractive mechanism to develop the technology base that will be required for **next-generation sensors and spacecraft**. Lawrence Livermore National Laboratory, Los Alamos National Laboratory, and Sandia National Laboratories, in particular, have considerable expertise in spacecraft instrument design. DOE has proposed collaborative projects focusing on the acquisition of data about Earth's radiation budget, an important component of DOE's Atmospheric Radiation Measurement (ARM) program. They have also proposed collaborative projects to develop hyperspectral sensing that could be mounted on satellites or aircraft (the DoD also has an aircraft-based program to develop hyperspectral sensors- 'HYDICE' ).

International cooperation can offer a means to increase the capability of collecting important environmental data while reducing costs for any single government. In order to ease its own cost burden for sensors and satellite systems while maintaining the capability to monitor important features of Earth's environment, NASA has reduced funding for certain sensors and enhanced its cooperative remote sensing programs with other countries. Japan and the European Space Agency are being asked to take on the development of several sensors that would fly on U.S. spacecraft and to provide space on their spacecraft for U.S. sensors. However, international cooperative arrangements can only fill part of the void left by the rapid restructure of EOS. Some of

<sup>13</sup> For **direct measurement** of tropospheric winds at high resolution.

<sup>14</sup> For **making** hi@ resolution radar images of **land, ocean, and ice surfaces**.

<sup>15</sup> For&g high **spatial** resolution images of Earth's surface in some 200 contiguous, **very** narrow infrared and visible **spectral** reds.

<sup>16</sup> See app. B fo, a **more** extensive discussion of these instruments and **their** development.



Table 5-2—The Current EOS Spacecraft Program

Launch	Spacecraft	Lifetime (yrs)	Instrument complement					
1998	AM1	5	MODIS	MISR	CERES (2)	MOPITT	ASTER	
2003	AM2	5	MODIS	MISR	CERES	EOSP	TES	MOPITT*
2008	AM3	5	MODIS	MISR	CERES	EOSO	TES	
1988	COLOR	3	SeaWiFS-Type					
2000	AERO1	3	SAGE III					
2003	AERO2	3	SAGE III					
2006	AERO3	3	SAGE III					
2009	AERO4	3	SAGE III					
2012	AERO5	3	SAGE III					
2000	PM1	5	MODIS	AMSU	MIMR	AIRS	MHS	CERES (2)
2005	PM2	5	MODIS	AMSU	MIMR	AIRS	MHS	CERES
2010	PM3	5	MODIS	AMSU	MIMR	AIRS	MHS	CERES
2002	ALT1	5	GLAS	TMR	SSALT	DORIS		
2007	ALT2	5	GLAS	TMR	SSALT	DORIS		
2012	ALT3	5	GLAS	TMR	SSALT	DORIS		
2002	CHEM1	5	HIRDLS	SOLSTICE II	ACRIM	MLS	SAGE III	TBD(J)
2007	CHEM2	5	HIRDLS	SOLSTICE II	ACRIM	MLS	SAGE III	TBD(J)
2012	CHEM3	5	HIRDLS	SOLSTICE II	ACRIM	MLS	SAGE III	TBD(J)

SOURCE: 1993 EOS Reference Handbook, EOS Program Chronology.

the scientific objectives must be deferred until new domestic or foreign funding sources are made available.

Increased international cooperation in remote sensing is possible because over the past decade other countries have markedly improved their skills in sensor development and satellite systems integration and construction. Canada, France, Germany, the United Kingdom, Japan, Russia, China, and India have made satellite remote sensing a priority. Prospects **for greater international cooperation will increase as the remote sensing programs of other countries grow in technical breadth and capability.**

Some policymakers express the concern that increased cooperation will boost the technical capabilities of other countries by giving foreign industry a chance to develop technology in which the United States has a strong lead. In addition, because foreign experience with some systems is less well developed than that of U.S. industry, some scientists fear sensors developed abroad might be less capable than ones built domestically, leading to incomplete data sets. Hence, in

**order to ensure that the United States does not forfeit the lead in technical capabilities it considers vital to national competitiveness, Congress may wish to scrutinize closely the structure of any international agreements in remote sensing.**

Another problem with international cooperation is that each country has a strong interest in providing the most advanced instruments or systems. The outcome is that a cheap, simple satellite design can quickly grow into a relatively expensive, complex system.

NASA expects to operate EOS and EOSDIS for at least 15 years after the launch of the second major satellite (PM-1) in 2000 (table 5-2). Therefore, the program will necessarily take on the characteristics of what has been called an ‘operational program’—in other words, sustained, routine acquisition of data that must be routinely available to researchers and other users on a timely basis. To **achieve maximum effectiveness, NASA’s EOS Program must be organized and operated with great attention to the regular, timely delivery of data.** This means, for

example, not only that EOSDIS (box 5-D) function smoothly, and in a “user friendly” manner, but that the sensor systems that feed data into EOSDIS are prepared to deliver vast amounts of data with few processing errors or system slowdowns.

### STRUCTURING A ROBUST RESPONSIVE, GLOBAL CHANGE RESEARCH PROGRAM

**NASA plans to use EOS to provide scientists with data relevant to questions that often polarize public debate regarding climate change and its global environmental effects. Although these data may help resolve some contentious scientific issues, they may not produce results that lead to clearcut policy decisions.** Data from instruments aboard EOS and other satellites, as well as from many other sources, will be used to study the effects of global change and to predict possible future changes in Earth’s environment. Unlike the recent observations of ozone-destroying chlorine molecules in the upper atmosphere, which quickly led to a speedup in the phase-out of U.S. chlorofluorocarbon (CFC) production, few of the research questions that can be addressed by the USGCRP will result in straightforward policy responses. Most of these data will provide inputs to complex models intended to predict future climatic and environmental conditions. Because of the complexity of the models, finding sufficient scientific agreement to draw definitive conclusions for policymakers to act on may be especially difficult. Although scientific research may provide evidence linking the production of particular gases to deleterious climate changes, predicting regional environmental changes that could signal major economic disruptions may not be possible for decades. Moreover, even when the facts are known and the processes understood, proposed solutions may not necessarily be clear or uncontroversial. However, the best chance the United

**States has to develop the scientific basis for good policy is to pursue the best science, based on a robust, responsive global change research program. Such a program would include a strong commitment to making observations from instruments based in aircraft, ships, and ground facilities, as well as from space.**

### | Existing Satellite Systems

Most existing space-based remote sensing instruments contribute in some way to global change research—NOAA’s environmental satellites, the Landsat system, and NASA’s research satellites. For example, the polar-orbiting NOAA POES satellites (box 3-D) carry the High Resolution Infrared Radiation Sounder (HIRS) and the Microwave Sounding Unit (MSU), which daily measure atmospheric temperature and humidity, and the Advanced Very High Resolution Radiometer (AVHRR), which can be used to monitor the global state of vegetation, the extent of Arctic and Antarctic ice pack, and sea surface temperatures. Observations from both instruments contribute to research on global change. In general, NOAA instruments provide the long-term data sets necessary for identifying previous trends (plate 9). However, because the instruments **in NOAA’s environmental satellites were designed to serve NOAA’s needs in collecting weather and climate data, these instruments lack the necessary calibration to gather precise data required for sensing and interpreting subtle, gradual changes in the environment. Sensors aboard future NOAA satellites ought to be designed to provide data having better calibration.**<sup>17</sup>

**Remotely sensed data from Landsat, SPOT, ERS-1, JERS-1, and other satellites optimized for imaging surface features will become increasingly important in following local, regional, and global environmental change (plate 7). Landsat and SPOT have contributed significant quantities**

---

<sup>17</sup> Providing better calibration will add to the cost of the sensors, however.

### Box 5-D—Earth Observing System Data and Information System

EOSDIS will consist of 8 interlined Distributed Active Archive Centers (DAACS) and a Socioeconomic Data and Applications Center (SEDAC) that will archive original data, create scientific data products, and make them available to users either at the centers or on line. NASA plans to spend about \$1.5 billion on the development and operation of EOSDIS. This investment will result in a large number of data sets that can be accessed repeatedly by various users. Handling large data sets in an open network presents many challenges, and will push the state of the art in software and communications hardware. EOSDIS will be the key link between the data collected by the satellite systems and the scientists working on global change research.

EOSDIS will challenge NASA's technical and organizational skills in part because the system and its data products cannot be well-defined at this early stage. The data storage and retrieval system will require new image processing techniques capable of handling interrelated data sets, and a transparent "window" for the user. The system must be able to run in multiple operating environments, and be accessible by people possessing different levels of computer skills. EOSDIS will require innovative solutions to data handling that will take years to develop. EOSDIS will also require improved data compression and decompression algorithms. These compression schemes must work at extremely fast data rates, yet not degrade data integrity. Maintaining the data securely is a priority for any large data system, and it will be extremely challenging for an EOSDIS that will be open to hundreds and eventually thousands of users.

If EOS data can reduce scientific uncertainty surrounding atmospheric and environmental changes, the program will be a success. A successful EOS will depend largely on the ability of EOSDIS designers and managers to create a system in which massive amounts of data can be archived, cataloged, maintained, and made routinely accessible to users, and which will maintain the integrity of the data.

NASA's first objective is to expand the amount of earth science data available to the scientists. With help from the science user community, it has identified large, "pathfinder," data sets for inclusion in EOSDIS Version O. Pathfinder sets will include data that have been collected over many years by operational satellites such as NOAA polar orbiters and geostationary satellites and Landsat. EOSDIS will serve as the archive for these data sets, which will assist global change researchers and allow NASA contractors gradually to improve EOSDIS based on experiences of initial users. According to the General Accounting Office, progress on gathering and reprocessing pathfinder data has been slow.<sup>1</sup> Only one complete data set is expected to be available by 1994, and only three complete data sets will be available by 1996. Slow progress on pathfinder data sets may impede planning and development for latter phases of EOSDIS.

<sup>1</sup> U.S. Congress, General Accounting Office, "Earth Observing System: Information on NASA's Incorporation of Existing Data Into EOSDIS," September 1992.

SOURCE: Office of Technology Assessment, 1993.

of high-quality data to archives that can be used to provide early indications of harmful change in localized areas.<sup>18</sup> Existing data, especially those being prepared under the Pathfinder EOSDIS efforts, need to be studied in detail to understand better how to use remotely sensed land data in global change studies.

### | Small Satellites

As instruments aboard satellite systems improve, they are likely to assist in the development of much needed information about the global environment and how it is changing. However, as currently structured, satellite systems may not provide some of the most urgently needed data

<sup>18</sup> See Matthew D. Cross, *Historical Landsat Data Comparisons: Illustrations of Land Surface Change* (Washington, DC: U.S. Geological Survey, 1993), for a sample of the surface changes that Landsat data are capable of revealing. Because these digital data can be readily sorted and manipulated in a computer, and merged with other data, they can be used to make quantitative estimates of change.

**in time to assist the policy debate. In addition, the United States has no plans for monitoring aspects of global change on decadal timescales.** Yet, many climatologists and other scientists believe that monitoring on this timescale will be essential to 1) build databases over sufficiently long periods to support global change research and refine predictive models, and 2) monitor the often subtle climatic and ecological changes induced by anthropogenically produced gases and other pollutants.<sup>19</sup>

Moreover, some researchers argue that the appropriate instrument platforms to carry out **decadal-scale measurements are not the large, complex, and expensive satellites planned for the EOS program. These** researchers argue that a balanced program for global change research would include smaller, less expensive, and less complex satellites that would be developed specifically for particular monitoring missions,<sup>20</sup>

Several agencies, including NASA, DOE, and ARPA, are examining the use of small satellites for global change research. Small satellites, which have been defined as costing \$100 million or less, including spacecraft, instruments, launch, and operations, could:<sup>21</sup>

- address gaps in long-term monitoring needs prior to the launch of EOS missions,<sup>22</sup>
- provide essential information to support process studies prior to, and complementary with, the restructured EOS,
- allow for innovative experiments to improve the ability to monitor key variables or improve/speed up the process studies.<sup>23</sup>

Matching small instruments with small satellites has several potential advantages: First, it avoids the necessity of integrating multiple instruments on a single platform—this simplifies the acquisition process, albeit at a possibly higher overall cost. Second, shortening the time to launch would add resilience to the satellite portion of the global change research program, large parts of which are frozen in development some 10 years before flight. Third, flying only a small number of instruments per satellite allows scientists to optimize the satellite orbit for a particular set of measurements.<sup>24</sup> Finally, flying small instruments on small satellites increases the likelihood that a small core of key environmental sensors can:

- be launched before the EOS system and thus prevent data gaps that would otherwise be created in the mid-to-late 1990s (before EOS launches);
- be maintained even if EOS suffers further cutbacks; and
- be maintained for years beyond the scheduled 15-year lifetime of the EOS system.

However, the funding for such satellites would have to come from some other source than the EOS program. Otherwise, the deployment of the first EOS satellites (AM-1998; PM—2000) would risk being delayed.

Global change researchers express widespread agreement on the desirability of using small satellites for these three roles. However, scientists express sharp disagreements about the long-term

<sup>19</sup> For example, the burning of fossil fuels, use of CFCs, and agriculture.

<sup>20</sup> Liz Tucci, "EOS Backers Push for Faster Launches," *Space News*, Mar. 29, 1993, p. 14.

<sup>21</sup> See Committee on Earth and Environmental Sciences (CEES) of the Federal Coordinating Council for Science, Engineering, and Technology, *Report of the Small Climate Satellites Workshop* (Washington DC: Office of Science and Technology Policy, May 1992).

<sup>22</sup> Gap-filling spacecraft were initially proposed in 1991. With the first EOS launch scheduled for 1998, the opportunity for using these spacecraft is fast drawing to a close.

<sup>23</sup> *Report of the Small Climate Satellites Workshop*, pp. 20–21. As noted in the text, researchers at the Goddard Institute for Space Studies have also proposed using small satellites for long-term (decadal-scale) monitoring in a program that would complement EOS.

<sup>24</sup> Some missions require nearly simultaneous measurements by instruments that cannot be packaged on a single, small satellite. In this case, a larger platform carrying several instruments may be desirable. Alternatively, small satellites could be flown in close formation.

potential for small satellites to replace larger, more expensive satellites such as Landsat. Advocates of small satellites believe satellite weight and volume can be reduced by incorporating advanced technologies, now in development, with next generation spacecraft. However, proposed new instrument technologies are typically at an early stage of development and their capability to provide the stable, calibrated measurements required for global change research is likely to be unproved. Stability and calibration requirements are particularly important for long-term monitoring. Fully developed data processing systems and well-understood data reduction algorithms are also required to transform raw data into useful information.<sup>25</sup>

Historically, satellite designers have minimized risk by introducing advanced technology in an evolutionary manner; typically, only after it has been proven in the laboratory and acquired a heritage of space worthiness. Although experts generally agree on the desirability of accelerating this relatively slow process, they do not agree on the risk that would be associated with a change in the traditional development cycle.<sup>26</sup> **The risks in developing a new sensor system have two components: the technical maturity of component technologies (for example, the detector system), and the design maturity. A particular design that has not been used before may be a relatively risky venture for an operational program, even if it is based on proven technology.** Several proposals have been made to reduce the risks of inserting new technologies into operational programs. Box 5-E summarizes one

#### Box 5-E-The Advanced Research Projects Agency CAMEO Program

ARPA has proposed several advanced technology demonstrations (ATDs) on small satellites that, if successful, would rapidly insert technology and shorten acquisition time for larger satellites.' These demonstrations would couple innovative sensor design with a scalable high-performance common satellite bus that would employ a novel "bolt-on" payload-bus interface. ARPA-proposed ATDs include ATSSB (advanced technology standard satellite bus) and CAMEO (collaboration on advanced multi-spectral Earth observation). They were fully supported by the Department of Defense, but were eliminated by the Senate Appropriations Committee for fiscal year 1993.

<sup>1</sup> See app. B for more detail on this proposal.  
SOURCE: Advanced Research Projects Agency, 1993.

example from the Advanced Research Projects Agency.

To date, budget constraints, scientific disputes over the merits of specific proposals, intra-agency and inter-agency rivalries, and the absence of a coherent strategy, developed within the executive branch and supported by the relevant authorization and appropriation committees **of Congress, has limited efforts to develop and flight-test emerging technologies.** Appendix B discusses these issues at greater length along with specific proposals for launching small EOS satellites. Appendix B also notes that the development of innovative, lightweight sensors appropriate for small satellites and the development of sensors for long-endurance, high-altitude UAVS share many common features.

<sup>25</sup> An illustrative example is given by the complex analysis that is required to measure the Earth's radiation budget (see app. B).

<sup>26</sup> A phased development cycle has traditionally been used to procure operational systems. The steps in this cycle can be grouped as follows:

Phase A—Study Alternate Concepts;

Phase B—Perform Detailed Design Definition Study (manufacturing concerns addressed in this stage);

Phase C—Select Best Approach/Build and Test Engineering Model;

Phase D—Build Flight Prototype and Evaluate on Orbit.

This approach should be contrasted with a "skunk-works" approach, which omits some of these steps. Historically, the skunk-works approach has usually been thought more risky than the methodical approach. As a result, it has been used mostly for demonstrations and experiments.

### Box 5-F-Radiative Forcings and Feedbacks

Radiative forcings are changes imposed on the planetary energy balance; radiative feedbacks are changes induced by climate change. Forcings can arise from natural or anthropogenic causes (see table 5-3). For example, the concentration of sulfate aerosols in the atmosphere can be altered by both volcanic action (as occurred following the eruption of Mt. Pinatubo in **June 1991**) or from **power generation using fossil fuels**. The distinction between forcings and feedbacks is sometimes arbitrary; however, scientists generally refer to forcings as quantities that are normally specified, for example, CO<sub>2</sub> amount, while feedbacks are calculated quantities. Examples of radiative forcings are greenhouse gases (CO<sub>2</sub>, CH<sub>4</sub>, CFCS, N<sub>2</sub>O, OS, stratospheric H<sub>2</sub>O), aerosols in the troposphere and stratosphere, solar irradiance, and solar reflectivity. Radiative feedbacks include clouds, water vapor in the troposphere, sea-ice cover, and snow cover.

SOURCE: office of Technology Assessment, 1993 and Dr. James Hansen, Goddard Institute for Space Studies.

Climsat satellites would be flown in pairs, one in polar and the other in inclined orbit.<sup>27</sup> Each would carry three small, lightweight instruments (see box 5-G). Climsat satellites would be self-calibrating,<sup>28</sup> small enough to be orbited with a Pegasus-class launcher,<sup>29</sup> long-lived (nominally 10 years or more), and relatively inexpensive.<sup>30</sup> The originators of the Climsat proposal believe it could provide most of the missing data required to analyze the global thermal energy cycle, specifically long-term monitoring of key global climate forcings and feedbacks. In addition, proponents claim Climsat would be a more “resilient” system than EOS because it would launch a small complement of relatively inexpensive instruments on small satellites. However, Climsat alone is not intended to fulfill the broader objectives of the Mission to Planet Earth and the Earth Observing System Program.

Monitoring of global radiative forcings and feedbacks is essential to understanding the causes, time-scale, and magnitude of potential long-term changes in global temperature. However, a program to correlate changes in average temperature with changes in radiative forcings and feedbacks is expected to require measurements that would extend over decades. Unlike EOS satellites, which NASA proposes to fly for a total of 15 years, Climsat satellites would be operated for several decades.<sup>31</sup>

## ■ Climsat

Present and future global climate change cannot be interpreted without knowledge of changes in climate forcings and feedbacks (box 5-F). “Climsat” is the name of a proposed system of environmental satellites that would carry out long-term monitoring of the Earth’s spectra of reflected solar and emitted thermal radiation.

<sup>27</sup> As described in the text, **two satellites are** specified in the **Climsat** proposal because this **number** is necessary for global COverage and adequate sampling of diurnal variations.

<sup>28</sup> SAGE calibration is obtained by viewing the sun (or moon) just before or after every occultation. MINT records its **interferogram** on a single detector and therefore would have high wavelength-to-wavelength precision. EOSP interchanges the roles of its detector pairs periodically. Stable internal lamps are used for radiance calibration.

<sup>29</sup> A launch on Pegasus costs about \$10-12 million. Pegasus can carry payloads weighing up to 900 pounds.

<sup>30</sup> Cost estimates **are uncertain at an early** stage of concept **definition**. However, two of the three **Climsat instruments have gone through phase A/B studies in EOS**, leading Goddard Institute of Space Studies researchers to make the following estimates:

SAGE III—\$34 million for 3 EOS copies (**18** million for **first** copy);

EOSP—\$28 million for 3 EOS copies (\$16 million for **first** copy);

MINT—\$15-20 million for **first** copy.

<sup>31</sup> **EOS officials agree that decadal-scale monitoring of the Earth** is needed; **they** foresee some subset of EOS instruments evolving **into** operational satellites designed for long-term monitoring.

Table 5-3-Human Influence On Climate

**Fossil fuel combustion**

- CO<sub>2</sub> emission (infrared (IR) trapping).
- CH<sub>4</sub> emission by natural gas leakage (IR trapping).
- NO, NO<sub>2</sub> emission alters O<sub>3</sub> (ultraviolet absorption and IR trapping).
- Carbonaceous soot emission (efficient solar absorption).
- SO<sub>2</sub>-Sulfate emission (solar reflection and IR trapping).

**Land use changes**

- Deforestation (releases CO<sub>2</sub> and increases surface albedo)
- Regrowth (absorbs CO<sub>2</sub> and decreases surface albedo).
- Biomass burning (releases CO<sub>2</sub>, NO, NO<sub>2</sub>, and aerosols).

**Agricultural activity**

- Releases CH<sub>4</sub> (IR trapping).
- Releases N<sub>2</sub>O (IR trapping).

**Industrial activity**

- Releases CFCs (IR trapping and leads to ozone destruction).
- Releases SF<sub>6</sub>, CF<sub>4</sub>, and other ultra-longlived gases (IR trapping virtually forever).

KEY: CF<sub>4</sub> = carbon tetrafluoride; CO<sub>2</sub> = carbon dioxide; CH<sub>4</sub> = methane; NO = nitric oxide; NO<sub>2</sub> = nitrogen dioxide; N<sub>2</sub>O = nitrous oxide; O<sub>3</sub> = ozone; SO<sub>2</sub> = sulfur dioxide; SF<sub>6</sub> = sulfur hexafluoride; CFCs = chlorofluorocarbons.

SOURCE: Jerry D. Mahlman, "Understanding Climate Change," Draft Theme Paper, prepared for Climate Research Needs Workshop, Mohonk Mountain House, Nov. 8, 1991.

Both the initial EOS program and the initial Climsat proposal have been revised since their initial presentations. Versions of two of the three Climsat instruments are now scheduled for flight on later EOS missions. However, Climsat supporters argue that flying these instruments as part of Climsat would:

- allow flight in proper orbits;
- guarantee overlapping operations (over longer periods), which would result in better calibrated measurements;
- allow launch several years before the relevant EOS platforms;<sup>32</sup> and
- allow instrument modification on a shorter time-scale than EOS instruments and thus be better able to respond to scientific surprises.

Supporters also argue that Climsat instruments are better designed to handle scientific surprises because:

- unlike related larger instruments on EOS, they cover practically the entire reflected solar and emitted thermal spectra, and
- the Climsat instruments measure the polarization as well as the mean intensity of the solar spectrum where polarization is highly diagnostic of the observed scene.

A key argument in favor of the Climsat proposal is its potential to carry out a core group of key remote sensing measurements on a decadal time-scale. In effect, supporters of Climsat argue that the data that would be gathered by Climsat—or a similar system—is too important to be tied to the budgetary fate and schedule of EOS. Detractors of the Climsat proposal include those who believe that its funding could come only at the detriment of an already diminished EOS program. Further, they contend that Climsat addresses only a narrow part of the climate problem. For example, they question whether data from Climsat are, in fact, more important than data on ocean color, land-surface productivity, atmospheric temperature and humidity, and snow and ice volume.

### | Complementing Satellite Measurements

Satellites alone cannot carry out a robust program of global change research. Orbiting above the atmosphere, a satellite remote sensing system receives information about atmospheric or terrestrial processes only via electromagnetic signals reflected or emitted from the atmosphere or the surface. Sensors collect these signals and transform them into forms that can be used as input data for analysis and interpretation. Scientists need to compare satellite data with surface-based or airborne measurements to verify that the satellite data are free of unforeseen instrument

<sup>32</sup> Dr. James Hansen, developer of the Climsat proposal, estimates that the Climsat satellite would require 3 years to build and launch after approval and procurement processes are complete.

### Box 5-G - The Data Storage Problem

The sheer size of archives for remotely sensed Earth data can be estimated through some simple calculations. The data storage requirement is the product of the storage needed for each pixel and the number of pixels. Such a calculation is done in terms of “bits,” the 0’s and 1’s used in computers’ binary arithmetic.

As an example, consider an Earth’s worth of Landsat-like pictures from a notional satellite with 10 bands, each imaging 25- X 25-meter pixels in terms of 32 brightness levels. The 32 gradations of brightness are expressed by 5 bits, so each square kilometer, consisting of 1,800 pixels, requires  $1,800 \times 10 \times 5 = 80,000$  bits, or 10 kilobytes. (For comparison’s sake, this box requires about 2 kilobytes of computer storage.) The Earth’s 200 million square kilometers of land, therefore, would require 2 billion kilobytes of storage capacity.

Two billion kilobytes is roughly the storage capacity of 20 million **late-model** home computers or 3,000 compact disc recordings.

The Human Genome Project, to take another example of data collection and storage, will not have to deal with nearly this much data. The genome consists of 3.3 billion base pairs, each embodying 1 bit. Thus the genome is “only” 3,300 megabits, or about 400 megabytes-about the contents of half a compact disc.

To observe change, or the most current situation, further pictures are needed and must be stored. Each adds another 2 billion kilobytes. Inclusion of the water-covered three-quarters of the Earth’s surface would increase the size of each picture to 8 billion kilobytes, and “hyperspectral” techniques, involving 100 bands instead of 10, would increase storage needs an additional tenfold.

SOURCE: office of Technology Assessment, 1993.

artifacts or unforeseen changes in instrument calibration. These comparisons are particularly important for long-term measurements and for measurements that seek to measure subtle changes. Satellite data must also be corrected to account for the attenuation and scattering of electromagnetic radiation as it passes through the Earth’s atmosphere. In addition, corrections are necessary to account for the variations in signal that occur as a result of changes in satellite viewing angle. Nonsatellite data can also assist in the analysis of satellite data by clarifying ambiguities in the analysis and confirming certain measurements. Finally, sensors on satellites may be limited in their capability to make measurements in the lower atmosphere, and they may be unable to make the detailed measurements required for certain process studies.

Balloons and aircraft are generally more “responsive” than satellites: in general, an experiment to monitor a specific process can be

mounted faster on an aircraft or balloon experiment than on a satellite. Furthermore, as noted earlier, the development of instrumentation on airborne platforms greatly assists the development of space-qualified instrumentation for satellites. However, balloons and aircraft cannot be used for monitoring global phenomena that have small-scale variability because their coverage is limited in time (intermittent coverage, weather restrictions) and space (altitude ceilings, geographic restrictions).

### | Process Studies and Unpiloted Air Vehicles

“Process”<sup>33</sup> studies, which are necessary to understand global forcings and feedbacks in detail, require ground and in situ measurements. For example, a detailed understanding of the kinetics and photochemistry that govern the formation of the Antarctic ozone hole (and the

<sup>33</sup> There is no clear delineation between “process” studies and monitoring studies. In general, global change researchers use the term “process study” to refer to shorter term, less costly, and more focused experiments that aim to elucidate the details of a particular mechanism of some geophysical, chemical, or biological interaction.



role of the Antarctic vortex) has only been possible with in situ balloon and high-altitude aircraft measurements.<sup>34</sup> Development of high altitude unpiloted aircraft would extend these measurements, which would be especially useful in elucidating the mechanisms that cause significant loss of ozone over the Arctic and northern latitudes.

High-altitude unpiloted air vehicles (UAVS) offer significant advantages over satellites for measuring some upper atmospheric constituents. In particular, they can be used for accurate in situ measurements-actually sampling the constituents of the upper atmosphere and using the samples to decipher, for example, the chemical reactions taking place among stratospheric ozone, chlorine monoxide, bromine monoxide and other man-made substances. Because instruments on UAVS can be changed or adjusted after each flight, UAVS are also potentially more responsive than satellite systems to new directions in research or to scientific surprises. Unlike balloons, they move through the air, rather than with it, allowing operators to guide their paths.

In addition to its use of high-altitude balloons and piloted aircraft, NASA plans to employ a small UAV called *Perseus*, developed by the small private firm, Aurora Flight Services, Inc.<sup>35</sup> for atmospheric studies. The first two *Perseus* aircraft (*Perseus A*) are scheduled for delivery to NASA at a cost of about \$1.5 to \$1.7 million each. NASA will initially use sensors carried on *Perseus* to determine the chemistry and movement of gases in the stratosphere at altitudes up to approximately 25 kilometers (82,000 feet).

UAVS may provide global change researchers with low-cost and routine access to regions of the atmosphere that are inaccessible to piloted aircraft, sampled too infrequently by balloon, and sampled too coarsely by satellites. UAVS should also be highly cost effective in providing crucial in situ measurements of atmospheric chemical constituents. They are also a natural test-bed for small, lightweight instruments proposed for flight on small satellites. Despite their potential to enable measurements that are crucial **for the global change research program, government support for UAV development, and associated instrumentation, has been meager and may be inadequate to provide a robust UAV capability. If Congress wishes to encourage innovation in global change research, it may wish to increase funding for UAVS.** Because of their low development costs, moderate funding increases of only a few million dollars could ultimately lead to a substantial increase in UAV availability for research.<sup>36</sup>

Satellites view the Earth only from above the atmosphere; this limits their measurement of two physical quantities of interest to global change research. One, the angular distribution of radiation, is necessary for measurements of Earth's radiation budget.<sup>37</sup> The other, the "flux divergence," can be related to the net heating that occurs in a particular layer of the atmosphere. It is a fundamental parameter in global circulation models of Earth's atmosphere and climate. UAVS are ideally suited to make these measurements and would complement groundbased observa-

<sup>34</sup>J.G. Anderson, D.W. Toohy, W.H. Brune, "Free Radicals Within the Antarctic Vortex: The Role of CFCS in Antarctic Ozone Loss," *Science*, vol. **251**, Jan. 4, 1991, pp. 39-46.

<sup>35</sup>Richard Monastersky, "Voyage Into Unknown Skies," *Science News*, vol. **139**, Mar. 2, 1991, pp. 136-37; Michael A. Dornheim, "Perseus High-Altitude Drone to Probe Stratosphere for SST Feasibility Studies," *Aviation Week and Space Technology*, Dec. 9, 1991, pp. 36-37.

<sup>36</sup>NASA is now asking for additional funding of \$90 million over 5 years to build and fly UAVs for scientific research.

<sup>37</sup>The Earth's "radiation budget" consists of incident sunlight minus reflected sunlight (for example, from the tops of clouds) and radiation emitted back to space, primarily from Earth's surface and atmosphere. The emitted radiation falls predominantly in the infrared and far-infrared portion of the electromagnetic spectrum. Earth's average temperature rises or falls to keep the total incoming and outgoing energy equal. Changes in the amount of energy entering or leaving Earth result in global warming or cooling.

tions made in the Department of Energy's atmospheric radiation program (ARM).<sup>38</sup>

Groundbased observations in DOE's ARM program also provide an important source of calibration data for space-based observations of atmospheric solar heating. Likewise, NOAA's proposed Telesonde program,<sup>39</sup> a groundbased

system integrating high-quality measurements of atmospheric winds, temperature, and moisture, would serve to calibrate satellite measurements in portions of the atmosphere in which measurements of the satellite and groundbased instruments overlap.

---

<sup>38</sup>U.S. Department of Energy, Office of Health and Environmental Research, *Atmospheric Radiation Measurement Unmanned Aerospace Vehicle and Satellite Program Plan*, March 1992 draft (Washington, DC: Department of Energy, March 1992). Also see Peter Banks et. al., *Small Satellites and RPAs in Global-Change Research*, JASON Study JSR-91-33 (McLean, VA: JASON Program Office, The MITRE Corp., July 13, 1992).

<sup>39</sup>"Management Information," Wave Propagation Laboratory, National Oceanic and Atmospheric Administration, October 1990.

# Military Uses of Civilian Remotely Sensed Data | 6

**D**ata from civilian satellites systems such as Landsat, but more notably SPOT and the Russian Almaz,<sup>1</sup> have considerable military utility. They can be used to SUPPORT:

- *Military operations*—For example, the use of Landsat and SPOT data gave the United States and its U.N. allies a marked advantage over Iraq in the Persian Gulf Conflict. The U.S. Defense Mapping Agency used these data to create a variety of maps for the U.S.-led battle against Iraqi forces (figure 6-1). More recently, in March 1993, the United States has used Landsat and SPOT data to create maps of the former Yugoslavia in support of air delivery of food and medical supplies to besieged towns of Eastern Bosnia.
- *Reconnaissance*—The recent use of data from civilian satellites for military reconnaissance demonstrates that post-processing, skilled interpretation, and the use of collateral information can make these data highly informative. For this reason, the civilian satellites' utility in reconnaissance exceeds that which might be expected on the basis of ground resolution.<sup>2</sup> The highly conservative rules of thumb normally used to relate ground resolution to suitability for particular reconnaissance tasks underestimate the utility of moderate resolution multispectral imagery.

**However, reconnaissance missions' requirements for timeliness often exceed the current capabilities of civil-**

---

<sup>1</sup> In October 1992, Almaz, which had been transmitting data from its synthetic aperture radar, fell back into the atmosphere and burned up.

<sup>2</sup> Ground resolution is a useful but simplistic measure of the capability to identify objects from high altitude.

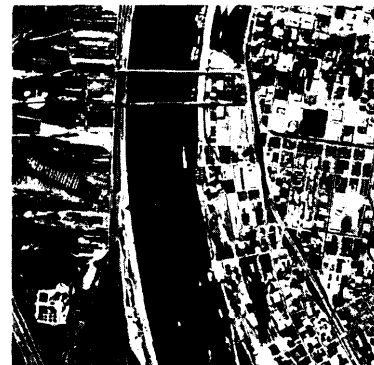

Figure 6-1—Bomb Damage Assessment of Baghdad During the Persian Gulf Conflict



Although these SPOT images of downtown Baghdad, Iraq, have sufficient ground resolution (10 m) to distinguish intact bridges (left) from damaged ones (right), SPOT's usual timeliness would be inadequate for many bomb damage assessment tasks.

SOURCE: Copyright 1993, CNES. Provided by SPOT Image Corp., Reston, VA.

**ian satellite systems.** Landsat satellites pass over any given place along the equator once every 16 days; SPOT passes over once every 26 days. In addition, both systems may take weeks to process orders and military data users generally require much shorter response times. Because civilian missions generally have less stringent requirements than military ones, civilian satellite systems will continue to fall short in this regard unless they begin to cater expressly to the military market or improve revisit time for other reasons, such as crop monitoring or disaster tracking. As noted in chapter 4, one way to increase timeliness without adding additional satellites is to provide sensors with the capability of pointing to the side. SPOT has the capacity for cross-track imaging, and can reimage targets of interest in 1 to 4 days.

. *Arms Control*—Civilian satellite data have limited, but important utility for supporting arms control agreements. Although some facilities have been imaged by civilian satellites, many other arms-control tasks are beyond the capabilities (particularly resolution) of civilian satellites. Their greatest

weakness in most military applications—lack of timely response—is of less concern in the arms control arena, where events are typically paced by diplomatic, not military, maneuvers.

- **Mapping**—Mapping, including precise measurement of the geoid<sup>3</sup> itself, is a civilian mission with important military applications. These include simulation, training, and the guidance of automated weapons. Existing civilian satellite data are not adequate to create maps with the coverage or precision desired for military use. The military use of data from civilian land remote sensing satellites **would be greatly enhanced by improved resolution, true stereo capabilities, and improved orbital location and attitude of the satellite. Military map makers and planners would also find use for data acquired with a civilian synthetic aperture radar system, which can sense Earth's surface through layers of clouds.**

<sup>3</sup>The **figure** of the solid Earth.

### Box 6-A—The Broadening of Access to Military Information

The commercial availability of militarily useful remotely sensed imagery has sparked the interest of many interested in military affairs. Landsat and SPOT images have appeared in the media, and have been used to support news stories about military action or potentially threatening behavior (plate 10).<sup>1</sup>

Individuals who have used these images to make significant deductions regarding military activity include Johnny Skorve, whose photographic explorations of the Kola Peninsula using SPOT and Landsat images fill two volumes; Bhupendra Jasani, who has used SPOT data of the territory of the former Soviet Union to investigate military questions including INF Treaty compliance (plates 11 & 12), and reporters for several news organizations. These efforts have shown that the resolution provided by SPOT and Landsat, while poor compared to the rule-of-thumb requirements often stated for some military tasks, is more than sufficient to provide useful and even intriguing military information.

Civilians have also explored the military *use* (as distinct from utility) of civilian satellites by studying the records of SPOT Image, S.A. The corporation does not identify its customers, but its catalogue does list pictures already taken by latitude, longitude, and date. Peter Zimmerman makes a convincing case, on this basis, that SPOT has been used for military purposes.

These investigations of military matters share at least one trait in common: they do not require especially timely data. As described in appendix C, it is lack of timeliness, not of resolving power, that most limits the military use of civilian satellites.

See U.S. Congress, Office of Technology Assessment, *Commercial Newgathering from Space*, OTA-ISC-TM-40 (Washington, DC: U.S. Government Printing Office, May 1987).

SOURCE: Office of Technology Assessment, 1993.

Because other nations control some of the most capable civilian remote-imaging satellites, they could deny the United States access to some imagery for political reasons, or operate their systems in ways inimical to U.S. interests. Investment in improving U.S. technical strength in civilian remote-imaging could allay these fears. **However, attempting to stay far ahead of all other countries in every remote sensing technology could be extremely expensive, and would therefore be difficult to sustain in an environment of highly constrained budgets for space activities. From the national security perspective, staying ahead in technologies of most importance to national security interests may be enough.**

Because all countries now generally follow a nondiscriminatory data policy,<sup>4</sup> in which data

are offered to all purchasers at the same price and delivery schedule, foreign belligerents can buy Landsat data to further their wars against each other. These data, coupled with information from the Global Positioning System (GPS), might even be used to prepare for a war (or terrorism) against the United States or its allies. As technical progress continues to improve spatial and spectral resolution, the military utility of successive generations of civilian remote sensing satellites will also improve. Although such uses of satellite data **may pose some risk to the United States or its allies, the economic and political benefits of open availability of data generally outweigh the risks.**

The wide availability of satellite imagery of moderate resolution, and inexpensive computer tools to analyze these images, broadens the

<sup>4</sup>This principle was originated by the United States when it decided to sell Landsat data on this basis. See U.S. Congress, Office of Technology Assessment, *Remote Sensing and the Private Sector*, OTA-ISC-TM-239 (Washington, DC: U.S. Government Printing Office, April 1984) for a discussion of the relationship of the U.S. nondiscriminatory data policy to the "Open Skies" principle.

## 84 | Remote Sensing From Space

number and types of institutions and individuals with access to information about secret sites and facilities (box 6-A). Such information contributes to a widening of the terms of the political debate over future military policies in the United States and elsewhere.

Because the military value of remotely sensed data lies in timely delivery, the United States could cut off access to data as soon as the

countries' belligerent status is made clear, as in the Persian Gulf Conflict where both SPOT Image, S. A., a French firm, and EOSAT, Inc., cut off data to Iraq. In that case, the French were part of the allied team opposing Iraq. However, the United States and France (or another country that operates a remote sensing system capable of being used for military purposes) might be on opposing sides of a future dispute.

# The Role of the Private Sector 7

The United States annually invests hundreds of millions of dollars in remote sensing satellite systems and services. Some of this investment has stimulated a market for commercial products. Private industry contributes to U.S. satellite remote sensing systems in several ways. Under contract to the Federal Government, private companies build the satellites, ground stations, and distribution networks. In the case of the Landsat system, a private firm, Earth Observation Satellite Co. (EOSAT), markets data from Landsats 1 through 5 and will soon sell data from Landsat 6.<sup>1</sup> In a new financial and organizational arrangement, Orbital Sciences Corp. (OSC) plans to launch<sup>2</sup> and operate the SeaStar remote sensing satellite, which will carry a sensor capable of monitoring the color of the ocean surface. Among other ocean attributes, ocean color data indicate ocean currents, fertile fishing grounds, and ocean health. OSC will sell the data generated by this sensor to an assortment of customers, including the Federal Government.<sup>3</sup> Finally, the remote sensing *value-added sector* develops useful information from the raw data supplied by aircraft, satellite, and other sources, and sells the resulting information to a wide variety of users.

The value-added sector is part of a much larger information industry that employs geographic information systems (GIS) and other tools to turn raw data from satellites, aircraft, and other sources into useful information. Industry products include maps;



<sup>1</sup> Landsat 4 and 5 are currently operating. Landsat 6 will be launched in mid 1993.

<sup>2</sup> OSC plans to launch SeaStar in the third quarter of 1993 on a Pegasus launch vehicle and expects to begin full satellite operations in early 1994.

<sup>3</sup> Through NASA, which is acting as an anchor tenant for the arrangement.

inventories of crops, forests, and other renewable resources; and assessments of urban growth, cultural resources, and nonrenewable resources. According to market estimates, sales of data, hardware, and software currently total about \$2 billion annually.<sup>4</sup> GIS hardware and software have the unique advantage of being able to handle spatial data in many different formats and to integrate them into usable computer files. For the next several years, at least, the private sector is **likely to derive greater profits from the provision of value-added services than from owning and/or operating remote sensing satellites. Private firms will also likely continue to be a source of improved methods of accessing, handling, and analyzing data.**

Improved market prospects for the sales of land remote sensing data will depend directly on the continued development of faster, more capable, and cheaper processing systems. In addition, the continued improvement of GIS software and hardware will make remotely sensed data accessible to a wider audience. In turn, the growth of the GIS industry will be aided by the development of the use of remotely sensed land data, including the extensive archives of unenhanced Landsat data that are maintained by the U.S. Geological Survey Earth Resources Observation Systems (U. S.G.S. EROS) Data Center, Sioux Falls, South Dakota.<sup>5</sup> OTA will assess the prospects for enhancing the private sector involvement in remote sensing in two forthcoming reports.

Despite professed interest among private entrepreneurs in building and operating land remote sensing satellites systems,<sup>6</sup> the high systems costs and the lack of a clearly defined market for

remotely sensed data have inhibited private offerors.<sup>7</sup> For example, although EOSAT has streamlined the operations and data distribution system of Landsat, and achieved sufficient income to continue its efforts without government support, projected increases in revenues from data sales do not appear sufficient to enable a system operator to finance the construction and operation of the Landsat system. Despite several technological advancements since the 1970s when the National Aeronautics and Space Administration (NASA) launched the first Landsat satellites, Landsat system costs have remained high. The Landsat 6 satellite cost about \$320 million to build. Landsat 7, which improves on the sensors of Landsat 6, will cost between \$440 and \$640 million to build, depending on whether or not it will carry the High Resolution MultiSpectral Stereo Imager (HRMSI) desired by the Department of Defense (DoD) and NASA.

Future commercialization efforts will depend on whether firms can raise sufficient private and/or public funding to pay for a system that is privately developed and operated. **The future viability of a private remote sensing system will depend on drastically reducing the costs of a satellite system through technology development and/or dramatic market growth. It may also rest on allowing private operators to determine their own data pricing policies.**<sup>8</sup>

Since it launched the first civilian remote sensing satellite in 1960, in support of the principles of "open skies" and free flow of information, the United States has followed a policy of making remotely sensed data available on a nondiscriminatory basis to potential custom-

<sup>4</sup> "GIS Markets and Opportunities, 1991," Daratech, Cambridge, MA, 1991.

<sup>5</sup> The EROS data center archive contains some 210,000 multispectral Thematic Mapper scenes gathered from around the globe since 1982.

<sup>6</sup> See, for example, U.S. Congress, Office of Technology Assessment *Commercial Newsgathering from Space, OTA-TM-ISC-40* (Washington DC: U.S. Government printing Office, May 1987).

<sup>7</sup> However, private companies have invested in less costly aircraft systems. For example, Texaco, Inc. recently embarked on a major program to develop a multiband aircraft imaging system for environmental analyses and spill detection.

<sup>8</sup> U.S. Congress, Office of Technology Assessment, *Remotely Sensed Data from Space: Distribution, Pricing, and Applications* (Washington DC: Office of Technology Assessment, July 1992).



ers — in other words, on terms that are the same to all customers.<sup>9</sup> The Land Remote Sensing Policy Act of 1992 retains nondiscriminatory data availability<sup>10</sup> for government-supported systems, but it gives authority to the Secretary of Commerce to license firms who wish to launch and operate privately funded systems. These firms may offer data on their own terms,<sup>11</sup> provided they have not received funding from the U.S. Government to acquire their systems. In January 1993, the Department of Commerce (DOC) granted the first commercial remote sensing license to WorldView Imaging Corp. of Livermore, California. The license allows WorldView to operate a pair of multispectral imaging satellites in low Earth orbit. WorldView expects to launch its satellites, which are designed to gather panchromatic data of 3 m resolution, in a few years.<sup>12</sup> On June 10, 1993, Lockheed Corp. announced that it filed with DOC for a license to operate a satellite system capable of 1 m resolution (panchromatic).<sup>13</sup>

The greatest problem private industry faces in developing and operating a remote sensing system is the difficulty of obtaining sufficient private capital to finance the venture. The Federal Government is the largest customer for land remote sensing data. If private industry were able to count on sufficient sales of data to the government for its needs, the financial markets might be more willing to finance a remote sensing system. Therefore, if Congress wishes to encourage the development of a private satellite industry that builds and operates remote sensing satellites, it could direct Federal agencies to contract for

**the provision of data from a privately owned and operated satellite system, or systems, rather than contract for the construction of a system to be owned by the government.**

Such an approach would give greater discretion to private industry to use its innovative powers to solve technical problems. It might also involve greater technical and financial risk, both to the government and to private firms, than one in which the private sector acts solely as contractor to the government.<sup>14</sup> In the long run, encouraging industry to take greater responsibility for the provision of remotely sensed data may also lead to wider data use, as industry would then be encouraged to find new uses for the data. The experiment with OSC's SeaStar satellite system should provide useful insights for the development of future privately owned satellite systems. NASA contracted with OSC to provide a specified quantity of data from the SeaWiFS sensor aboard SeaStar for a specified price. The arrangement allows NASA to provide some funding (\$43.5 million) up front that OSC has been able to use in developing the sensor and satellite. More important, NASA anchor tenant agreement with OSC also allowed the company to secure needed additional funding from the private financial market. If this arrangement proves successful, it might pave the way for similar agreements for data from larger, more complicated satellites.

In addition, **Congress might wish to explore the option of funding a research program specifically designed to reduce the costs of remote sensing systems; cost reduction would take precedence over providing greater capa-**

<sup>9</sup> U.S. Congress, Office of Technology Assessment, *Remote Sensing and the Private Sector, OTA-ISC-TM-239* (Washington, DC: U.S. Government Printing Office, April 1984), p. 7.

<sup>10</sup> Ibid.

<sup>11</sup> They may, for example, elect to charge higher prices for more timely delivery of data, or, for an additional fee, grant exclusive access to certain data for a specified period.

<sup>12</sup> U.S. Department of Commerce News Release, Jan. 28, 1993.

<sup>13</sup> Leonard David, "Plans to Market Spy-Quality Imagery," *Space News*, June 14, 1993.

<sup>14</sup> As noted earlier in this report, systems paid for solely by the Federal Government, of course, also sustain budget, technical, and programmatic risks.

**bility.** It might, for example, wish to fund, on a competitive basis, the private development of sensors and small satellite buses specifically designed to reduce costs. Although such innovative programs involve greater risk than the usual way government procures new technology, as the development of amateur communications satellites has demonstrated, they also have a potentially high payoff in increased provision of inexpensive services.<sup>15</sup> Among other **things**, an innovative program to reduce sensor and satellite costs, or to provide increased capability, might introduce greater competition into the development of remote sensing satellite systems.

The government might also wish to involve the private sector in global change research by sharing data sets with private industry for re-

search purposes. In a 1992 report, the Geosat Committee pointed out that the oil, gas, and mineral extraction industry is heavily involved in performing research on the environment in connection with its profit-making interests. The Geosat Committee proposed to institute pilot programs that would involve both private industry and the government in a research partnership, in which the government could gain useful global change information, and private industry would gain access to a wide variety of data to support its research interests.<sup>16</sup> Such research programs, in which the government and the private sector join forces in partnership, could enhance the significance of remotely sensed data for global change and even lead to innovative new methods for using them.

---

<sup>15</sup> Amateur radio operators have built and launched several small, low-cost, low-orbit communications satellites. See U.S. Congress, Office of Technology Assessment, *Affordable Spacecraft: Design and Launch Alternatives*, OTA-TM-ISC-60 (Washington DC: U.S. Government Printing Office, September 1990), pp. 19-20.

<sup>16</sup> The Geosat Committee, Inc., "Applying Resource Industry's Research to the U.S. Global Change Research Program," Norman, OK, 1992.

# International Cooperation and Competition

# 8

**T**he European Space Agency (ESA) and the governments of China, France, India, Japan, and Russia each operate remote sensing systems to study Earth's surface.<sup>1</sup> Canada will join this group in 1995 when it launches Radarsat, a system optimized to monitor ice conditions, especially in the northern hemisphere. Europe, Japan, and Russia operate satellite systems designed to gather weather and climate data. In many cases, data from these systems complement U.S. data. In others, they overlap them. The many non-U.S. remote sensing systems either planned or in operation raise concerns of competition and cooperation for the United States. Until recently, the United States led the world in all areas of remote sensing from space. Now other countries compete with the United States for the small but growing commercial market in remotely sensed data. For example, SPOT Image, S.A., has been selling data from the French SPOT satellite since 1987. Other countries also compete with the United States for scientific and technological kudos.

## INCREASED INTERNATIONAL COOPERATION IN EARTH MONITORING AND GLOBAL CHANGE RESEARCH

The experience of Canada, ESA, France, Japan, and Russia with remote sensing technology and data handling suggests that they would make effective partners in cooperative satellite and data programs. Indeed, as noted earlier in this report, the United States plays an active part in cooperative activities to gather and distribute meteorological data (box 8-A). It also cooperates

---

<sup>1</sup> See app. D for a summary of each country's remote sensing activities.

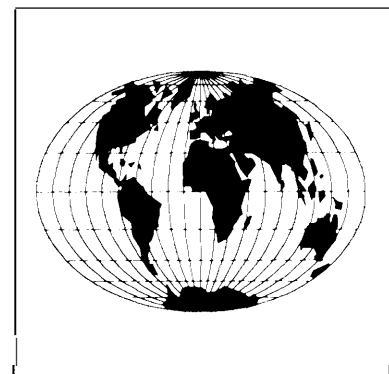

### Box 8-A-international Cooperation in Weather Monitoring

International cooperation in meteorological satellites has a long, successful history.<sup>1</sup> The U.N. World Meteorological Organization (WMO), founded in 1951, can trace its roots to the International Meteorological Organization, which was established in 1853. The WMO is a planning and coordinating body with basic programs to help all countries cooperatively produce and obtain important meteorological data.

Extensive cooperation is evident between the United States and many European countries. As noted, the United States has excellent working relations with Eumetsat and now relies on a Eumetsat weather satellite to augment coverage of the remaining geostationary operational environmental satellites (GOES) platform; the United States had previously made excess GOES weather **monitoring capability available to Europe**.

Although international cooperation can reduce costs to each party, there are limits on the extent of cooperation that is infeasible. For example, weather patterns and the nature of severe storms in the United States are different than those of Europe. In the future, U.S. meteorologists are interested in obtaining simultaneous images and soundings, a capability that will provide better warning of relatively small, violent storms, such as tornados. Because the conditions that might produce small, extremely severe storms are very seldom present in Europe, Eumetsat accords lower priority to simultaneous imaging and sounding in its geostationary satellite system.

<sup>1</sup> See appendix D for a more detailed description of international cooperation in weather monitoring and other remote sensing activities.

extensively with Europe on the National Oceanic and Atmospheric Administration's (NOAA) polar orbiting satellite system, and both Europe and Japan have important roles in National Aeronautics and Space Administration's (NASA) Earth Observing System (EOS) program. In addition, the United States has worked closely with Canada on the development of Radarsat. NOAA and NASA have sought cooperative arrangements in order to reduce their program costs, but also to tap the considerable scientific and engineering expertise available in Japan and Europe. U.S. partners have similar motivations with respect to the United States.

The United States participates in the Committee on Earth Observation Systems (CEOS), created in 1984,<sup>2</sup> which coordinates existing and

planned satellite Earth observations,<sup>3</sup> and in the International Earth Observing System (IEOS), which NASA organized to coordinate the work of the international partners in EOS. In other words, these cooperative arrangements provide benefits consistent with U.S. space policy:

The United States will conduct international cooperative space-related activities that are expected to achieve sufficient scientific, political, economic, or national security benefits for the nation.<sup>4</sup>

The success of these cooperative efforts and the desire to make greater use of shared scientific and technical resources, combined with the need to find more efficient, cost-effective ways of gathering global environmental data have led to numer-

<sup>2</sup> CEOS developed out of discussions begun in 1982 at the June meeting of the Economic Summit of Industrialized Nations in which a working Group on Technology, Growth and Employment discussed cooperative efforts in satellite remote sensing. An international Panel of Experts on Remote Sensing from Space, chaired by the United States, established CEOS in 1984.

<sup>3</sup> D. Brent Smith, "International Coordination of Earth Observation From Space Activities." Paper presented at the Twenty-Third International Symposium on Remote Sensing of Environment, Bangkok, Thailand, Apr. 18-25, 1990.

<sup>4</sup> The White House, *National Space Policy*, Nov. 2, 1989, p. 2.

ous suggestions for closer international cooperation in environmental remote sensing.<sup>5</sup> Such suggestions are consonant with more general interest in enhanced international cooperation.

The end of the Cold War and the continued growth of scientific and technical competence overseas makes such cooperative arrangements much more feasible than before. Indeed, several recent reports have urged greater international cooperation in space activities than previously experienced.<sup>6</sup> However, the perceptions, habits, and institutions developed by the world during the height of the Cold War will not change quickly. In addition, as several recent reports of the Carnegie Commission on Science, Technology, and Government have noted, U.S. science and technology institutions need to be improved in order to foster more effective international collaboration.<sup>7</sup>

## INTERNATIONAL COOPERATION AND SURFACE REMOTE SENSING

Several authors have suggested that the United States should approach other countries about establishing a cooperative program in surface remote sensing.<sup>8</sup> Because both commercial considerations and government prestige and control are involved in the provision of remotely sensed

surface data, the issue of cooperation is more complicated than with strictly government-government cooperative arrangements, or with strictly commercial cooperative ventures. On the one hand, satellite system costs often exceed one-half billion dollars for a single satellite and its associated ground systems.<sup>9</sup> On the other, the existence of several systems, each generating data of somewhat different characteristics and quality, gives data purchasers a greater variety of data sources from which to choose. Yet, as a result of the high system and operations costs, data prices remain high even though they are still highly subsidized. In order to limit unnecessary redundancy by governments, reduce costs, and to promote more effective application of the data for a wide variety of data users, the United States may wish to explore the potential for working with other countries in a cooperative venture in surface remote sensing.

The existing governmental and commercial structures for multispectral land remote sensing provide a specific example of how difficult such cooperation might be to arrange. For example, the French firm SPOT Image, S.A. sells data from the French SPOT satellite in competition with the U.S. company Earth Observation Satellite Co. (EOSAT), which markets data from the U.S. Landsat satellite. In both cases, the governments

<sup>5</sup> John H. McElroy, "Intelsat, Inmarsat, and CEOS: Is Envirosat Next?" Presented at the American Institute for Aeronautics and Astronautics Workshop on International Space Cooperation: *Learning from the Past, Planning for the Future*, Hawaii, December 1992; D. Brent Smith, Linda V. Moodie, Betty A. Howard, Lisa R. Schaffer, and Peter Backlund, "Coordinating Earth Observations from Space: Toward a Global Earth Observing System" (IAF-9(L100)). Presented at the 41st Congress of the International Astronautical Federation October 1990, Dresden.

<sup>6</sup> U.S.-Crest, *Partners in Space* (Arlington, VA: U. S.-Crest, May 1993); Vice President's Space Policy Advisory Board, *A Post Cold War Assessment of U.S. Space Policy* (Washington DC: The White House, December 1992), pp. 33-38; Space Policy Institute and Association of Space Explorers, "International Cooperation in Space-New Opportunities, New Approaches: An Assessment," *Space Policy*, vol. 8, No. 3, August 1992, pp. 195-204.

<sup>7</sup> Carnegie Commission on Science Technology, and Government, *Science and Technology in U.S. International Affairs* (New York, NY: Carnegie Commission January 1992); Carnegie Commission on Science Technology, and Government *International Environmental Research and Development Research and Assessment: Proposals for Better Organization and Decision Making* (New York, NY: Carnegie Commission, July 1992).

<sup>8</sup> Neil R. Helm and Burton I. Edelson, "An International Organization for Remote Sensing" (IAF-91-112). Paper presented at the 42nd Congress of the International Astronautical Federation October 1991, Montreal, Canada; John L. McLucas and Paul M. Maughan, "The Case for Envirosat," *Space Policy*, vol. 4, No. 3, August 1988, pp. 229-239.

<sup>9</sup> DOD and NASA estimate that for Landsat 7, acquisition and operations costs over 5 years of operation will total over a billion dollars. See ch. 4.

paid for and launched the satellites. Until the Russian Almaz satellite, which carried a synthetic aperture radar (SAR), failed in October 1992, a Russian government corporation was marketing data from the government-owned and operated satellite.<sup>10</sup>

Such a cooperative venture might be tried with a system for which the commercial data markets are less well developed. For example, the United States could seek to institute a cooperative development program for a SAR system, to be used not only for global change research, but also for supporting development and resource management projects, and for a wide variety of commercial uses. The U.S. SAR, which NASA had planned to build as part of its EOS, would have been a highly sophisticated and expensive, multifrequency, multipolarization system.<sup>11</sup> Because of the cost and technical risk involved, NASA deferred development of its EOS SAR. However, because several other countries also have experience in building SAR instruments, it might be possible to construct an effective multifrequency, multipolarization SAR system in partnership with other countries. One way to do this and keep the technical and managerial interfaces relatively uncomplicated would be for each organization involved to build its own SAR satellite designed to operate at a frequency different from the others.<sup>12</sup> Each satellite could also be designed to operate at several polarizations.<sup>13</sup> If flown in adjacent orbits, these satellites would operate much like a multifrequency, multipolarization SAR on a single platform, but the cost and technical risk of each satellite would be less than for the single platform.

Under this arrangement, partners from different countries or space organizations could each contribute different space instruments, satellite platforms, or receiving systems in return for favorable data prices. Each partner could still develop expertise in several different areas, cooperating where expertise did not overlap, competing where it did. Because the scale of the investment would be so large as to require major funding from governments, who would also be the venture's primary customers, it might be possible to structure the project initially under the aegis of CEOS. If the system were technically successful, it might eventually be advantageous to house it in a more permanent administrative structure.<sup>14</sup>

## MAINTAINING A U.S. COMPETITIVE POSITION IN REMOTE SENSING

The U.S. desire to maintain a strong U.S. position in high technology products in order to contribute to its economic competitiveness and reach a more favorable balance of international trade raises the question of how the United States can bolster its technological advantage and improve its competitive market position in remote sensing technology and data products. Especially with the projected reductions in spending for defense-related technologies, the United States is disadvantaged abroad by its existing policies of generally maintaining an arms-length relationship between the government and private indus-

---

<sup>10</sup> With a resolution as fine as 7 meters, this satellite was a powerful tool for generating maps of the Earth's surface and for observing changes, despite intervening cloud cover. In the United States, Almaz data were distributed first by Space Commerce Corp., and more recently by Hughes STX Corp. For a variety of reasons, including uncertain data delivery, sales have been limited.

<sup>11</sup> NASA estimates place the cost of the NASA plan at about \$1.5 billion. See app. B for a detailed description of SAR technology.

<sup>12</sup> JPL SAR program officials, who originated this concept, suggest that three bands would be appropriate--C band, L band, and X band.

<sup>13</sup> Different polarizations provide different views of Earth's surface, depending on the material sensed. Multiple polarizations on the same instrument provide substantial additional data for analyzing surface conditions.

<sup>14</sup> McElroy, op. cit., footnote 5.

try. Other countries, most notably Canada and France,<sup>15</sup> have aggressively pursued the development of remote sensing satellite systems to monitor the land surface and oceans in concert with their private sector.<sup>16</sup>

In order to maintain and enhance U.S. capabilities in civilian remote sensing, the United States **may need to develop new forms of partnership between government and the private sector. Otherwise, the United States could be left behind in the race to develop new remote sensing technologies.** In particular, the previous chapter suggested that the U.S. government could undertake R&D programs to foster innovation in the development of sensors and satellite systems within the U.S. private sector and move toward purchases of data rather than satellite systems from the private sector.

The final report of this assessment will examine the benefits and drawbacks of international cooperative mechanisms in much more detail in the context of a strategic plan for U.S. remote sensing activities. In particular, it will explore issues such as:

- . institutional models for international cooperation in remote sensing;
- the roles of U.S. agencies, including NASA, NOAA, Department of Defense, and the Department of State;
- . the United States as a cooperative partner: successes and failures; and
- . the appropriate balance between cooperative and competitive activities.

---

<sup>15</sup> R... has also developed private companies to market remotely sensed ... with mixed ...

<sup>16</sup> When it contracted with EOSAT to market data from the Landsat series of satellites, the United States also developed a new public/private institution. However, ambivalence within the U.S. Government toward the arrangement made it extremely difficult to follow through with the arrangement.



PLATE 1

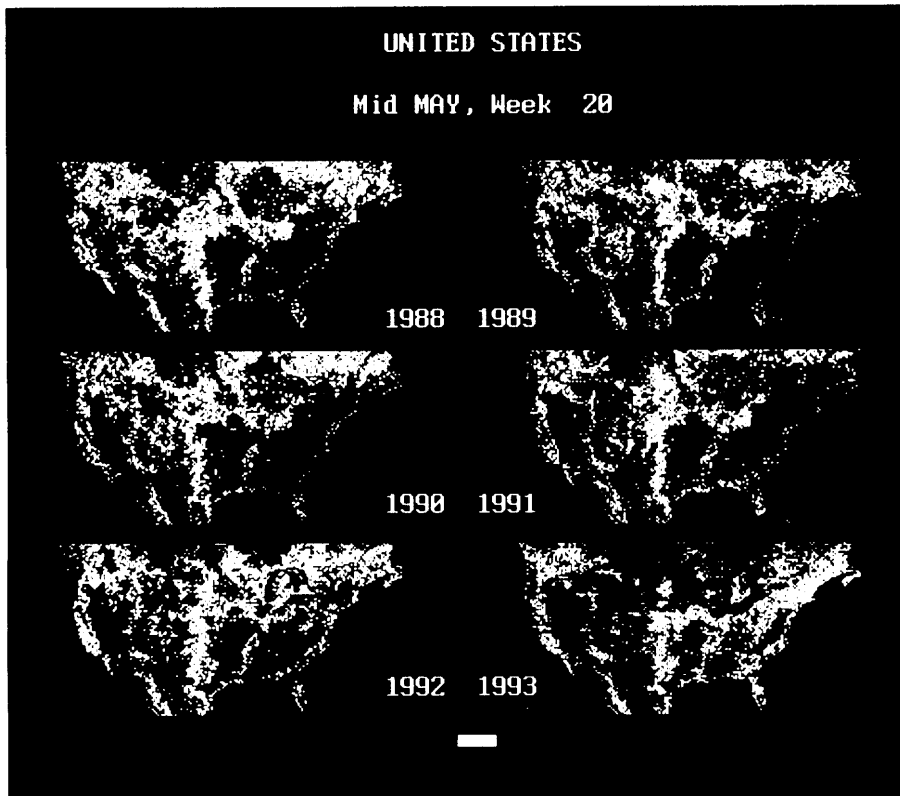

PLATE 2





PLATE 3



PLATE 4



PLATE 5

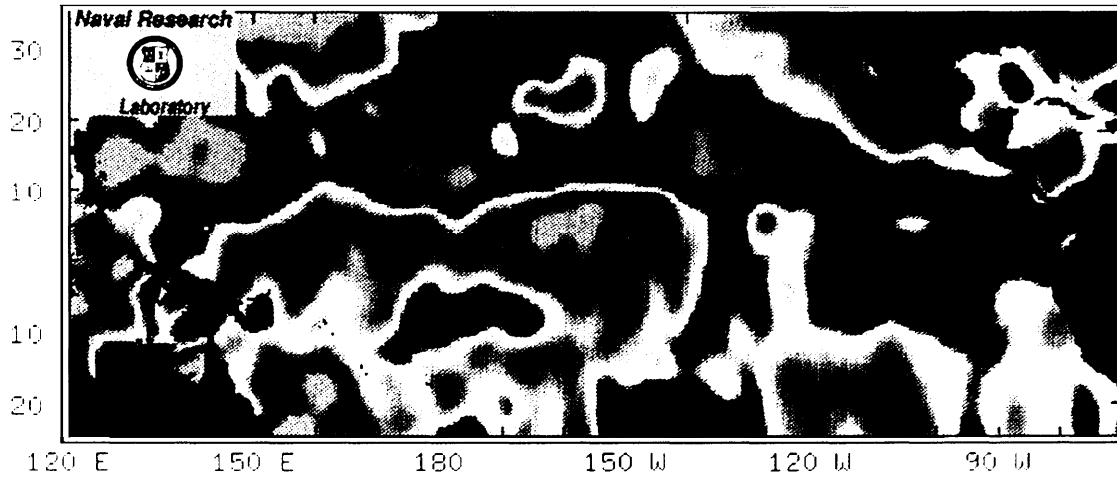

PLATE 6

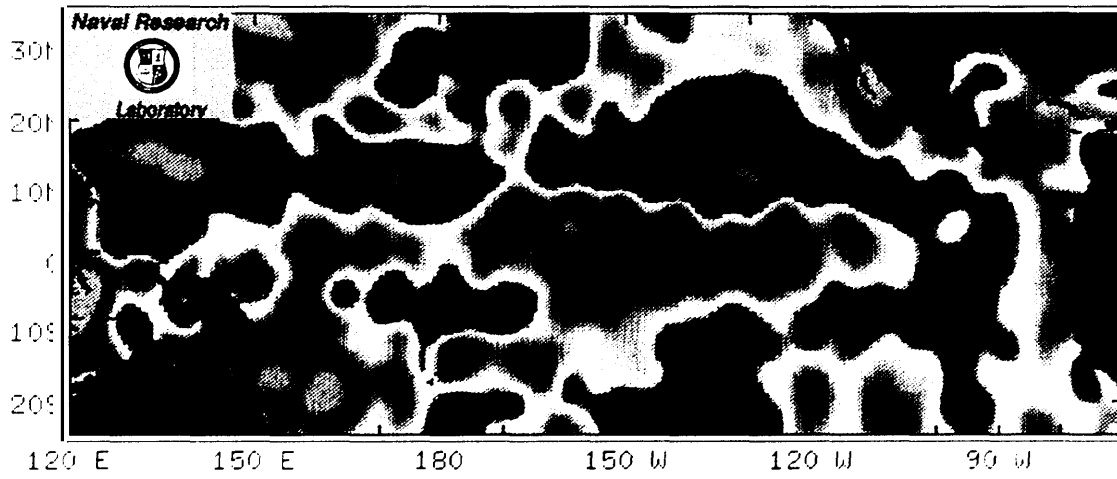

PLATE 7

November 1992



December 1992



January 1992

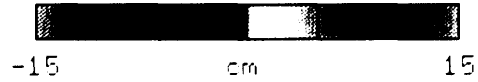
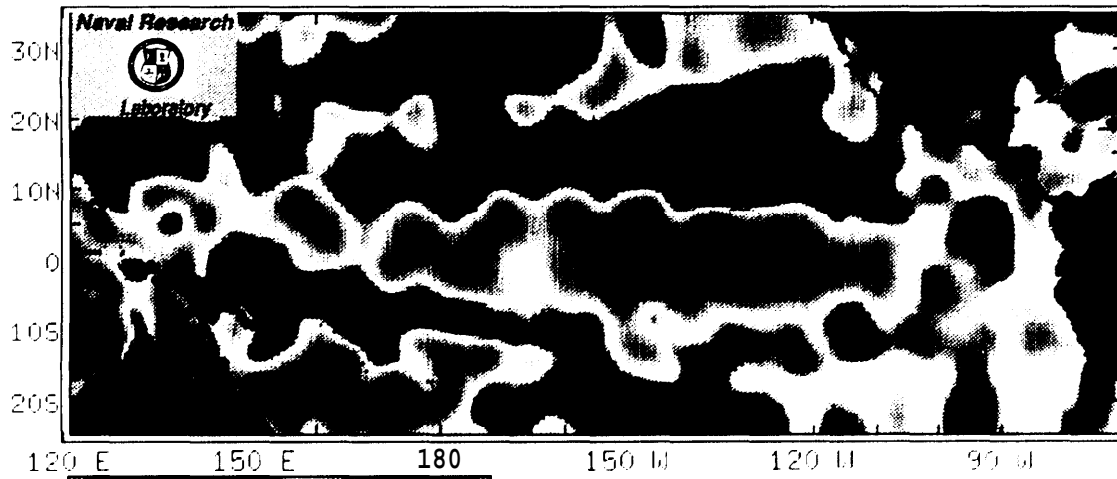

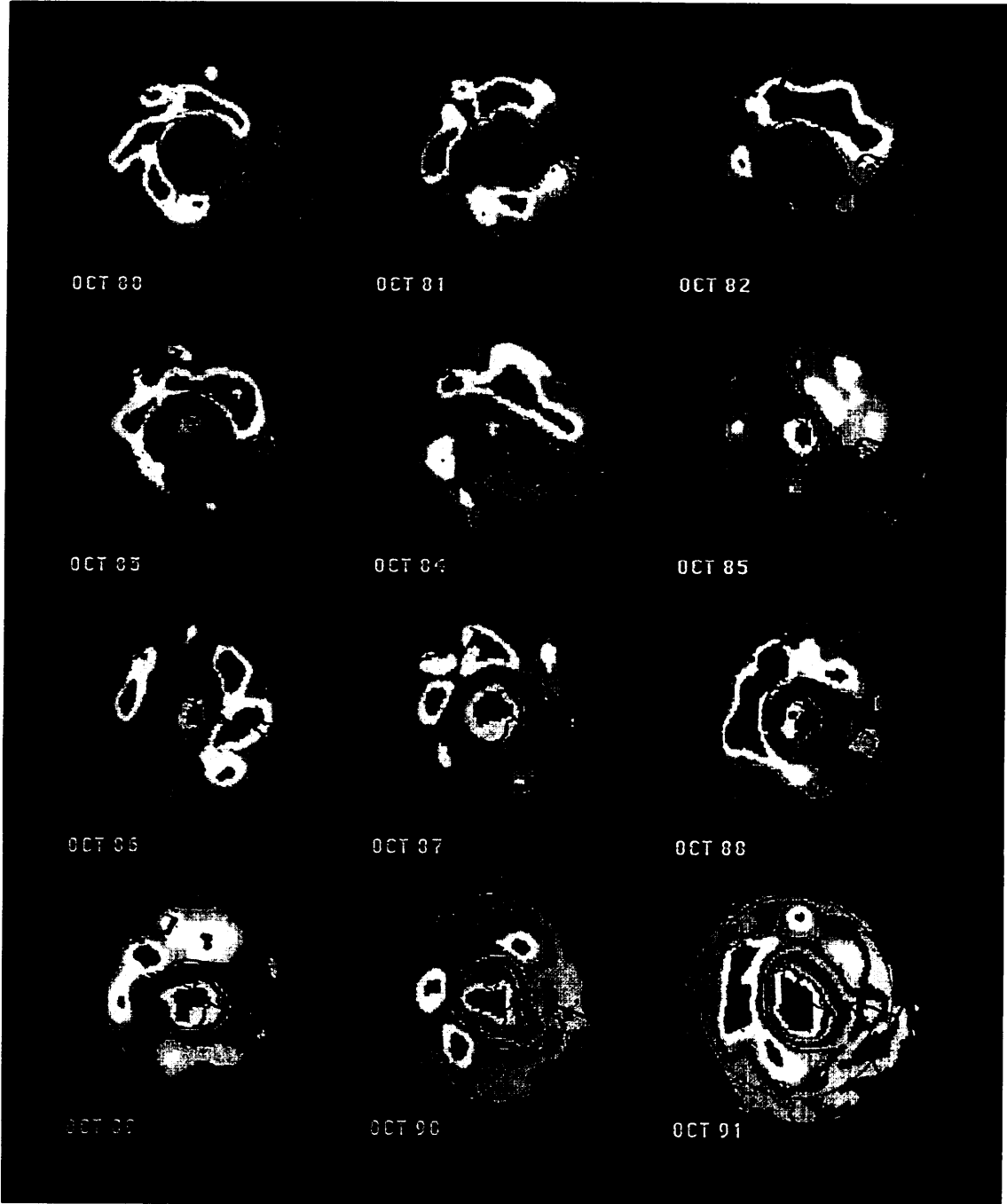

PLATE 9

*February 6, 1987*



*SPOT CI*



*March 21, 1986*



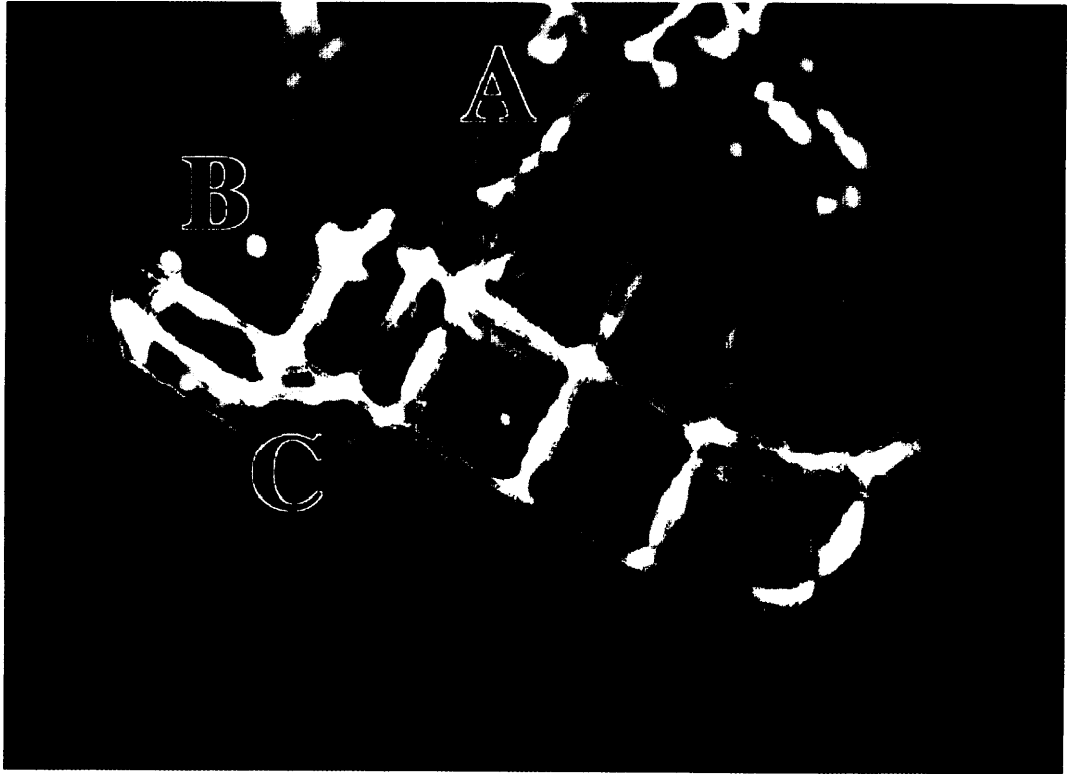

PLATE 11

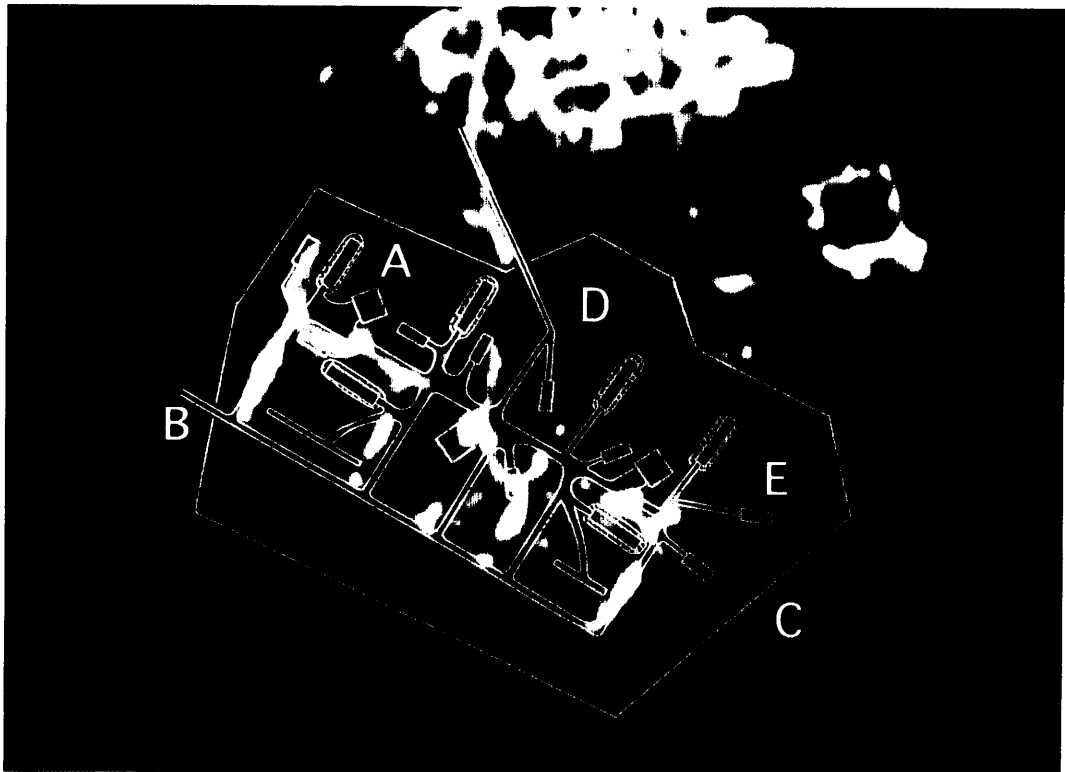

PLATE 12

# Appendix A: Research and The Earth Observing System

Until recently, meteorological applications were the primary force behind the development of civilian remote sensing systems. In the future, meteorology *and* global change research will influence the direction of remote sensing developments. Widespread attention to scientific issues regarding global change is likely to result in spending several billion dollars for sensor and spacecraft development. This appendix evaluates the relationship between planned sensors and the study of climate and environment, and reviews sensor development plans in detail.

Future remote sensing systems will provide improved recognition and understanding of environmental problems, and collect data to inform scientists and policymakers of the ramifications of a changing environment.<sup>1</sup> Future systems (such as EOS) are designed to provide a better understanding of the processes **affected by** changes in the atmosphere.<sup>2</sup> More complete data from remote sensing satellites, combined with increased opportunities to test models against reality, can improve environmental models, especially general circulation models (GCMs) of global climate.<sup>3</sup>

Remote sensing from space provides an effective way to determine the extent of environmental change. Space-based remote sensors are capable of yielding the synoptic view of global events necessary to identify and quantify changes occurring in the atmosphere and on the

---

<sup>1</sup> In addition to helping to answer questions about whether the Climate is changing, remote sensing systems are regularly used to monitor ecosystems, map wetlands, and track pollution.

<sup>2</sup> NASA's EOS program is being designed to address many of the key areas of scientific uncertainty. See the National Research Council, *The U.S. Global Change Research Program, An Assessment of FY 1991 Plans*, National Academy Press, 1990. Although EOS has been restructured since this evaluation was written most of the instruments evaluated by the study are still included in EOS.

<sup>3</sup> Effectiveness of the data from any observation system in explaining observed phenomena is determined by the way data are used.



### Box A-1-Climate Change

Many of the remote sensing systems discussed in this report are designed to provide data about the climate. The Earth's climate is determined by many factors. The primary force is radiant energy from the Sun, and the reflection or absorption and reradiation of this energy by atmospheric gas molecules, clouds, and the surface of the Earth itself (including forests, mountains, ice sheets, and urban areas). A portion of the reradiated energy leaves the atmosphere. Over the long term, balance is maintained between the solar energy entering the atmosphere and energy leaving it. Within this balance, interactions among the atmosphere, snow and ice, oceans, biomass, and land cause variations in global and local climate. For example, El Niño, the large-scale warming of the tropical Pacific that occurs periodically, is apparently the result of complex interactions between the ocean and atmosphere.<sup>1</sup>

A region's general climate is defined by aggregate weather patterns—for example, snowfall, predominant wind direction, summertime high temperature, precipitation—averaged over several decades or longer. These patterns can vary substantially from one year to another in a given area. The mean annual temperature of the United States, for example, can differ by 0.5 to 1.5 °C. When scientists discuss climate *change*, they are generally referring to trends that persist for decades or even centuries, over and above natural seasonal and annual fluctuations. One type of change arises from forces that are external to the Earth's climate system. The ice ages and glacial-interglacial cycles, for example, are thought to have been triggered by changes in the seasonal and geographical distributions of solar energy entering the Earth's atmosphere associated with asymmetries in the Earth's orbit around the Sun. Also, major volcanic eruptions can deposit aerosols (e.g., sulfate particles) into the stratosphere, partially blocking or screening sunlight from reaching the surface of the Earth and thus temporarily cooling the Earth's surface. Variations in volcanic activity (1992 was cooler than normal in many parts of North America, in all likelihood because of the eruptions of Mt. Pinatubo), ice sheets, forest cover, marine phytoplankton populations, and/or ocean circulation, among other factors, may have interacted with solar variability (including changes in the Sun's brightness) to determine the Earth's past temperature record.<sup>2</sup>

Other changes to the climate can be linked to human activity. Fossil fuel emissions and the release of compounds such as chlorofluorocarbons have changed the makeup of the atmosphere. To what extent human activity has contributed to changes in atmosphere and how these changes affect the climate is not clear.

<sup>1</sup>G.A. Meehl, "Seasonal Cycle Forcing of El Niño—Southern Oscillation in a Global Coupled Ocean-Atmosphere GCM," *Journal of Climate* 3:72-98, 1990.

<sup>2</sup>See s. Baliunas, and R. Jastrow, "Evidence for Long-Twin Brightness Changes of Solar-Type Stars," *Nature* 348:520-522, 1990; W.S. Broecker, "Unpleasant Surprises in the Greenhouse?" *Nature* 328:123-126, 1987; R.A. Bryson, "Late Quaternary Volcanic Modulation of Milankovitch Climate Forcing," *Theoretical and Applied Climatology* 39:115-125, 1989.

SOURCE: Adapted From U.S. Congress, Office of Technology Assessment, *Changing by Degrees: Steps to Reduce Greenhouse Gases*, OTA-O-482 (Washington, DC: U.S. Government Printing Office, February 1991).

surface. Global viewing is critical to understanding geophysical processes, since many seemingly isolated events are parts of a whole. As a result of growing catalogues of data, better quantitative models that simultaneously consider ocean and atmosphere have grown in sophistication.<sup>4</sup>

### | Remote Sensing and the Current State of Climate Research

Is there evidence of climate change (box A-1)? What are the implications of variations in temperature, rainfall, cloud cover, polar ice and sea level? These questions spark controversy among climatologists, biologists, economists, and politicians. Differences in

<sup>4</sup>Thomas F. Malone, "Mission to Planet Earth," *Environment*, vol. 28, October 1986, p.6.

opinion often derive from large uncertainties in data, imperfect numerical models, and assumptions that drive predictive models. For example, climate data show evidence of a slow but steady increase in global temperature, and glacial records indicate higher levels of CO<sub>2</sub> and other gases than at any other time since the ice age. Yet future trends and consequences of continued climate and environmental change are highly uncertain. Remote sensing systems are essential if researchers are to assemble a comprehensive picture of global processes.

The study of global change, much like the study of meteorology, encompasses the effects of many earth processes.<sup>5</sup> Scientific uncertainty manifests itself as wide variations in general circulation models used to predict climate change and understand the human impact on the environment. Key elements of uncertainty in developing predictive models include:

- clouds, primarily cloud formation, dissipation, and radiative properties, which influence the response of the atmosphere to greenhouse forcing;
- **oceans**, the exchange of energy between the ocean and the atmosphere, between the upper layers of the ocean and the deep ocean, and transport within the ocean, all of which control the rate of global change and the patterns of regional change;
- **greenhouse gases**, quantification of the uptake and release of the greenhouse gases, their chemical reactions in the atmosphere, and how these may be influenced by climate change; and
- **polar ice sheets**, which affect sea level rise.<sup>6</sup>

General circulation models are complex computer models of the climate system that quantify the interaction of various elements of the environment, allowing researchers to develop hypotheses regarding the climate and elements of change. Uncertainties in GCMS can be reduced in two ways: first, improve the data used in GCMS; second, rigorously test predicted results against real events to improve the models themselves.

Plans for future remote sensing satellite systems call for the development of a number of sensors to obtain data that will improve scientists' understanding of clouds, oceans, and atmosphere. These data, which will be used in GCMS and other models, should improve the ability of scientists to understand the interaction of systems and reduce some of the current uncertainty.<sup>7</sup>

Uncertainties regarding climate change abound, yet substantial evidence exists that environmental change has already taken place. According to many climatologists, human activity is altering the climate system beyond the limits of natural rates of change experienced by the Earth over the last hundreds of thousands of years.<sup>8</sup> Human activity is dramatically changing the chemical makeup of the Earth's atmosphere. Atmospheric concentrations of several "greenhouse gases," which trap heat in the atmosphere, naturally keeping the earth at a habitable temperature, have risen rapidly over the last 100 years, (box A-2) and according to some, have contributed to increased average temperatures.<sup>9</sup> Most of these gases (carbon dioxide, methane, and nitrous oxide) occur naturally, but their rapid increase results mainly from human activity. For example, the atmospheric concentration of carbon dioxide is currently increasing about 30 to 100 times faster than the rate of natural fluctuations found in ice

<sup>5</sup> Ibid, p. 6.

<sup>6</sup> Intergovernmental Panel on Climate Change, *Scientific Assessment of Climate Change*, World Meteorological Organization, 1990, p. xxxi.

<sup>7</sup> Data detailing changes in land surface hydrology, solar radiation cycle, characteristics of surface albedo, the role of atmospheric and surface winds, amount and health of biomass, and changes in land features will also play a large role in understanding climate and environmental change.

<sup>8</sup> R.A. Berner, 'Atmospheric Carbon Dioxide Levels Over Phanerozoic Time,' *Science* 249: 1382-1386, 1990; IPCC, op. cit.; C. Lorius, et al., "The Ice-Core Record: Climate Sensitivity and Future Greenhouse Warming," *Nature* 347: 139-145, 1990.

<sup>9</sup> According to climate models in use today, increases of 0.3 to 1.1 C should have occurred over the past 100 years as a result of increased atmospheric concentrations of greenhouse gases. Natural climate variability and other factors (measurement errors, urban heat island effects, etc.) confound detection of almost any climate trends, however. The Intergovernmental Panel on Climate Change, or IPCC—a group of several hundred scientists from 25 countries, described below—concluded that the global temperature record over this period indicates that the Earth actually has warmed by about 0.45 C, which is within the range of estimates. Yet the findings of the WCC, while representing the views of many atmospheric scientists, are not universally accepted.

### Box A-2-Global Warming and the Greenhouse Effect

Emissions of greenhouse gases constitute a new force for climate research (in addition to the natural climatic phenomena). Because of natural variability in climate, the IPCC concluded that the observed 20th-century warming trend would have to continue for one to two more decades before it can be unambiguously attributed to enhanced greenhouse gases.<sup>1</sup>

About 30 percent of the solar radiation reaching the Earth is reflected by the atmosphere and Earth back to space, and the remainder is absorbed by the atmosphere, ice, oceans, land, and biomass of Earth. The Earth then emits long-wave radiation in the infrared and microwave wavelengths, which is partially absorbed and "trapped" by atmospheric gases.<sup>2</sup> The result of these natural processes is the "greenhouse" effect- warming of the Earth's atmosphere and surface. Without the natural heat trap of these atmospheric gases, Earth's surface temperatures would be about 33 °C (60 °F) colder than present.<sup>3</sup> Human activities during the last century have resulted in substantial increases in the atmospheric concentrations of CO<sub>2</sub>, CH<sub>4</sub>, and N<sub>2</sub>O.<sup>4</sup> As concentrations of these gases increase, more radiation should be trapped to warm the Earth's surface and atmosphere. However, as more heat is trapped and the Earth and atmosphere warm, more thermal radiation should be emitted back to space, eventually restoring the energy balance or equilibrium, but leaving a warmer climate.<sup>5</sup>

The basic "heat trapping" property of greenhouse gases is essentially undisputed. However, considerable scientific uncertainty remains about how and when Earth's climate will respond to enhanced greenhouse gases. The more uncertain aspects of climate response include: climate feedbacks that will help determine the ultimate magnitude of temperature change (i.e., "equilibrium" warming); the role of the **oceans in setting the pace of warming; and other climate changes that might** accompany warming and how specific regions of the world might be affected. Planned remote sensing systems such as the Earth Observing System platforms will carry sensors that will measure these aspects of climate variability.

Predictions of future warming are highly uncertain, because of the inaccuracies of climate models themselves and varying projections for future greenhouse gas emissions levels. Future emissions will be tied to population and economic growth, technological developments, and government policies, all of which are difficult to project.

To avoid the pitfalls and complexity of estimating future emissions, and to provide a common basis for comparing different models or assumptions, climate modelers typically examine climates associated with preindustrial levels of atmospheric CO<sub>2</sub> concentration. These are compared to "equilibrium" climate- i.e., when

<sup>1</sup> Intergovernmental Panel on Global Change, *Scientific Assessment of Climate Change*, World Meteorological Organization, 1990.

<sup>2</sup> See: Dickinson, R.E. and R.J. Cicerone, "Future Global Warming From Atmospheric Trace Gases," *Nature* 319:109-115, 1936; Lindzen, R. S., "Some Coolness Concerning Global Warming," *Bulletin of the American Meteorological Society* 71 :288-290, 1990.

<sup>3</sup> At 60 °F (33 °C) cooler than at present, life as we know it today on Earth would not be possible. Water vapor (in the form of clouds) and carbon dioxide (CO<sub>2</sub>) are the major contributors to this effect, with smaller but still significant contributions from other trace gases, such as methane (CH<sub>4</sub>), nitrous oxide (N<sub>2</sub>O), and ozone (O<sub>3</sub>).

<sup>4</sup> One must also consider the introduction and rapid increase of the synthetic chlorofluorocarbons (CFCs), which contribute to the destruction of atmospheric ozone (O<sub>3</sub>), which absorbs incoming ultraviolet radiation >320 nm. Without this "filter," we will see an increase in illness and habitat destruction due to ultraviolet energy.

<sup>5</sup> The uncertainty of warming forecasts is twofold: how much warming will occur; and what happens after small amounts of warming? The first is self-explanatory, the second a captivating scientific debate. Will increased temperatures cause more suspended water vapor (clouds) reflecting more energy and restoring current temperatures? Will severe storms become more common?

the climate system has fully responded and is in equilibrium with a given level of radiative forcing<sup>6</sup> associated with double those levels. Although such “sensitivity analyses” provide useful benchmarks, they are unrealistic in that they *instantaneously* double CO<sub>2</sub> concentrations, rather than increase them gradually overtime. In the last few years, scientists have intensified research using more realistic “transient” climate models where CO<sub>2</sub> increases incrementally over time.<sup>7</sup>

Many models indicate that a range of 1.5 to 4.5 °C (3 to 8 °F) bounds the anticipated equilibrium warming, likely in response to a doubling of CO<sub>2</sub> from preindustrial levels.<sup>8</sup> Uncertainty about the actual figure is primarily due to uncertainty about feedbacks—processes that occur in response to initial warming and act either to amplify or dampen the ultimate equilibrium response. The lower end of the range (1.5 °C change) roughly corresponds to the direct impact of heat trapping associated with doubled CO<sub>2</sub>, with little amplification from feedbacks. The upper end of the range (4.5 °C) accounts for feedback processes that roughly triple the direct heat-trapping effect. Hypothesized feedbacks that could release extra CH<sub>4</sub> and CO<sub>2</sub> into the atmosphere are not included in present models,<sup>9</sup> so warming could be even more severe. On the other hand, clouds may block much more solar radiation than models presently assume and thereby reduce the warming.

A 1.5 to 4.5 °C warming bounds model predictions of warming in response to this reference or benchmark CO<sub>2</sub> level. Higher or lower CO<sub>2</sub> concentrations (or a combination of greenhouse gas levels) might lead to greater or less warming. The IPCC “business as usual” emissions scenario projects a global mean temperature increase above today’s level of about .25°C (0.54 °F) per decade, or an increase of roughly 1.0°C (2.2 °F) by 2030 and 3.1 °C (6.6 °F) by 2100.

<sup>6</sup> Change in temperature or climate caused by changes in solar radiation levels.

<sup>7</sup> IPCC; Washington, W.M. and G.A. Meehl, “Climate Sensitivity Due to Increased CO<sub>2</sub>: Expedients With A Coupled Atmosphere and Ocean General Circulation Model,” *Climate Dynamics* 4:1 38, 1989.

<sup>8</sup> IPCC; Stouffer, R.J., S. Manabe, and J. Bryan, “Interhemispheric Asymmetry in Climate Response to a Gradual Increase of Atmospheric Carbon Dioxide,” *Nature* 342:660-662, 1989; J. Hansen et al., “Global Climate Changes as Forecast by the Goddard Institute for Space Studies Three-Dimensional Model,” *J. Geophysical Research*, 93:9341-9364, 1988.

<sup>9</sup> IPCC; Lashof, D., “The Dynamic Greenhouse: Feedback Processes that May Influence Future Concentrations of Atmospheric Trace Gases and Climatic Change,” *Climatic Change* 14:213-242, 1989.

SOURCE: Adapted from U.S. Congress, Office of Technology Assessment, *Changing by Degrees: Steps to Reduce Greenhouse Gases* (Washington, DC: U.S. Government Printing Office, February 1991).

core samples; 10 concentrations are already 25 percent above average interglacial levels and 75 percent above the level during the last glacial maximum.<sup>11</sup> Likewise, the atmospheric concentration of methane is increasing more than 400 times faster than natural rates of variability.<sup>12</sup>

Climate models attempt to explain and predict how climate varies. The best current models predict global average surface temperatures will increase 0.5 to 2 °C by 2030. However, these models have large uncertainties. They also provide widely varying estimates of the geographic distribution and *consequences* of change.<sup>13</sup> No existing model is complete.<sup>14</sup> Taken together,

<sup>10</sup> Lorius, et al., op. cit.; J.M. Barnola, et al., “Vostok Ice Core Provides 160,000-Year Record of Atmospheric CO<sub>2</sub>,” *Nature* 329:408-414, 1987.

<sup>11</sup> IPCC, *Scientific Assessment of Climate Change*, op. cit., footnote 6.

<sup>12</sup> J. Chappellez et al., “Ice-Core Record of Atmospheric Methane Over the Past 160,000 Years,” *Nature* 345: 127-131, 1990.

<sup>13</sup> U.S. Environmental Protection Agency, *The Potential Effects of Global Climate Change on the United States*, December 1989.

<sup>14</sup> See Peter H. Stone, “Forecast Cloudy: The Limits of Global Warming Models,” *Technology Review*, February/March 1992, pp. 32-40; Bette Hileman, “Web of Interactions Makes it Difficult to Untangle Global Warming Data,” *Chemical and Engineering News*, Apr. 27, 1992, pp. 7-19.

## 100 I Remote Sensing From Space

existing models provide a range of predictions regarding future climate. After reviewing numerous models, the IPCC has concluded that if present emission trends continue, global average temperatures could rise by roughly an additional 1.0 °C by the year 2030.

If the climate were to change drastically, the effects would not be felt uniformly. Regional changes are extremely hard to predict because of constantly changing atmospheric and oceanic circulation patterns. Greater warming is likely to occur in some areas; negligible change or cooling is expected in others. Some regions may experience more drought, others more precipitation and perhaps changes in the frequency and intensity of storms.<sup>15</sup>

The significance of climate change predictions is not clear. Although the evidence that human activity is largely responsible for a changing climate is not beyond dispute,<sup>16</sup> data collected over the past century justify concern over climate. Reasons for concern include hypotheses that climate change could:

1. rapidly shift climate zones, preventing the adaptive migration of animals and plants;
2. speed the extinction of many species;
3. diminish water quality (a result of algal blooms in warmer water) in many freshwater lakes and rivers;
4. raise sea level, effectively reducing the amount of beaches and coastal wetlands;
5. reduce agricultural yields, possibly increase others, but change the distribution of crops;
6. increase the ranges of agricultural pests;
7. increase the demand for electricity;
8. diminish air quality (increased emissions from electric plants, speed atmospheric chemical reactions that produce atmospheric O<sub>3</sub>);
9. change morbidity patterns, decrease winter mortality, increase summer mortality;

10. change infrastructure needs of many cities;
11. diminish freshwater resources in many regions.<sup>17</sup>

Since mitigating human impact on the environment is expensive and risky, economic uncertainty is often used to justify the expense of developing new remote sensing systems. The benefits derived from increased knowledge of the effects of global change could far outweigh the average yearly costs for space-based global change research (about \$1 billion annually).

### CURRENT ENVIRONMENTAL AND CLIMATE RESEARCH EFFORTS

Increased data on climate change and heightened international concern convinced the U.S. government of the need to address global change. In 1989, the Director of the Office of Science and Technology Policy, D. Allan Bromley, established an inter-agency U.S. Global Change Research Program (USGCRP) under the Committee on Earth and Environmental Sciences (in OSTP).<sup>18</sup> Established as a Presidential initiative in the FY 1990 budget, the goal of the program is to develop sound national and international policies related to global environmental issues. The USGCRP has seven main science elements:

1. climate and hydrodynamic systems,
2. biogeochemical dynamics,
3. ecological systems and dynamics,
4. earth systems history,
5. human interaction,
6. solid earth processes, and
7. solar influences.

Participation in the USGCRP involves nine government agencies and other organizations. <sup>19</sup> This research effort, and the efforts initiated by independent organizations (above), seek a better understanding of global

---

<sup>15</sup> Much of the information in this section originally appeared in U. S. Congress, Office of Technology Assessment, *Changing by Degrees. Steps to Reduce Greenhouse Gases*, OTA-O-482 (Washington, DC: U.S. Government Printing Office, February 1991).

<sup>16</sup> See Richard S. Lindzen, "Global Warming, The Origin and Nature of the Alleged Scientific Consensus," *Regulation, The Cato Review of Business and Government*, Spring 1992. Lindzen states, "Not only are there major reasons to believe that models are exaggerating the response to increasing carbon dioxide, but, perhaps even more significantly, the models' predictions for the past century incorrectly describe the pattern or warming and greatly overestimate its magnitude."

<sup>17</sup> U.S. Environmental protection Agency, *The potential Effects of Global Climate Change on the United States*, EPA-230-05-89-050, December 1989.

<sup>18</sup> For further information see "Our Changing Planet: The FY 1992 Research Plan," The U.S. Global Change Research Program, A Report by the Committee on Earth and Environmental Sciences, a supplement to the U.S. President's Fiscal Year 1992 Budget.

<sup>19</sup> Including the Smithsonian Institution and the Tennessee Valley Authority.

change. All will rely on remote observations of atmosphere, oceans, and land for data.

## | Mission to Planet Earth

The concept of Mission to Planet Earth evolved over several years.<sup>20</sup> In 1982, at a U.N. space conference (Unispace '82), NASA proposed a comprehensive, U.S.-led program to monitor the health of the Earth. Called the Global Habitability Program, it was largely ignored by the conference participants.<sup>21</sup> In 1985, the Global Habitability concept was transformed, NASA sought to apply the concepts described by global habitability to research focused on long-term physical, chemical, and biological changes on a global scale.<sup>22</sup> The research effort will rely on data collected by ground, air, and space-based systems. NASA has coordinated its efforts with the Committee on Earth and Environmental Sciences, and agencies of the Federal Government.

NASA's stated goal for Mission to Planet Earth is to "establish the scientific basis for national and international policymaking relating to natural and human induced changes in the global Earth system."<sup>23</sup> The primary program objectives include establishing an integrated, comprehensive, and sustained program to document the Earth system on a global scale. Mission to Planet Earth scientists will conduct focused, exploratory studies to improve understanding of the physical, chemical, biological and social processes that influence Earth system changes and trends on global and regional scales. NASA-supported scientists will provide information for policymakers based on integrated conceptual and predictive Earth system models.

Mission to Planet Earth will address the following key uncertainties regarding climate change:

1. role of greenhouse gases,
2. role of clouds,
3. role of oceans,
4. role of polar ice sheets,
5. land surface hydrology, and
6. ecosystems response.

These parallel the priorities set by the Committee on Earth and Environmental Sciences. NASA has worked to align the instruments proposed for EOS with the scientific and policy goals addressed by the U.S. Global Change Research Program.

## EOS AND RELATED SYSTEMS

NASA considers the Earth Observing System the cornerstone of the Mission to Planet Earth. EOS is to be a multiphase program that NASA expects to last about two decades.<sup>24</sup> The core of EOS will be three copies of two satellites, capable of being launched by an Atlas II-AS booster, a medium lift launcher that is under development.

The EOS program begins with a number of 'phase one' satellites (most of which predate the EOS concept, and are funded through other programs) that would provide observations of specific phenomena. The Upper Atmosphere Research Satellite (UARS), which has already provided measurements of high levels of chlorine monoxide (ClO)<sup>25</sup> above North America, is an example of an EOS phase one instrument. NASA's EOS plans also include three smaller satellites (Chemistry, Altimeter and Aero), that would observe specific aspects of atmospheric chemis-

<sup>20</sup> For more background on the genesis of Mission to Planet Earth, see Burton Edelson, Science, Jan. 25, 1985, (Editorial); CRS Report to Congress, "Mission to Planet Earth and the U.S. Global Change Research program," Marcia S. Smith and John Justis, June 19, 1990; Sally K. Ride, "Leadership and America's future in Space," A Report to the NASA Administrator, August 1987. The "Ride Report," as this document has become known, strongly advocates Mission to Planet Earth as a top priority for NASA's future.

<sup>21</sup> See U.S. Congress, Office of Technology Assessment, *UNISPACE '82: A Context for International Cooperation and Competition, OTA-ISC-TM-26* (Washington DC: U.S. Government Printing Office, March 1983), for more information regarding U.S. proposals and the debate over militarization.

<sup>22</sup> Ibid.

<sup>23</sup> presentation of Shelby Tilford, Director, NASA Earth Science and Applications Division, to the Woods Hole Space Science and Applications Advisory Committee Planning Workshop, July 1991.

<sup>24</sup> See ch. 2, ch. 5, and app. B for more details about NASA'S Mission to Planet Earth and EOS.

<sup>25</sup> Chlorine monoxide is a chemical compound that, when affected by sunlight in the upper atmosphere, leads to degradation of O<sub>3</sub>. Ozone is formed in the stratosphere by the reaction of atomic oxygen (O) with molecular oxygen (O<sub>2</sub>). This process is begun by the dissociation of O<sub>2</sub> into O by absorption of solar ultraviolet radiation at wavelengths below 240 nm. This process occurs at altitudes above 25 km. This process can be interrupted by Cl: Cl+O<sub>3</sub>→ClO+O<sub>2</sub> . . . ClO+O→Cl+O<sub>2</sub>. ClO is therefore a precursor of disappearing ozone.

### BOX A-3-Measurements of Ozone Depletion

For most global change and climate change research, a combination of satellite and in situ measurements is required to obtain sufficient data. One of the best examples of the need for both types of measurements is the discovery of the ozone hole above Antarctica. Researchers from the United States and Great Britain had been measuring atmospheric conditions over Antarctica: the U.S. team relying on satellite sensors; the British team using ground-based spectrophotometers. In 1983-84, the British team recorded a series of measurements of ozone that seemed extraordinarily low (below 200 Dobson units).<sup>1</sup> Data from the Total Ozone Mapping Spectrometer (TOMS) aboard Nimbus-7 and the Solar Backscatter Ultraviolet Radiometer (SBUV) aboard polar-orbiting NOAA satellites were automatically processed by computer before being analyzed. U.S. scientists felt that any readings below 200 Dobson units would be outside the range of possibility and were likely the result of a sensor anomaly; hence they designed a computer algorithm that ignored such measurements. Data were stored, and subsequently reviewed, but these readings were originally dismissed.

Neither did the British team believe its own readings. The first conclusion that project director Joe Farman and his team reached was that their ground-based sensors, which were old, had been improperly calibrated. Yet when anew, updated sensor produced similar results, they realized that the loss of ozone was much greater than anyone expected. This experience demonstrates one of the advantages of ground-based sensors: sensor packages can be easily replaced to validate the performance of the original system. It also demonstrates the dangers of establishing a threshold for expected results.

Researchers have learned several lessons from the discovery of cyclical ozone depletion over Antarctica. First, because ground-based sensors observe specific phenomena from a site whose environmental parameters can be thoroughly characterized, they are sometimes more adept at detecting regional change or unusual local environmental conditions than are satellite-based sensors. Second, although it is sometimes difficult to distinguish between real results (signal) and invalid measurements (noise), setting predetermined limits on natural phenomena while studying global change is not judicious. Third, even accepted models, such as the one that provided the parameters for the U.S. research team, can be far wrong. All models should be scrutinized and tested periodically.

<sup>1</sup>The Dobson unit is a measurement of thickness standardized to the thickness of the ozone layer at 32 degrees Fahrenheit and sea level atmospheric pressure. One Dobson unit is equivalent to .001 cm of ozone.

SOURCE: Office of Technology Assessment, 1993.

try, ocean topography, and tropospheric winds. In addition, NASA plans to include data from "Earth Probes," additional copies of sensors that monitor ozone and ocean productivity, in the EOS Data and Information System. See box A-3 for a description of ozone measurement.

The EOS Data and Information System (EOSDIS) will be a key feature of EOS (box A-4). According to NASA, data from the EOS satellites will be available to a wide network of users at minimal cost through the EOSDIS. NASA will develop EOSDIS so it can store data and distribute them to many users simultaneously.

EOSDIS will require significant technology development, especially in software, storage, and data processing. EOSDIS will require a continued funding effort that will reach \$254 million in 1996. In total, EOSDIS is expected to cost \$946 million between 1991 and 1997. A future OTA report will examine the data issues related to remote sensing.

NASA plans to operate various EOS sensors for 15 years, providing researchers with data covering a complete solar cycle<sup>26</sup> and several El Ninos,<sup>27</sup> two large natural variables affecting Earth's climate. EOS sensors will be grouped or co-located by function to

<sup>26</sup> Approximately every 11 to 15 years, the Sun completes one solar cycle.

<sup>27</sup> A slight warming of the upper waters of the southern Pacific, occurring about every 4 to 7 years.

### Box A-4-The EOS Data and Information System

A central element of NASA's Mission to Planet Earth is the EOS Data and Information System. This system is intended to process, store, and distribute the data obtained from Mission to Planet Earth flight projects and scientific investigations. EOSDIS is intended to be sufficiently flexible to incorporate previously archived data, measurements from non-EOS spacecraft, and ground-, ocean-, and space-based measurements conducted by other Federal, foreign, and international agencies. Through the EOSDIS program, NASA has promised to provide a comprehensive system that will merge data from a wide variety of sources to serve integrated, interdisciplinary research. **EOSDIS is ambitious and complex; it must manage vast streams of data perhaps as many as 400 trillion bytes per year.** This is roughly equivalent to the amount of data that would fill 4 million 100-megabyte hard drives (approximately the amount of storage purchased with a new personal computer). NASA has made comparisons between the amount of data EOSDIS will handle and the amount of information stored in the Library of Congress. These comparisons are faulty, since the Library of Congress contains paintings, movies, pictures, in addition to printed media. It is more rational to think of the amount of data to be handled in EOSDIS in terms of the largest data bases currently on line, and no system in use to date has come close to handling this amount of data.

EOSDIS must also make these data easily usable for a very wide variety of users, possibly numbering as many as 100,000 people, many of whom will have little detailed technical knowledge of remote sensing. EOSDIS is intended to provide the tools needed to transform data into information, through activities such as the development and integration of algorithms ("formulas") for data analysis, the communication and exchange of data among scientists, the maintenance of standards and formats for data and information, and the archiving of scientific information for access by others.

Structurally, EOSDIS will consist of at least seven research science-oriented Distributed Active Archive Centers (DAACS), and several Affiliated Data Centers. The seven sites selected as EOS DAACS are currently functioning as relatively independent data centers. When linked together and integrated into EOSDIS, the DAACS will receive raw data from EOS spacecraft and other sources, process the data, and provide data and information to users. Three systems will operate at each DAAC:

1. a product generation system (PGS),
2. a data archive and distribution system (DADS), and
3. an information management system (IMS).

The product generation system at each DAAC will convert raw data signals into standard sets of Earth science data, using data processing software developed by the scientific user community. The data archive and distribution system at each DAAC will serve as the archive and distribution mechanism for EOS data products, as well as other data sources both within and outside the EOS program. The information management system at each DAAC will give users access to all data throughout EOSDIS, as well as help in locating and ordering data. When fully operational, a scientist signing onto EOSDIS at any DAAC site will have complete access to all data sets anywhere in EOSDIS, regardless of physical location. NASA has promised to have processed data available to scientists through EOSDIS within 4 days of initial observations.

NASA has adopted an "evolutionary" approach for the development of EOSDIS, since pre-definition of all EOSDIS requirements is impossible (e.g., the science and data requirements for studies of the Earth system will change as our knowledge and experience grow, and most EOSDIS users are currently not practicing Earth system scientists; some are not yet born). EOSDIS is to have an "open" architecture, meaning that new hardware and software technologies will be easily inserted as EOSDIS evolves, and changing user requirements can be accommodated. Feedback from users is intended to inform each new increment of EOSDIS, a "learn-as-you-go" approach.

*(continued on next page)*



### Box A-4-The EOS Data and Information System-Continued

NASA is currently developing an early EOSDIS system ("Version O") to improve access to existing data and to test the interoperability of existing systems. Version O includes the development of user-friendly "pathfinder" data sets from archived data of NOAA, DOD, and Landsat satellites, developing commonality among DAAC data systems, and prototyping a few EOSDIS technologies. Version O is scheduled to be in place by late 1994. Versions 1 through 6 are planned to be delivered through a single contractor, Hughes Information Technology. Version 1 will provide PGS, DADS, and IMS functions at each DAAC, and examine prototyping technologies for data processing and scheduling functions for EOS instruments. NASA plans to have Version 1 operational at all DAACS by 1996. Version 2 will be the first full-scale operational EOSDIS, using data from the first EOS platform, and is scheduled to be operating by the mid-1998 launch of the EOS AM1 spacecraft. Versions 3 through 6 will follow as subsequent spacecraft are launched and science needs evolve.

**SOURCE:** National Aeronautics and Space Administration, General Accounting Office, National Research Council, House of Representatives Science, Space and Technology Committee

provide simultaneous coverage by complementary instruments. Another advantage to the broad array of sensors carried by the EOS platforms will be the ability to isolate the effects of individual variables. A goal of EOS is to make possible real-time analysis of these observations.

NASA has scheduled the launch of the first EOS satellite for 1998. Critics of EOS claim that this schedule does not allow for timely data gathering. The possibility exists that gaps in monitoring stratospheric ozone could occur in 1995-2000, especially if the Upper Atmosphere Research Satellite (UARS, the first of the EOS Phase One satellites) that concentrates on measuring upper atmosphere ozone, fails to live past its expected lifetime (1995). Germany had been planning a satellite to monitor ozone, but tight budgets may prevent such an effort. TOMS (total ozone mapping spectrometers) will be available on other satellites, but may not have the ability to "record in detail the chemical changes occurring in the stratosphere."<sup>28</sup> Scientists express concern that similar gaps will exist in other climate monitoring efforts, and will likely arise during the lifetime of EOS. The reality of austere budgets will affect global change research: smaller than expected budgets will not allow funding

for all observation/monitoring projects, despite needs for scientific information.

### EOS INSTRUMENTS

**EOS Phase One**—EOS Phase One is a series of small satellites that have been grouped together under the aegis of EOS. Most of these satellites were funded under existing programs prior to inclusion in the EOS program. Phase one includes the instruments below,<sup>29</sup> which will be launched beginning in 1993.

- Sea Wide Field Sensor (SeaWiFS), an ocean color sensor to study ocean productivity and ocean/atmosphere interaction, still an area of climate uncertainty.
- Total Ozone Mapping Spectrometer, additional copies of the TOMS instruments to fly on NASA explorer class satellites and on Japan's Advanced Earth Observation Satellite (ADEOS). An earlier version of TOMS had flown on Nimbus-7 in 1978, and on a (then) Soviet Meteor-3 on August 15, 1991. Japan has developed the ADEOS as an international effort (app. D); the U.S. is providing two of the sensors,<sup>30</sup> France is providing one,<sup>31</sup> and Japan will develop several others, including an interferometric monitor for greenhouse gases and

<sup>28</sup> "Gaps Loom in Satellite Data," *Nature*, vol. 335, p. 662, Feb. 20, 1992.

<sup>29</sup> The number of Phase One experiments that will survive the most recent budget cut was unknown at the time this report went to press. NASA will also include data from POES, GOES, DMSP, Landsat and other satellites in the EOSDIS, hence NASA also lists data from these satellites as phase one data.

<sup>30</sup> The sensors are the total ozone mapping spectrometer (TOMS) and NASA Scatterometer.

<sup>31</sup> Polarization and Directionality of the Earth's Reflectance (POLDER).

an improved limb atmospheric spectrometer. ADEOS will be used to measure ozone and other gases, as well as measure ocean surface winds.

- The NASA Scatterometer, an instrument designed to study the ocean's surface to determine wind patterns and air-sea interaction, now tentatively scheduled for flight on ADEOS-11.
- The Tropical Rainfall Measurement Mission (TRMM), also a joint program with Japan, will make extensive measurements of precipitation, clouds and hydrology in tropical regions, which cannot be time-sampled adequately from polar orbit.<sup>32</sup>
- TOPEX/Poseidon, a group of sensors for measuring ocean topography and altimetry on a platform launched by France on an Ariane booster in August 1992.

The Upper Atmosphere Research Satellite, launched in September 1991, became the first of these Phase One satellites to enter service. Although its development began in 1985, UARS is viewed as the first major project of the Mission to Planet Earth. The UARS platform carries 10 instruments in order to meet two project goals:

1. Observe the atmosphere over the northern hemisphere during two winters. The northern hemisphere has a greater terrain/ocean ratio, thus providing a highly dynamic interaction between earth, ocean and atmosphere. Although UARS may function for over nine years, the instrument for these observations (the Cryogenic Limb Array Etalon Spectrometer or CLAES) requires cryogenics that will be exhausted in about 2 years.
2. Observe dynamic processes (presence of chlorofluorocarbons, stratospheric winds, etc.) responsible for the hole in the ozone layer above Antarctica.<sup>33</sup>

Other instruments carried on the UARS include an improved Stratospheric and Mesospheric Sounder used to observe infrared molecular emissions, a microwave limb sounder used to measure chemicals

(especially chlorine monoxide) in the upper atmosphere, a halogen occultation experiment, a wind imaging interferometer, a solar ultraviolet spectral irradiance monitor, a solar stellar irradiance instrument, and a particle environment monitor.<sup>34</sup>

#### EOS-AM

**The EOS-AM satellites,<sup>35</sup> the first of which NASA plans to launch in June 1998, will characterize the terrestrial surface and examine the aerosol and radiation balance within clouds. It will carry five sensors.**

1. The Clouds and Earth's Radiant Energy System (CERES) will provide earth scientists with measurements of cloud and radiation flux. The measurements will be taken with two broadband scanning radiometers, each functioning on three channels. These radiometers will calculate the amount of radiation that is reflected by the Earth's surface and the amount reflected by clouds. Comparing these measurements will allow a better understanding of the role that clouds play in regulating the earth's climate. Measurements of reflected radiation and the reflective efficiency of different cloud types will enable development of global oceanic and atmospheric models.
2. The Moderate Resolution Imaging Spectroradiometer—(MODIS), will be used to measure biological and physical processes that do not require along-track pointing. These applications will include long-term observation of **surface** processes/global dynamics such as: surface temperature; ocean color; chlorophyll fluorescence; concentration of chlorophyll; vegetation cover, productivity; fires; snow cover/reflectance; cloud cover; cloud properties. Data collected by MODIS will be used to take global measurements of chlorophyll, dissolved organic matter and other constituents that provide insight about ocean productivity. MODIS will provide data useful to the determination of the role of the oceans in the

<sup>32</sup>Shelby G. Tilford, Gregory S. Wilson and Peter W. Backlund, "Mission To Planet Earth," paper presented at the 42d Cong. of the International Astronautical Federation Oct. 5-11, 1991, Montreal, Canada.

<sup>33</sup>"Discovery I: Launch First Element of NASA's Mission to Planet Earth," *AviationWeek and Space Technology*, Sept. 9, 1991, pp. 63-67.

<sup>34</sup>Ibid.

<sup>35</sup>For a more complete description of EOS instruments, see NASA's 1993 EOS Reference Handbook, NASA, Earth Science Support Office.

global carbon cycle. These data will have applications in models as well as providing information regarding the productivity of aquatic and terrestrial plants. Measurements of total precipitation and aerosol properties will also be facilitated by MODIS measurements.

3. The Multiangle Imaging Spectra-Radiometer (MISR) will be the only EOS instrument that will provide information on cloud and surface angular reflectance. The instrument is designed to obtain images of each scene from multiple angles and in four spectral bands. The data are collected using nine charged-coupled device (CCD) pushbroom cameras. Measurements taken by MISR will allow researchers to determine the effects of aerosols in the atmosphere, understand how different cloud types affect the radiation budget, evaluate some changes in the Earth's forest and deserts, and study aspects of interaction between biophysical and atmospheric processes.
4. The Advanced Spaceborne Thermal Emission and Reflection radiometer (ASTER) is an imaging radiometer that will be used to provide high spatial resolution images of land, water, and clouds. ASTER is one of Japan's contributions to the EOS program. Images taken in the visible and near infrared, shortwave infrared, and thermal infrared wavelengths will be used in the study of soil and rock formations, to monitor volcanoes, and to measure surface temperatures, emissivity and reflectivity. The visible and near infrared and shortwave infrared channels will also have the ability to provide information on land use patterns and vegetation. The very near infrared and thermal infrared capabilities will provide information on coral reefs and glaciers. Some evaporation and land and ocean temperature readings will be possible as well.
5. Measurements of Pollution In The Troposphere, or MOPITT, a correlation spectrometer, will provide measurements of pollution in the troposphere at three wavelengths in the near infrared. It will specifically measure levels of carbon monoxide and methane.

NASA plans to include the Earth Observing Scanning Polarimeter (EOSP) on the second AM platform (an earlier flight of EOSP was rejected by NASA—see

app. B). EOSP will be designed to map the radiance and linear polarization of reflected and scattered sunlight through 12 spectral bands, and provide global measurements of aerosol distribution and cloud properties. EOSP is a polarimeter that scans cross-track, providing a global profile of aerosol optical thickness. These data will correct clear-sky ocean and land measurements that are of critical importance to other optical measurements of the Earth's surface.

In addition to EOSP, AM-1 will carry a second instrument not on the first AM platform. The Tropospheric Emission Spectrometer (TES) will be an infrared imaging spectrometer that will provide global three-dimensional profiles of all infrared-active species from surface to lower stratosphere. This information will be used to study greenhouse gases, tropospheric ozone, precursors of acid rain, and gas exchange in the stratosphere leading to ozone depletion.

#### EOS COLOR

**EOS-Color (1998) will measure oceanic biomass and productivity.**

- . The Sea Wide Field of view Sensor (SeaWiFS-11) will be a multi-band (8) imager that will operate in the very near infrared portion of the spectrum. SeaWiFS will be used to observe chlorophyll, dissolved organic matter and pigment concentrations in the ocean. The sensor will contribute to understanding the health of the ocean and concentration of life forms in the ocean.

#### EOS AERO

**EOS-Aero (2000) will measure atmospheric aerosols.**

- . The Stratospheric Aerosol and Gas Experiment (SAGE III) will be a grating spectrometer, designed to obtain global profiles of aerosols, ozone, water vapor, nitrous oxides, airborne chlorine, clouds temperature and mesospheric, stratospheric and tropospheric pressure. SAGE is a follow-on to earlier instruments of the same name. SAGE III will be self-calibrating, and will have a better vertical range than its predecessors.

#### EOS-PM

**EOS-PM (2000) will examine clouds, precipitation and the Earth's radiative balance; will meas-**

**ure terrestrial snow and sea ice; observe sea surface temperature and monitor ocean productivity.**

- CERES (see above).
- MODIS-N (see above).
- The Atmospheric Infrared sounder (AIRS) is a high spectral resolution sounder that will provide temperature and humidity profiles through clouds. It will measure outgoing radiation and be able to determine land skin surface temperature. In addition, the sounder will be capable of determining cloud top height and effective cloud amount, as well as perform some ozone monitoring.
- The Advanced Microwave Sounding Unit (AMSU-A) and the Microwave Humidity Sounder (MHS) are both microwave radiometers that will provide all weather atmospheric temperature measurements from the surface up to 40 km (AMSU) and atmospheric water vapor profiles (MHS).
- The Multifrequency Imaging Microwave Radiometer (MIMR) will provide passive measurements of precipitation, soil moisture, global snow and ice cover, sea surface temperature, cloud water, water vapor and wind speed, MIMR will be provided to NASA by the European Space Agency.

#### **EOS-ALT**

**EOS-Alt (2002) will observe ocean circulation and ice sheet mass balance using the following instruments:**

- The EOS altimeter (ALT) will be a dual frequency radar altimeter. ALT will provide mapping data for sea surface and polar ice sheets. The return pulse of the radar can also provide information on ocean wave height and wind speed.
- The Geoscience Laser ranging system and altimeter (GLRS-A) will be tailored to measure geodynamic, ice sheet, cloud, and geological processes and features.

#### **EOS-Chem**

**EOS-Chem (2002) will track atmospheric chemical species and their transformations; and measure ocean surface stress.**

- The High Resolution Dynamics Limb Sounder (HIRDLS) will be an infrared scanning radiometer that derives from similar units deployed on the Nimbus and UARS satellites. It will be used to sound the upper troposphere, stratosphere and mesosphere to determine temperature; concentrations of O<sub>3</sub>, greenhouse gases, and aerosols; locations of polar stratospheric clouds/cloud tops.
- The Active Cavity Radiometer Irradiance Monitor (ACRIM) is designed to measure solar output and variations in the amount of radiation that enters the atmosphere.
- The Stratospheric Aerosol and Gas Experiment (SAGE III) will be the third in a series of similar instruments. See description under AERO, above.
- Microwave Limb Sounder (MLS) is a passive, limb sounding radiometer. The MLS will be designed to study and monitor atmospheric processes that affect ozone. Particular emphasis will be given to the impact of chlorine and nitrogen.
- NASA may try to fly the GPS Geoscience Instrument (GGI) aboard the Chem satellite. GGI will be designed to contribute to the accuracy of mapping data collected by other sensors (down to the centimeter level). It will also play a role in ionospheric gravity wave detection.

The primary EOS spacecraft, AM and PM, will be replaced over time to ensure at least 15 years of coverage. Follow-on payloads will remain flexible to meet needs as determined by the evolution of scientific understanding derived from earlier launches.<sup>36</sup>

---

<sup>36</sup> Statement by L.A. Fisk, Associate Administrator for Space Science and Applications, National Aeronautics and Space Administration, before the Subcommittee on Science, Technology and Space, Committee on Commerce, Science and Transportation, United States Senate (102d Cong.), Feb. 26; 1992.

# Appendix B: The Future of Earth Remote Sensing Technologies

**T**his appendix examines technology issues associated with the research, development, and acquisition of future U.S. civilian Earth observation systems. It begins with a review of EOS science priorities and the effect of EOS program restructuring on the development of advanced remote sensing technology. This appendix also discusses ongoing efforts to develop affordable and/or less risky versions of several large EOS “facility” instruments that were deferred or deleted during program restructuring. Next, the appendix briefly summarizes sensor platform and design considerations, including design compromises and tradeoffs that must be made to match a particular mission with an appropriate sensor and platform combination.

Finally, this appendix explores the state of the technical ‘‘infrastructure’’ for future space-based remote sensing efforts. Researchers interviewed by OTA generally believed that planned efforts in technology development at the component level were sufficient to develop next-generation sensors. However, they were less sanguine in their assessment of efforts for ‘‘engineering’’ development, for example, the packaging and prototyping of integrated, space-qualified sensors. Engineering development, while not as glamorous as basic science, is essential if the United States wishes to reduce the size, weight, and cost of space-based sensors and platforms. As discussed below, engineering issues also enter into debates over the maturity of proposals to develop new small satellites.

Introducing advanced technologies in Earth remote sensing systems raises several issues, including the role of government in identifying and promoting R&D for Earth remote sensing; and the timing of the introduction of new technologies in operational remote sensing programs. NOAA’s problems with the development of its GOES-Next environmental satellite system brought the latter issue to congressional attention (see ch. 3). The issue has also arisen in connection with the selection of sensors for Landsat 7, now scheduled for launch in 1997.

Finding a balance between the risks and potential benefits of technical innovation is a particular problem in satellite-based remote sensing systems because these systems are characterized by long lead times and high costs. Payload costs are a sensitive function of satellite weight and volume.<sup>1</sup> In principle, satellite weight and volume might be reduced by incorporating advanced technologies, now in development, with next generation spacecraft. However, in practice, proposed new instrument technologies are often at an early stage of development and have not demonstrated the ability to provide the stable, calibrated data sets required for global change research. In addition, they may not have the fully developed data processing systems and well-understood data reduction algorithms required to transform raw data into useful information.<sup>2</sup> The requirements for stability, calibration, and well-developed data analysis systems are particularly evident in long-term monitoring missions.

Historically, programs have attempted to minimize risk in satellite programs by introducing new technologies in an evolutionary manner, typically only after subjecting them to exhaustive tests and proving designs in laboratory and aircraft experiments.<sup>3</sup> Although experts generally agree on the desirability of accelerating this relatively slow process, they do not agree on the risk that would be associated with a change in the traditional development cycle.<sup>4</sup> **The risks in developing a new sensor system have two components: the technical maturity of component technologies (e.g., the detector system), and the**

**design maturity. A particular design that has not been used before may be a relatively risky venture for an operational program, even if it is based on proven technology.**<sup>5</sup>

Efforts to develop and flight-test emerging technologies have been limited by a number of factors, including budget constraints; scientific disputes over the merits of specific proposals; intra-agency and inter-agency rivalries; and the absence of a coherent strategy for remote sensing, developed within the executive branch and supported by the relevant authorization and appropriation committees of Congress. **These problems are embedded in an issue of even greater concern to global change researchers—whether it will be possible to sustain institutional commitments, including those from NASA, DOE, and DoD, for periods of time that are long compared to the time for changes in the executive branch and in Congress.** Without such a commitment, much of the current effort to develop strategies and instrumentation to monitor important climatological variables could be wasted.

## | Technology and the Restructured Earth Observation System

In conjunction with its international partners, the United States plans a program of Earth observation systems to provide, by the early years of the next century, comprehensive monitoring of Earth resources, weather, and natural and human-induced physical and

<sup>1</sup> U.S. Congress, Office of Technology Assessment, *Affordable Spacecraft: Design and Launch Alternatives*, OTA-TM-ISC-60 (Washington, DC: U.S. Government Printing Office, September 1990).

<sup>2</sup> The complex analysis required to measure the Earth's radiation budget (**discussed** below) provides an illustrative example.

<sup>3</sup> For example, in the 1960s and 1970s NASA and NOAA had a successful 3-stage process for instrument development: (1) *technology development* was supported via an Advanced Applications Flight Experiments (**AAFE**) program for new instrument concepts, usually leading to tests on aircraft flights, (2) *research space flights* were provided for promising instruments graduating from **AAFE**, on the Nimbus satellite series, with flights every 2 or 3 years, (3) *operational satellites* carried instruments selected from those tested via the **first** two stages.

<sup>4</sup> A phased development cycle has traditionally been used to procure operational systems. The steps in this cycle can be grouped as follows:

Phase A—Study Alternate Concepts

Phase B—Perform Detailed Design Definition Study (manufacturing concerns addressed in this stage)

Phase C—Select Best Approach/Build and Test Engineering Model

Phase D—Build Flight Prototype and Evaluate on Orbit

This approach should be contrasted with a “skunk-works” approach, which omits some of these steps. Historically, the skunk-works approach has usually been thought more risky than the methodical approach. As a result, it has been used mostly for demonstrations and experiments.

<sup>5</sup> Recognizing this problem, the Advanced Research Projects Agency (ARPA) has proposed several advanced technology demonstrations (ATDs) on small satellites that, if successful, would rapidly insert technology and shorten acquisition time for larger satellites. These demonstrations would couple innovative sensor design with a scalable high-performance common satellite bus that would employ a novel “bolt-on” payload-bus interface.

chemical changes on land, in the atmosphere, and in the oceans (see chs. 3-5). NASA's Earth Observing System of satellites is the centerpiece of NASA's Mission to Planet Earth. NASA has designed EOS to provide 15 years of continuous high-quality data sets related to research priorities recommended by the Intergovernmental Panel on Climate Change (IPCC) and the Committee on Earth and Environmental Science (CEES) of the Federal Coordinating Council for Science, Education, and Technology (FCCSET) (table 5-1 ). To achieve 15-year data sets, each of two EOS polar platforms, with a design life of 5 years, would be flown three times. Most scientists believe an observation period of 15 years is long enough to observe the effects of climate change resulting from the sunspot cycle (11 years), several El Nino events, and eruptions of several major volcanoes. It should also be possible to observe some effects of deforestation and other large-scale environmental changes. Scientists are less certain whether 15 years is long enough to distinguish the effects of anthropogenic greenhouse gases on Earth's temperature from natural background fluctuations. Ecological studies of the health and migration of terrestrial systems also require longer continuous records (on the order of 20-50 years).

Intermediate-size, polar-orbiting satellites are the principal EOS platforms for sensors gathering global change data.<sup>6</sup> Measurements for MTPE can be broadly divided into two types:

1. Long-term monitoring—to determine if climate is changing, to distinguish human-induced from naturally induced climate change, and to determine global radiative forcings and feedbacks (box B-1).

2. Mechanistic or “process” studies—detailed analysis of the processes that govern phenomena ranging from the formation of the Antarctic ozone hole to the gradual migration of tree species.<sup>7</sup>

Global change researchers disagree over whether the EOS program as currently configured is optimally designed to perform these different missions and whether the EOS program will address the most pressing scientific and policy-relevant questions. EOS program officials point to repeated and extensive reviews by interdisciplinary panels in the selection of instruments and instrument platforms as evidence that their program is properly structured. Program officials also note that payload selection panels followed priorities set by members comprised mostly of theorists who would be the users of data, rather than instrument builders hoping for approval of a particular mission. Nevertheless, some Earth scientists express concern that:

- The limitations of satellite-based platforms will prevent process-oriented studies from being performed at the level of detail that is required to address the most pressing scientific questions;
- Continuous long-term (decadal time-scale) monitoring is at risk, because of the high-cost, long lead times, and intermittent operations that have historically characterized design, launch, and operation of large multi-instrument satellite platforms.

According to this view, a more “balanced” EOS program might have greater support for small satellites and a more balanced USGCRP program might include greater support for groundbased measurement pro-

<sup>6</sup> These are multi-instrument satellites and are relatively expensive. For example, NASA estimates that total hardware development costs for the EOS AM-1 satellite and its sensors will approach \$800 million. This figure does not include launch costs, which are expected to be \$100-150 million, or ground segment and operations costs. EOS AM-1 includes the U.S.-developed MODIS, MISR, and CERES instruments and the foreign-supplied ASTER and MOPITT instruments (provided at no cost to build to the United States).

The cost of building follow-ons in the AM series would be substantial, less as much of the initial cost is associated with nonrecurring instrument and spacecraft bus design and development costs and one-time acquisition of ground support elements. Savings of 50 to 70 percent may be possible, depending on the acquisition time-schedule. EOS' PM series of multi-instrument satellites will not be a copy of the AM series. Costs for PM-1 are expected to be similar, but somewhat lower, than for AM-1. Follow-ons to the PM series may not be as expensive as follow-ons in the AM-1 series because most of the PM instruments are repeated.

<sup>7</sup> Scientists make no clear delineation between process studies and monitoring studies. In general, global change researchers use the term “process study” to refer to short-term, less costly, and more focused experiments that aim to elucidate the details of a particular mechanism of some geophysical, chemical, or biological interaction. The distinction is least useful for studies of the land surface, which may require years or more of study (for example, studies of terrestrial ecosystems may require a decade or more of observation to study a particular process such as migration of tree species).

### Box B-1-Climate Forcings and Feedbacks

Climate forcings are changes imposed on the planetary energy balance that alter the global temperature; radiative feedbacks are changes induced by climate change. Forcings can arise from natural or anthropogenic causes. Examples of natural events are the eruption of Mt. Pinatubo in June 1991, which deposited sulfate aerosols into the upper atmosphere, and changes in solar irradiance, which scientists believe may vary by several tenths of a watt/m<sup>2</sup> per century (the Earth absorbs approximately 240 watts/m<sup>2</sup> of solar energy). Examples of anthropogenic forcings appear in the table "Human Influence On Climate," below. At present, the dominant climate forcing appears to be the increasing concentration of greenhouse gases in the atmosphere.

The distinction between forcings and feedbacks is sometimes arbitrary; however, forcings can be understood as quantities normally specified in global climate model simulations, for example, CO<sub>2</sub> amount, while feedbacks are calculated quantities. Examples of radiative forcings are greenhouse gases (CO<sub>2</sub>, CH<sub>4</sub>, CFCS, N<sub>2</sub>O, stratospheric H<sub>2</sub>O), aerosols in the troposphere and stratosphere, solar irradiance, and surface reflectivity. Radiative feedbacks include clouds, water vapor in the troposphere, sea-ice cover, and snow cover. For example, an increase in the amount of water vapor increases the atmosphere's absorption of long-wave infrared radiation, thereby contributing to a warming of the atmosphere. Warming, in turn, may result in increased evaporation leading to further increases in water vapor concentrations.

The effects of some forcings and feedbacks on climate are both complex and uncertain. For example, clouds trap outgoing, cooling, longwave infrared radiation and thus provide a warming influence.<sup>1</sup> However, they also reflect incoming solar radiation and thus provide a cooling influence. Current measurements indicate that the net effect of clouds is a cooling one. However, it is uncertain if the balance will shift in the future as the atmosphere is altered by the accumulation of greenhouse gases.

An example of a radiative forcing whose effect on climate is uncertain is ozone. The vertical distribution of ozone (O<sub>3</sub>) affects both the amount of radiation reaching the Earth's surface and the amount of re-radiated infrared radiation that is trapped by the greenhouse effect. These two mechanisms affect the Earth's temperature in opposite directions. Predicting the climate forcing due to ozone change is difficult because the relative importance of these two competing mechanisms is also dependent on the altitude of the ozone change. Calculations by Dr. James Hansen of the Goddard Institute for Space Studies indicate that ozone loss in the upper stratosphere warms the Earth's surface because of increased ultraviolet heating of the troposphere; ozone addition in the troposphere warms the surface moderately; and ozone loss in the tropopause causes a strong cooling because the low temperature at the tropopause maximizes the ozone's greenhouse effect.<sup>2</sup>

<sup>1</sup>V. Ramanathan, Bruce R. Barkstrom, and Edwin Harrison, "Climate and the Earth's Radiation Budget," *Physics Today*, vol. 42, No. 5, May 1989, pp. 22-32.

<sup>2</sup>The troposphere, or lower atmosphere, is the region of the atmosphere where air is most dense and where most weather occurs. By this definition, the troposphere extends from the surface to altitudes of roughly 30,000-50,000 feet. In clear sky, the troposphere is largely transparent to incoming solar radiation, which is absorbed at the Earth's surface.

The temperature of the atmosphere falls steadily with increasing altitude throughout the troposphere (normally several °F per 1,000 feet altitude). The heat transfer by turbulent mixing and convection that results from this variation, the coupling of the Earth's rotation to the atmosphere, and latitudinal variations in temperature are responsible for the development and movement of weather systems. Troposphere temperatures reach a minimum at the tropopause, the boundary between the troposphere and the stratosphere, and then remain approximately constant through the lower stratosphere. The temperature rises again in the upper stratosphere. The tropopause can reach temperatures as low as 185 K (-126 °F) in the polar winter.



## Human Influence On Climate

*Fossil Fuel Combustion*

- CO<sub>2</sub> and N<sub>2</sub>O emission (infrared (IR) trapping)
- . CH<sub>4</sub> emission by natural gas leakage (IR trapping)
- . NO, NO<sub>2</sub> emission alters O<sub>3</sub> (ultraviolet absorption and IR trapping)
- . Carbonaceous soot emission (efficient solar absorption)
- . SO<sub>2</sub>-Sulfate emission (solar reflection)

*Land Use Changes*

- **Deforestation (releases CO<sub>2</sub>, increases albedo, and increases snow albedo feedback)**
- . **Regrowth (absorbs CO<sub>2</sub>, decreases albedo, and decreases snow albedo feedback)**
- . **Biomass burning (releases CO<sub>2</sub>, NO, NO<sub>2</sub>, and aerosols)**
- Landfills (releases CH<sub>4</sub>)

*Agricultural Activity*

- Releases CH<sub>4</sub> (IR trapping)
- **Releases N<sub>2</sub>O (IR trapping)**

*Industrial Activity*

- Releases CFCS (IR trapping and leads to ozone destruction)
- . Releases SF<sub>6</sub>, CF<sub>4</sub>, and other ultra-longlived gases (IR trapping virtually forever)

SOURCES: J. Hansen, W. Rossow, and I. Fung, "Long-Term Monitoring of Global Climate Forcings and Feedbacks," Proceedings of a Workshop held at NASA Goddard Institute for Space Studies, Feb. 3-4, 1992; and Johan Benson, "Face to Face," Interview with James Hansen, *Aerospace America*, April 1993, pp. 6-11. Table on human influence on climate adapted from Dr. Jerry D. Mahlman, "Understanding Climate Change," Draft Theme Paper, prepared for Climate Research Needs Workshop, Mohonk Mountain House, Nov. 8, 1991.

grams, including ocean measurement systems, and alternative sensor platforms, such as long-duration, high-altitude unpowered air vehicles.

The USGCRP and National Space Policy Directive 7 have assigned the lead role in enabling global observations from space to NASA (see ch. 2). Greater support for the non-space-based elements of the USGCRP would provide important data that would complement or correlate data derived from space-based platforms. Officials from the USGCRP, NASA, and NOAA who attended a February 1993 OTA workshop were unanimous in their belief that relatively modest additions of funds could produce substantial increases in scientific output.<sup>8</sup>

In restricting the EOS program (see ch. 5) NASA has sought to emphasize those global change issues

thought to be most in need of improved scientific understanding to support national and international policymaking activities. This has affected both mission priorities and instrument selection. **The restructured program's first priority is acquiring data on global climate change.** As a result, NASA has deferred missions designed to improve scientific understanding of the middle and upper atmosphere and of solid Earth geophysics. Instruments affected by this decision include new sensors for very high-resolution infrared, far-infrared, and submillimeter wave spectroscopy.

Deferral of instruments to monitor solid Earth physics, which includes the study of crustal and ice sheet movements, was based on the relative unimportance of these processes to global climate change. A

<sup>8</sup>For example, several officials agreed that increases in USGCRP budgets on the order of \$100 million per year for correlative measurements would 'double scientific output. Greater support for complementary non-space-based elements of the USGCRP could be provided either by redirection of already tight NASA budgets, from greater support for the USGCRP within the DOE, DoD, and other relevant departments and agencies, or from increases in USGCRP budgets. EOS program officials are emphatic in stating that their already reduced budget has little flexibility to accommodate further reprogramming. A discussion of this and related issues will appear in a forthcoming OTA background paper, "EOS and USGCRP: Are We Asking and Answering The Right Questions?"

Figure B-I—Physical Processes Operating In the Stratosphere

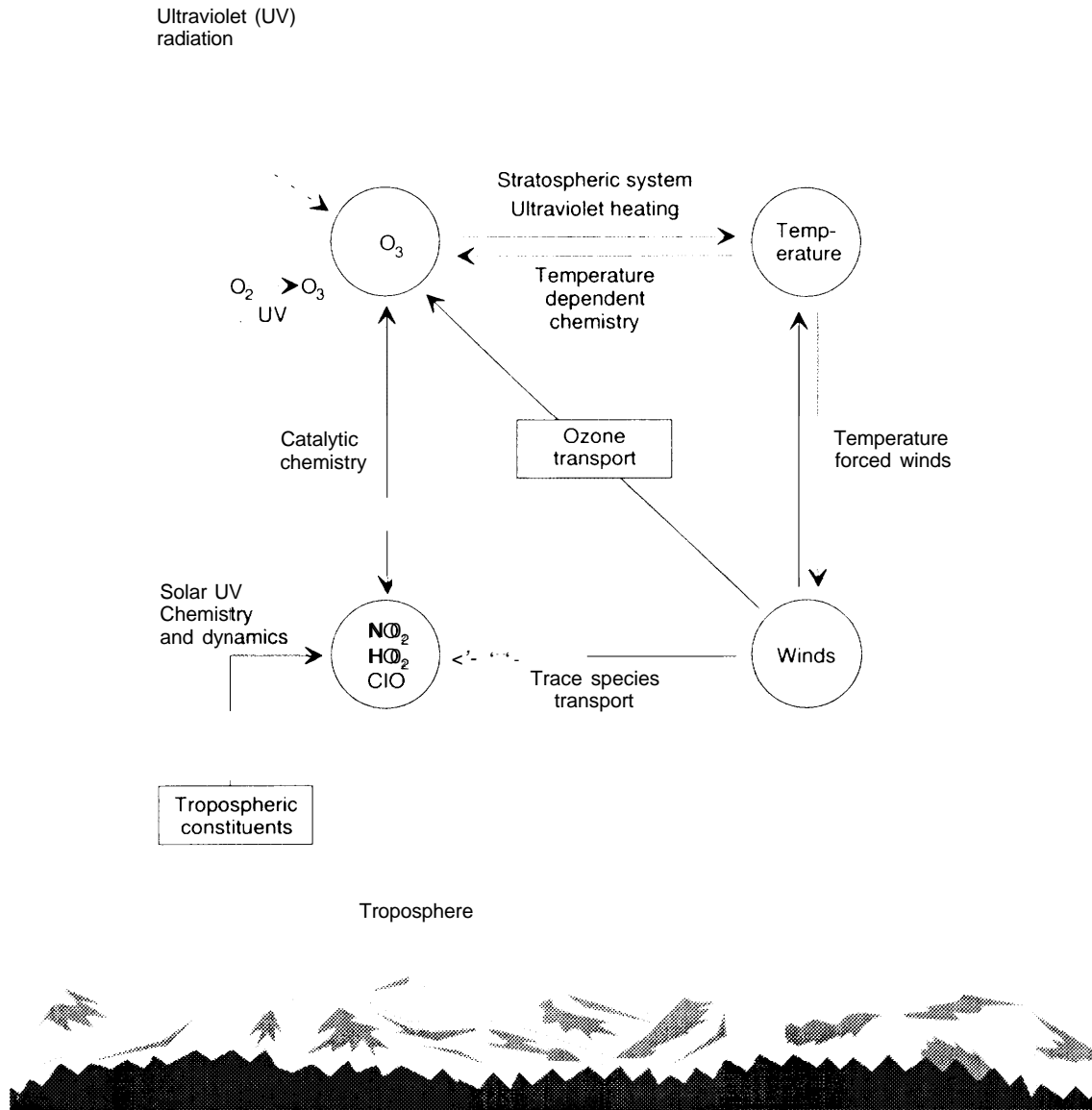

The arrows show interactions between imposition and atmospheric renditions. Maintenance of the stratospheric ozone layer, which shields terrestrial life from solar UV radiation, is of prime concern.

SOURCE: "Protecting the Ozone Layer," *Energy and Technology*, May, June 1990, p. 50.

different reasoning may account for the decision to defer instruments to monitor stratospheric chemistry and, in particular, ozone depletion (figure B-1). The United States and other nations had already agreed to steps that would phase out the use of ozone-depleting chlorofluorocarbons (CFCs). Furthermore, even without the EOS instruments, NASA officials could anticipate improvements in understanding of upper atmosphere chemistry and the mechanisms for ozone depletion as data from UARS, a precursor satellite to EOS, was combined and analyzed with data from groundbased, and in-situ balloon and aircraft measurements.

However, assessment of the success of efforts to stabilize ozone reductions may be hampered by the deferral of instruments to monitor the upper atmosphere. In addition, elimination of missions that might provide a detailed understanding of the fundamental processes that are causing ozone depletion in the lower stratosphere increases the risk that the United States and other countries will be unprepared to respond to future “surprises” with respect to ozone depletion.<sup>10</sup> Similarly, detailed process studies are necessary to measure the sources and sinks of carbon dioxide and other greenhouse gases. Without this knowledge, regulative and mitigative actions cannot be made with high confidence that the desired effect (for example, decreased rate of CO<sub>2</sub> increase) will occur as anticipated.<sup>11</sup>

U.S. policy makers are divided on the question of what, if any, steps the United States should take to reduce the emission of greenhouse gases.<sup>12</sup> EOS

instruments will supply some of the needed scientific data on the effect of greenhouse gases on global warming (box B-2). Ultimately, researchers hope to advance climate models to the point where reliable predictions can be made about the magnitude of global warming and regional effects. Policymakers regard this information as essential to guide adaptation or mitigation efforts. In contrast, although the physical and chemical processes governing the depletion of ozone in the upper atmosphere have many uncertainties, the international community has agreed to reduce CFC emission in hopes of reducing ozone depletion. This difference in approach is clearly related to the availability of relatively inexpensive alternatives to CFCs. Pressure to act despite uncertainty was also influenced by predictions that various CFCs would reside in the stratosphere for 50 to 150 years after emission. In addition, aircraft and satellite observations of a growing ozone hole in the Antarctic fueled public pressure for action to stabilize ozone levels.

Steps to mitigate the effects of ozone depletion or global warming will require financial or other sacrifices. The relative cost of these mitigative efforts may be highest in developing nations. Building an international consensus on the appropriate steps to mitigate **ozone depletion and possible global warming will require a USGCRP program organized to answer the most important scientific questions. “Good policy” is most likely to flow from “good science.”**

The rest of this section discusses three key instruments that were delayed or not funded:

---

<sup>9</sup> Solar ultraviolet radiation is the principal source of energy in the stratosphere and is responsible for many important **photochemical** processes. Ozone is concentrated in the stratosphere at altitudes between approximately 65,000 and 100,000 feet. The absorption of solar ultraviolet radiation by ozone is responsible for the increase in temperature with altitude that characterizes the stratosphere. The stratosphere is coupled to the lower atmosphere chemically (through **photochemical** processes), **radiatively**, and dynamically (various global circulation processes). See discussion and figure 4 in V. Ramanathan, Bruce R. Barkstrom, and Edwin Harrison, “Climate and the Earth’s Radiation Budget,” *Physics Today*, vol. 42, No. 5, May 1989, pp. 22-32.

<sup>10</sup> UARS is **not** a long-term monitoring satellite—its various instruments have expected lifetimes that range from **approximately 14 months** to 4 years. Currently, there is no planned follow-on to UARS. Although some of its instruments **will** fly on EOS platforms, a gap of several years in time-series of data is likely.

<sup>11</sup> Jerry D. **Mahlman**, “Understanding Climate Change,” Draft Theme Paper prepared for **Climate** Research Needs Workshop, **Mohonk** Mountain House, Nov. 8, 1991.

<sup>12</sup> **Policy Options for the United States are analyzed in U.S. Congress, Office of Technology Assessment, *Changing by Degrees: Steps to Reduce Greenhouse Gases*, OTA-O-482, (Washington, DC: U.S. Government Printing Office, February 1991).**

### Box B-2–The Greenhouse Effect

The Earth's atmosphere is composed of approximately 78 percent nitrogen, 21 percent oxygen, and a host of trace gases such as water vapor, carbon dioxide, and methane. Although these gases are nearly transparent to solar radiation, atmospheric water vapor, water in clouds, and other gases absorb about 20 percent of the incoming solar radiation. An additional 30 percent of the incoming solar radiation is scattered or reflected, especially by clouds, back into space. By contrast, the atmosphere is opaque to the less energetic infrared radiation emitted by the Earth's surface. About 90 percent of this heat energy given off the surface is absorbed by the clouds, water vapor, and trace gases such as CO<sub>2</sub>, methane, and chlorofluorocarbons that are being increased by human activities.

Once absorbed in the atmosphere, the heat energy is reradiated, much of it back to the surface which can be further warmed, leading in turn to increased heat emission to the atmosphere and further absorption and reradiation to the surface. In this way, clouds, water vapor, and other trace gases have the effect of warming the surface (however, as noted above, clouds also cool the surface by reflecting incoming solar radiation back to space). In fact, the recycled energy reemitted from the atmosphere to the surface is nearly twice the energy reaching the surface from the Sun. It is this "greenhouse effect" that makes the Earth's climate different from the Moon. The analogy is not perfect, however, because it suggests that the atmosphere and the glass in a greenhouse lead to warming by the same mechanisms of trapping and reradiation. A greenhouse actually stays warm because the glass keeps the atmospheric moisture from escaping (which is why effective greenhouses are always humid), thereby reducing the cooling effect of evaporation. Despite the difference in how the mechanisms work, the term "greenhouse effect" has stuck, providing us with a reminder that allowing continued increases in the concentration of trace gases (and associated increases in the water vapor concentration) will eventually lead to future warming.

**SOURCE:** Quotation from "Systematic Comparison of Global Climate Models," Lawrence Livermore National Laboratory, *Energy and Technology Review*, May-June 1990, p. 59.

### 1. LASER ATMOSPHERIC WIND SOUNDER—LAWS

LAWS is a proposed Doppler laser radar<sup>13</sup> that would allow direct measurement of tropospheric winds with high resolution. As conceived by NASA, LAWS would provide wind speed and direction at different altitudes in the troposphere every 100 square kilome-

ters to accuracies of 2 to 3 meters/second. Scientists would not only use this information in numerical weather prediction,<sup>14</sup> but also to understand a number of climate processes, including the transport of water vapor in the atmosphere and the heat, mass, and momentum coupling between the ocean and the atmosphere. In addition, if successful, LAWS would

<sup>13</sup> Also called **lidar**, for light radar. The Doppler shift is the change in laser frequency of the return, which is proportional to the scatterer's radial motion relative to the laser source. A familiar analog to this is the change in pitch that is heard as an ambulance siren or train whistle approaches and then recedes from a stationary observer.

In operation, a LAWS satellite would transmit a pulse of laser energy towards the Earth, some of which would be scattered back to the satellite by atmospheric clouds and aerosols. Scatterers in clouds and aerosols move with the local wind velocity. Therefore, wind velocities can be determined by analyzing the return signal's Doppler shift. The different altitudes at which the wind velocities are measured is determined by analyzing the round-trip travel time of the laser pulse.

<sup>14</sup> The input for numerical weather prediction models are maps of temperature, water vapor, and wind speeds and directions defined over a global network of model gridpoints. These maps, which may contain some 1,000,000 values, specify an "initial state" of the atmosphere. Numerical weather prediction consists of using model equations to advance this initial set of data to a new set at a later time. Current systems are limited in their capabilities because they lack access to global wind fields.

It might be thought that wind fields could be derived from temperature fields, which can be roughly determined with current satellite systems. Although there are dynamical relations between temperature fields and wind fields, wind measurements have more information than do temperature measurements, especially for the smaller scales of motion that are of key importance for weather prediction. Source: Cecil Leith, Lawrence Livermore National Laboratory, private communication.

allow the determination of the distribution of aerosols and cirrus clouds, and the heights of cirrus and stratiform<sup>15</sup> clouds.

As initially proposed, LAWS was a large instrument with a mass of some 800 kilograms. It would fly on its own platform and its solar power supply would be required to supply some 2,200 watts of continuous power.<sup>16</sup> A space-based laser wind sounder requires large amounts of power because of the necessity to transmit high-power laser pulses and because candidate lasers convert only a small fraction of their input electrical energy into laser light.<sup>17</sup> The LAWS proposal called for a pulsed, frequency-stable CO<sub>2</sub> laser transmitter operating at the 9.11 micron line of the CO<sub>2</sub> laser system;<sup>18</sup> a 1.5 meter transmit/receive telescope; and a cooled detector. The laser transmitter would produce pulses with an energy of approximately 15 to 20 Joules per pulse, with a pulse repetition rate that could be varied between 1 and 10 pulses per second.

NASA established a 5-year lifetime requirement for LAWS. With laser repetition rates of 5 to 10 pulses per second, this is equivalent to requiring reliability over approximately 1 billion laser pulses. The high cost of

LAWS (according to officials at GE Astro-Space Division, about \$600 million in 1991 dollars) and uncertainty about the ability of a space-based CO<sub>2</sub> laser to maintain its pulse rate over 5 years were among the chief reasons that NASA chose not to fund LAWS in the restructured EOS program. Efforts to demonstrate that a CO<sub>2</sub> laser can deliver billion shot lifetimes led to the demonstration, by GE in the summer of 1992, of 100 million pulses from a sealed, laboratory system. GE Astro-Space officials believe that by adding a small, lightweight (less than 5 kg) gas refill system containing ten laser fills a LAWS space-based laser could achieve one billion pulses.

Research into laser alternatives for the CO<sub>2</sub> laser is proceeding in many locations, especially DOE national laboratories. In principle, solid-state lasers should be less prone to failure than high-power gas CO<sub>2</sub> lasers.<sup>19</sup> However, another potential advantage—the reduction in requirements for laser energy or the size of telescope optics—is less certain.<sup>20</sup> Development of space-based solid-state lasers for a LAWS mission will require the resolution of a number of technical issues.<sup>21</sup> Some of these are associated with

---

<sup>15</sup> Stratiform clouds, in particular marine stratocumulus, significantly affect the surface heat budget and may be important in regulating climate. Because marine stratocumulus are associated with regions of large-scale subsidence, they are typically not overlain by higher clouds, and hence would be observable by a space-based laser wind sounder. Source: Dr. Michael Hardesty, NOAA Wave Propagation Laboratory, Boulder, CO, private communication.

<sup>16</sup> In an effort to reduce costs, a "descoped" LAWS has also been studied. This instrument would reduce the output power by a factor of 3-4 and reduce the telescope diameter to 0.75 meters. A LAWS science team meeting in Huntsville, AL, from Jan. 28-30, 1992, considered the science implications of building this instrument. They concluded that the descoped instrument could still measure tropospheric winds well enough to make important contributions to atmospheric general circulation models.

<sup>17</sup> For example, the "wallplug" efficiency of the baseline CO<sub>2</sub> laser is approximately 5 percent.

<sup>18</sup> More precisely, this is a line in the <sup>12</sup>C<sup>18</sup>O<sub>2</sub> isotope laser. This line is chosen because the reduced abundance of this isotope in the atmosphere minimizes atmospheric attenuation.

<sup>19</sup> For example, solid-state lasers would avoid the difficulties of designing a long-lived gas handling system. They would also avoid the possibility of failure from electrode "poisoning" —impurities introduced into the laser as a result of sputtering from the electric discharge electrodes. (However, based on the demonstration described above, GE researchers concluded that sputtering would not be a serious problem.)

<sup>20</sup> The laser energy and size of telescope optics for a laser radar are related to the efficiency of the detection process, which may be measured by the signal-to-noise ratio (SNR) coming out of the detector. The leading candidate solid-state laser operates at a wavelength near 2 microns. A longstanding, and still unresolved, debate within the community of researchers developing LAWS is whether this shorter laser wavelength system would have overall superior performance compared to the proposed 9.1 micron CO<sub>2</sub> laser system.

<sup>21</sup> These include the design of a system to provide the very accurate pointing of the narrow laser beam that is needed to ensure reception of the return signal. In addition, both the optics and the beam quality of LAWS would have to be near-perfect (i.e., near diffraction limited performance) because LAWS would use coherent detection to measure wind velocities. (Coherent detection mixes a stable frequency source with the return signal to generate a beat frequency that is proportional to the wind velocity.) CO<sub>2</sub> wind lidars with similar requirements for beam quality and optics quality have operated successfully on the ground for over a decade.

Several DOE national laboratories are also exploring the potential of noncoherent laser Doppler velocimetry, which would measure wind velocities without using coherent detection. Noncoherent methods have much lower requirements for pointing accuracy and beam quality. However, they may be less sensitive than coherent systems and they also have additional requirements, for example, the necessity to measure the amplitude of the transmitted and received beam precisely.

the development of the requisite laser crystals, semiconductor array pumps, and coherent detectors; others are related to the pointing and stability of the shorter-wavelength system. Eye safety is also an issue of greater concern at the operating wavelengths of the solid state laser than it is with the CO<sub>2</sub> laser.

Currently, only the CO<sub>2</sub> system is far enough into development for consideration in early EOS flights. An effort to find international partners for this system is underway; GE officials also are exploring potential collaborations among NASA, DOE, NOAA, and DoD.

## 2. SYNTHETIC APERTURE RADAR-SAR

NASA originally proposed a SAR for the EOS program because of its unique ability to make high resolution global measurements of the Earth's surface (see box B-3), but decided not to fund it because of its probable high cost (over \$1 billion in 1991 dollars). Operating at microwave frequencies, SAR radar returns are sensitive to the electrical and geometric properties of the Earth's surface, its cover, and its near subsurface. These data complement optical imagery and the combined data set may allow the study of such important Earth system processes as the global carbon cycle. Because SARS operate at microwave frequencies they are largely unaffected by clouds. This is particularly useful for monitoring the intensely clouded tropical and polar regions of the Earth. Operation during both day and night is also possible because SARS, like all radars, provide their own illumination in the form of radar energy.

SAR data could substantially improve the value of other EOS data. For example, researchers are particularly excited by the possibility of combining data from SAR about the physical properties of Earth's surface with data about chemical composition from HIRIS (see below). The combination would have the potential to date the ages of geomorphic surfaces and thus provide anew data set that would determine the rates of surface erosion and deposition.<sup>22</sup> A space-based SAR would also provide digital topographic data, vital for most hydrologic, geologic, and geophysical investigations. By using two antennas, SARS can be used in an interferometric mode to acquire global topographic data at resolutions on the order of 30 to 50 meters horizontal, 2 to 5 meters vertical.<sup>23</sup>

Synthetic aperture radar is a well understood technology with a long heritage of both civilian and military applications. The U.S. experience in flying space-based SARS for civilian applications began with the Seasat mission in 1978 and continued with SAR missions on Space Shuttle flights in 1981 and 1984 (Shuttle Imaging Radar-A & B). Currently, the Jet Propulsion Laboratory is preparing a third Shuttle imaging radar, SIR-C, for 1-week flights in 1994-1996 (box B-4). SIR-C will include a German and Italian X-band SAR (and is therefore sometimes referred to as SIR-C/X-SAR); the combination of systems will form a multiangle, multifrequency, multipolarization radar (a "color" SAR) that will demonstrate the technologies necessary for EOS SAR.<sup>24</sup> Foreign experience in space-borne SARS includes the two SARS currently in orbit. These systems, built and operated by Japan and Europe, are free-flying systems designed for multiyear

<sup>22</sup>B.L. Isacks and Peter Moughinis-Mark, "Solid Earth Panel," in *The Earth Observer*, vol. 4, No. 1, 1992, pp. 12-19. The *Earth Observer* is published by the EOS Project Science Office, Code 900, NASA Goddard Space Flight Center, Greenbelt, MD. As discussed below, budget cuts forced cancellation of HIRIS from the EOS program.

<sup>23</sup>Diane L. Evans, Jet Propulsion Laboratory, personal communication, Apr. 20, 1992. The essence of the interferometric SAR technique is to transmit a radar pulse and use the phase difference in signals received by two antennas, separated by a known distance, to infer ground elevations. The required distance between the separated antennas increases as the frequency is lowered. Thus, for example, L-band transmission would require locating receive antennas on two separate spacecraft. However, at Ka band, both antennas could be located on a single spacecraft (one located on a boom).

<sup>24</sup>The capability to vary radar incidence angle is necessary for measurements that require penetration to the surface, for example, in mapping forest clear cuts. SIR-C, which is being developed by the Jet Propulsion Laboratory for NASA, is a two-frequency, multi-polarization SAR that can vary its angle of incidence from 15° to 55°. SIR-C/X-SAR is a joint project of NASA, the German Space Agency and the Italian Space Agency and will be the first spaceborne radar system simultaneously to acquire images at multiple wavelengths and polarizations. X-SAR, which Germany and Italy are providing, is a single polarization radar operating at X-band (3 cm wavelength). It is mounted on a bridge structure that is tilted mechanically to align the X-band beam with SIR-C's L- and C-band beams. SIR-C/X-SAR is scheduled to fly aboard the Space Shuttle on 3 missions in 1994-1996 and will acquire seasonal data on vegetation, snow, and soil moisture.

### Box B-3-Synthetic Aperture Radar

Spaceborne radar systems may be classified in three general categories: imagers, altimeters, and scatterometers/spectrometers. Imaging radars are used to acquire high-resolution (few meters to tens of meters) large-scale images of the surface. They are used for the study of surface features such as geologic structures, ocean surface waves, polar ice cover, and land use patterns. A synthetic aperture radar is a special type of microwave radar—a “side-looking radar” (see figure B-2)—that achieves high resolution along the direction of motion of its airborne or spaceborne platform.

Radar resolution is usually defined as the minimum ground separation between two objects of equal reflectivity that will enable them to appear individually in a processed radar image. A sideways-looking radar has two resolutions: range resolution (“cross-track” resolution), which is perpendicular to the ground track, and azimuth resolution (“along-track”) resolution, which is in the direction of motion. Range resolution is determined by the length of the radar pulse because objects at different ranges can only be distinguished if their radar returns do not overlap in time. Azimuthal resolution is determined in conventional radar systems by the width of the ground strip that is illuminated by the radar, which is determined by the antenna beamwidth. Unlike conventional radar, the azimuthal resolution obtainable with a SAR is not determined by the size of antenna used in the measurement. A small antenna with a wide field-of-view can make high spatial resolution images by taking many closely spaced measurements.

Mathematically, an array of antennas is equivalent to a single moving antenna along the array line as long as the received signals are coherently recorded (i.e., phase information is retained) and then added. The SAR technique can be applied to spaceborne radar applications where the motion of the spacecraft allows a particular object on Earth to be viewed from numerous locations along the orbital path. It can be shown that the best azimuthal resolution on the ground using a synthesized array is equal to  $L/2$ , where  $L$  is the antenna length. This result is counter-intuitive because smaller antennas have higher resolution and because the ground resolution is independent of sensor altitude.

In his text on radar remote sensing, Charles Elachi notes that the fact that the resolution is independent of the distance between sensor and the area being imaged can be understood by noting that the farther the sensor is from the ground, the larger the footprint, and therefore the longer the synthetic array. This leads to a finer synthetic beam which exactly counterbalances the increase in distance.

The other surprise of synthetic aperture technique—finer resolution can be achieved with a smaller antenna—can be explained by noting that the smaller the antenna, the larger the footprint and the synthetic array. This leads to a finer synthetic beam, and therefore, finer resolution. However, smaller antennas gather less energy than larger antennas. Therefore, for maximum signal-to-noise in the detected signal, a designer may choose the largest antenna that is consistent with the minimum required resolution and the volume constraints of the instrument package. (Another way to increase the signal-to-noise would be to increase the time the SAR dwells in scanning a particular scene; however, platform speed in low-Earth orbit (approximately 7 km/s) places practical limits on this method.)

The return radar echoes received by a SAR are spread over a time that is proportional to the distance between the SAR platform and various features in the target. In addition, interference between signals reflected from various parts of the target will modify the amplitudes and the phases of the echo signal pulses. Thus, synthetic aperture radar signals are unintelligible in their raw form; they must be processed electronically to produce a useful visual display. Uncompensated motion during aperture synthesis causes a blurring of the resultant SAR image. Techniques to deblurr these images using novel image processing software/parallel computer processing are being developed with the support of DOE and DoD.

*(continued on next page)*

Spaceborne synthetic aperture radars can achieve ground azimuthal resolutions that are hundreds or even thousands of times better than those from a real aperture system. (In practice, the azimuthal resolution is often made equal to the range resolution.) However, they require very fast on-board electronic processing and high-speed data links to the ground. Data are generated at enormous rates in SARs—for EOS SAR, 180 Mbps peak, 15 Mbps, average.

Satellite-based SARs have their antenna, power, and data transmission requirements fixed by mission requirements such as spatial and temporal resolution and radar frequency. For example, the frequency and altitude of a SAR drive antenna size requirements; the required signal-to-noise ratio is an important factor in determining transmitter power requirements; and the size and resolution of the area to be imaged dictate the required data rate. Power requirements scale as the cube of altitude; power-aperture products scale with the square of altitude.<sup>1</sup> Power, size, and weight requirements may be relaxed for aircraft-mounted SAR. However, compensating for a platform that vibrates and may be buffeted by winds and changing atmospheric conditions poses new challenges. In addition, aircraft-mounted SAR have the endurance limitations common to all aircraft-mounted instruments.

<sup>1</sup> These factors are related by the "radar equation," which can be expressed in terms of the observed signal to noise ratio (SNR). The SNR is dependent on receiver performance. In addition it is proportional to the average transmitted power; the square of the antenna gain (proportional to area); the cube of the radar wavelength; the target radar "cross section," (a measure of target reflectivity); the cross-track resolution (which is related to the bandwidth of the radar processor and is therefore related to the noise); the inverse cube of the slant range to target; and the inverse of the spacecraft velocity.

SOURCES: Briefings to OTA, Jet Propulsion Laboratory, January 1992; Charles Elachi, *Spaceborne Radar Remote Sensing: Applications and Techniques*, (New York, NY: The Institute of Electrical and Electronics Engineers, 1995); and "Radar Images," in Sandia National Laboratory, *Sandia Technology: Engineering and Science Accomplishments, 1992*, pp. 32-33.

operation. A similar free-flying Canadian SAR is scheduled for launch in 1995.<sup>25</sup>

All current and planned foreign space-based SARs operate in single-frequency, single-polarization mode. In contrast, the proposed EOS SAR, like SIR-C/X-SAR, would be capable of making multiangle, multi-frequency, multipolarization measurements. These capabilities allow more information to be extracted from an analysis of radar backscatter and would give EOS SAR the potential to make global measurements of biomass, soil moisture, polar ice, and geology.<sup>26</sup> (Data from aircraft<sup>27</sup> and Shuttle-based experiments

combined with advances in modeling of radar backscatter signals will be necessary to demonstrate that biomass and soil moisture measurements over vegetated land can, in fact, be made precisely enough to be useful to global change researchers.) Multifrequency, multipolarization SARs have been developed for aircraft experiments, but until recently they have been considered too challenging and expensive to incorporate in a free-flying spaceborne system.

In principle, EOS SAR could have been used to monitor and characterize forest growth. Atmospheric CO<sub>2</sub> from forests is a key unknown parameter in the

<sup>25</sup> See ch. 4, *Surface Remote Sensing* and app. D for descriptions of existing SAR satellites.

<sup>26</sup> Foreign SARs have more limited capabilities for global change research compared to the proposed EOSSAR. The European ERS-1 operates in C-band (at 5.4 GHz). This frequency is especially suited for mapping sea ice and snow cover, but is not the preferred frequency for most EOS-class science missions. For example, studies of plant and soil moisture require lower frequency SARs because the lower frequency penetrates deeper into vegetation and soils. ERS-1 also does not have global coverage. The Japanese JERS-1 operates in L-band (at 1.3 GHz), and is preferred for more science missions. However, JERS-1 has relatively poor signal-to-noise ratio. Its principal scientific objective is to study geology. The Canadian Radarsat will be a single frequency and polarization instrument operating in C-band (at 5.3 GHz), and will have a wide swath width, but its principal application will be to monitor polar ice in the northern latitudes. (The Russian Almaz, which de-orbited on Oct. 17, 1992, was a single polarization instrument that operated at a frequency near 3.1 GHz in the S-band.)

<sup>27</sup> Airborne SARs include the Jet Propulsion Laboratory AIRSAR, a three-frequency polarimetric SAR that is providing prototype data for the Shuttle Imaging Radar-C (SIR-C) and the EOSSAR.



global carbon cycle.<sup>28</sup> EOS SAR would have complemented EOS MODIS, which will monitor CO<sub>2</sub> uptake in the oceans, by monitoring the extent of deforestation, the biomass of existing forests, and the successional stage of existing forests. Remote sensing studies of biomass in the tropical forest require a capability to sense both the forest canopy structure and the tree trunks underneath the canopy. Radar returns from the “C” band of EOS SAR would be sensitive to the canopy structure while the longer wavelength “L” band would be able to penetrate the canopy and give information about tree height, biomass, and canopy architecture.<sup>29</sup>

The principal impediment in developing EOS SAR is its high cost, a direct result of the requirements for a high-power system with a large antenna. The European Space Agency’s ERS-1 SAR cost nearly \$1 billion<sup>30</sup> and the Japanese JERS-1 cost approximately \$380 million. Early estimates of the cost of EOS SAR, including ground segment and launch costs, approached \$1 billion.

Cost reductions are possible if ways can be found to lower power and size requirements. Program managers for EOS SAR generally believe that reducing power, mass, and size requirements will result from investment in what are, in effect, engineering programs<sup>31</sup>—

scientists see no near-term technology ‘breakthrough’ that would change this conclusion. As noted earlier, program officials for both EOS SAR and LAWS raise concerns that government technology development efforts generally minimize funding for engineering and risk reduction programs and instead fund what is considered more basic science. Yet, investing in technology development may have significant payoff in more capable, lower cost technology.

Another option for EOS SAR would be to combine the data streams from a constellation of co-orbiting spacecraft, each carrying a single frequency SAR. The cost of each instrument might be reduced by using a standard instrument bus. **A more substantial opportunity for savings would come from international collaboration.** NASA and its sister agencies in Canada and Europe have begun informal discussions to explore the possibility of achieving the multifrequency capabilities proposed for EOS SAR through international partnerships. The European Space Agency (ESA) and Canada might provide C-band data (possibly with polarization diversity), the United States might provide L-band polarimetric data, and Germany might provide X-band data. To achieve the objectives of multitemporal observations and data continuity in the near term, the agencies have discussed develop-

---

~ The global carbon cycle describes the movement of carbon from its sources and sinks in the ocean, atmosphere, and land (e.g., ice pack, tundra, jungles, marshes). For example, during the day, plants take carbon dioxide from the atmosphere and convert it into organic compounds such as carbohydrates by using solar energy and water (the process of ‘photosynthesis’). Plants emit CO<sub>2</sub> during respiration, when they use the energy stored in these compounds. The balance favors the net accumulation of carbon in trees, shrubs, herbs, and roots. When forests are cut, the effect on atmospheric CO<sub>2</sub> depends on how much carbon was stored (i.e., total biomass), what happens to the cut wood, and how the lands are managed (e.g., new vegetation will take up CO<sub>2</sub> unless the site is converted to a reservoir, highway, or other nonvegetative state. Source: U.S. Congress, Office of Technology Assessment, *Changing by Degrees: Steps To Reduce Greenhouse Gases*, OTA-O-482 (Washington DC: U.S. Government Printing Office, February 1991), pp. 201-203.

<sup>29</sup> The SAR on the European ERS-1 has been limited in its capability to make soil moisture measurements, even though its frequency and incidence angle were specifically chosen for this application, because of the problem of differentiating between vegetation cover and ground moisture. EOSSAR would allow better separation of radar backscatter contributions from the Earth’s surface and its ground cover. In principle, a multiangle, multifrequency, multipolarization SAR would allow soil moisture to be distinguished from canopy moisture or soil moisture to be distinguished from vegetation moisture. (Successful tests have occurred in aircraft experiments; however, EOSSAR would have to be able to make similar measurements at an accuracy useful for global change.) The multiple frequency and polarization data of EOSSAR would be gathered simultaneously. This would allow researchers to monitor processes independent of diurnal or weather effects, for example, monitoring soil and canopy moisture, which will change from day to night or after a rainfall. Simultaneous measurements are also useful in monitoring ice in marginal ice zones.

<sup>30</sup> This figure includes the cost to develop, build, and launch the satellite and to construct a network of ground receiving stations and facilities. In addition, the cost includes development of supporting instruments such as the Along-Track Scanning Radiometer. The cost to build a second radar satellite that would be similar to ERS-1 and use the existing ground segment is approximately \$500 million.

<sup>31</sup> Although the component technologies for an EOSSAR are not new, the system possesses a number of unique requirements that stress design and add to cost. For example, special monolithic microwave integrated circuits (MMIC) with exceptionally linear response would be required. Similarly, specialized efforts would be needed to package SAR components in lighter weight and smaller structures. An attendee at OTA’S workshop on technologies for remote sensing noted that power efficient MMICs and lightweight antenna structures are examples of SAR-related technology that have suffered from lack of funding.

Figure B-2—SAR Observation Concept

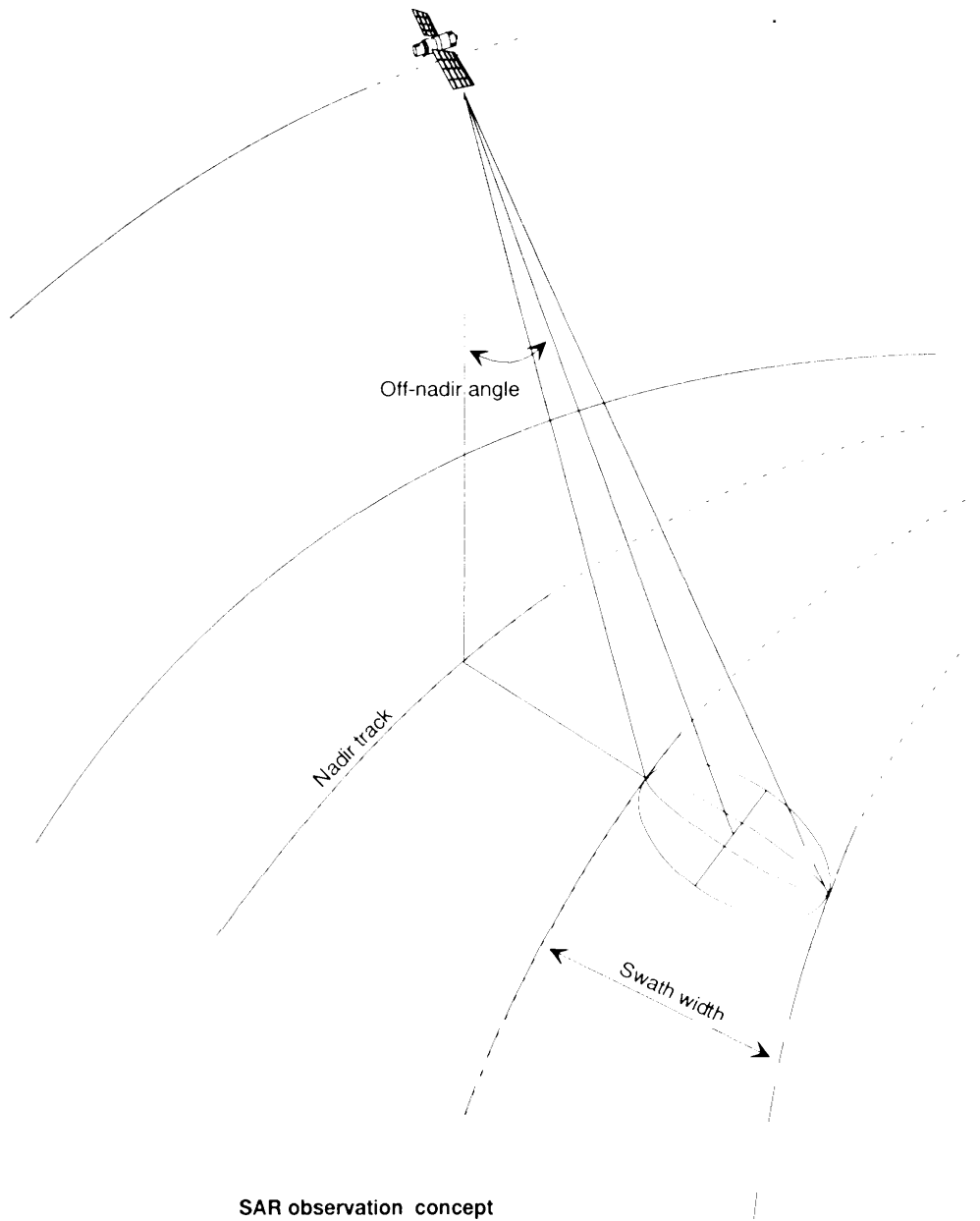

Signals collected from different orbital positions are merged to create a narrow synthetic aperture beam.  
SOURCE: Japanese Earth Resources Satellite-1 brochure, Japan Resources Observation System Organization.

ment of a SIR-C/X-SAR free-flyer in order to provide multiparameter SAR data prior to an EOS SAR mission. Discussions regarding exchange of science team members have been initiated in order to analyze these options further.

### 3. HIGH-RESOLUTION IMAGING SPECTROMETER—HIRIS

Since 1972, the Landsat series of satellites have imaged most of the Earth land surface at 80-meter and 30-meter resolution in several relatively broad visible and infrared spectral bands.<sup>32</sup> The reflectance characteristics of vegetation, soil, and various surface materials are sufficiently different that they can be distinguished by the relative strength of their reflectance in various combinations of these bands.

HIRIS was conceived as an “imaging spectrometer” capable of making much more refined measurements of the Earth’s surface than Landsat by acquiring simultaneous images of the Earth in hundreds of contiguous narrow spectral bands. In principle, analysis of HIRIS data would allow direct identification of surface composition; for example, identifying specific minerals, specific types of trees or ground cover, pollutants in water, and vegetation under “stress.”<sup>33</sup>

HIRIS would build on experience with the Airborne Visible and Infrared Imaging Spectrometer (AVIRIS), which became operational in 1988.<sup>34</sup> NASA’s original HIRIS proposal envisioned an instrument that would collect images in 192 narrow spectral bands (approximately 0.01 microns wide) simultaneously in the 0.4 to 2.5 micron wavelength region. This range, from the visible to the near-infrared, contains nearly all of the spectral information that can be derived from passive sensors collecting reflected solar energy.

NASA chose HIRIS’ spatial resolution to be 30 meters in part because of its use in vegetation research and geological mapping. For example, in forest

#### Box B-4-Shuttle Imaging Radar

NASA has flown two models of a synthetic aperture radar on the Shuttle, the Shuttle imaging radar, SIR-A and SIR-B. Both instruments collected thousands of images of Earth’s surface between +280 North and -280 South. SIR-C, an international effort that incorporates more advanced technology, is designed to fly on the Space Shuttle for 1-week experiments in 1994, 1995, and 1996. The United States is providing a dual-frequency quad-polarization radar operating at L-band and C-band frequencies; Germany and Italy will supply an X-band imaging radar. The combined 3-frequency system (sometimes referred to as SIR-C/X-SAR) is the latest in a series of Shuttle imaging radars designed to demonstrate the technologies necessary for an EOS SAR. SIR-C/X-SAR will be functionally equivalent to EOS SAR and will be used to identify the optimum wavelengths, polarizations, and illumination geometry for use by EOS SAR. However, EOS SAR would not be attached to a shuttle and would require an independent power source from solar panels. It would also have more stringent volume and weight constraints. On the other hand, if launched on an expendable launcher, a free-flying SAR would not have to have the safety requirements of systems that are rated for flight with humans.

SOURCE: Jet Propulsion Laboratory: Briefing to OTA, 1992.

ecosystems, successional changes in vegetation structure and function are linked to the size of gaps created by tree death, windfall, and other disturbances.<sup>35</sup> Thirty meters corresponds to the approximate size patch that develops in an Eastern hardwood forest when a tree is felled. It is also the approximate

<sup>32</sup> Longer time-series of data is available from the series of Advanced Very High Resolution Radiometer (AVHRR) sensors that have been orbited on TIROS polar satellites. AVHRR provides multispectral imaging (2 visible channels; 3 infrared channels), but at much lower resolution (1 km and 4 km).

<sup>33</sup> Alexander F. H. Goetz and Mark Herring, “The High Resolution Imaging Spectrometer (HIRIS) for EOS,” *IEEE Transactions on Geoscience and Remote Sensing*, vol. 27, No. 2, March 1989, pp. 136-144. Plant leaf spectral reflectance has been shown to differ when plants are stressed by a variety of agents including dehydration and fungus attack. See Gregory A. Carter, “Responses of Leaf Spectral Response to Plant Stress,” *American Journal of Botany*, 80(3): 239-243, 1993.

<sup>34</sup> A much more sensitive version of AVIRIS, HYDICE—hyperspectral digital imaging collection experiment—is being developed by the Naval Research Laboratory for aircraft flight in 1994. HYDICE will serve as a testbed for both the technologies that would enable HIRIS and for advanced aircraft-mounted sensors that could have military applications in land and ocean surveillance.

<sup>35</sup> Goetz and Herring, op. cit., footnote 33, p 138.

resolution needed in some geological applications and is roughly the minimum resolution necessary to detect roads. Even higher resolutions may be desirable, but the combination of hyperspectral imaging, relatively high spatial resolution, and requirements for large dynamic range<sup>36</sup> already stresses many aspects of instrument design, especially data handling and transmission.

HIRIS was originally scheduled for flight on the second EOS-AM platform in 2003. Faced with the 1992 reductions in the proposed outlays for EOS, NASA deleted HIRIS because of its high probable cost (more than \$500 million in 1991 dollars). Efforts to design a smaller, lighter, and therefore lower cost instrument are continuing. Proposals for a smaller HIRIS include reductions in required ground resolution (which reduces the size of instrument optics and peak data rates) and the use of active refrigeration to cool infrared focal plane arrays.<sup>37</sup> Establishing the cost of a smaller, lighter HIRIS is complicated by disputes over how much to budget to cover unanticipated costs associated with the introduction of advanced sensor technologies. Additional research is also required to establish the utility of HIRIS to support the highest priority missions of the restructured EOS program.<sup>38</sup>

## | Platforms: Issues and Tradeoffs

Each remote sensing mission has unique requirements for spatial, spectral, radiometric, and temporal resolution (box 4-B). Numerous practical considerations are also present, including system development costs; the technical maturity of a particular design; and power, weight, volume, and data rate requirements. As a result, the selection of a “system architecture” for a

remote sensing mission typically requires compromises and tradeoffs among both platforms and sensors. For example, some of the factors in determining system architecture for imaging of the land surface are the required geographical coverage, ground resolution, and sampling time-intervals. In turn, these affect platform altitude, the number of platforms, and a host of sensor design parameters.

## SATELLITE V. NON-SATELLITE DATA COLLECTION

Remote sensing instrumentation can be placed in space on platforms that have a variety of orbital altitudes and inclinations. It can also be flown on endo-atmospheric platforms: aircraft (e.g., NASA’s ER-2), balloons, and remotely piloted aircraft.<sup>39</sup> Finally, instruments can be sited at well-chosen locations on the Earth’s surface.

Satellites play a central role in global change research because they facilitate global, synoptic, and repeatable measurements of many Earth systems (box B-1). Thus, for example, satellite-based measurements are ideal for monitoring changes in global biomass, land use patterns, the oceans and remote continental regions, and global processes that have large amounts of small-scale variability, such as weather.<sup>40</sup> However, satellite-based measurements also have a number of limitations that only complementary remote sensing programs can address.

Orbiting above the atmosphere, a satellite-based remote sensing system gathers information about the Earth by measuring emitted or reflected electromagnetic radiation. These signals are then manipulated into forms that can be used as input data for analysis and interpretation. However, the process that converts

<sup>36</sup> Sensors capable of detecting signals that vary widely in intensity (large dynamic range) and characterizing signals freely (small quantization) are required to analyze scenes of widely varying reflectance and to characterize processes that may have only small differences in reflection.

<sup>37</sup> NASA has specified Stirling cycle mechanical coolers for EOS for approved or potential instruments such as AIRS, SWIRLS, TES, HIRDLS, and SAFIRE. Only the Oxford Stirling cooler is space qualified (a Lockheed mechanical cooler maybe space qualified in the near future—it is scheduled for flight in November 1994). Incorporation of mechanical coolers for EOS instruments will be possible only if current expectations for satisfactory cooling power, endurance, and vibration isolation are met.

<sup>38</sup> HIRIS was initially proposed when geological applications had a higher priority. HIRIS investigators have been asked to show that space-based imaging spectrometry can, in fact, monitor portions of the carbon cycle. Source: Berrien Moore III and Jeff Dozier, “Adapting the Earth Observing System to the Projected \$8 Billion Budget: Recommendations from the EOS Investigators,” Oct. 14, 1992, unpublished document available from authors or from NASA Office of Space Science and Applications.

<sup>39</sup> Some short-duration in-situ sampling of the atmosphere can also be accomplished using rockets.

<sup>40</sup> Satellite-based measurements are not necessary to measure variables whose distribution is approximately uniform, for example, the atmospheric concentration of CO<sub>2</sub>, which can be monitored at a few sites on the ground.

measurements into geophysical variables is often complex and data from nonsatellite measurements are necessary to reduce ambiguities in the analysis. Scientists also need to compare satellite data with surface-based or airborne measurements to verify that the satellite data are free of unforeseen instrument artifacts or unforeseen changes in instrument calibration. These comparisons are particularly important for long-term measurements and for measurements that seek to measure subtle changes. Satellite data must also be corrected to account for the attenuation and scattering of electromagnetic radiation as it passes through the Earth's atmosphere. In addition, corrections are necessary to account for the variations in signal that occur as a result of changes in satellite viewing angle.<sup>41</sup>

Another limitation of sensors on satellites is their capability to make measurements in the lower atmosphere. They may also be unable to make the detailed measurements required for certain process studies. For example, an understanding of the kinetics and photochemistry that govern the formation of the Antarctic ozone hole (and the role of the Antarctic vortex) has only been possible with in-situ balloon and high-altitude aircraft experiments.<sup>42</sup> Ground and in-situ measurements also help ensure that unexpected phenomena are not inadvertently lost as a result of instrument or analysis errors.<sup>43</sup> Satellite-borne sensors are also unable to measure climatological variables to the precision necessary for certain numerical weather and climate models, and their ability to determine temperature, moisture, and winds is inadequate for meteorologists interested in predicting, rather than just detecting, the formation of severe storms/hurricanes.

## UNPILOTED AIR VEHICLES

Researchers interested in elucidating mechanisms for ozone depletion are particularly interested in obtaining a stable, controllable, long-endurance platform that could be instrumented to monitor conditions in the upper atmosphere at altitudes up to and above 25 km (approximately 82,000 feet). Scientific explorations of this region are currently hampered by the uncontrollability of balloons, the inadequate altitude capabilities and high operating costs of piloted aircraft, and the inadequate spatial and temporal resolution of satellite-borne instruments.

Several recent studies have concluded that unpiloted air vehicles (UAVS) are capable of carrying instruments that would provide unique and complementary data to the NASA's EOS program and to the DOE's groundbased Atmospheric Radiation Measurement program.<sup>44</sup> For example, high-altitude UAVS would allow detailed studies of the mechanisms involved in the formation, maintenance, and breakup of the Antarctic ozone hole. In turn, this information could provide researchers with the tools to *predict* the onset of a similar hole in the Arctic. Positioning a UAV above a heavily instrumented site on the ground would also allow researchers to obtain accurate vertical profiles of radiation, water droplets, water vapor, ice particles, aerosols, and cloud structure-information that complements surface measurements and that is essential to test larger-scale models of atmospheric phenomena (UAVS would characterize processes occurring on a scale of General Circulation Model grid box, which is several tens of thousands of square kilometers).<sup>45</sup>

<sup>41</sup>See Jeff Dozier and Alan H. Strahler, "Ground Investigations in Support of Remote Sensing," *Manual of Remote Sensing: Theory, Instruments, and Techniques* (Falls Church, VA: American Society of Photogrammetry and Remote Sensing, 1983).

<sup>42</sup>J.G. Anderson, D.W. Toohy, W.H. Brune, "Free Radicals Within the Antarctic Vortex: The Role of CFCS in Antarctic Ozone Loss," *Science*, vol. 251, Jan. 4, 1991, pp. 39-46.

<sup>43</sup>The discovery of the "ozone hole" above Antarctica provides an instructive example of the importance of ground-based observations (box A-3).

<sup>44</sup>See Peter Banks et al., "Small Satellites and RPAs in Global-Change Research," JASON Study JSR-91-330 (McLean, VA: JASON Program Office, The MITRE Corp., July 13, 1992); U.S. Department of Energy, Office of Health and Environmental Research, *Atmospheric Radiation Measurement Unmanned Aerospace Vehicle and Satellite Program Plan*, March 1992 Draft (Washington, DC: Department of Energy, March 1992); and James G. Anderson and John S. Langford, eds., *Unmanned Aircraft: An Essential Component in Global Change Research*, version 1.0, June 1991, (available from authors). A popular article that discusses the potential role of UAVs in atmospheric research appears in Steven Ashley, "Ozone Drone," *Popular Science*, vol. 241, No. 1, July 1992, pp. 60-64.

<sup>45</sup>Water vapor and clouds are the dominant regulators of radiative heating on the planet, and uncertainty about the effect of clouds on climate is a source of fundamental uncertainty in climate prediction. Scientists have proposed UAVs for making some of these measurements.

**Table B-I-Specifications of Airborne Measurement Platforms and Proposed Conventional Research Aircraft**

Platform	Ceiling (km)	Range (km)	Endurance (hr)	Payload (kg)
McDonnell Douglas DC-8 (NASA) . . . . .	12	9,600	12.0	13,700
Cessna Citation (NOAA, UND) . . . . .	14	3,000	3.5-4.5	900
Gulfstream G-IV <sup>a</sup> . . . . .	16+	7,400	10.0	9,500
General Dynamics WB-57 . . . . .	21	4,000	7.0	1,800
Lockheed ER-2 (NASA) . . . . .	23	5,100	7.0	1,200

<sup>a</sup> Aircraft exists, but not currently equipped for atmospheric research.

SOURCE: Department of Energy, Office of Energy Research, Office of Health and Environmental Research, 1993.

UAVS are particularly suited towards making measurements at or near the tropopause, where the quality of remotely sensed data from both ground- and space-based platforms is poor. If developed, a long-endurance (multiple diurnal cycles) high-altitude UAV would effectively become a geostationary satellite at the tropopause. The tropopause is of particular interest because it marks the vertical limit of most clouds and storms.<sup>46</sup>

The instruments on UAVS can be changed or adjusted after each flight. UAVS are therefore potentially more responsive than satellite systems to new directions in research or to scientific surprises. Scientists have also proposed using UAVS as platforms for releasing dropsondes from high altitudes, a procedure that would provide targeted measurements of climate and chemistry variables at different altitudes in the atmosphere.

UAVS would be especially important in calibrating and interpreting satellite measurements. For example, scientists have proposed using UAVS to measure the angular distribution of solar and infrared radiation at tropopause altitudes, which is necessary to estimate flux and heating rates. Satellites are limited in their capabilities to make these measurements because they measure radiation from a limited number of angles.

Currently, researchers using satellite data employ elaborate models to reconstruct angular distributions of radiation; limitations in the models remain a source of fundamental uncertainty in Earth radiation budget measurements. UAVS would both augment and complement satellite measurements of the effect of cloud cover on the net radiation balance.<sup>47</sup>

High-altitude UAVS have a smaller payload capability than currently available piloted aircraft (table B-1). However, they have several advantages that make them particularly attractive for climate research:

- UAVS under design should reach higher altitudes than existing piloted aircraft. For example, the ER-2 can reach the ozone layer at the poles, but it cannot reach the higher-altitude ozone layer in the mid- latitude and equatorial regions that would be accessible to a UAV.
- UAVS can be designed to have longer endurance than piloted aircraft.
- UAVS should have much lower operating costs than piloted aircraft. For example, estimates of direct and indirect costs for the piloted high-altitude ER-2 aircraft total some \$15,000/hr of flight.<sup>48</sup> UAV studies predict savings of an order of magnitude or more.

<sup>46</sup> In the tropics, the tropopause can reach altitudes of 18 km. Monitoring the tropopause with airborne platforms therefore requires vehicles capable of reaching an altitude of some 20 km. NASA's piloted ER-2 can reach this altitude, but it is restricted to flights of 6 hours.

A long duration UAV flying at or below the tropopause would facilitate measurements of two quantities of fundamental interest. One, the angular distribution of radiation, is necessary for measurements of the Earth's radiation budget, but is difficult to measure with satellites (see discussion below). The other, the flux divergence, can be related to the net heating that is occurring in a particular layer of the atmosphere. It is a fundamental parameter that appears in global circulation models of the Earth's atmosphere and climate.

<sup>47</sup> Satellites fly above the Earth's atmosphere. A source of uncertainty in measurements of the effects of clouds on the net radiation balance is the relationship between the 'top of the atmosphere' infrared and solar fluxes observed by satellite and the fluxes at the tropopause, which are the fundamental quantities of interest. See Peter Banks et al., op. cit., footnote 44, pp. 37-41.

<sup>48</sup> Estimates from James G. Anderson, based in part on contract costs from Lockheed Corp.

**Table B-2—Specifications of High-Altitude Unpiloted Aerospace Vehicles**

Name	Status	Ceiling (km)	Range (km)	Endurance (hr)	Payload (kg)
Condor (Boeing) . . . . .	Exists	23	29,000	30	900
Egrett II <sup>a</sup> (E systems) . . . . .	Proposed	15	—	to be determined	900
Gnat 750-93L (General Atomic) . . . . .	Proposed	20	—	75-85	150-550
HILINE . . . . .	Proposed	13	—	18	45
Perseus-A (Aurora) . . . . .	Under development	30	900-1,250	1-4	50-100
Perseus-B (Aurora) . . . . .	Under development	20	13,000-19,500	36-72	50-200
Perseus-C (Aurora) . . . . .	Proposed	15	3,000-12,000	15-65	50-200
Endosat-B <sup>b</sup> (Endosat, Inc.) . . . . .	Proposed	20-30	50-100	months	100

<sup>a</sup> E-systems is the U.S. contractor for the German Egrett. Egrett II would be an unpiloted version of Egrett I, a high-altitude piloted vehicle that was used for border surveillance.

<sup>b</sup> Endosat would be powered by electrical energy generated by the rectification of a ground microwave source. Its range is limited to 50-100 km from the ground power source.

SOURCE: OTA; Aurora Flight Sciences Corp.; and Department of Energy, Office of Energy Research, Office of Health and Environmental Research, 1993.

- UAVS alleviate concerns about pilot safety on flights through polar or ocean regions.
- UAVS would be designed to fly at high altitudes at subsonic speeds. Supersonic high-altitude aircraft like the SR-71 (cruise altitude over 80,000 feet) are not suitable for many in-situ experiments because they disturb the atmosphere they are sampling (for example, the chemical species involved in ozone depletion).
- UAVS do not have the flight restrictions of piloted aircraft. For example, the ER-2 is restricted to daytime flight.
- The relatively low cost of UAVS compared to piloted aircraft should translate into more research aircraft and greater availability.

Table B-2 summarizes the characteristics of existing and proposed high-altitude UAVS. The altitude record for a propeller-driven UAV (67,028 feet or 20.4 km) is held by the Condor, a very large (200-foot wingspan, 20,000 pound) drone aircraft developed by Boeing for the DoD. The Condor has the range and payload capability to be useful to atmospheric scientists;

furthermore, proposals exist to extend its operating ceiling to even higher altitudes (researchers would like UAVS to fly at altitudes of some 80,000 feet; in fact, NASA studies call for the design of aircraft capable of reaching 100,000 feet).<sup>49</sup> However, Condor would be an expensive vehicle to buy and adapt for scientific research.<sup>50</sup>

Aurora Flight Sciences, a company founded in 1989, is developing low-cost, lightweight UAVS specifically for the atmospheric science community (box B-5). Closest to development is Perseus-A, a high-altitude drone capable of carrying 50-100 kg payloads to altitudes above 25 km. The first two Perseus aircraft are scheduled for delivery to NASA in 1994 at a cost of approximately \$1.5-\$1.7 million for each vehicle.<sup>51</sup> NASA, foundations, and private investors have supplied funds to Aurora for this work.

Both NASA and DOE (in its ARM program) plan to use UAVS for key experiments. In addition, the development of sensors for UAVS relates closely to the development of sensors appropriate for small satellites. Despite the potential of UAVs to enable measure-

<sup>49</sup> "Subsonic Airplane for High Altitude Research," NASA Tech Briefs, ARC-12822, Ames Research Center, Moffett Field, CA. The difficulty in designing a high-altitude subsonic aircraft is directly related to the challenge of designing propulsion systems, wing structures with sufficient lift, and heat transfer systems appropriate for operation in the tenuous reaches of the upper atmosphere. The density of air falls off rapidly with increasing altitude (an exponential decrease).

<sup>50</sup> Unofficial industry estimates provided to OTA suggest that restoring one Condor could cost \$20 million and yearly maintenance costs would be several million dollars or more.

<sup>51</sup> NASA may exercise an option for a third vehicle, which might lower unit aircraft costs. Aurora Flight Sciences Corp. is supplying a new existing ground station for use with Perseus A. Development of Perseus B is also proceeding at Aurora. It is being funded with internal monies and several small grants, including one from the National Science Foundation.

### Box B-5 The Perseus Unpiloted Aerospace Vehicle

Perseus A is designed to carry payloads of about 50 kg to altitudes of 30 km in support of stratospheric research. Perseus A will carry liquid oxygen to support combustion because air densities at 30 km are only some 2 percent those of sea level.

*Perseus B* would trade altitude for payload mass and flight duration. It would also replace the closed-cycle engine design of Perseus A with a two-stage turbocharged engine. This more complicated engine avoids the payload penalty incurred by carrying on-board oxidant and is the key to long endurance.

Perseus C would be designed for mid-latitude meteorological research and be capable of carrying 100 kg payloads to altitudes of 12-15 km.

SOURCE: Perseus Payload User's Guide, Aurora Flight Sciences Corp., 1992.

ments crucial to the global change research program, congressional support for civilian UAV development, and associated instrumentation, has been meager and may be inadequate to provide a robust UAV capability.<sup>52</sup> If it wishes to encourage innovation in global change research, Congress may wish to increase funding for the development of UAVS specifically designed for USGCRP missions. Because UAVS could be highly cost effective, moderate funding increases of only a few million dollars per year could ultimately lead to a major increase in UAV availability for research.

### THE ROLE OF SMALL SATELLITES IN EARTH OBSERVING PROGRAMS

"Small" satellites have been defined as costing \$100 million or less including spacecraft, instruments, launch, and operations. As noted in ch. 5, NASA, DOE and ARPA are examining small satellite systems for three roles in the U.S. Global Change Research Program:<sup>53</sup> 1) to address gaps in long-term monitoring needs prior to the launch of EOS missions, 2) to provide essential information to support process studies prior to, and complementary with, the restructured EOS, and 3) to allow for innovative experiments to demonstrate techniques that greatly improve the ability to monitor key variables or improve/speed up the process studies.<sup>54</sup>

Small satellites have three advantages as complements to larger systems. First, they are characterized by relatively low cost compared to larger satellites.<sup>55</sup> This facilitates 'risk taking' and encourages technical innovation. Small satellite proponents see this advantage as the key to enabling rapid, affordable augmentation and modernization of larger satellites. Second, small satellite missions can be developed in only a few years or less. Typically, development of a small satellite avoids the potential problems associated with managing the integration of multiple instruments on a single platform. Shortening the time to launch would add resilience to the satellite portion of the global change research program, large parts of which are frozen in development some 10 years before flight. Third, flying only a small number of instruments per satellite allows orbits to be optimized for a particular set of measurements.<sup>56</sup>

<sup>52</sup> For example, although the FY 93 USGCRP report to Congress gave strong support for a \$10 million dollar new start by the DOE to develop a UAV program, tight budgets prevented its implementation. For further information, see *Our Changing Planet: The FY 1993 U.S. Global Change Research Program* (Washington DC: National Science Foundation, 1992), p. 71.

<sup>53</sup> See Committee on Earth and Environmental Sciences (CEES) of the Federal Coordinating Council for Science, Engineering, and Technology, *Report of the Small Climate Satellites Workshop* (Washington, DC: Office of Science and Technology Policy, May 1992).

<sup>54</sup> *Report of the Small Climate Satellites Workshop*, pp. 20-21. In addition to these missions, researchers at the Goddard Institute for Space Studies have proposed using small satellites for long-term (decadal-scale) monitoring in a program that would complement EOS.

<sup>55</sup> They also weigh less and do not require as expensive a launcher. However, launch costs are small compared to other EOS costs. Multi-instrument EOS AM and PM satellites, Landsat 6, Landsat 7, and proposed EOS facility instruments-LAWS, SAR, and HIRIS—require a launcher in the Atlas 2AS-class. Launch costs with an Atlas 2AS may be some \$130 million, but this is 20 percent or less of total system costs (which also includes ground segment costs).

<sup>56</sup> However, some missions require nearly simultaneous measurements by instruments that cannot be packaged on a single satellite. In this case, a larger platform carrying several instruments may be desirable. Another option would be to attempt to fly small satellites in close formation.

<sup>57</sup> For a more detailed discussion of this subject see V. Ramanathan, Bruce R. Barkstrom, and Edwin Harrison, 'Climate and the Earth's Radiation Budget,' *Physics Today*, vol. 42, No. 5, May 1989, pp. 22-32.



### Box B-6—The Effect of Clouds on the Earth's Radiation Budget

Clouds regulate the radiative heating of the planet. They cool the Earth by reflecting a large part of the incoming solar radiation, increasing the Earth's reflectance by approximately a factor of 2. They also warm the Earth because they absorb some of the long-wavelength infrared radiation (emitted by the warmer Earth below) as well as emit radiation back to space at the colder temperatures of the cloud tops. High clouds tend to cool the Earth while low clouds tend to warm it.

Measurements made with space-based detectors show that the heating and cooling effects of clouds are comparable in magnitude and are about a factor of ten larger than that expected for a doubling of CO<sub>2</sub>. **A key uncertainty in predictions of future climates is how cloud heating and cooling might change in future atmospheres that are likely to contain greater abundances of CO<sub>2</sub> and other trace greenhouse gases.**

SOURCE: V. Ramanathan et al., "Cloud-Radiative Forcing and Climate: Results from the Earth Radiation Budget Experiment" and John Vitko, Jr., Sandia National Laboratory, private communication, Jan. 25, 1993.

#### A SMALL SATELLITE "GA P-FILLER" -CLOUDS AND THE EARTH'S RADIATION BUDGET<sup>57</sup>

The effects of human activities on the planetary energy balance are a principal focus of climate change research. The Earth's energy balance or "radiation budget" consists of incident sunlight, reflected sunlight (e.g., from the tops of clouds), and radiation emitted back to space, primarily from the Earth's surface and atmosphere. The emitted radiation falls predominantly in the infrared and far-infrared portion of the electromagnetic spectrum. The radiation budget is directly related to climate because the balance between the absorbed solar energy and the emitted energy determines the long-term average global temperature. In addition, the temporal and spatial variations of the radiation balance are linked to the global circulation patterns of the atmosphere and the oceans.<sup>58</sup>

Lack of knowledge concerning how changes in cloud type and cover<sup>59</sup> affect the radiation budget is a

principal source of uncertainty in 1) predicting climate changes associated with anthropogenic increases in greenhouse gases; and 2) understanding past and future climate changes caused by variations in solar output or in the orbital characteristics of the Earth<sup>60</sup>.

Scientists have monitored the Earth's radiation budget with spaceborne instrumentation since the early 1960s.<sup>61</sup> The most precise measurements of the radiation balance and the effects of clouds (box B-6) were made with sensors that were part of the Earth Radiation Budget Experiment (ERBE) (box B-7). **long-term measurements of the radiation budget and related data are necessary to distinguish between anthropogenic and naturally occurring variations in Earth's climate. Continuing measurements of Earth's radiation budget, and the effect of clouds and aerosols, are necessary to establish a baseline that might guide future policy decisions.**

<sup>58</sup> Many coupled ocean-atmosphere-land interactions influence the radiation budget. For example, the intensity of radiation emitted from the land surface varies with surface temperature. However, surface temperature depends on such factors as the amount of incoming solar radiation, which is affected by atmospheric absorption and scattering (which can be altered by human induced greenhouse gas changes or by natural events such as volcanic eruptions), and the effects of clouds. Surface temperature is also affected by surface moisture (because the surface cools by evaporation), which in turn is affected by surface composition and the presence of surface vegetation. Cloud formation and distribution depend on a host of coupled ocean-atmosphere-land processes.

<sup>59</sup> These changes include the distribution and fractional cover over land and ocean, and changes in cloud altitude, latitude, and reflectivity. The optical reflectivity of clouds is itself a sensitive function of the detailed internal structure of the cloud, for example, the size and distribution of water droplets and ice crystals.

<sup>60</sup> Solar output has been measured since 1978 and has fluctuated by approximately 0.1 percent. As noted earlier, the Earth absorbs approximately 240 watts/m<sup>2</sup> of solar energy. Based on correlation of measured irradiance changes with visible features on the Sun, scientists suspect that solar irradiance may vary by several tenths of a watt per century. Changes of Earth's orbit (e.g., its eccentricity or the inclination of its spin axis) occur on time scales ranging from approximately 20,000 to 100,000 years. Source: Johan Benson, "Face to Face, Interview with James Hansen, *Aerospace America*, April 1993, p. 6.

<sup>61</sup> Andrew Careton, *Satellite Remote Sensing in Climatology* (Boca Raton, FL: CRC Press), pp. 206-209.

NASA plans to continue radiation budget measurements as part of EOS by flying radiation budget sensors on the U.S./Japan<sup>62</sup> satellite and on the AM-1 platform (the CERES instrument, a follow-on to ERBS). TRMM and AM-1 are scheduled for launch in 1997 and 1998, respectively. NASA plans related flights of SAGE,<sup>63</sup> the stratospheric aerosol and gas experiment, as part of EOS. NASA officials acknowledge the desirability of flying CERES and SAGE missions before EOS flights in the late 1990s, both to assure data continuity and to have instruments in place before the next occurrence of El Niño-type events in 1995-1997 (see box B-8).<sup>64</sup> Researchers would also like to have instruments in place to monitor climate-changing surprises such as the eruption of Mt. Pinatubo. However, NASA has not identified sources of funding for these missions.

Researchers attending OTA'S workshop on the future of remote sensing technology stressed that, to be

**useful, radiation budget sensor systems must have very high-quality calibration, long-term stability, and fully developed data processing systems. Similar concerns govern the ACRIM mission (see box B-9). Measurements taken on successive satellites must also overlap for a sufficient time period to allow the two systems to be intercalibrated.**

**Sensor requirements of fine calibration and long-term stability can be understood intuitively by observing that the radiation balance is the difference between large energy inputs and outputs. Therefore, relatively small measurement or calibration errors in incoming or outgoing radiation will lead to errors in the energy balance that would mask evidence of an actual change. Similarly, changes in the way raw data are converted to radiation intensities could mask small changes in the radiation balance.<sup>65</sup>**

**A small satellite that would include the CERES instrument is among a number of small satellites being**

<sup>62</sup>TRMM, the tropical rainfall measuring mission, will combine a NASA-supplied spacecraft with a Japanese launch vehicle. The payload for TRMM will be supplied jointly.

<sup>63</sup>SAGE I flew from February 1979 to November 1981. SAGE II has been flying on the ERBS satellite since October 1984, a period well beyond the instrument design life. Flights of SAGE III before the year 2000 were recommended by the Payload Advisory Panel of the EOS Investigators' Working Group in October 1992 because 'SAGE has demonstrated that it can monitor consistently and overlong term several parameters that are crucial to global change: a. vertical profiles of ozone, b. stratospheric and tropospheric aerosol loading, and c. water vapor in the upper troposphere and lower stratosphere. The SAGE ozone measurements are now a key component of the present monitoring of the changing stratospheric ozone; the aerosol measurements are crucial for assessing the variability of solar forcing to the climate system consequent to the sporadic and highly variable volcanic aerosols.' See Berrien Moore III and Jeff Dozier, "Adapting the Earth Observing System to the Projected \$8 Billion Budget: Recommendations from the EOS Investigators," Oct. 14, 1992, unpublished document available from authors or from NASA Office of Space Science and Applications, pp. 23-25.

<sup>151</sup> Earlier flights of SAGE III on a 'mission of opportunity' is advocated by EOS' Payload Panel Advisory Group. One such flight would be on a planned NOAA weather satellite that could accommodate SAGE without necessitating expensive modification of the bus or causing significant changes in the planned instrument package. NOAA's 'AM' TIROS series is a suitable candidate (it has a space where the SBW sensor is placed for "PM" flights); a 1997 launch might be possible if funding is identified. However, even if this gap-filling mission were launched, sampling of diurnal variations would still be lacking because NOAA weather satellites fly in polar, sun-synchronous orbits. To fill the potential gap in SAGE data and to supply data from inclined orbits, scientists have proposed flight of SAGE II on a planned 1995 Russian launch. As of June 1993, NASA officials had not identified funding for either of these options.

<sup>65</sup> Deriving radiation budget & from satellite-based instrument measurements is an extremely complex process that requires sophisticated models and computer programs. The steps involved in processing radiation data include:

- . Convert instrument counts to radiant energy at detector.
- . Unfilter that signal to the front end of the instrument (i.e., put back what was lost in the instrument's optical path). This correction is scene dependent.
- . Convert to radiance at the top of the atmosphere.
- . Convert radiance to flux using angular-directional models.

Robert Cess, "Science Context of Small Global Change Satellites or Perspectives From One Who Would Like To Have Satellite Radiometric Data Before He Retires or Expires," in Paul V. Dresler and Jack D. Fellows, co-chairman, *Collected Viewgraphs: A Supplement to the Report of the Small Satellites Workshop*, (Washington D.C.: Committee on Earth and Environmental Sciences, June 1992).

### Box B-7—Earth Radiation Budget Experiment (ERBE)

**ERBE (Earth Radiation Budget Experiment) is a NASA research instrument that consists of two parts. The first is a relatively wide fixed field-of-view instrument with four Earth-viewing radiometers and a Sun-viewing radiometer equipped with shutters. The Earth-viewing radiometers monitor outgoing Earth radiation in two bands: 0.2 to 5 microns (short-wave infrared) and 0.2 to 50 microns (broadband total). The second part of ERBE is a narrow field-of-view (instantaneous field of view of approximately 3°) three-channel (0.2 to 5.0, 0.2 to 5.0, and 5.0 to 50 micron) instrument that can be scanned. ERBE data allow an analysis of monthly and seasonal variations of the radiation balance at regional scales. They also allow an analysis of the effect of clouds on the radiation budget. As noted in the text, analysis of ERBE data to date has shown that the net effect of clouds is a small cooling of the Earth. Scientists are still unsure how the planetary energy balance will be affected by clouds in future atmospheres that are likely to contain higher concentrations of greenhouse gases such as CO<sub>2</sub>.**

To monitor the Earth's radiation budget properly, daily global data from two **polar orbits** (A.M. and P. M.) and a mid-latitude inclined orbit of 50-60 degrees are required. ERBE sensors flew on the Earth Radiation Budget Satellite (ERBS), which was launched by the Space Shuttle into a low-inclination, non-sun-synchronous orbit and the NOAA 9 and NOAA 10 operational weather satellites, which are in sun-synchronous polar orbits. These were launched in December 1984 and July 1986, respectively. Five years of data were collected before the last ERBE scanner failed in 1990.<sup>1</sup>

<sup>1</sup> Non-scanner measurements are continuing on the NOAA-9 and NOAA-10 and data are continuing to be archived. However, the ability to characterize the scene covered by ERBS, which is crucial in radiation budget measurements, is limited because the non-scanners have a relatively wide field-of-view. As a result, the data have limited utility compared to the data that was being provided by the ERBS narrow field-of-view scanner.

SOURCE: National Aeronautics and Space Administration and Office of Technology Assessment, 1993.

considered for joint missions among NASA, DOE,<sup>66</sup> and DoD (through ARPA). (However, as noted earlier, budget constraints and other difficulties have delayed implementation of these proposals.) NASA officials interviewed by OTA supported efforts by DOE and DoD for collaboration because interagency cooperation may be the key to ensuring the long-term support that is necessary for multidecadal missions such as ERBS. In addition, harnessing the expertise resident in DOE laboratories could accelerate the development of technologies that promise to reduce mission costs.

#### CLIMSAT: A SMALL SATELLITE COMPLEMENT TO EOS

The rationale for launching a series of small environmental monitoring satellite\*Climsat-was

discussed in ch. 5. The several decade record of high-quality data on CO<sub>2</sub> abundance in the atmosphere is a prototype for the kind of measurements that Climsat would perform (figure B-3). CO<sub>2</sub> change is a key climate forcing variable. In addition, the historical CO<sub>2</sub> record provides an important constraint on analyses of the carbon cycle and directs researchers to the kind of detailed measurements needed to understand the observed CO<sub>2</sub> change.<sup>67</sup> In the same way, Climsat's long-term monitoring of other global forcings and feedbacks would help bound the thermal energy cycle and direct researchers toward detailed measurements of climate processes (some of these measurements would be made in the EOS program).

<sup>66</sup> Research groups in the DOE have proposed to build and launch, by 1995, one or more small spacecraft equipped with radiation budget instruments similar to those now flying on ERBS, or with what they believe would be an improved sensor. The improved sensor, which would be designed by DOE, promises better capability in analyzing the spectral content of the received signals. DOE researchers believe their sensor would therefore allow a better understanding of climate forcing from, for example, CO<sub>2</sub> and water vapor. However, the importance of stability in instrument calibration and data analysis argue for a cautious approach when considering major departures from previous ERBE sensors.

<sup>67</sup> James Hansen, NASA Goddard Institute for Space Studies, personal communication, 1993.

### Box B-8-The Linkage Among Earth's Systems: El Nino and the Southern Oscillation

Coastal Peru is arid enough so that sun-baked mud is often used to build houses. In the neighboring ocean, intense upwelling pumps nutrients to the surface to create one of the world's richest fisheries. In late 1982 the nutrient pump shutdown, eliminating the local fishery. And the rains began: some normally arid zones received as much as 3m [118 inches] of rain within a 6 month period. Mud houses dissolved, and much of the transportation infrastructure washed away. Almost 1,000 years ago, a similar climatic disaster destroyed a prosperous agricultural civilization rivaling the Incas.

Peru was not alone: the impact of the strange climatic events of 1982-83 was global. In Indonesia, vast areas of rainforest were destroyed in fires spawned by a devastating drought. Australia experienced the worst drought in its recorded history: firestorms incinerated whole towns, livestock herds had to be destroyed, and production of cotton, wheat, and rice was sharply reduced. In Brazil, an exceptionally poor rainy season distressed the impoverished Nordeste region, while southern Brazil and northern Argentina were hit with destructive flooding. Throughout southern Asia, poor monsoon rains in 1982 reduced crop yields and slowed economic growth. China saw drought over the northern part of the country and unusual winter floods in the south, leading to major losses in the winter wheat crop. . . Severe winter storms rearranged the beaches of California; spring floods covered the streets of Salt Lake City. . .

The above paragraphs describe events that occurred as a result of an irregularly recurring pattern known as ENSO. The acronym combines its oceanographic manifestation in the eastern tropical Pacific, El Nino, with its global atmospheric component, the Southern Oscillation. ENSO is an irregular cycle with extremes of variable amplitude recurring every 2 to 7 years. The 1982-83 events are an instance of its warm phase. Events of 1988, including catastrophic flooding of Bangladesh, demonstrate the impact of the cold phase. Historically El Nino was the name given to the marked warming of coastal waters off Ecuador and Peru. It is now understood that during the ENSO warm phase the warming covers the equatorial Pacific from South America to the dateline, fully one-quarter of the circumference of the Earth (plate 8).

**SOURCE:** Mark A. Cane, *Geophysics Report: El Nino and the Southern Oscillation (ENSO)*, Lamont-Doherty Earth Observatory, Columbia University,

Although Climatsat is designed for long-term measurements, it would also address short-term issues.<sup>68</sup> These include:

- . Assessment of climate forcing resulting from ozone change versus forcing that results from changes in CFC concentrations.
- . Assessment of climate forcing resulting from anthropogenic tropospheric aerosol change versus CO<sub>2</sub> change.

- . Short-term tests of climate models/understanding (e.g., effects of volcanic aerosols).

Each Climatsat satellite would carry three instruments (box B-10). Versions of two of these instruments, SAGE ILI<sup>69</sup> (Stratospheric Gas and Aerosol Experiment) and EOSP (Earth Observing Seaming Polarimeter), are part of the current plans for EOS. However, first launches of these instruments may not occur until

<sup>68</sup> These issues are among those discussed in the Supplementary Report to the Intergovernmental Panel on Climate Change (IPCC) Scientific Assessment (an update of the 1990 report). The IPCC supplementary report concludes that stratospheric ozone depletion may be offsetting much of the greenhouse warming caused by CFCs. In addition, cooling by tropospheric aerosols from sulfur emissions may have offset a significant part of the greenhouse warming in the northern hemisphere during the past several decades.

<sup>69</sup> SAGE III is an improved version of SAGE II, now in orbit. It should increase the accuracy of aerosol, ozone, and water vapor measurements. It should also permit extensions of these measurements deeper into the troposphere.

**Figure B-3-Carbon Dioxide Concentrations in the Atmosphere**

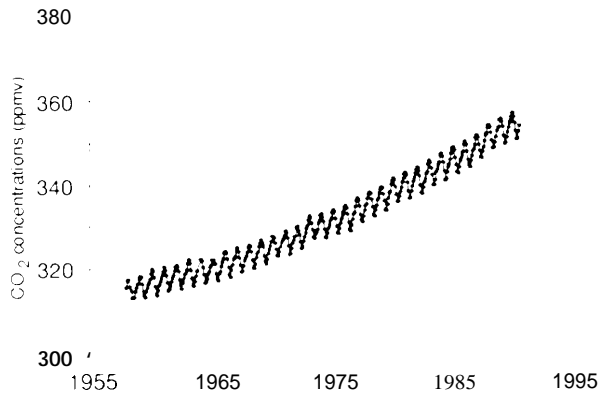

The Mauna Loa atmospheric CO<sub>2</sub> measurements constitute the longest continuous record of atmospheric CO<sub>2</sub> concentrations available in the world.

SOURCE: See Charles D. Keeling and Timothy P. Whorf, "Atmospheric CO<sub>2</sub>—Mauna Loa," in *Trends '91: A compendium of Data on Global Change*, Carbon dioxide Information Analysis Center, Publication ORNL/CDIAC-46 (Oak Ridge National Laboratory, Oak Ridge, TN, December 1991), pp. 12-14.

the year 2000 or later under the current EOS schedule.<sup>70</sup> The Climsat mission would have one satellite in sun-synchronous polar orbit and the other in an

inclined orbit that drifts in diurnal phase. Having SAGE III on both these satellites would provide global coverage and allow researchers to sample diurnal variations.<sup>71</sup> EOS might duplicate this coverage for SAGE III, assuming SAGE III flies to inclined orbit on a Pegasus in 2000 and to polar orbit on a multi-instrument platform around the year 2002. EOSP is currently scheduled for inclusion only on the second AM platform in (approximately) 2003.<sup>72</sup>

SAGE III was recommended for inclusion in EOS principally because of its capability to make high-accuracy measurements of the vertical distribution of ozone and stratospheric aerosols. These measurements will be made in a geometry that allows SAGE III to observe the sun or moon through the limb of the Earth's atmosphere. A dramatic example of the impact of aerosols on Earth's climate is the apparent global cooling effect of the June 1991 eruption of Mt. Pinatubo in the Philippines.<sup>73</sup>

EOSP measures the radiance and polarization of sunlight reflected by the Earth in 12 spectral bands from the near ultraviolet to the near infrared. Among the principal objectives of EOSP are the global measurement and characterization of tropospheric aerosols, surface reflectance, and cloud properties (e.g., cloud top height and cloud particle phase and

<sup>70</sup> Earlier flights of SAGE III on a "flight of opportunity" is advocated by EOS' Payload Panel Advisory Group. One such flight could be on a planned NOAA weather satellite that could accommodate SAGE without necessitating expensive modification of the bus or causing significant changes in the planned instrument package. NOAA's 'AM' TIROS series is a suitable candidate; a 1997 launch might be possible if funding is available. However, even if this gap-filling mission were launched, sampling of diurnal variations would still be lacking because NOAA weather satellites fly in polar, sun-synchronous orbits.

<sup>71</sup> A Climsat in a sun-synchronous near-polar orbit would provide a fixed diurnal reference. The second satellite would be placed into an orbit processing orbit inclined 50-60° to the equator. It would provide a statistical sample of diurnal variations at latitudes with significant diurnal change.

<sup>72</sup> An EOSP predecessor instrument that was launched on a mission to Venus allowed scientists to derive valuable data on cloud and haze characteristics and structure. However, the capability of EOSP to make similar measurements over Earth is complicated by Earth's more varied surface reflectivity and polarization characteristics, particularly over vegetated-covered land. As part of its plan to adapt EOS to funding of \$8 billion for 1991-2000, instead of \$11 billion, NASA accepted the recommendation of its advisory group to delay EOSP until the second AM platform in 2003.

Climsat supporters at the Goddard Institute for Space Studies argued against the delay in EOSP. Their reasons for believing EOSP could make the required aerosol measurements were based on both experimental and theoretical studies. These studies are detailed in J. Hansen, W. Rossow, and I. Fung, "Long-Term Monitoring of Global Climate Forcings and Feedbacks," Proceedings of a Workshop held at NASA Goddard Institute for Space Studies, Feb. 3-4, 1992, pp. 4&47.

<sup>73</sup> The plume from the eruption deposited great quantities of gases (e.g., SO<sub>2</sub>) and ash into the stratosphere where they produced optically significant quantities of aerosols that are expected to remain for several years. (Photochemical reactions convert the SO<sub>2</sub> to sulfuric acid, H<sub>2</sub>SO<sub>4</sub>, which subsequently condenses to form a mist of sulfuric acid solution droplets. Sulfate aerosol is a mixture of sulfuric acid and water). Because of their small size, these aerosols are more effective at reflecting shortwave solar radiation than they are at attenuating the longer wavelength thermal radiation emitted by the Earth. Thus, the aerosols alter the Earth's radiation balance by reflecting more of sun's energy back to space while permitting the Earth to cool radiatively at approximately the same rate as before the eruption. The result is a net loss of energy for the Earth atmosphere system, or a cooling of the atmosphere and surface. See P. Minnis et. al., "Radiative Climate Forcing by the Mount Pinatubo Eruption," *Science*, vol. 259, No. 5100, Mar. 5, 1993, pp. 1411-1415.

### Box B-9-Why Remote Sensing Places Particular Demands on Instrument Calibration and Stability

Much of global change research consists of establishing long-term records that will allow anthropogenic **changes to be distinguished against a background of naturally** occurring fluctuations. Therefore, measurements must be finely calibrated, instruments must have long-term stability, and data reduction and analysis algorithms must be well understood. Measurements of the Earth's radiation budget illustrate these requirements. Another example of the need for finely calibrated data in global change research is provided by the ACRIM (active cavity radiometer irradiance monitor) instrument to monitor long-term changes in the total solar output. This instrument is currently not on the EOS flight manifest, but **NASA** officials have stated their desire to fly ACRIM on a "flight of opportunity."

The interaction of the Earth and its atmosphere with the total optical solar radiation from the sun determines weather and climate. Even small variations in the total solar output would have profound effects on both weather and climate if they persisted. Scientific evidence exists for past climate changes, including cyclic changes ranging in period from the approximate 11-year solar activity cycle to many millions of years. Variations in solar output are suspected as the cause of some cycles, particularly short-term ones.

Acquiring an experimental database on solar variability is a necessary first step in testing hypotheses about how solar variability might affect climate. It is also necessary if researchers are to distinguish variations in solar output from other climate "forcings" such as changes in concentration and vertical distribution of infrared trapping "greenhouse" gases, aerosols, and clouds. Previous ACRIM measurements, beginning with the "Solar Maximum Mission" in 1980, have shown that solar luminosity varies with solar activity during the n-year solar cycle. Researchers would like to extend the ACRIM record base begun in the 1980 as part of the Earth radiation budget database for the Global Change Research Program. They would especially like to avoid gaps between successive ACRIM missions to "connect" (calibrate) readings between successive instruments and facilitate detection of subtle changes.

In his proposal for launching a new ACRIM mission before the mid-1990s,<sup>1</sup> Richard C. Willson, of the Jet Propulsion Laboratory, cites estimates that all the climate variations known to have occurred in the past, from major ice ages to global tropical conditions, could be produced by systematic solar variability of as little as 0.5 percent per century. Because the results of many solar irradiance experiments would be required to monitor the solar luminosity for 100 years, the relative precision of successive experiments would have to be small compared to 0.5 percent.

Researchers have adopted an overlap strategy that would deploy successive ACRIM experiments so that overlapping observation periods of approximately 1 year can be used to provide relative calibration of the data at a precision level (0.001% of the total irradiance) that is substantially smaller than their inherent uncertainty (0.1%). Although continuous data on solar luminosity has not existed long enough to detect the presence of sustained solar luminosity changes that might have climate implications, the long-term precision required to detect such a trend would **considerably exceed 0.1** percent.

<sup>1</sup>**NASA plans to fly ACRIM on EOS flights starting around the year 2002, but a potential gap in measurements exists for the approximate period of 1994-2002. The only ACRIM sensor now in orbit is on UARS, a satellite whose useful life is expected to end in 1994. UARS might exceed its design life, but recent problems with its battery power supplies also serve as a reminder that satellites can suffer premature failure.**

**SOURCES:** Office of Technology Assessment and Richard C. Willson, "Science Objective of an Active Cavity Radiometer Irradiance Monitor (ACRIM) Experiment on a Dedicated Small Satellite System," in Committee on Earth and Environmental Sciences (CEES) of the Federal Coordinating Council for Science, Engineering, and Technology, *Report of the Small Climate Satellites Workshop* (Washington, DC: Office of Science and Technology Policy, May 1992).

### Box B-10-Climsat Sensor Summary

SAGE III (Stratospheric Gas and Aerosol Experiment): an Earth-limb scanning grating spectrometer that would be sensitive from the ultraviolet to the near infrared. Yields profiles of tropospheric aerosols, O<sub>3</sub>, NO<sub>2</sub>, H<sub>2</sub>O, OClO—most down to cloud tops. Instrument mass: 35 kg; Power (mean/peak): 10/45 watts; Estimated Cost: \$34 million for 3 EOS copies (\$18M + \$8M + \$8M).

EOSP (Earth Observing Scanning Polarimeter): global maps of radiance and polarization; 12 bands from near UV to near IR. Yields information on aerosol optical depth (a measure of aerosol abundance), particle size and refractive index, cloud optical depth and particle size, and surface reflectance and polarization. Instrument mass: 19 kg; Power (mean/peak): 15/22 watts; Estimated Cost: \$28 million for 3 EOS copies (\$16M + \$6M + \$6M).

MINT (Michelson Interferometer): Infrared measurements between 6 and 40 microns. Yields cloud temperature, optical depth, particle size and phase, temperature, water vapor, and ozone profiles and surface emissivity. Instrument mass: 20 kg; Power (mean/peak): 14/22 watts; Estimated Cost: \$15-\$20 million for first copy.

**SOURCE:** J. Hansen, W. Rossow, and I. Fung, "Long-Twin Monitoring of Global Climate Forcings and Feedbacks," Proceedings of a Workshop held at NASA Goddard Institute for Space Studies, Feb. 3-4, 1992.

size). Characterization of clouds and aerosols is necessary for both climate models and to interpret signals received by satellite from the Earth's surface (e.g., by AVHRR and Landsat). For example, aerosols affect the transmission of electromagnetic radiation through the atmosphere and the clouds, but they are currently among the most uncertain of global climate forcings. Cloud cover and aerosol content are highly variable; like SAGE III, the argument for launching these instruments as part of Climsat, rather than EOS, is the additional coverage and better sampling of diurnal variations.

MINT (Michelson Interferometer) is the only Climsat instrument that is currently not scheduled for inclusion in EOS. MINT would measure the infrared emission from the Earth at high spectral resolution over a broad spectral range. Its principal measurement objectives include cloud temperature, transmissivity, particle size and phase (water or ice); temperature, water vapor, and ozone vertical profiles; and surface emissivity.

### | Developing Advanced Systems for Remote Sensing

The final section of this appendix draws on comments by participants at an OTA workshop on the future of remote sensing technology and briefings from scientists at NASA, DOE national laboratories, and industry.

NASA has identified a variety of high-priority technologies needed to enable or enhance future space

science missions, including EOS and the Mission to Planet Earth (box B-1 1). NASA's most urgent short-term technology requirements are for more sensitive long-wave infrared detectors, reliable cryogenic cooling systems, and development of submillimeter and terahertz microwave technologies. Mid-term requirements include new lasers, improved onboard data storage systems, and development of larger antenna structures. Long-term requirements, which are considered very important for the success of MTPE, include improvements in software and data analysis and in power systems. Improvements in software and data analysis are critical **to the success of EOS because scientists need to convert the raw data to information. Accumulating data is not equivalent to solving problems.**

Participants of OTA'S workshop on the future of remote sensing technology generally agreed that existing and planned efforts in technology development at the component level were sufficient to develop next-generation sensors. However, several participants expressed concern about the lack of commitment and funds to perform required engineering, integration, and prototyping of integrated, space-qualified sensors. This work is essential if the size, weight, and cost of space-based sensors is to decrease. Such efforts are particularly important for the large EOS "facility" instruments that were deferred or canceled—LAWS, SAR, and HIRIS. (One participant characterized the kind of development work that is necessary to develop

### Box B-11—Technology For Mission To Planet Earth

#### Direct Detectors

The particular need is for detectors capable of monitoring the interaction of the long-wave infrared thermal emission from the Earth with greenhouse gases—this requires detection of far-infrared photons in the 8 to 20 micron range.

#### Cryogenic Systems

**Cryogenic coolers are needed** to increase the sensitivity of infrared radiation detectors, particularly at long wavelengths. Stored cryogenics (e.g., liquid nitrogen) are not suitable for long-duration missions. Passive radiative coolers, which are mature technology, cannot be employed when extremely low temperatures are required or when there are geometric limitations (a passive cooler requires a large surface that never absorbs energy from the sun).

Mechanical cryo-coolers are miniature refrigerators. NASA plans to use tens of mechanical coolers during the 15-year EOS program. Concerns about their use include: their long-term reliability in a space environment; how to damp vibrations (NASA currently favors employing two matched cryo-coolers in a configuration where the vibrations of one cancel the other's); how to increase the efficiency of coolers (to provide sufficient cooling power); and how to reduce the cost of developing space-qualified units, which is currently measured in the million dollar range.

#### Submillimeter and Terahertz Microwave Technologies

The millimeter, sub-millimeter (frequencies above 300 GHz) and terahertz region of the microwave is of interest because this is the region where small, light molecules and free radicals of fundamental importance in the chemistry of the upper atmosphere can be monitored via their strong rotational emissions. Monitoring in this region also complements other techniques. For example, measurements taken with millimeter/sub-millimeter techniques are not affected by changes in aerosol or dust concentrations in the atmosphere (because the wavelengths are larger than the dust or aerosol particle size). In contrast, optical or ultraviolet measurements are strongly affected by aerosol and dust loading and therefore are sensitive to changes that resulted from the eruption of Mt. Pinatubo. Using techniques that are common to ground-based radio astronomy, researchers can analyze the strength and spectral width of molecular line shapes to determine the altitude and temperature distribution of molecules and radicals such as ClO, water vapor, nitrous oxide ( $\text{N}_2\text{O}$ ), CO, and  $\text{H}_2\text{O}$ .

Historically, sources and detectors for this region of the electromagnetic spectrum have been notoriously difficult to develop. At lower frequencies, up through the millimeter wave region, conventional klystrons and multiplication techniques may be used. Optically pumped far-infrared lasers provide a source of energy at higher frequencies, but only at a relatively few discrete laser frequencies.

#### Lasers

As noted earlier, development of a space-qualified high-power laser would allow the measurement of global wind velocities. It would also be a powerful method to identify and measure concentrations and vertical profiles

<sup>1</sup>Molecules are “excited” to higher energy states following collisions with other gas species. Emission of energy occurs when the molecule “relaxes” back to its normal energy state. The strength of the emission is a function of molecular abundance. In addition, because of “pressure broadening,” the spectral width of the emission contains information on the altitude distribution of the emitting molecule (pressure broadening occurs for molecules of interest at altitudes at pressures corresponding to altitudes below 70 km). See, for example, Alan Parrish, “Millimeter-wave Environmental Remote Sensing of Earth’s Atmosphere,” *Microwave Journal*, vol. 35, No.12, Dec. 1992, pp. 24-34.



of trace gases in the troposphere and stratosphere. In addition, it would allow accurate global measurements of altitudes and land surface elevations from space. Current research centers on the demonstration of reliability of CO<sub>2</sub> gas lasers and development of alternative solid-state lasers. Solid-state lasers require a laser "pump" to excite the upper energy level involved in laser action. Current research is focused on the development of diode-laser pumps because of their inherent reliability and energy efficiency.

LAWS is an example of a lidar (light detection and ranging, i.e., laser-based radar). New lasers are needed for lidars and for DIAL (differential absorption lidar). Important molecular atmospheric species such as oxygen, water, and trace species such as nitric oxide (NO) and the hydroxyl radical (OH) can be measured with great sensitivity using DIAL. Atmospheric temperatures and pressure can also be determined from an analysis of the molecular absorption line width and strength. Laser measurements of molecular absorption bands for species require tunable sources with extremely high frequency stability. For global use, systems must also operate at eye-safe levels or in eye-safe spectral regions. As mentioned earlier, laser velocimetry can be performed using either coherent or novel incoherent techniques. All of these issues are being explored in very active programs at DOE and NASA laboratories.

#### Onboard Data Storage Systems

EOS spacecraft will acquire enormous quantities of data. Onboard storage is necessary to manage these data—either to store data until satellite downlinks to Earth ground stations are available later in the orbit, or to facilitate data manipulation/compression to lower the required communication data rate to Earth. For example, the EOS AM-1 platform will acquire data at some 100 million bits/second (peak) and 16 million bits/second (average). Output of data at peak rates up to 150 million bits/second will occur when AM-1 is in contact with the TDRS satellite communications relay.

Near-term plans call for digital tape recorders to be used in EOS; however, the requirements of EOS spacecraft will push the limits of tape recorder technology. Current research is focused on developing alternative space-qualified storage systems, which would be smaller, lighter, more reliable (tape recorders have many moving parts), and better matched to the data requirements. Concepts under development include solid-state memories and optical disk technology.

#### Large Antenna Structures

Large lightweight antennas would facilitate development of affordable SARS.

#### Improvements in Software and Data Analysis

If current plans continue, the fully deployed EOS system of polar orbiters and other spacecraft are expected to acquire some 1-2 **trillion bits of data each day. Storing these data and translating them into useful information in a timely manner** is critical to the success of EOS. The SEASAT spacecraft (which included a SAR) operated for only three months in 1978, but scientists took eight years to analyze the data. A sizable fraction of the total EOS cost (currently at \$8 billion for this decade) is earmarked to solving the myriad of problems associated with data acquisition, analysis, and dissemination. OTA plans to publish a report on EOS data issues in late 1993.

#### Power Systems

Development of lighter weight and more energetic power systems would have a number of applications. In particular, when combined with lightweight, large antenna structures, the possibility exists for placing radar systems in higher orbits. Ultimately, researchers would like to place systems in gee-stationary orbit. Large antennas would be needed because the beam size on the Earth is inversely proportional to antenna size.

SOURCE: OTA and Robert Rosen and Gordon I. Johnston, "Advanced Technologies to Support Earth Orbiting Systems," paper IAF-92-0751, presented at the 43rd Cong. of the International Astronomical Federation, Aug. 25-Sept. 5, 1992, Washington, DC.

### Box B-12—ARPA Space Technology Initiatives in Remote Sensing

ARPA's Advanced Systems Technology Office has proposed several advanced technology demonstration (ATDs) that might point to remedies for key problems in the development of future space systems: lack of affordability, long development times, and high technical risk. ARPA program managers note that "our current practice is to custom-build large satellites on roughly 10-year cycles. To avoid unacceptable program risk, only proven or space-qualified technologies are typically incorporated. These technologies become obsolete even before the first satellite is launched ..."

Two ARPA ATDs have particular interest to the civilian remote sensing community: the Advanced Technology Standard Satellite Bus (ATSSB) and the Collaboration on Advanced Multispectral Earth Observation (CAMEO). ATSSB would be characterized by very high payload mass fraction and a simplified payload interface ("bolt-on") that would support a wide variety of missions while minimizing acquisition times and recurring costs. CAMEO is a proposal for a joint DoD/DOE/NASA collaboration to design, build, and launch a satellite using ATSSB that would carry instruments of interest to both civil and military users.

CAMEO would demonstrate the utility of smaller satellites to rapidly insert technology and shorten development time for larger satellites. It would carry three instruments:

- CERES, a NASA-developed instrument for albedo and Earth radiation budget measurements. CERES is an approved EOS instrument scheduled for launch in the late 1990s. Earlier versions of the CAMEO proposal considered a higher performance, but unproved, Las Alamos-designed radiometer.
- MPIR, a DOE-developed, very wide-field of view (90 degrees; swath width at nadir for nominal orbit altitude of 700 km is 1,000 km), pushbroom multispectral imaging radiometer. MPIR's principal objective would be to gather data for global change research, primarily albedo properties (e.g., cloud detection, identification, type, amount height, reflectance, optical thickness, and internal characteristics such as particle size and phase). Its 10 spectral bands would measure reflected sunlight and thermal emission from the Earth at visible/near-infrared to long-wave infrared wavelengths from 0.55-12 microns. Because MPIR's primary mission is measurement of cloud properties, high resolution is not necessary. The baseline proposal calls for a ground resolution of 2 km at nadir. MPIR would cool its medium-wave and long-wave infrared detectors to 60 K with an 600-milliwatt Stirling-cycle mechanical cooler. MPIR would be small (it would fit in a box 20 cm X 20 cm X 36 cm) and lightweight (25 kg). Its size and weight would also make it suitable for a flight on a UAV.

lasers for LAWS and SAR as "somewhere between exploratory and advanced development.")

Several researchers interviewed by OTA believed the lack of attention to engineering development was symptomatic of a larger problem: government interest and investment typically wane as a technology becomes more mature. However, schedule slips and cost overruns that occur during the final stages of instrument/platform development might be avoided by making a greater investment earlier in the development cycle, even if it is for what maybe perceived as lower priority engineering problems.

Currently, the time required between preliminary design and launch for a new, large, and complex satellite system may stretch to nearly a decade.

Workshop participants agreed unanimously that this period must be reduced for remote sensing systems. Similarly, workshop participants stressed the importance of reducing space mission costs. Unfortunately, the space community has not reached consensus on how best to achieve these goals. Box B-12 discusses ARPA's belief that space missions can be carried out with lower costs and shortened acquisition times by developing small satellites that would employ a small common satellite bus featuring standardized payload-bus interfaces. In particular, ARPA has proposed a joint collaboration among NASA, DOE, and ARPA to build and fly a gap-filling satellite to collect data for Earth radiation budget experiments. This satellite would also demonstrate technology applicable to

. LMIS, a DARPA-sponsored narrow field-of-view, high-resolution multispectral imager. LMIS would use pushbroom image formation and have a mechanically cooled focal plane. Notable among its characteristics is its hyperspectral imaging (32 bands) in visible/near-infrared bands. Other spectral bands would image the Earth in visible, short-, and medium-wave infrared. Resolutions would range from 2.5 meters in the panchromatic band to 20 meters in the medium-wave infrared. LMIS' swath width at nadir would be 20 km.

CAMEO's flight of CERES would avoid a likely gap in Earth radiation budget measurements while LMIS and ATSSB would demonstrate technologies for advanced imaging satellites. In particular, ARPA hopes LMIS and ATSSB would facilitate follow-ons in the Landsat series that would be lighter, smaller, less expensive, and incorporate a greater number of spectral bands. However, realizing all of these objectives in an imaging system similar to Landsat is likely to prove difficult, even if the CAMEO demonstration proved successful. For example, although the Thematic Mapper on Landsat 6 and Landsat 7 have fewer bands and somewhat lower ground resolution than proposed for LMIS, they also have a much larger swath width (165 km versus LMIS' 20 km). Whether it will be possible to develop a LMIS-type instrument with a wider field-of-view is one of many technical challenges. An ancillary issue that affects CAMEO and other proposed multispectral and hyperspectral imaging satellites is how best to use the added spectral information. Researchers in the satellite-based HIRIS program and in the aircraft-based HYDICE program are still at a relatively early stage in determining the capabilities of hyperspectral imaging.

ARPA's ATDs were fully supported by the DoD, but were severely cut by the Senate Appropriations Defense Subcommittee staff. The programs have been restructured for a fiscal year 1994 start and include an added new emphasis on the potential benefits of CAMEO in enabling the United States to develop and greatly expand its role in future commercial remote sensing markets.

SOURCE: Advanced Research Projects Agency, 1993.

follow-ons in the Landsat series and to global change research. Other proposals for small satellites and lightweight remote sensing instruments have been advanced by the DOE national laboratories (box B-13).

In an era of level or declining budgets, cost, not technology, may be the most important factor in determining which new remote sensing projects to fund.<sup>74</sup> **However, even without the pressure induced by recent budget cutbacks, programs that hope to address the fundamental questions associated with global change research in a timely manner will still have to evolve in the direction of "smaller, faster, better, cheaper."** Shorter project development periods and lower costs would better match the period over which scientific understanding improves, technology advances, and changes occur in the Earth systems under study.

As noted in chapter 2, the projected annual shortfall between NASA's planned activities and appropriations may increase throughout the decade. With multibillion dollar shortfalls, new development efforts for remote sensing technologies may be curtailed in an effort to maintain ongoing programs. Given this reality, one OTA Advisory Panel member suggested that NASA should institute a process to phase out approximately 15 percent of the base program per year to make room for innovation and new scientific/technical directions. This panel member further noted that because the current management approach is to key new ideas to budget appropriations, "new ideas rarely see the light of day."

Other researchers interviewed by OTA agreed that lack of funding for some programs might stifle future innovation in the future, but disagreed with the assessment that a problem currently exists. They

<sup>74</sup> This view is widely held; see, for example, Dean Freer, "Using Today's Strategic Defense Initiative (SDI) Technologies to Accomplish Tomorrow's Low Cost Space Missions," IAF-92-0752, paper presented at 43rd World Space Congress, Aug. 31, 1992, Washington, D.C.

### Box B-13-DOE Multispectral and Hyperspectral Imaging Systems

The Department of Energy is developing a variety of multispectral instruments for launch on small satellites to support ongoing efforts in global change research and to demonstrate technologies for nuclear proliferation monitoring. DOE's multispectral pushbroom imaging radiometer-MPIR was discussed in box B-12. This box summarizes characteristics of two other proposed DOE instruments: SIMS-small imaging multispectral spectrometer (formerly denoted as "mini-HIRIS") and the MT1-multispectral thermal imager.

The SIMS spectrometer is a joint NASA-DOE technology project to demonstrate that a small, lightweight instrument can obtain high spectral resolution images of modest spatial resolution that would be useful for global change research and non-proliferation missions. SIMS would have two grating spectrometers. It would operate in 5 nm contiguous bands from 0.4-1 micron and from 1-2.5 micron. SIMS would employ a 10 cm diameter telescope; its spatial resolution in the various bands would be 80-100 meters from its nominal orbit altitude of 700 km. As noted in earlier discussions of HIRIS, hyperspectral imaging with even modest spatial resolution can translate into enormous data rate and storage requirements. A 20 km X 20 km SIMS image would contain some 100 trillion bits. Data rate and storage requirements can be reduced, however, by selecting only a small subset of spectral channels for each scene.

The Multispectral Thermal Imager (MTI) is, in effect, DOE's version of ARPA's LMIS instrument (box B-1 1). MTI is a technology demonstration that is jointly sponsored by DOE's Sandia National Laboratory, Los Alamos National Laboratory, and Savannah River Technology Center. Its objectives are to collect high spatial resolution multi-spectral and thermal images for proliferation monitoring and to demonstrate technology applicable for future Landsats. However, in contrast to ARPA's proposal for CAMEO, MTI's development will not be tied to the development of a new standardized bus.

MTI would operate from 0.4-12 microns in 18 spectral bands. The instrument would fly in a nominal orbit altitude of 500 km with a 0.35 meter diameter telescope. Its spatial resolution would range from 5 meters in the 0.4-1 micron (VNIR) to 40 meters in the 8-12 micron band (LWIR). A separate linear array would be used for each spectral channel on a common focal plane assembly that would be cooled to 80 K with Stirling-cycle mechanical coolers.

noted, for example, that innovation and new scientific or technical directions have emerged out of existing efforts by several agencies, notably in the discovery and investigation of the Antarctic ozone hole. Furthermore, they believed that competitive peer review of grant proposals to agencies such as the National Science Foundation insured turnover in base programs.

### | Developing Follow-ons in Landsat Series

User requirements for surface remote sensing data can be grouped in four broad categories as shown in table B-3. The first grouping of requirements will be satisfied by the EOS system; the second grouping is satisfied by the current Landsat; and the third and

fourth groupings might be satisfied by advanced Landsats.

Landsat 5 was launched in March 1984. It has greatly exceeded its planned operational life and will be replaced by Landsat 6 in late 1993. Landsat 6 is similar in most respects to Landsat 5, differing most noticeably in its incorporation of an enhanced Thematic Mapper (TM) (table 4-1 ). The enhanced features of Landsat 6 include the addition of a 15-meter panchromatic (black and white) band, which can be used as a "sharpening" band for the 30-meter multispectral imagery and improved band-to-band registration (i.e., how well the same scene is recorded in different spectral bands). Landsat 7, scheduled for launch in the 4th quarter of 1997, would be the first

An example of a proliferation application for MTI would be to detect, monitor, and characterize the thermal signature from a nuclear reactor's cooling pond. This requires an infrared detection system that has relatively high spatial resolution. Other applications are noted below.

#### Nuclear Facility Monitoring Objectives

##### . Relevant Objectives

detect/identify proliferators as early in cycle as possible  
-assess capabilities: test or use?

##### . Production Reactor

-thermal power and duty cycle  
-total burnup  
-fuel cycle technology

##### . Nuclear Material Processing/Reprocessing Plant

-plant identification  
-process type  
-capacity  
—throughput

##### ● Enrichment Plant

-plant identification  
-process identification and capacity  
—throughput and duty cycle

##### ● Nuclear Device Fabrication/Storage Facility

-facility identification  
-material fabricated and duty cycle  
—storage area identification and location

<sup>1</sup>Increasing the resolution to 30 meters, the resolution of Landsat 5, would require increasing the aperture by approximately a factor of 10.

<sup>2</sup>SOURCE: Los Alamos National Laboratory, Space Science and Technology Division.

Landsat to incorporate stereo (table 4-2); it would also have higher resolution than Landsat 6.<sup>75</sup>

The first opportunity to depart from the current evolutionary approach to Landsat improvements will occur in Landsat 8, which, if approved, might be launched some five years after Landsat 7. Development of advanced Landsats presents familiar aspects of the debate over how to guarantee long-term continuity of measurements in an operational system, while still allowing for technical innovation. Because much of the value of Landsat for monitoring global change lies in its ability to collect comparable data over time, follow-on systems must either include existing spec-

tral bands or provide a method to reconstruct older Landsat data in software. This is possible using existing technology. (This assumes that an examination of Landsat data concludes that the original bands chosen for Landsat are still the most useful for Earth observation. Another option would be to discard some bands and retain only the several that are considered most important for continuity).

A more contentious issue centers on sensor design for Landsat 8 and beyond. The design of Landsat's detectors requires compromises and tradeoffs among spatial, spectral, and radiometric resolutions. Competing sensor concepts differ in their choice of optics

<sup>75</sup> The High Resolution Multispectral Stereo Imager (HRMSI), if funded, would have a ground resolution of 5 meters in the panchromatic band and 10-meter resolution in the new-infrared bands. This is a three-fold improvement over Landsat 6. The Enhanced Thematic Mapper (ETM+) planned for Landsat 7 also incorporates some improvements over the ETM for Landsat 6.

**Table B-3-Surface Data Requirements**

- 
1. **Wide-field, low-moderate spatial resolution**
    - . Global land survey
    - . Global ocean survey
  2. Medium-field, moderate-high spatial resolution
    - . Synoptic regional coverage
    - Landsat user community
  3. Narrow-field, high spatial resolution, stereo
    - Terrain elevation
    - Perspective views, flight simulation
  4. Narrow-field, high spatial and spectral resolution
    - Custom-tailored data acquisition
    - . Application specific
- 

**SOURCE:** A.M. Mike and C. F. schueler, "Landsat Sensor Technology," Briefing to OTA at Hughes Santa Barbara Research Center, January 1992.

(narrow or wide-field), scanning approach, and detector focal plane. Figure B-4 depicts the different approaches (note, direction of satellite is indicated by large arrow).

The simplest detector concept is to use a single detector for each spectral band. This is the approach used in NOAA's AVHRR. Landsat uses several detectors per band along the satellite track and scans these detectors (using a mirror) simultaneously across the satellite track. The scan rate is relatively high, but still much slower than if only a single detector had been used. NASA used this type of detector on the multispectral sensor (MSS) on Landsat 1-5, and also on the Thematic Mapper on Landsat 4 and Landsat 5. It will also be used on the enhanced TM on Landsat 6.

A simple detector array has several advantages. In particular, calibration of the sensor is relatively easy because only a few electronic channels need to be compared, and optics with a narrow field-of-view may be used because they image only across a short array. The principal disadvantage of this detection scheme is its limited "dwell time" (the time the detector is gathering signal from a particular location on the Earth). The limited dwell time restricts the signal-to-noise ratio at the detector and also requires "fast" detectors and associated electronics (i.e., detectors and electronics with high temporal frequency response). Small detector arrays also require scanning mirrors. While scanning mirrors have proved robust, a system without a mechanical seaming system would be more reliable and come closer to the ideal of a detector that

had only small numbers of electronic components and no moving parts.

The "pushbroom" detector concept, which has already been demonstrated on SPOT and on JERS-1, has been proposed for future Landsats. In the pushbroom concept, wide-field optics image a one-dimensional line image of the Earth onto a large linear array of detectors. The motion of the pushbroom along the satellite track generates a series of one-dimensional images, which are then added together electronically to form a two-dimensional image. Several advantages follow, principally that the scan rate is now slowed down (to that provided by the motion of the satellite moving in orbit+ .75 km/s for a satellite in orbit at 700 km). This greatly increases the time the detector "sees" the image, which results in a larger signal and therefore allows either greater spatial resolution or finer spectral resolution. The pushbroom concept also allows designers to craft a smaller, lighter instrument. Finally, the reliability of the pushbroom should be high because it doesn't use mechanical cross-track scanning,

The pushbroom design has two principal drawbacks. First, it requires much longer detector arrays, which have many more elements and are therefore more difficult and expensive to manufacture and calibrate (the number of detector elements for pushbroom linear arrays might number on the order of 10,000). Second, it requires optics with a wide field-of-view to obtain the same swath width as for the corresponding seamer. Pushbrooms were not chosen for Landsat 7 because the requirement for a 185 km swath width would have forced designers to use wide field-of-view optics. The SPOT satellite, which uses a pushbroom, avoids some of the difficulties of developing wide-field optics because its swath width is only 60 kilometers.

Pushbroom scanners are being considered for Landsat 8. A more ambitious proposal would replace the linear detector array of the pushbroom with a large two-dimensional detector array and use a 'step-stare' imaging scheme. A step-stare system would use image motion compensation to allow the array to stare at a particular patch on the ground as the satellite moves forward. The array would then be stepped to a new location and held again until it had imaged all the way across track. The advantages of this system are increased dwell time and necessity for only moderate

Figure B-4—Surface Optical Remote Sensing Techniques

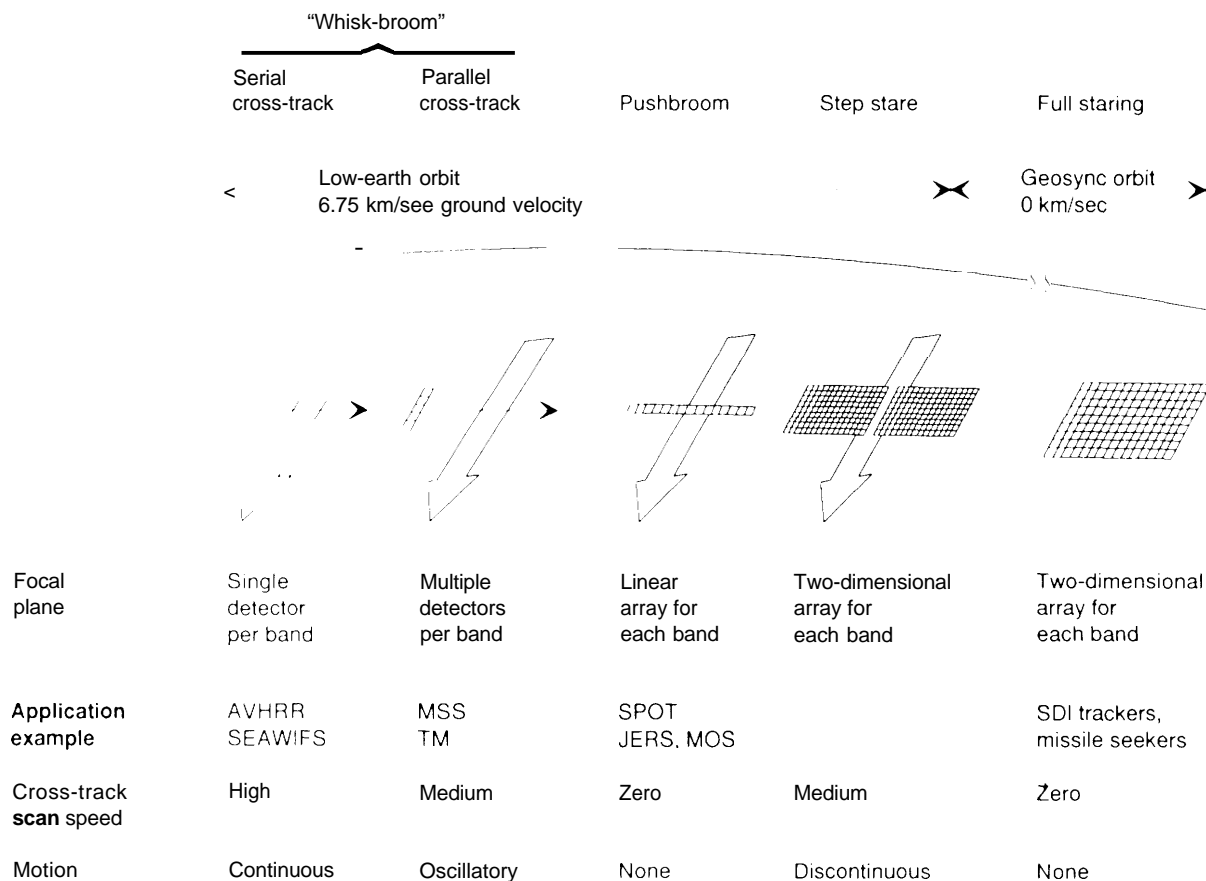

SOURCE: Hughes Santa Barbara Research Center Briefing Charts, 1992.

field-of-view optics. Its disadvantages are a larger and more complex focal plane than the pushbroom, which leads to greater problems in manufacturing, calibration and higher cost. Active mechanical cooling is also likely to be necessary to cool the array (passive radiative cooling may be possible for pushbroom detectors). The discontinuous motion also presents problems—the system has to settle between each step. A last option, which is not appropriate for Landsat, is a full stare system. Satellite velocities in low-Earth orbit are too fast to allow a full stare system to dwell long enough on a region of interest. Full stare systems could be used in geosynchronous orbits.

As noted at the beginning of this appendix, the risks in developing a new sensor system have two components: the technical maturity of component technologies and the design maturity. A particular design that has not been used before may be a relatively risky venture for an operational program, even if it is based on proven technology. Some concepts for advanced Landsats would stress both component maturity and design maturity.

A notable example of a new component technology that might enable the design of smaller, lighter, and less expensive land remote sensing instruments, with much greater spectral capabilities, is the linear spectral

wedge filter, the heart of a proposed "Wedge Spectrometer."<sup>76</sup> The wedge spectrometer, under development at Hughes Santa Barbara Research Center (SBRC), would be an extremely compact visible and infrared imaging spectrometer. A demonstration system has been fabricated; it **uses a 1 cm<sup>2</sup> linear spectral** wedge filter and detector array to gather a 128 X 128 pixel image in each of about 64 spectral bands in the visible/near-infrared region (0.4-0.85 microns).<sup>77</sup> SBRC has tested this system on an aircraft under ARPA sponsorship and generated image products.

The compactness of the wedge spectrometer is achieved in part because spectral discrimination occurs in a focused beam. In contrast, imaging spectrometers that use gratings or prisms to disperse light require collimating and reimaging optical and mechanical components. The wedge spectrometer is also thought

to be inherently cheaper and more rugged than grating or prism instruments. The key element of the system, the filter wedge, has been fabricated and is in use in devices such as laser warning receivers. However, the filter wedge in a laser warning receiver would not be suitable for calibrated remote sensing.

Officials at SBRC informed OTA of several spectral and radiometric performance issues that require further work so that a wedge spectrometer might be used in Earth remote sensing applications that require a high degree of radiometric and spectral sensitivity.<sup>78</sup> SBRC is currently under contract to the Defense Nuclear Agency to demonstrate the wedge spectrometer for treaty verification applications. SBRC expects to demonstrate the device operation in the short-wave infrared (SWIR) bands in calendar year 1993.<sup>79</sup>

---

<sup>76</sup> The key element of the Wedge Spectrometer is the linear spectral wedge filter; a thin-film optical device that transmits light at a center wavelength that is specified by the spatial position of illumination on the filter. (A thin film of oil selects light via a similar "interference" effect and accounts for the familiar rainbow of colors that are seen from varying thicknesses of an oil slick. The wedge filter is, in effect, an interference filter with a thickness that varies linearly along one axis.) Therefore, if an array of detectors is placed behind the filter, each detector will encounter light from a scene at a different center wavelength. If there is a linear variation in wavelength versus spatial position, the array output is effectively the sampled spectrum of the scene. An array of detectors behind the filter will vary spatially in one direction and spectrally in a perpendicular direction. Scanning the filter/array assembly along the spectral dimension will build a 2-dimensional spatial image in each of the spectral bands transmitted by the filter.

<sup>77</sup> The near-infrared is often defined as 0.4- 1.0 microns.

<sup>78</sup> A major issue for the filter wedge is improving "out of band" performance---currently, energy at wavelengths other than at the center wavelength specified by the spatial position of illumination on the filter may be passed. This energy undergoes multiple reflections within the filter substrate and results in inaccuracies in spectral information. Grating or prism systems are immune from this problem.

<sup>79</sup> The SWIR is often defined as 1.0-2.5 microns.



# Appendix C: Military Uses of Civilian Remote Sensing Data

This appendix addresses the *military utility of data from civilian remote-sensing satellites*. This utility draws the interest of those who might ignore the satellites and their more prosaic utility for Earth-sciences applications. Technically, it presses the satellites to their limits of resolution, both spatial and spectral, and timeliness. Politically, it raises questions of who should be allowed to buy what data. Militarily, it brings a whole new group of intelligence platforms, for what they are worth, into play for only their marginal cost. The Department of Defense has been purchasing remotely sensed data from EOSAT (Landsat) and SPOT Image (SPOT) for some time.<sup>1</sup> However, the extensive use of Landsat and SPOT data in the Persian Gulf Conflict has awakened public and congressional interest in the subject and focused attention on the issues involved.

This appendix does *not* address such questions as the civilian (scientific) utility of military satellites, or the “overlap” of civilian and military satellite capabilities. Thus, the sensitive question of the capabilities of military satellites does not concern us here—we need only investigate the capabilities of civilian satellites, and the question of how well those capabilities might serve military needs.

## | Military Remote Sensing Missions

Military remote sensing missions include reconnaissance (including broad area search, combat intelligence, indications and warning of war, and arms control verification); mapping, charting, and geodesy; and meteorology. While rule-of-thumb precepts quantifying the capabilities needed to perform certain tasks abound, we find them wanting and

---

<sup>1</sup>U.S. Congress, Office of Technology Assessment, *Remote Sensing and the Private Sector: Issues for Discussion*, OTA-TM-ISC-20 (Washington, DC: U.S. Government Printing Office, March 1984).

<sup>2</sup>Or *capability*—most such precepts reduce satellite capabilities to a single parameter, “resolution.”

prefer instead to be guided by instances in which specific satellites imaged specific targets of military interest, or targets like those of military interest. Seen in this light, even some of the least promising civilian satellites show surprising potential military utility.

## RECONNAISSANCE MISSIONS

Reconnaissance is “a mission undertaken to obtain, by visual observation or other detection methods, information about the activities and resources of an enemy or potential enemy.”<sup>3</sup> This mission dates back at least as far as the spies Moses and Joshua sent into the Promised Land,<sup>4</sup> and has traditionally been the province of unarmed or lightly armed scouts (like Joshua and his men), as well as cavalry, balloons,<sup>5</sup> and aircraft. Particular reconnaissance missions include (roughly in ascending order of difficulty) broad area search; indications and warning; combat intelligence; and arms control agreement verification.

**Broad Area Search**—This mission is the most unfocused reconnaissance possible: sweeping attention to an area of land or sea looking for previously undetected items of potential military significance, rather than for some particular military installation or formation. The enormous scope of the typical broad area search mission is, typically, somewhat offset by the large size of the targets of interest: when searching the hinterlands, one probably seeks clandestine or new military installations, indications of new military programs, and the like. Detailed examination of what one finds can be done later, with more focused coverage.

Broad area search is almost the norm for reconnaissance at sea: even in peacetime, ships and airplanes patrol the oceans to see whatever is there. While their efforts are largely focused on submarines, these difficult and yet important targets do not get all of the

attention; tracking of surface ships remains a vital mission in the United States Navy.

## Indications and Warning—Indications and Warning comprises:

.. those intelligence activities intended to detect and report time-sensitive intelligence information on foreign developments that could pose a threat to the United States or allied military, political, or economic interests or to U.S. citizens abroad. It includes forewarning of enemy actions or intentions; the imminence of hostilities; insurgent or other attack on the United States, its overseas forces, or allied nations; hostile reactions to United States reconnaissance activities, terrorists’ attacks; and other similar events.<sup>b</sup>

During crisis, rearrangement of aircraft, tanks, railcars, or ships within their basing areas, or their departure from their basing areas, could lead one to expect that an attack, or at the very least an alert, was underway. Vigilance regarding warning signs is a major intelligence mission for the United States. By its very nature, this mission must be performed continuously. Its intensity increases during periods of tension and crisis.

**Combat Intelligence**—Combat intelligence is “that knowledge of the enemy, weather, and geographical features required by a commander in the planning and conduct of military operations. It provides military forces with enormous leverage, and is a prerequisite for the American style of War,<sup>8</sup> and, indeed, for victory itself. “Knowledge of the enemy” includes the size and character of his forces, where they are and where they are not, the routes by which they are supplied, the extent of their logistic preparation for movement or combat, the nature of any fortifications they may occupy, and so on. It also includes the character of terrain and weather where operations might occur.

<sup>3</sup> *Department of Defense Dictionary of Military and Associated Terms* (Joint Pub 1-02, formerly JCS Pub1). This is the first definition of “reconnaissance.” The second is more general and includes mapping, hydrography, etc..

<sup>4</sup> *Numbers* 13: 1-25 and *Joshua* 2:1-24. (See also *Numbers* 13:27 and 13:28 for an early example of an “On the one hand ... , but on the other hand ... “ intelligence assessment.)

<sup>5</sup> Both crewed and otherwise. See Curtis Peebles, *The Moby Dick Project* (Washington, DC: Smithsonian Institution, 1991).

<sup>6</sup> *Department of Defense Dictionary of Military and Associated Terms*, op. cit., footnote 3, p. 177.

<sup>7</sup> *Ibid.*, p. 74.

<sup>8</sup> “No commander can succeed unless he demands and receives the intelligence and combat information he needs.” *United States Army FM 100-5, Operations*, August 1982, Washington, DC, p. 6-6.

Surprisingly, military weather *is* not quite the same as civilian weather. Civilian satellites presently make significant contributions to the military's weather forecasting: the military person's "theater" and the meteorologist "mesoscale" correspond to about the same spatial dimensions-on the order of a million square kilometers. But the knowledge of weather required for the combat intelligence mission can include scales of time and space not normally associated with weather forecasts, right down to the limiting case of informing a commander as to the current weather at his present location. Military meteorology also includes measurement of parameters seldom wanted or needed in the civilian world, such as direct measurement of rain rate.<sup>9</sup> Civilian weather satellites' deficiencies in satisfying military needs include: atmospheric sensing and observation capabilities, meteorological data acquisition and assimilation systems, and models needed to make reliable forecasts and "nowcasts" (descriptions of the weather within the coming day) of mesoscale weather with resolution of kilometers, extent of thousands of kilometers, and timescales of 6 to 72 hours. The military's goal of worldwide rapid response exceeds any current capability, military or civilian, for collecting data and turning them into a forecast. <sup>10</sup>

Some argue that the military's asserted need for its own weather satellite system, the Defense Meteorological Satellite Program (DMSP), stems from bureaucratic, not meteorological, concerns:

... there is considerable evidence to justify initiating action to converge the DMSP and TIROS systems. What has been lacking is sufficient impetus for the federal agencies involved to take such action.<sup>11</sup>

However, DMSP proponents can point to the woes of GOES-Next as evidence to support their position that

the military need for weather forecasting is too great to be left in the hands of any other organization.

**Monitoring Arms Control Agreements-Arms control agreement verification is:**

... a concept that entails the collection, processing, and reporting of data indicating testing or employment of proscribed weapon systems, including country of origin and location, weapon and payload identification, and event type. <sup>12</sup>

It also entails the evaluation of those data, and the consideration of them in light of a larger political context. Congress, particularly the Senate-in the exercise of its Constitutional mandate to advise and consent in the making of treaties-has made verifiability a prerequisite for most arms control treaties. While verification entails many ingredients other than those listed above (including political judgment-calls), the Joint Chiefs' list includes most or all of what arms-control theorists refer to as the "monitoring" part of verification; arms control agreement monitoring has become an important task for the U.S. intelligence community. Indeed, some have argued that this one task has preoccupied U.S. high-technology intelligence collection as a whole.<sup>13</sup>

## MISSIONS OTHER THAN RECONNAISSANCE

**Mapping, Charting, and Geodesy-**Tradition dictates the use of the word "map" by ground forces and the use of the word "chart" by naval forces, including each force's respective air arms.<sup>14</sup> **Geodesy** is the measurement of the shape of the Earth. The Defense Mapping Agency uses the phrase 'Mapping, Charting, and Geodesy' (MC&G) as the description of its principal mission,<sup>15</sup> defining the term *as follows:*

<sup>9</sup> Civilian meteorologists can let rainwater accumulate and then issue a report of the amount of **rainfall** recorded over a **certain** time. Military meteorologists can need to know instantaneous rain rate, because of its effect on radar systems.

<sup>10</sup> This paragraph draws on "Comments on Military Uses of Civilian Remote Sensing Satellites," Major General Robert A. Rosenberg USAF, (retired), Aug. 4, 1992.

<sup>11</sup> General Accounting Office, GAO NSIAD-87-107, *Weather Satellites*, p. 4.

<sup>12</sup> *Department of Defense Dictionary of Military and Associated Terms*, op. cit., footnote 3, p. 36.

<sup>13</sup> Angelo Codevilla, *Informing Statecraft* (New York, NY: Free Press, 1992), p. 112.

<sup>14</sup> The joint services *Department of Defense Dictionary of Military and Associated Terms* (Joint Pub 1-02, formerly JCS Pub 1) defines a 'map' as "a graphic representation, usually on a plane surface, and at an established scale, of natural or artificial features on the surface of a part or the whole of the earth . . ." p. 219.

<sup>15</sup> Defense Mapping Agency briefing to OTA staff, May 13, 1992.

MC&G is the combination of those sciences, processes and data which form the basis for preparing maps, charts and related products and for determining the size and shape of the Earth and its gravity and magnetic fields.

MC&G includes the collection, evaluation, transformation, generation, storage and dissemination of topographic, hydrographic, cultural, navigational, geographic names, geodetic, gravimetric and geomagnetic data. The data are manipulated to support air, land and sea navigation, weapon orientation, target positioning, military operations, planning and training.

Meteorology—Meteorological data are “meteorological facts pertaining to the atmosphere, such as wind, temperature, air density, and other phenomena which affect military operations.”<sup>16</sup> The military voraciously consumes weather data. These data are routinely needed for mission planning and assessment of possible enemy operations, and occasionally needed for such other tasks as predicting the coverage of chemical weapons and smoke from fires.

### Civilian Satellites and the Requirements of Military Remote Sensing Missions

To begin an evaluation of civilian satellites’ military utility, we need to compare their characteristics to the requirements of the military’s remote sensing missions. The previous section has treated the latter; we now turn to the former.

#### CIVILIAN SATELLITE CHARACTERISTICS

The most-discussed characteristic of remote sensing satellites is their imagers’ “ground resolution,” or ability to distinguish objects on the surface of the Earth. (See box 4-B.) Sensor characteristics other than resolution are often overlooked. These include scene size, the spectral range within which the sensor operates, the availability of stereo imagery, whether the pictures are digitized or not, the “metric” or accuracy with which the sensor knows and reports its own location, the timeliness with which the images are returned, the frequency with which a given target can be revisited, the fraction of the time that the system can devote to taking pictures,<sup>17</sup> the entire system’s throughput capacity, and the cost of the imagery. This section

**Table C-1—“Resolution” (ground sample distance) of Selected Civilian Satellites**

Satellite	Sensor	Resolution (in meters)
Resurs-F	KFA-1000, panchromatic or color	5 <sup>a</sup>
Resurs-F	MK-4 (multispec.)	6 <sup>a</sup>
SPOT	Panchromatic	10 <sup>b</sup>
SPOT	Multispectral	20 <sup>b</sup>
Almaz	Main SAR	15 - 30 <sup>c</sup>
JERS-1	8-band optical	18 × 24 <sup>d</sup>
JERS-1	SAR	18 <sup>d</sup>
Seasat-A	SAR	25 <sup>e</sup>
Landsat 4, 5	Multispectral	30 <sup>f</sup>
Landsat 4, 5	Multispectral	80 <sup>f</sup>
Landsat 6	Panchromatic	15 <sup>g</sup>
Landsat 6	Multispectral	30 <sup>h</sup>
Landsat 7	Panchromatic	5 <sup>h</sup>
Landsat 7	Multispectral	30 <sup>h</sup>
IRS-1a	Multispectral	36 <sup>d</sup>

<sup>a</sup> Allen V. Banner, *Overhead Imaging for Verification and Peacekeeping Studies: Three Studies*, prepared for the Arms Control and Disarmament Division (Ottawa, Ontario, Canada: External Affairs and International Trade Canada, 1991), pp. 7-8.

<sup>b</sup> *Ibid.*, p. 3.

<sup>c</sup> Hughes STX Corp., “Almaz-1 Synthetic Aperture Radar Data: An Overview” (Ref. No. 5132-92-HP), slide 10.

<sup>d</sup> Peter D. Zimmerman, *The Use of “Open Market” Observation Satellites for the Monitoring of Multilateral Arms Control Accords*, prepared for the United Nations Department of Disarmament Affairs, p. 21.

<sup>e</sup> Eli Brookner in *Arms Control Verification*, Kosta Tsipis, David W. Hafemeister, and Penny Janeway (eds.), p. 138.

<sup>f</sup> Banner, *op. cit.*, footnote a, p. 6.

<sup>g</sup> D. Brian Gordon, Chairman, Tactical and Military Multispectral Requirements Working Group, Defense Intelligence Agency, testimony of hearings before the House Committee on Science, Space and Technology and the Permanent Select Committee on Intelligence, 102d Cong. 1st Sess., June 26, 1991. *Scientific, Military, and Civilian Applications of the Landsat Program*, p. 46.

<sup>h</sup> EOSAT/GE.

addresses a variety of civilian satellite capabilities, albeit with resolution as the first among equals (table C-1).

The basic image parameters-spatial resolution, scene size, spectral resolution, and spectral coverage-compete for satellite resources. Fixed or expensive-to-change constraints such as the data capacity of the downlink, the ‘speed’ of the sensor optics, and ultimately the weight of the satellite itself, place upper

<sup>16</sup> *Department of Defense Dictionary of Military and Associated Terms*, *op. cit.*, footnote 3, p. 227.

<sup>17</sup> As opposed to performing other activities, such as sending down to an Earth station the pictures that have already been taken.

limits on the amount of information the image can contain. Within those limits, tradeoffs must be made so as to maximize the image’s utility for its intended purpose. A multipurpose satellite entails another level of tradeoff, compromise among purposes. A civilian satellite, especially a commercial one, is intended to be all things to all customers, and thus will not necessarily fill any one customer’s bill perfectly.

**Resolution----**One often sees the optical acuity of remote sensing systems expressed in terms of the *ground resolution* (or ‘ ‘resolution,” or “ground sample distance”) of their imagery-the closest that two objects can be and still be perceived as two separate objects. <sup>18</sup> In practice, it is usually about **twice the size** of the smallest item that can be perceived as a separate object.

Many sources in the open intelligence literature tabulate the utility of different ground resolutions (table C-2).<sup>19</sup> These sources generally list various objects and the ground resolutions needed to perform various tasks with respect to these objects, such as “detection, “recognition, ’ “identification, and “technical analysis. ’ For example, 9-meter resolution allows the detection of a ship, but 3- to 4-meter resolution may be needed to determine the type of the ship (e.g., “submarine’ and even finer resolution is needed to determine its class (e.g., *Oscar*). *The* many sources, some quoting from others, show rough agreement as to the resolutions needed for the different tasks.

A more sophisticated expression of sensor definition, the Image Interpretability Rating Scale (IIRS),

Table C-2—Resolution Requirements (in meters)  
Sorted by Task and Target

Target	Task		
	Detect	Identify	Analyze
Surface ships . . . . .	15	0.15	0.04
Land minefield. . . . .	3	0.30	0.08
Missile sites . . . . .	3	0.15	0.04

SOURCE: McDonnell Douglas, *Reconnaissance Handy Book*, 1982, p. 125.

takes into account aspects of image quality other than ground resolution. These include contrast, intensity, shadowing, and so on. The IIRS is, at base, a subjective rating system: it works *from the image’s utility* in detecting, identifying, or analyzing given types of target to the image’s rating on the scale.<sup>20</sup>

Both IIRS and the more objective (but simplistic) ground resolution paradigm address the utility of images. However, the tasks to which they refer are of the most rudimentary nature. Military consumers of remotely sensed data are really not interested in detecting, identifying, or analyzing particular objects. They care about such tasks as mapping, forecasting, targeting, and verifying. The ground resolution needed to perform these tasks is not so clear-cut, and deficiencies in image quality can in some cases be made good by virtuoso performance of the image interpreter’s art. For example, ships too small to be seen at a given resolution could, if under way, be detected via their wakes. Fences, themselves an

<sup>18</sup> The *Department of Defense Dictionary of Military and Associated Terms (Joint Pub 1-02, formerly JCS Pub 1)* defines “resolution” as “a measurement of the smallest detail which can be distinguished by a sensor system under specific conditions.” The role of the word ‘ ‘distinguished” in this definition is sometimes given insufficient emphasis.

<sup>19</sup> These include:

McDonnell Douglas Aircraft Corp., *The Reconnaissance Handy Book*, p. 125.

Ronald J. Ondrejka, “Imaging Technologies, in *Arms Control Verification*, Kosta Tsipis, David W. Hafemeister, and Penny Janeway (eds.), p. 67.

Jeffery T. Richelson, ‘ ‘Implications for Nations Without Space-Based Intelligence-Collection Capabilities,’ (in *Civilian Observation Satellites and International Security*, Peter Zimmerman et al. (eds.)), p. 60.

Ronald A. Scribner et al., *The Verification Challenge: Problems and Promise of Strategic Nuclear Arms Control Verification*, p. 32.

U. S. Congress, Office of Technology Assessment, *Verification Technologies: Cooperative Aerial Surveillance in International Agreements*, OTA-ISC-480, (Washington, DC: U.S. Government Printing Office, July 1991), p. 38.

United States Department of Defense, Headquarters, Department of the Army, STP 34-% D1-SM *Soldier’s Manual Skill Level IMOS 96D Imagery Analyst*, pp. 2-146 to 2-150.

<sup>20</sup> Itek C’I Systems Bulletin IL-2, “IIRS Image Interpretability Rating Scale” (Lexington, MA: Litton Itek Optical Systems, 1984).

indicator of the nature of the facility they surround,<sup>21-22</sup> can be detected by the way they channel foot traffic (and the paths it creates),<sup>23</sup> and by its effect on vegetation,<sup>24</sup> while dummy installations are given away by the absence of foot traffic in their vicinities<sup>25</sup> or the lack of snowmelt on their roofs.<sup>26</sup> In a most remarkable instance of detecting the non-resolvable, J. Skorve found a set of seven Soviet submarine-communications antennas in an 80-meter Landsat picture.<sup>27</sup> Although the antennas themselves cannot be seen, the snowflake pattern<sup>28</sup> created by their bases, their stays, and their stays' bases is some 1,700 meters across. Skorve apparently deduced the function of the antennas from their large size, which bespeaks a long wavelength most suitable for communication with submarines. He indicates that weather conditions prevented a cued follow-up shot with the higher-resolution SPOT. Working with even less raw material, Peter Zimmerman analyzed a SPOT picture of the Soviet Northern Fleet headquarters at Severomorsk, concluding that:

... there are no buildings or rocky terrain around the base, which suggests that caverns have been blasted out of the cliffside.<sup>29</sup>

Photo interpreters are, however, only human, and their logic can at times be faulty. For example, analysts noted that a certain building in Iraq lacked the multiple surrounding fences associated with high-technology

military work. However, it was later discovered that the building lay inside a huge military facility, whose security fences apparently lay entirely outside the boundaries of the overhead picture.<sup>30</sup>

Moreover, targets of sufficient contrast can be detected even if they are too small to be resolved. (We are familiar with this effect because of the operation of our own eyes, which can detect distant stars without resolving them.) Again citing the example of a ship, heat from machinery or absorbed sunlight could make the ship such a bright thermal infrared source, or reflected sunlight could make it such a bright visible, near infrared, or medium infrared source—in contrast to the surrounding sea—that it would light up a whole pixel<sup>31</sup> despite occupying far less space than is imaged by that pixel. Alternatively, concave corners in the ship's superstructure could strongly reflect energy straight back to a radar satellite (such as the now-defunct AlmaZ-1, or ERS-1), again lighting up a point on the image and showing that something other than the ocean was there, even though it could not be resolved.

The whole resolution concept is also confounded by targets that exceed the system's resolution in one dimension while falling short in another. A railroad, for example, is narrower than 30 meters but far longer—railroads can and do occasionally appear in

<sup>21</sup> *Soldier's Manual Skill Level I, Imagery Analyst*, p. 2-439.

<sup>22</sup> “The Space Media Network analysts who published a story about the Soviet electro-optical facility atop Mt. Sanglok in Tajikistan felt confident that they had seen double fencing on that site. Such indications of security call attention to an industrial site that might otherwise have been overlooked. (Peter Zimmerman, “The Use of ‘Open Market Observation Satellites for the Monitoring of Multilateral Arms Control Accords,” p. 51.)

<sup>23</sup> *Soldier's Manual Skill Level i*, op. cit., footnote 21, p. 2-367.

<sup>24</sup> Ibid., p. 2-457.

<sup>25</sup> Ibid., p. 2-360.

<sup>26</sup> Dino A. Brugioni, “The Serendipity Effect of Aerial Reconnaissance, *Interdisciplinary Science Reviews*, vol. 14, No. 1, 1989, p. 16. Brugioni also points out that snowplowing habits can indicate facilities' functions: headquarters buildings typically receive the most prompt service.

<sup>27</sup> Johnny Skorve, *The Kola Image Atlas*, Oslo, The Norwegian Atlantic Committee, 1991.

<sup>28</sup> The sixfold symmetry arises because six antennas surround the seventh in a hexagon.

<sup>29</sup> Peter Zimmerman, “A New Resource for Arms Control,” *New Scientist*, Sept. 23, 1989, p. 39.

<sup>30</sup> Jay C. Davis and David A. Kay, “Iraq's Secret Nuclear Weapons Program,” *Physics Today*, July 1992, p. 24.

<sup>31</sup> A “p~el,” short for “picture element,” is a single one of the many dots, of differing color and/or brightness, that combine to form a picture. Computer graphics use true pixels, while newspaper and magazine pictures use an offset image printing process whose dots can be seen with a magnifying glass, Broadcast TV forms images that are discrete, like computer images, in the scan-to-scan dimension and diffuse, like emulsion film images, in the along-the-scan one.

Landsat images, because a pattern made up of non-resolvable elements can be discerned.<sup>32</sup>

Thus, resolution requirements are hard to specify. The following sections assess the military utility of particular satellites not just in terms of the resolutions needed for particular tasks, but in terms of the satellites' proven overall abilities to see targets of interest in MC&G, meteorology, broad area search, Indications and Warning, battlefield intelligence, and arms control monitoring. Considerable overlap exists in these target categories. For example, a large clandestine missile factory or radar would be a broad area search target and also an arms-control monitoring target.

**Scene Size**—Just as users will always hanker after finer resolution, they will always want larger scene sizes, everything else being equal. However, larger scenes come at a price—in dollars, resolution, or both—and therefore are subject to some limits.

**Spectrum**—“Panchromatic” sensors make images that a lay person would term a black-and-white photograph, using visible light.

“Spectral coverage” refers to the satellite’s ability to detect light, and thus form images, in different parts of the spectrum, such as the visible band or infrared. These can all be combined into a “panchromatic” (black-and-white) picture, or separated. “Multispectral” sensors take, or construct, what the lay person would call color pictures. Normally the colors seen in the color pictures are not the colors of the original scene, but are instead a “fauvist” color set chosen so as to make the information contained in the picture as apparent as possible to the human eye. One obvious reason for making such a color substitution is that the wavelengths originally collected by the sensor may not be visible to the human eye. For example, the infrared portion of the spectrum (with wavelengths too long to be seen by the human eye) contains data useful in a variety of circumstances such as nighttime. Therefore a “color composite” image is used, in which the various parts of the spectrum sampled by the sensor are represented by colors visible to the human eye. In the

common case of a combination using the near infrared band, such as a Landsat 4,3,2 TM band combination, the term “false color” is often used to describe this form of enhanced presentation.

“Spectral resolution” refers to the satellite’s ability to subdivide the covered portion of the spectrum into smaller segments, in effect discerning different colors in the scene. While multispectral sensors of the Landsat class collect images using a handful of wavelength bands, recent advances in detector technology and computational power have made it possible to build sensors that have hundreds of very narrow spectral bands. These “hyperspectral” imaging systems, still experimental in nature, have the potential to discern much additional information in the scene, contributing to the detection of camouflaged or concealed targets, ocean bottom features, small-plot crop plantings of interest to drug interdiction efforts, detailed structures in clouds, and other highly detailed image features of military interest. Whereas panchromatic sensors combine all the light they receive into a single image and multispectral sensors sample light in several non-adjacent color bands, hyperspectral sensors sort incoming light into a hundred or more mutually exclusive and collectively exhaustive “bins. The detailed spectral information thus captured allows for detailed examination of the scene, especially with regard to identifying particular materials in the scene by their unique spectral “fingerprints.”<sup>33</sup>

Synthetic Aperture Radars, such as those aboard the now-defunct Almaz-1, JERS - 1, and ERS - 1, operate at even longer wavelengths, the microwave portion of the electromagnetic spectrum. Their final products have the appearance of black-and-white photographs, but they can be colorized, for example to display soil characteristics of particular interest.

**Stereoscope**—Three-dimensional or “stereo” images are useful in a wide variety of tasks, and essential in map-making and the creation of scenery in flight simulators. A stereo satellite image combines images taken at slightly different locations in the fashion familiar from childhood’s various “3-D Viewer” toys

<sup>32</sup> An even more complicated case is that of minefield. The minefield’s extent can exceed the sensor’s resolution in both directions, with each mine being nonresolvably small. In some cases, the trained eye can perceive the presence of the field, based on the pattern of nonresolved specks.

<sup>33</sup> Rosenberg, *op. cit.*, footnote 10, and an Aug. 27, 1992, briefing at the Naval Research Laboratory, Washington, DC, on their HYDICE (Hyperspectral Digital Imaging and Correlation Experiment) project.

and, indeed, from human depth perception itself. In some applications, a photo interpreter sees and benefits from this illusion personally;<sup>34</sup> in others, computers manipulate the data to produce a contour map, with no actual 3-D viewing having taken place. The value of stereoscopic coverage is so great as to elicit a rare instance of sardonic wit from the U.S. Army in its *Soldier's Manual, Skill Level I Imagery Analyst*: "You will appreciate the advantages of stereoscope more each time you interpret photography that doesn't have sufficient overlap to permit stereo viewing."<sup>35</sup> For best results with human viewing, the separation between the points where the picture was snapped should be about a tenth of the distance to the target.<sup>36</sup>

Photo reconnaissance aircraft produce the stereo pairs by taking photographs in rapid succession during their pass over the target. Civilian satellites currently lack this ability, and can make stereo pairs only by carefully planned shots on separate orbits. JERS-1 planning included the ability to make along-track stereo pairs.<sup>37</sup>

**Metric—Accurate** photogrammetric measurement of the objects seen in the image requires an accurate account of the distance and viewing angle from the sensor to the target. If, in addition, accurate absolute location of the objects with respect to a larger coordinate system (such as global latitude, longitude, and altitude) is desired, an accurate account of the absolute location of the sensor is needed. Such location is now best obtained from the Global Positioning System (GPS), whose unencrypted signals normally allow three-dimensional location to within 80 meters or better and time-domain location within a hundred-millionth of a second and whose encrypted signals provide even freer location and time accuracy. The analogous Russian GLONASS system provides comparable accuracy but poor coverage. Through repeated measurements, the accuracy of either system can be increased. Access to the "precise-code" GPS output, which is normally encrypted, could allow a satellite to

locate itself to within 10-meter accuracy or better. Special processing software can also improve metric accuracy. For example, routine decisionmaking data processing can locate SPOT data to within half a pixel.<sup>38</sup>

Considerable accuracy is possible even without such systems. France's SPOT, for example, can locate its pictures to within one kilometer purely through the use of its own orbit data.<sup>39</sup>

**Timeliness—There are** actually two aspects of timeliness, both desirable. First, the rapidity with which an order is filled, measured in terms of the length of time between the request and the collection of the imagery. Second, the freshness of the imagery, measured in terms of the length of time between the moment that the image is collected and the moment it is delivered to the customer. These two types of timeliness are not strongly related, except insofar as most customers will want them both.

The former depends in part on the "revisit time" of the satellite (how long it takes between successive passes over the same spot) and the degree to which it can aim its camera obliquely, obviating the need for an exact pass over the target. These combine to create an average delay between successive opportunities to image the target. The actual delay—which one might term the "visit time"—experienced by the customer will vary according to how lucky he or she is: a lucky customer will request a picture right before an opportunity to schedule it arises, while an unlucky one will request a picture just after a good time to take it has passed, resulting in a delay. Such a customer might want to shop around for a different satellite's services. Customers seeking visible-light views of regions frequently covered by clouds will also find themselves subject to collection delays caused by weather. Revisit times can be considered two ways: the revisit time of a particular satellite, or that afforded by a satellite system, in which a pair of satellites can halve the revisit time. The second column of the table below reflects

---

<sup>34</sup> With, perhaps, an artificially exaggerated depth dimension so as to aid in the interpretation task.

<sup>35</sup> *Soldier's Manual, Skill Level I*, op. cit., footnote 21, p. 2-281.

<sup>36</sup> Donald Light, U.S.G.S National Aerial Photography Program

<sup>37</sup> Zimmerman, op. cit., footnote 22, p. 21.

<sup>38</sup> William Kennedy, Hughes STX Corp., personal communication, July 8, 1992.

<sup>39</sup> William Leith and David W. Simpson, "Monitoring Underground Nuclear Tests," in Peter Zimmerman, *Civilian Observation Satellites and International Security* (New York, NY: St. Martin's, 1990), p. 116.



**Table C-3—Timeliness of Selected Civilian Sensing Systems**

Satellite	Revisit time (days)	"Freshness" (days)
JERS-1	44 <sup>a</sup>	
SPOT	1-4 <sup>b</sup>	variable <sup>c</sup>
Landsat <sup>d</sup>	8-16	1
Almaz	4-6 <sup>e</sup>	

<sup>a</sup> Peter D. Zimmerman, *The Use of "Open Market" Observation Satellites for the Monitoring of Multilateral Arms Control Accords*, prepared for the United Nations Department of Disarmament Affairs, p. 21.

<sup>b</sup> Ronald J. Ondrejka, "Imaging Technologies," *Arms Control Verification*, Kosta Tsipis, David W. Hafemeister, and Penny Janeway (eds.), p. 79. Allen V. Banner, *Overhead Imaging for Verification and Peacekeeping Studies: Three Studies*, prepared for the Arms Control and Disarmament Division (Ottawa, Ontario, Canada: External Affairs and International Trade Canada, 1991), p. 18. Banner specifies that at 45 degrees from the equator, "up to 12 images can be acquired [at the same site] during one 26-day orbital cycle with time intervals from 1 to 4 days between successive images," p. 4.

<sup>c</sup> Banner says "Space Media Network [ . . . ] has made special arrangements to get SPOT imagery [to the media] within a few days for fast-breaking stories. However, this kind of delivery cannot be routinely provided and is very expensive. The delivery time for civilian imagery is usually several weeks or more, even for imagery that has already been acquired and archived." (Ibid., Banner, p. 21.) It is said that the U.S. military obtained pictures in about 48 hours during the Persian Gulf War.

<sup>d</sup> D. Brian Gordon, Chairman, Tactical and Military Multispectral Requirements Working Group, Defense Intelligence Agency, testimony of hearings before the House Committee on Science, Space and Technology and the Permanent Select Committee on Intelligence, 102d Cong., 1st Sess., June 26, 1991. Scientific, Military, and Civilian Applications of the Landsat Program, p. 29. Overlap of coverage in northerly regions can allow more than one photo opportunity in the 16-day cycle. For example, targets in the Kola peninsula can be seen by three different passes each 16 days (Johnny Skorve, *The Kola Image Atlas*, Oslo, the Norwegian Atlantic Committee, 1991.)

<sup>e</sup> William Kennedy, Hughes STX Corp., personal communication, July 8, 1992.

SOURCE: Office of Technology Assessment, 1993.

this distinction. Also counted as part of the "visit time" is the delay entailed in processing the customer's order on the ground. This delay—often best measured in weeks in business-as-usual commercial operation—is far beyond acceptable limits for many military uses.

The second type of timeliness, which one might term "freshness," depends upon the way pictures get from the satellite to the customer. Normally, process-

ing on the ground—needed to turn a signal from the spacecraft into a usable image—accounts for much of this delay. In the case of Resurs-F, however, additional delay results from the use of a film-return—as opposed to TV-like-transmission of the picture from the satellite. Film-return systems return a capsule of photographic film to the ground for processing. A lucky customer will request a picture just before the roll of film is used up. This aspect of timeliness is a major difference between the two high-resolution competitors, SPOT (table C-3) and Resurs-F: SPOT uses a digital video downlink while Resurs-F uses a physical film-return system (see app. D).

**Throughput—Image** vendors can only sell pictures as fast as they can take them. At some level of demand, perhaps reachable by even a single customer during period of peak use such as a war, further pictures cannot be purchased at all for a while, and additional requests will have to go unfilled.

**Cost**—However important the mission, cost is an important consideration. Civilian satellites are no exception. Whether a cost is deemed "high" or "low" depends upon how it compares to the costs of alternative means of accomplishing the mission and to the cost of allowing the mission to remain unperformed (table C-4).

Control-space-race handicappers will already have noted that the civilian satellites with the freest resolutions (SPOT, Resurs-F, and the now-defunct Almaz) do not belong to the United States. Therefore, political considerations might vitiate the potential military utility of these satellites in a crisis. In the case of the Gulf War, this effect worked in favor of the United States: the French were on our side, and sold SPOT images only to "well known clients in support of the allied effort."<sup>40</sup> On the other hand, it has been stated that France denied the United States use of SPOT during planning for the 1986 raid on Libya. Even during normal peacetime operation Russia has had a policy of not selling Resurs-F imagery of its own territory, though Almaz images are available. This practice, too, could change in light of Russian needs for foreign exchange.

<sup>40</sup> Stéphane Chenard, "Lessons of the First Space War," *Space Markets*, April 1991, p. 5.

**Table C-4—Costs and Capacities of Selected Civilian Satellites**

Satellite	Scene size (sq. miles)	Cost per scene	Capacity (scenes/day)
Resurs-F (hi) . . . . .	2,500	NA	NA
Resurs-F (lo) . . . . .	10,000	NA	NA
SPOT (pan) . . . . .	1,600+	\$2,450 <sup>a</sup>	NA
SPOT (msi) . . . . .	1,600+	\$2,450 <sup>a</sup>	NA
Almaz . . . . .	625	\$1,400 <sup>a</sup>	100 <sup>b</sup>
Landsat 4,5 TM . . . . .	10,000	\$4,400	NA
Landsat 4,5 MSS . . . . .	10,000	\$1,000	NA
Old Landsat scenes . . . . .	NA	\$1,000	NA

NA—not available.  
<sup>a</sup> William Kennedy, Hughes STX Corp., personal communication, July 8, 1992.  
<sup>b</sup> Craig Covault, "Soviet Radar Satellite Shows Potential to Detect Submarines," *Aviation Week and Space Technology*, Oct. 8, 1990, pp. 22-23. Almaz's image processing facility in Moscow is projected to be able to handle about 100 images per day.

**CIVILIAN SATELLITES' USE IN MILITARY MISSIONS**

**Mapping, Charting, and Geodesy (MC&G)—** Multispectral imagery from civilian satellites provides considerable value-added for military MC&G, and saw considerable use in the Persian Gulf War.

One particular application of mapping is the study of deployment-constraining terrain characteristics in the deployment regions of the Russian land-mobile SS-25 missile. Budget Director Richard Darman cited the Defense Department "absolute need" for multi-spectral images as a reason to turn the Landsat program over to DoD,<sup>41</sup> perhaps to perform this area limitation analysis.

Mapping does not necessarily mean undetailed coverage; some important targets for mapping, such as railroads, are not always visible at the resolutions often associated with maps. Because of its chancy success in picking up these targets, Landsat is the subject of varying performance assessments, ranging from 'Landsat does not show the railroads, sometimes not even the rivers'<sup>42</sup> to:

... since MSI maps are images of the Earth, they show existing roads, trails, airfields, etc. Clear, open areas, which may be suitable for military purposes, also stand out and are easily factored into planning. For example, after the 82nd Airborne Division obtained a Landsat map of Kuwait City, it asked for national imagery to determine if there were traps or obstructions that would prevent an airborne landing. MSI images may be able to show surface or subsurface features down to 30 meters, depending on water clarity. The Navy used MSI data in planning amphibious operations during Operations Desert Shield and Desert Storm.<sup>43</sup>

Certainly some railroads, roads, and rivers are visible in the Landsat pictures (images 1-17) of the Kola peninsula used in J. Skorve's *The Kola Satellite Image Atlas* (footnote 27).

Both SPOT and Landsat data are used in military flight simulators. An important and emerging part of MC&G relates to combat intelligence: the creation of databases for guidance systems. While the creation of scenes used by DSMAC,<sup>44</sup> for example, could well be categorized as combat intelligence, the maps used by the pilot or TERCOM<sup>45</sup> during the approach properly belong to the realm of MC&G. Though Landsat data were not used in preparing TERCOM maps for the

<sup>41</sup> This account drawn from "SAC needs Landsat to hunt mobile missiles," *Military Space*, Dec. 18, 1989 (Arlington, VA: Pasha Publications), p. 3.

<sup>42</sup> Brigadier General Dale E. Stovall, USAF, quoted in "Lessons of the First Space War," *Space Markets*, April 1991, p. 6.

<sup>43</sup> Secretary of Defense Dick Cheney, U. S. Department of Defense, *Conduct of the Persian Gulf War: Final Report to Congress*, p. T-23 1. This reference, while in a section entitled 'Multi-Spectral Imagery: Landsat,' might refer to SPOT MSI as well or instead. SPOT is mentioned in an earlier subsection but without acknowledgment that SPOT images were used in the Persian Gulf War, which they were.

<sup>44</sup> Digital Scene Matching and Correlation. This system accomplishes terminal guidance by relating a TV image of the sighted target area to a stored image, and guiding the missile to that part of the image that has been designated as the target.

<sup>45</sup> Terrain Correlation and Matching. This system uses stored maps of certain patches to be overflown en route to the target. when the missile's inertial guidance system decides that it is over a patch, it activates an altimeter. The altimeter readings are then correlated with the elevations present in the patch to find the missile's ground track. A course correction can then be made, if necessary. Unlike DSMAC, TERCOM looks only at elevations on a one-dimensional ground track, not a two-dimensional landscape.

Tomahawk cruise missile strikes executed in Operation Desert Storm, the ability to make such use of Landsat data is expected in the near future.<sup>46</sup>

Uniquely, the MC&G mission demands extreme consistency in its data. *Change analysis* is useful in almost all military uses of remotely sensed data, but the changes exploited in MC&G imagery maybe so subtle that almost any alterations in the sensor are detrimental, perhaps even fatal, to completion of the mission.<sup>47</sup> Thus, consumers of MC&G data often oppose “upgrades” in the sensors they use, preferring old ones—flaws and all—to new ones whose output will not be strictly comparable to the archived outputs of the old sensors. At the level of precision demanded by MC&G, software cannot compensate for the effects of concern. For example, some MC&G consumers oppose even integer-denominated improvements in resolution, even though one would think that, say, 30-meter resolution could be recovered from 15-meter data simply by averaging blocks of four 15-meter pixels into single 30-meter pixels. Because of possible nonlinearity in the response of the sensors to brightness, however, this approach can fail.

Meteorology—DoD operates meteorological satellite systems, completely devoted to serving the weather-forecasting needs of the military.

Two Defense Meteorological Support Program (DMSP) Block 5D-2 satellites, aided by the National Oceanic and Atmospheric Administration (NOAA) Polar-Orbiting Operational Environmental Satellites (POES) as well as the European Meteosat and Soviet Meteor civilian weather satellites, served the military’s weather forecasting needs in the Gulf War.<sup>48</sup>

Weather and other forces change underwater currents in ways that the Navy must monitor in order to predict sonar propagation paths. This requirement is currently filled by civilian NOAA satellites.<sup>49</sup>

**Broad Area Search—Broad area search for major installations could be accomplished by civilian satellites. Many sources, such as certain editions of the Department of Defense publication *Soviet Military Power* and even a novel by the author Tom Clancy, show photographs of such installations, taken by civilian satellites. (Which is not to say that that is how the Department of Defense or other civilian customers originally became aware of them.) In the cases of the airfields, shipyards, and naval bases, even the untrained eye can readily identify the nature and function of the facilities.**

Interestingly, the coarse resolution of civilian sensors (especially those best suited to broad area search) is less of an impediment, in the case of some high-contrast targets, than one might imagine: detection of *any target* in a supposedly desolate area, even one of sub-pixel size, is a success for the broad area searcher (table C-5). For example, Landsat-4, using its Band 7, detected the “Wrangel Island Anomaly,” a circle 2 miles in diameter on the arctic ice near Wrangel Island. This circle called attention to dots near its center that might otherwise have been overlooked. These turned out to result from tests of a new Soviet submarine’s ability to punch its way through the ice, preparatory to launching a ballistic missile. The circle was made by an observation aircraft circling the test site.<sup>50</sup> In other examples, buildings of the North Korean nuclear plant at Yongbyon show up (albeit as dots) in a Landsat Thematic Mapper<sup>51</sup> picture, and ships off California are visible in the Seasat-A radar image. The use of the Thematic Mapper in this role is intriguing, because it suggests the possibility of deliberately sacrificing resolution so as to obtain improved contrast against a target that is much hotter than the surrounding landscape. In the same vein, one could operate visible-light satellites at night, when

<sup>46</sup> D. Brian Gordon, Chairman, Tactical and Military **Multispectral** Requirements Working Group, Defense **Intelligence** Agency, testimony of hearings before the House Committee on Science, Space and Technology and the Permanent Select Committee on Intelligence, 102d Congress, 1st Sess., June 26, 1991. Scientific, Military, and Civilian Applications of the **Landsat Program**, p. 31. Note that the essence of a **TERCOM** map is its elevation data, available only from stereo imagery.

<sup>47</sup> **Change detection** for **military purposes** may not be as subtle **as that used** by MC&G.

<sup>48</sup> Chenard, *op. cit.*, footnote 40, p. 11.

<sup>49</sup> *Ibid.*

<sup>50</sup> Some sources refer to **this circle as a contrail** whereas others describe it **as an actual trace** on the ice, **created by the slight rainmaking** effect of the contrail. The latter explanation is more plausible in that a contrail would drift away and become diffuse, whereas a melted **circle** in the ice would become more pronounced the longer the airplane loitered.

<sup>51</sup> DOD sources often call this device the ‘**Thematic Imager**,’ perhaps because its output is an **image, not a map**.

Table C-5-Civilian Satellite Images of Area-Search Targets

Installation	Location	Satellite	Source
Cities, towns . . . . .	Kola, former USSR	DMSP	Skorve, p. 48
Ships . . . . .	off California, U.S.	Seasat-A	<i>MX Basing</i>
Large Radar . . . . .	Pechora, former USSR	SPOT	<i>SMP 1987</i> , p. 49
Large Radar . . . . .	Krasnoyarsk, former USSR	SPOT	Zimmerman, p. 41
Airfield . . . . .	Etorufu, former USSR	SPOT	<i>SMP 1987</i> , p. 68
Airfield . . . . .	Schagui, former USSR	Landsat-TM, SPOT	Skorve, pp. 90-93
Naval Base . . . . .	Gremikha, former USSR	Landsat-TM, SPOT	Skorve, pp. 86-90
Submarine C <sup>3</sup> antenna . . . . .	Lovozero, former USSR	Landsat	Skorve, p. 112
Shipyards . . . . .	Severodvinsk, former USSR	SPOT	<i>SMP 1988</i> , p. 35
Shipyards . . . . .	Nicholayev, former USSR	SPOT	<i>SMP 1988</i> , p. 40
Airfield . . . . .	Dolon, former USSR	SPOT	<i>SMP 1988</i> , p. 52
Command Center . . . . .	Sharapovo, former USSR	SPOT	<i>SMP 1988</i> , p. 60
Naval Base . . . . .	Vladivostok, former USSR	SPOT	<i>SMP 1988</i> , p. 84
Airfield . . . . .	Ramenskoye, former USSR	SPOT	<i>SMP 1988</i> , p. 143
Laser Site . . . . .	Dushanbaye, former USSR	Landsat	CK
Uranium Mine . . . . .	Iraq	Resurs-F	<i>JD*</i> p. 879
Nuclear Plant, . . . . .	Yongbyon, North Korea	Landsat-TM	<i>NK</i> , p. 61
SSBN ice-breaking test . . . . .	Wrangel Island, USSR	Landsat-TM	Image 4062123183

\*This article describes the picture and its use, but does not reproduce the picture.

## SOURCE KEY:

CK = *The Cardinal of the Kremlin* (novel). Tom Clancy

JD = *Jane's Defense Weekly*, 4/3/1990

Zimmerman = Peter Zimmerman, "A New Resource for Arms Control," *New Scientist*, Sept. 23, 1989

NK = *North Korea: The Foundations of Military Strength*, Defense Intelligence Agency, Washington, DC, October 1991

Skorve = Johnny Skorve, *The Kola Image Atlas*, Oslo, The Norwegian Atlantic Committee, 1991

SMN = Space Media Network

*SMP 1987* = *Soviet Military Power*, U.S. Department of Defense, Washington, DC, 1987

*SMP 1988* = *Soviet Military Power*, U.S. Department of Defense, Washington, DC, 1988

*MX* = *MX Missile Basing*, United States Congress, Office of Technology Assessment, OTA-ISC-140 (Washington, DC: U.S. Government Printing Office, September 1981)

even the poorest resolution could allow sightings of large, illuminated cities and installations.<sup>52</sup> (Under the Soviet system, there were entire cities whose existence was not publicly revealed or acknowledged.<sup>53</sup> Similar conditions may apply today in other countries.)

Use of coarse-resolution, broad-area (and perhaps economical) sensors for wide-area search with selective follow-up by better and more narrowly focused sensors illustrates the important idea of *cueing*: objects seen with the first system receive special attention from the latter.<sup>54</sup> In many cases, what one might term

"retrocueing" can also occur: once the target is discovered, earlier imagery can be re-examined and the target found in it as well.<sup>55</sup> J. Skorve recounts his successful implementation of both of these strategies using only civilian systems:

It was by scrutinizing a Landsat-TM image from 1985 that the large Schagui airbase in southwestern Kola [in the Russian Federation, formerly the U.S.S.R.] was discovered. The revelation of the existence of Schagui was a real surprise since there were no indications of it in available open sources. First it

<sup>52</sup> Skorve, *op. cit.*, footnote 27, shows an example of this kind of image, made by a Defense Meteorological Program satellite (p. 48).

<sup>53</sup> "In Russia, Secret Labs Struggle to Survive," *New York Times*, Jan. 14, 1992, p. C1.

<sup>54</sup> For more on cueing, see OTA's *Verification Technologies*, *op. cit.*, footnote 19.

<sup>55</sup> Professor R. V. Jones, retrocued by some signals intelligence, found a German V-2 rocket that had previously gone unnoticed in pictures of a V-1 test site in occupied Poland. His highly instructive account appears in his book *Most Secret War* (London, Hamish Hamilton, 1978), pp. 549-551, and is excerpted in OTA's *Verification Technologies*, *op. cit.*, footnote 19, pp. 97-98.

looked as though the airbase was still under construction at the time of imaging in 1985. However, later it was possible to reveal the time-sequence of the development of the Schagui airbase. A complete listing of the Landsat images of the area shows that there was coverage in 1972, 1974 and 1978. Even though the [Landsat] MSS pictures . . . are rather rough, it was possible to show that in the summer of 1972, the airfield was only 25-30 per cent of its present size. The rate of progress could be determined when the 1974 picture became available. It showed that Schagui by then had grown to its present size. . . . Even the Landsat TM image of 1985 was insufficiently detailed to show the most interesting features of the base. It was therefore a major advance when [my group] could requisition a SPOT-P image taken during the 1988 summer season.<sup>56</sup>

Skorve similarly describes his 1985 discovery of the Gremikha naval base in a 1985 SPOT picture, which retroced him to earlier Landsat pictures.<sup>57</sup> The base also appears in the 1978 nighttime DMSP picture presented by Skorve.<sup>58</sup> Retrocuing was also used by U.S. Air Force mission planners in their Scud-hunting efforts during the Persian Gulf Conflict. When a launch was detected, planners would examine pre-existing SPOT pictures of the launch area, looking for likely launcher sites.<sup>59</sup>

Submerged submarines, an important target of broad area search at sea<sup>60</sup>, could conceivably be seen by civilian satellites equipped with Synthetic Aperture Radar. Though the radar waves themselves can penetrate seawater only a little, their presentation of

disturbances on the surface, potentially including submarine wakes, would allow them to detect submarines indirectly.<sup>61</sup> Diverse alternate traces of submarines' passage, such as changes in the water's temperature or even its plankton population, have received intermittent attention over the years.<sup>62</sup> Conceivably some such phenomenon could someday be detected by a civilian satellite. Surfaced submarines would be almost as readily detectable as ships of the same size.

The principal drawback of civilian satellite sensing systems (and, indeed of most systems!) for broad area search is the large number of pictures needed to complete the search. This large number, in turn, translates into time and money.

For example, the former Soviet Union covered about 10 million square miles. A complete search of that territory by Landsat would require about 1,000 pictures, obtained at a cost of \$1 million over many picture months.<sup>63</sup> The subsequent analysis of the Pictures would add more time and cost to the project. SPOT pictures are less expensive per image, but cover less area (albeit at a higher resolution). Use of SPOT pictures would more than double the price: it takes nine SPOT scenes to cover a single Landsat scene.

These daunting figures suggest that true broad area search might not be done very often. More likely, a focused search, based on *prior information* such as the locations of cities, rivers, and coastlines, would be performed. Even so, a Landsat survey of the over 4,500 airfields in the former Soviet Union would, with one

---

<sup>56</sup> Skorve, *op. cit.*, footnote 27, p. 90.

<sup>57</sup> *Ibid.*, p. 86.

<sup>58</sup> *Ibid.*, p. 48.

<sup>59</sup> Craig Covault, 'USAF Urges Great Use of SPOT Based on Gulf War Experience,' *Aviation Week and Space Technology*, July 13, 1992, p. 65.

<sup>60</sup> The modern defense literature contains numerous descriptions of the dramatic change that would come about if 'the oceans were made transparent.' In most cases, the authors have broad area search, not support of combat operations, in mind—they are concerned that ballistic-missile launching nuclear submarines (SSBNs), whose deterrent mission rests on the other side's ignorance of their whereabouts, would become locatable.

<sup>61</sup> Craig Covault, 'Soviet Radar Satellite Shows Potential to Detect Submarines,' *Aviation Week and Space Technology*, Oct. 8, 1990, pp. 22-23.

<sup>62</sup> See Thomas Stefanick, *Strategic Antisubmarine Warfare and Naval Strategy*, (Lexington, MA: Lexington Books, 1987), especially app. 3.

<sup>63</sup> While Landsat would require only weeks to orbit over each scene, it could take months or even years to collect a complete set of clear-weather daylight pictures. Recall Skorve's experience in imaging the Kola Peninsula.

picture each, cost \$18 million.<sup>64</sup> In this case, use of SPOT would be more economical, because an airfield would fit inside a single scene, negating SPOT's disadvantage of having a smaller scene size: the SPOT version of this search would cost only \$4.5 million.

Searches at sea highlight another problem as well. Not only would an Almaz search of the 400,000-square-mile Sea of Japan (an antisubmarine warfare arena of modest size) have required 640 25x25-km scenes at a total pre-analysis cost of about a million dollars, but it would have taken at least a week to complete<sup>65</sup>—too long to be of use in many antisubmarine warfare scenarios.

A new broad-area search mission has arisen with increasing military involvement in countering the narcotics trade: searching for fields of illegal drugs. According to a United Nations report,

... it would be feasible to develop a global system for locating cultivation of illicit narcotic crops by spaceborne remote sensing devices but that preliminary activity would need to include inspection on the ground at selected test sites to verify the accuracy of information interpreted from satellite photography.<sup>66</sup>

Presently, there is great interest in detecting coca (from which cocaine is derived) planted in South America. Created as a land-use sensor, Landsat would seem ideal for this mission. However, coca turns out to be a difficult crop to monitor. MSS and TM differentiate between vegetation and other features by detecting key substances such as chlorophyll, other pigments, color in general, water content, and even leaf structure.<sup>67</sup> It turns out that the contrast from the minor chlorophyll differences among coca and other local plants such as citrus fruits is small.

Not only is coca's multispectral signature similar to that of other plants in the area, but the agricultural

practices of the coca growers can stymie detection: they interplant coca with other crops, and even grow it in patches covered by a tree canopy. Coca tends to be produced in small plots, commonly a half a hectare to two hectares—so small-sized plots would be too small to dominate a pixel,<sup>68</sup> increasing the probability that surrounding features will overshadow evidence of coca. Also, other interfering features (e.g., smoke, clouds) can interfere with satellite detection. Large marijuana fields, however, generally create an easier Landsat target.

**Indications and Warning—The indications and warning mission (I&W) is very demanding, and policy makers would certainly like to be able to spread it among as many systems as possible.** Table C-6 lists a variety of targets similar to those that might be routinely imaged in the performance of the I&W mission.

While aircraft are visible in Banner's SPOT pictures of Kabul airport, they become much more apparent when one panchromatic image of the airport is overlaid on another, with false color added to highlight differences. Then the moved aircraft—which appear only in one image or the other and are hence brightly colored—become quite obvious not only through their color and shape but through their placement on ramps and runways where any large movable object would be presumed to be an aircraft.

Banner's SPOT-aided discovery that trucks had left a military encampment near Kabul deserves special note for two reasons. First, Banner's knowledge that the site was a military camp, and that it housed the Soviet 108th Motorized Rifle Division, was not gained via satellite imagery: it was *collateral information*, openly available, that aided him in his photointerpretation. Second, the size of an individual vehicle

<sup>64</sup> Assuming that no two airfields are close enough to fit into the same picture. In fact, near cities two or three airfields might exist in the same Landsat scene. However, this effect is not strong enough to alter the conclusions of this calculation. Skorve's 17-picture Landsat Kola atlas shows an average of only slightly more than one airbase per picture (not counting duplicate views of the same base in overlapping pictures) even though Kola is a very militarized region and even though some pictures show as many as four or five bases.

<sup>65</sup> Almaz facts from *Aviation Week and Space Technology*, Oct. 8, 1990; area of the Sea of Japan from 1990 World Almanac. Almaz's image processing facility in Moscow is projected to be able to handle about 100 images per day.

<sup>66</sup> UN International Narcotics Control Board Report for 1990, 1/91.

<sup>67</sup> Kennedy, op. cit., footnote 38.

<sup>68</sup> A hectare is 10,000 square meters, or about 2.5 acres. An 80 x 80 meter pixel is thus 0.64 hectares in area, and its boundaries would not necessarily be aligned with those of the planted plot. Even adjacent small coca plantings may not add up to a discernible target because they are owned by different growers, who cultivate them in different ways. Thus the signature of an unharvested field may be diluted by that of an adjacent harvested field.

Table C-6-Civilian Satellite Images of I&W-Type Targets

Target	Location	Satellite	Source
SSBN base w/SSBN . . . . .	Zapadnaya Litsa, former USSR	SPOT	Skorve, p. 99
Naval base w/ships . . . . .	Severomorsk, former USSR	SPOT	Zimmerman, p. 39
Naval base w/carrier . . . . .	Severomorsk, former USSR	SPOT	Skorve, p. 67
Airbase w/aircraft . . . . .	Kabul, Afghanistan	SPOT	Banner, p. 17
Encampment w/vehicles . . . . .	Kabul, Afghanistan	SPOT	Banner, p. 18
Pentagon parking lots . . . . .	Arlington, VA	SPOT	suggested by P. Zimmerman

SOURCE KEY:

Banner = Allen V. Banner, *Overhead Imaging for Verification and Peacekeeping Studies: Three Studies*, prepared for the Arms Control and Disarmament Division (Ottawa, Ontario, Canada: External Affairs and International Trade Canada, 1991), pp. 7-8.

Skorve = Johnny Skorve, *The Kola Image Atlas*, Oslo, the Norwegian Atlantic Committee, 1991.

Zimmerman = Peter Zimmerman, "A New Resource for Arms Control," *New Scientist*, Sept. 23, 1989.

would make one think that a system with SPOT’s resolution could not see vehicles, but Banner detected their departure by the fact that they had been parked together, aided by change analysis. In his own words:

Using SPOT imagery, with its spatial resolution of 10 m or more, all but the largest military vehicles will be smaller than even a single image pixel. Nevertheless, imagery of this quality might provide some limited evidence of large-scale migration of vehicles from an area. . . . The red areas in the change image [an “after” picture subtracted from a “before” picture-OTA] are indicative of dark-toned features that existed in 1987 but not in 1988. The thin lines . . . and smaller features . . . might be vehicles parked in rows and next to a building. The thicker red areas . . . might be vehicles parked several rows deep. Although the spatial resolution of SPOT imagery is clearly insufficient to detect individual vehicles, it might be able to detect changes in orderly rows of vehicles. At the same time, other possible explanations for the changes are apparent in the imagery. For example, it could be tents or packing crates that have been moved.<sup>69</sup>

For many purposes, the sudden departure of large objects from a military base would be of great interest even if one could not establish whether the objects were crates, trucks, or tents. While Banner’s interest is the verification of troop withdrawals amid the outbreak of peace, the same technology and logic could be

applied to see troop arrivals, or the departure of troops from their customary bases. This last item takes on particular salience in the context of the indications and warning mission. Perception of these aircraft and vehicles at such low resolution would be vulnerable to deceptions in which dummy equipment is substituted for the real thing.<sup>70</sup>

Sensors capable of piercing clouds or darkness, such as thermal infrared and radar sensors, could provide the timely coverage that is particularly vital in the I&W task. This consideration is hardly second-order; the Kola peninsula, for example, widely cited during the Cold War in such terms as “the largest concentration of military installations and hardware anywhere in the world”<sup>71</sup> and therefore rating intensive I&W coverage, experiences overcast conditions 80 to 90 percent of the time. Four-fifths of the peninsula lies above the Arctic Circle and thus experiences round-the-clock darkness part of the year. With “prevailing bad luck” some targets in the peninsula went through a whole year without presenting themselves to be photographed by J. Skorve’s civilian satellite survey.<sup>72</sup>

**Combat Intelligence**-Unlike the shipyards, airfields, and other targets of broad area search, the targets of combat intelligence occupy sharply delimited areas-the battlefield and its environs. Thus when Air Force planners looking at combined SPOT and Landsat

<sup>69</sup> Allen V. Banner, *Overhead Imaging for Verification and Peacekeeping: Three Studies*, prepared for the Arms Control and Disarmament Division (Ottawa, Ontario, Canada: External Affairs and International Trade Canada, 1991), pp. 20-21.

<sup>70</sup> R. V. Jones, *Reflections on Intelligence* (London, England: William Heinemann Ltd, 1989), p. 123. In their Second World War battle at El Alamein, the British deployed dummy artillery and fooled the Germans, who eventually caught on only to be fooled again when real artillery replaced the dummies!

<sup>71</sup> Johan Jorgen Hoist, in his preface to Skorve’s *The Kola Satellite Image Atlas*, p. 6.

<sup>72</sup> Skorve, *op. cit.*, footnote 27, pp. 54-55.

Table C-7—Civilian Satellite Images of Combat Intelligence-Type Targets

Installation	Location	Satellite	Source
Ships . . . . .	off California, U.S.	Seasat-A	<i>MX Basing</i>
Damaged reactor . . . . .	Chernobyl, former USSR	SPOT, Landsat	<i>SMP 1987</i> , p. 115
Bombed bridges . . . . .	Baghdad	SPOT	<i>ES</i> , p. 13
Naval base . . . . .	Vladivostok, former USSR	SPOT	<i>SMP 1988</i> , p. 84

## SOURCE KEY:

*SMP 1987* = *Soviet Military Power*, U.S. Department of Defense, Washington, DC, 1987.

*SMP 1988* = *Soviet Military Power*, U.S. Department of Defense, Washington, DC, 1988.

*MX* = *MX Missile Basing*, United States Congress, Office of Technology Assessment, OTA-ISC-140 (Washington, DC: U.S. Government Printing Office, September 1981).

*ES* = *Electronic Spies*, by the editors of Time-Life Books (Alexandria, VA: Time-Life Books, 1991).

pictures of a fertilizer plant in Al Qaim (Iraq) saw antiaircraft installations around it and deduced that they should bomb it,<sup>73</sup> they were performing combat intelligence, not broad area search. The antiaircraft example also illustrates how the utility of non-resolvable or barely resolvable images can be enhanced by combining them with better images.<sup>74</sup> For example, the *SMP 1987* picture of Chernobyl combines SPOT panchromatic imagery and Landsat thermal imagery, creating a useful view of the overheated reactor. Remarkably, many U.S. military units, even low-level commands, have the ability to combine imagery in this way.<sup>75</sup>

Though, as mentioned above, Landsat often cannot see roads, DIA has stated that ‘during preparations for the ground war during Operation Desert Storm, 30-meter Landsat could have revealed ground scars and track activity indicating the thrust into Iraq west of Kuwait.’<sup>76</sup> It has been claimed that both sides in the Iran-Iraq war purchased SPOT images as a means of gaining combat intelligence,<sup>77</sup> so such concerns *are* hardly misplaced. In the case of Desert Storm, however, U.S. and French vendors did not sell to Iraq after hostilities began.<sup>78</sup>

Use of even coarser resolution images may be possible. A Singapore-based civilian aviation journal has reported that:

Pictures from the domestically developed IRA-IA B remote sensing, and INSAT-D weather satellites are being used for photo-processing and weapon targeting under a high priority defence project that is ushering India into the era of satellite reconnaissance and communication. When fully commissioned, this system will increase India’s capability for targeting its cruise and ballistic missiles for counter-base and counter-force operations, as well as giving the country’s armed services a near real-time theater reconnaissance and battle-damage assessment capability.

In modern warfare, **part** of combat intelligence is the preparation of fighting men for particular missions. The Air Force’s successful attempt to staunch the massive Kuwaiti oil leak perpetrated by Saddam Hussein near the end of the Gulf War was rehearsed in simulators using SPOT data.<sup>79</sup> Formulation of databases to drive simulations used for training and mission planning represents an emergent use of remotely sensed civilian data. DIA has shown mem-

<sup>73</sup> Chenard, *op. cit.*, footnote 40, p. 4. This is probably the same well-protected ‘fertilizer plant’ mentioned by Gordon on p. 30 of the June 26, 1992 testimony. For more on the fascinating art of **photointerpretation**, see OTA’s *Verification Technologies: Cooperative Aerial Surveillance in International Agreements*.

<sup>74</sup> In principle, an image’s resolution could be improved by combining it with another image of equal quality, as long as the pixel boundaries fell in different places on the two images (as would be almost guaranteed to happen.)

<sup>75</sup> D. Brian Gordon, Chairman, Tactical and Military Multispectral Requirements Working Group, Defense Intelligence Agency, testimony of hearings before the House Committee on Science, Space and Technology and the Permanent Select Committee on Intelligence, 102d Congress, 1st session, June 26, 1991. Scientific, Military, and Civilian Applications of the Landsat Program, p. 29.

<sup>76</sup> *Ibid.*, p. 56.

<sup>77</sup> Chenard, *op. cit.*, footnote 48, p. 5.

<sup>78</sup> Gordon, *op. cit.*, footnote 75, written response to questions inserted for the record, p. 57.

<sup>79</sup> *Ibid.*, p. 31.



bers of Congress a few minutes of video tape portraying a simulated pilot's eye view of a flyaround of Kuwait City and the neighboring Faylakah Island. Landsat, SPOT, and Resurs-F images were combined to create this tape.<sup>80</sup> A published example shows how an original SPOT picture of Baghdad can be turned into a pilot's-eye view of the approach to a target, complete with antiaircraft guns and annotations showing the locations of sites to avoid hitting, such as schools and mosques.<sup>81</sup>

An important part of combat intelligence relates to MC&G: the creation of databases for guidance systems. While the creation of map patches used by TERCOM, for example, could well be categorized as MC&G, the scenes used by the pilot or DSMAC (Digital Scene Matching and Correlation) properly belong to the realm of combat intelligence.

As mentioned in the description of the nascent Indian capabilities, the combat intelligence mission continues after the attack is made. *Bomb damage assessment* must be performed to see if the target merits another attack. The entry in table C-7 regarding the damaged reactor at Chernobyl represents a possible bomb damage assessment mission, but the reader should be aware that bomb damage assessment is notoriously difficult even with the best of sensors, and that civilian satellites are unlikely to play any appreciable role in bomb damage assessment in the foreseeable future.<sup>82</sup>

In performing the combat intelligence mission during coalition warfare such as that prosecuted by our

side during the war with Iraq, civilian satellites have the advantage that their product can be released to foreigners allied with the United States.<sup>83</sup> It can also be distributed near the front without fear of compromising the capabilities of highly classified systems if combat intelligence documents are captured.

**Arms Control Agreement Monitoring—'Politics,' as Prince Bismarck said, "is the art of the possible."**<sup>84</sup> For this reason, arms control agreements are, to a large degree, crafted so as to be verifiable at the limits of available technology.<sup>85</sup> The SALT arms control agreements<sup>86</sup> dealt with large objects such as submarines and missile silos. President Jimmy Carter said, during the SALT era, that "Photoreconnaissance satellites have become an important stabilizing factor in world affairs in the monitoring of arms control agreements."<sup>87</sup> Increased arms control ambitions and improved verification technology (as well as the newfound acceptability of on-site inspection) now combine to create agreements such as START, in which constraints are applied to the payloads of missiles deployed underground.

Present-day civilian satellites seem hardly capable of verifying even yesterday's arms control agreements. For example, SALT specified that an intercontinental ballistic missile (ICBM) would be deemed to be of a "new type" if its dimensions (or, more accurately, the dimensions of its silo launcher) differed from those of its predecessor by more than 5 Percent.\*\* Such a tolerance---less than 1 meter<sup>89</sup> cannot be measured

<sup>80</sup> Ibid., p. 37.

<sup>81</sup> Covault, *Op. cit.*, footnote 59, pp. 61, 63.

<sup>82</sup> Secretary of Defense Dick Cheney, *Conduct of the Persian Gulf Conflict: An Interim Report to Congress, p. 14-2, and Conduct of the Persian Gulf War: Final Report to Congress*, pp. C-14 to C-16.

<sup>83</sup> Gordon, *op. cit.*, footnote 75, p. 28.

<sup>84</sup> Th. *Oxford Dictionary of Quotations*, 4th edition, Angela Partington (ed.) (Oxford, NY: Oxford University Press, 1992), p. 84.

<sup>85</sup> Ideally, technology would be developed with an eye to making verifiable those agreements that were desirable for other reasons. See U.S. Congress, Office of Technology Assessment, *Verification Technologies: Managing Research and Development for Cooperative Arms Control Monitoring Measures*, OTA-ISC-488 (Washington DC: U.S. Government Printing Office, May 1991).

<sup>86</sup> From today's perspective SALT I includes the signed and ratified ABM Treaty and the Interim Agreement on Offensive Arms. SALT II was signed but never ratified. All continue to figure in today's arms-control compliance debate, even though time spans stated in the Interim Agreement and SALT II have now elapsed. START, signed but not yet ratified, subsumes many of the SALT provisions that have lived on past their official lifetimes.

<sup>87</sup> Speech by President Jimmy Carter, at the Kennedy Space Center, Oct. 1, 1978.

<sup>88</sup> Later, considerable contention would arise over the question of whether this proviso referred to linear dimensions or to volume. In the present context, this important consideration is irrelevant.

<sup>89</sup> Not because 5 percent of the diameter is less than a meter, but because the difference between an allowable 5 percent change and an illegal 6 percent change is less than 1 meter. This important point is made by Zimmerman, *op. cit.*, footnote 22, p. 41.

by today's civilian satellites, though they could see the construction equipment present during silo modification if they looked at the right time.

However, civilian remote sensing satellites are not without utility in arms control verification (table C-8). They can, for example, locate facilities deserving greater attention from other treaty-monitoring systems, including onsite inspection. Jasani's analysis of SS-25 sites in the former Soviet Union brings to light several discrepancies between the site plans submitted by the Soviet side and the actual layouts of the sites. The INF Treaty protocol allows for the revision of data submitted in the data exchanges (Article IX.3), and SPOT-derived indications that such revision was in order could be freely shown to CIS representatives.

## | The View From the Other Side

So far this analysis has been one-sided, addressing only the benefits the U.S. military could derive from civilian remote sensing satellites. In this section we shall turn to the view from the other side—ways in which an adversary could diminish the utility of these satellites to the United States military, and ways in which he could avail himself of their services to the military detriment of the United States.

### CAMOUFLAGE, CONCEALMENT, AND DECEPTION (CC&D)<sup>90</sup>

Sun-Tzu Wu, the ancient Chinese military writer, maintained that deception was the cornerstone of successful military planning. More recently, the erstwhile Soviet military emphasized the role of *maskirovka*, a military art grouping under one tarpaulin the Western notions of camouflage, concealment, and deception.<sup>91</sup> The Soviets' confederated successors and Third-World understudies doubtless attach similar importance to these dissimulative practices.

"Camouflage is the technique of hiding from view that which is physically present,"<sup>92</sup> and includes the mottled paint and nets festooned with fresh-cut branches

familiar to us from war movies and television, and other techniques of making the objects of interest blend in with the ground.

"Concealment" includes other means of avoiding detection. In the case of radar satellites such as Almaz, concealment could be accomplished by jamming—beaming junk radio waves of the correct frequency at the satellite. Such jamming would "appear as dark static interference on imagery and [would] usually cover the entire section of imagery in the area of coverage."<sup>93</sup>

"Deception is the technique of making what is physically present appear to be something different."<sup>94</sup> It includes the use of dummies and decoys. "Dummies are imitations of actual objects or installations, usually composed of dummy weapons, emplacements, vehicles, and equipment. They are designed to simulate real activity and draw fire away from camouflaged or concealed activities. Decoys are lures located in logical military positions but far enough from actual targets to prevent fire directed against them from hitting the real sites,"<sup>95</sup> Interestingly, a decoy or dummy must—for realism's sake—be camouflaged, though not so well as to prevent it from being seen!

Military applications of civilian remote sensing that use the sensors' utmost spatial resolution and rely heavily on the deductive powers of the end user could be deceived by the crudest of CC&D operations: 10-meter resolution could hardly hope to discriminate a decent dummy from the real thing. However, civilian satellites' *spectral* resolution could come to the rescue: painted-on foliage might look realistic in the visible-light portion of the spectrum, but only the fanciest camouflage nets maintain their deception into the near infrared. Thermal infrared provides yet another view, one very difficult to mask. The detection of these, and of CC&D efforts in general, is aided greatly if *comparative covers* (multiple images of the same region) are available: comparison of a current image to an archive picture taken much earlier immediately

<sup>90</sup> See also OTA's *Verification Technologies*, op. cit. footnote 19, especially ch. 3 and app. B.

<sup>91</sup> See, for example, *Camouflage: A Soviet View, Soviet Military Thought*, no. 22, translated and published under the auspices of the U.S. Air Force (Washington, DC: U.S. Government Printing Office, 1989). This volume is comprised of two Soviet books on *maskirovka*.

<sup>92</sup> Soldier's *Manual Skill* Level I, op. cit., footnote 21, p. 2-298.

<sup>93</sup> *Ibid.*, p. 2-484.

<sup>94</sup> *Ibid.*, p. 2-298.

<sup>95</sup> *Ibid.*, p. 2-236.

Table C-8-Civilian Satellite Images of Arms-Control Targets

Installation	Treaty	Satellite	Source
Semipalatinsk Test Site, USSR . . . . .	LTBT	SPO1, Landsat	Zimmerman, plate 2
Kahuta Enrichment Plant, Pakistan . . . . .	NPT*	SPOT 1	Zimmerman, plate 5
Pakistan . . . . .			
Large radar, USSR . . . . .	ABM	SPO1	SMP 1987, p. 49
Large radar, Krasnoyarsk, former USSR . . . . .	ABM	SPOT	Zimmerman, p. 41
Dimona reactor, Israel . . . . .	NPT*	SPOT 1	Zimmerman book, plate 6
RBM base, France . . . . .	NF*	SPOT	Zimmerman, plate 8
Yongbyon nuclear plant, North Korea . . . . .	NPT	Landsat Thematic Mapper	NK, page 61
Uranium Mine, Iraq . . . . .	NPT	Resurs-F	JD 4/3/1990, p 879
SSBN base w/ Typhoon . . . . .	SALT, START	SPOT	Skorve, pp. 98-99
SS-25 Base . . . . .	SALT, INF, START	SPOT	Jasani, pp. 382-383
J.S. Air Force base . . . . .	SALT, START	Resurs-F	ES, page 36

These sightings are not evidence of treaty violations. They do, however, bear on the issue of treaty compliance. For example, the Pechora radar would, if not facing out from the perimeter of the former Soviet Union, be a violation of the ABM Treaty.

\* Indicates that the country imaged is not a signatory of the treaty in question: nevertheless, the target is physically typical of the items that those nations that did sign the treaty pledged to limit.

TREATY KEY:

- ABM = SALT I "Antiballistic Missile Treaty"
- LTBT = Limited Test Ban Treaty
- NPT = [Nuclear] Non-Proliferation Treaty

SOURCE KEY:

- ES = *Electronic Spies*, Time-Life Books, 1991.
- Jasani = "Satellites and Arms Verification" Bhopendra Jasani, *Jane's Intelligence Review*, August 1992, pp. 380-383.
- JD = *Jane's Defence Weekly*.
- NK = *North Korea: The Foundations of Military Strength*, Defense Intelligence Agency, October 1991.
- Skorve = Johnny Skorve, *The Kola Satellite Image Atlas* Oslo, the Norwegian Atlantic Committee, 1991.
- SMP 1987 = *Soviet Military Power*, U.S. Department of Defense, Washington, DC, 1987.
- Zimmerman book = *Civilian Observation Satellites and International Security*, Peter Zimmerman (eds.) et. al.
- Zimmerman article = Peter Zimmerman, "A New Resource for Arms Control," *New Scientist*, Sept. 23, 1989.
- Zimmerman = Peter D. Zimmerman, *The Use of "Open Market" Satellites for the Monitoring of Multilateral Arms Control Accords*, prepared for the United Nations Department of Disarmament Affairs.

focuses attention on those features that are different, alerting the interpreter to the fact that they might be parts of a CC&D operation. The U.S. Army's manual for the beginning image analyst counsels: "Be suspicious of everything in the photograph that does not have an explanation."<sup>96</sup>

**SPYING ON AMERICA**

Under current policies, vendors will sell satellite pictures of the United States to anybody who has the money. While one can imagine various ways in which such information could be used in the realm of economic competition (prediction of crop yields, for example), it is at first difficult to imagine ways in which satellite imagery could further a military effort against the United States. Information about the United States is relatively easy to come by, and few potential

enemies have the ability to reach U.S. territory with anything but a terrorist attack. (Even so, terrorist attacks against the United States to date have occurred at foreign airports, bases, or embassies. Additionally, some of these attacks have required information that could not be obtained by satellite, such as the internal layout and security procedures of airline terminals.)

However, remotely sensed data from civilian imaging satellites could be used in certain ways inimical to the United States.

**Obtaining Accurate Location of Target-In the near future, even a technologically unprepossessing foe may be able to fit primitive cruise missiles (perhaps no more complicated than the German V-1s of 50 years ago) with inexpensive, and yet highly accurate, guidance equipment using the universally accessible Global**

<sup>96</sup> Ibid., p. 2-281, as well as numerous other pages.

Positioning System (GPS).<sup>97</sup> Such accurate guidance engenders a need for accurate knowledge of the target's location, because otherwise the accurate guidance is wasted. A typical target would be a building on a military base. A SPOT or other image with good metric data would allow for accurate GPS-based navigation of the missile to the target.

**Testing CC&D Methods—The practitioner of CC&D, especially that directed against civilian imaging satellites, could test the efficacy of his methods by requesting imagery of test targets, in his own territory, incorporating his CC&D methods. In this way he would be spying not on America's territory, but on her civilian detection capabilities vis-a-vis his denial techniques.**

**Observation of Denied Areas—Despite America's overall character as an open society, there exist many good-sized military reservations to which access is denied. These could be probed through the use of satellite photography.**

### | Market Motives and Military Missions

Technical progress is possible in all facets of remote sensing technology—especially in the four basic parameters, spatial and spectral coverage and resolution—but civilian satellites' designs are based on tradeoffs among these and other desirable characteristics. These tradeoffs are made on the basis of civilian science and commercial demands. Assuming that the design of future systems is not shaped by military requirements recycled into the commercial marketplace, will civilian satellites, through technical progress, become ever-more suited to military missions?

Almost any technological improvement in civilian remote sensing technology will have some military benefit, but the principle defect of civilian satellites for military remote sensing—their untimely responsiveness—is unlikely to be remedied unless the designers of civilian satellites accede explicitly to their military customers' demands. In the civilian world, timeliness measured in days or weeks is perfectly acceptable for most applications: geology and topography aren't going anywhere, and pictures of crops, evanescent

though their subjects may be, can often be scheduled far in advance because planting and harvesting occur on strict schedules.

Interestingly, arms control missions—in which civilian satellites do not now perform conspicuously well because of their limited resolution—may be very well-served by the civilian satellites of the future. Market forces will almost certainly push satellites to finer resolutions, and the arms control mission requires no greater a timeliness than do many civilian missions because arms control verification takes place on a diplomatic, not a military, time scale. However, the high resolutions desired by the arms control customer would have little use for nonmilitary missions and would pressure the satellite's design away from the broad-area coverage desired for the nonmilitary missions.

Might a satellite optimized for military uses be built and launched as a commercial venture? Such a "mercant" is already in the advanced planning stage: a U.S. company has proposed to build, launch, and operate a satellite for a foreign customer, providing data with 1-meter resolution<sup>98</sup> and other such deals have been contemplated.<sup>99</sup> This arrangement is not an export of anything but the data, because the foreign customer would at no time lay hands on the satellite or its controls.

### | Findings

1. Civilian satellites such as Landsat, but most notably SPOT and Resurs-F, have considerable military utility. Imagery from these assets can and has been used to support military operations. Their utility for arms control is limited. Technical progress, especially in spatial and spectral resolution, continues to improve the military utility of successive generations of these satellites.
2. Civilian satellites' use to date for military reconnaissance suggests that post-processing, skilled interpretation, and the use of collateral information can make even fuzzy pictures informative. For this reason, the civilian satellites' in reconnaissance exceeds that which might be expected on the basis of ground resolution—a simplistic, though custom-

~ Kosta Tsipis, *New York Times*, Apr. 1, 1992, p. A25.

<sup>98</sup> "Emirates Want To Buy U.S. Spy Satellite," *Space News*, vol. 3, No. 43 (Nov. 16-22, 1992), p. 1.

<sup>99</sup> William J. Broad, "3 Nations Seek To Buy Spy Satellites, Causing a Policy Rift in U.S.," *New York Times*, Nov. 23, 1992, p. A7.

ary, measure of capability-and the highly conservative rules of thumb normally used to relate it to suitability for particular reconnaissance tasks.

3. However, reconnaissance missions' requirements for timeliness often exceed the current capabilities of civilian satellite systems. Because civilian missions' timeliness requirements are relatively lax compared to military ones, civilian satellite systems will continue to fall short in this regard unless they begin to cater expressly to the military market.
4. Foreign ownership of the most capable civilian remote-imaging satellites brings into play the usual foreign-source considerations: the United States could be denied access to imagery for political reasons, and the assets could well be operated in ways inimical to U.S. interests, and so on. Restoration of U.S. technical dominance in the commercial remote-imaging field could allay these fears.
5. Though the possibility of using Landsat, SPOT, and Resurs-F data to sense enemy forces springs most readily to mind when one speaks of military uses of civilian sensing, the military needs accurate meteorological data as well. These, too, come from civilian satellites as well as from the military's own weather satellites.
6. Mapping—including precise measurement of the geoid itself—is a civilian mission with important military applications. These applications include simulation, training, and the guidance of automated weapons. Mapping to date falls short of what most people might imagine, both in terms of coverage and of precision. A more capable system, perhaps a interferometric SAR, would remedy this shortfall.
7. Many uses, civilian and military, of remotely sensed Earth data require that one be able to mix, match, compare, contrast, combine, add, or subtract data from different sources. While such operations are hampered by the plethora of different formats and media in which the data are collected and stored, this lack of standardization poses no insuperable obstacles—data from such diverse sources as Landsat, SPOT, and even the Russian

Almaz are routinely combined once an initial learning period has passed. Moreover, in recent action by the executive branch, the Secretary of Defense and the Director of Central Intelligence have chartered a new Central Imagery Office.<sup>100</sup> Specifically included in its responsibilities are the areas of imagery formats, standardization, and interoperability.

### | Issues for Congress

1. **Standardization:** Is there need for Federal action to regularize Earth data reporting formats and media? If so, ought action to be taken by the executive or the legislative branch?
2. **Competitiveness:** Civilian satellites such as Landsat, but most notably SPOT and Resurs-F, have considerable military utility. Imagery from these assets can and has been used to support military operations. Is potential loss of this military market, by EOSAT to foreign suppliers a national competitiveness concern?
3. **Threats to Security:** The United States could be denied access to imagery for political *reasons*, and the assets could well be operated in ways inimical to U.S. interests. Putting the shoe on the other foot, other countries could use civilian images of the United States or its foreign military deployments to plan their attacks. Can the U. S., **through its Landsat program, take action to prevent or deter** such operation?
4. **Entanglement:** Foreign belligerents can, and probably have, buy Landsat pictures (or use GPS data) to further their wars against each other. They might even buy them to prepare for a war (or terrorism) against the United States or its allies, fulfilling Lenin's prophecy that the capitalist would sell the rope that would be used to hang him. How should the United States respond to indications that such activity might be in the offing? Could the United States detect that such use of Landsat images was being made?

---

<sup>100</sup> Department of Defense Directive 5105.56, May 6, 1992.

# Appendix D: Non-U.S. Earth Observation Satellite Programs

**M**any countries routinely use satellite remote sensing for land planning, weather forecasting, environmental monitoring, and other purposes. Most of these countries share data with the United States, neighboring countries, and international organizations. This appendix summarizes the remote sensing systems of other countries and organizations.

## EUROPE

Development of remote sensing spacecraft in Europe is under the management of the European Space Agency (ESA), a consortium of 13 member states—Austria, Belgium, Denmark, Germany, France, Ireland, Italy, The Netherlands, Norway, Spain, Sweden, Switzerland, and the United Kingdom. Finland has ESA Associate Member status, and there is an agreement for close cooperation with Canada. Since ESA'S inception in May 1975, it has pursued an Earth observation program.

### Meteosat/MOP

ESA'S Earth observation program was based initially on a series of pre-operational meteorological satellites, called Meteosat.<sup>1</sup> The first—Meteosat 1—was launched in November 1977 and placed in a geostationary orbit, but suffered an onboard imaging failure after two years of service. A second pre-operational Meteosat was launched in June 1981. Yet another of the series, a Meteosat P2 (a refurbished engineering model for the pre-operational series), was deployed in June 1988.

The first spacecraft of the Meteosat Operational Programme (MOP-1) was launched in March 1989 and carried four independent imaging

---

<sup>1</sup>*What's the Forecast? The European Space Meteorology Operational Programme*, European Space Agency, ESA F-01, 2nd Edition, ESTEC, Noordwijk, The Netherlands, January 1989.

channels. MOP-2 was orbited in March 1991,<sup>2</sup> and MOP-3, the sixth spacecraft of the Meteosat series, will be ready for launch in late 1993. It will have an expected seven-year life.

The MOP satellites are developed and operated by ESA on behalf of the European Organisation for the Exploitation of Meteorological Satellites (Eumetsat).<sup>3</sup> Formed in January 1987, Eumetsat is composed of 16 member states: Belgium, Denmark, Finland, France, Germany, Greece, Ireland, Italy, The Netherlands, Norway, Portugal, Spain, Sweden, Switzerland, Turkey, and the United Kingdom. Eumetsat manages the operational Meteosat program, while ESA procures, launches and operates the spacecraft on a reimbursable basis for Eumetsat. In general, the Meteosat/MOP spacecraft design, instrumentation, and operation are similar to the U.S. NOAA SMS/GOES spacecraft. The spin-stabilized spacecraft carry:

- a visible-infrared radiometer to provide high-quality day/night cloud cover data and to take radiance temperatures of the Earth's atmosphere, and
- a meteorological data collection system to disseminate image data to user stations, to collect data from various Earth-based platforms, and to relay data from polar-orbiting satellites.

The satellite's principal payload is a high-resolution radiometer. This instrument allows imaging of the Earth in three spectral bands: visible light; thermal infrared; and infrared "water vapor" (see table D-1).

Meteosat spacecraft are positioned to survey the whole of Europe, as well as most parts of Africa, the Middle East and the Atlantic Ocean. The satellites relay images and data to the Meteosat Operations Control Centre within ESA'S Space Operations Control Centre in Darmstadt, Germany. The Meteorological Information Extraction Centre, located within the Meteosat control center, distributes the satellite data to various users.

Meteosat is part of a program involving four geostationary satellites (nominally, two American, one European and one Japanese) that constitutes the basis of the World Weather Watch of the Global Atmosphere Research Program. Data from the Meteosat series is received in Europe directly from the satellites and relayed to the United States.<sup>4</sup> Meteosat data are used in various international research projects. Recently, as the result of an agreement between Eumetsat and NOAA, ESA moved Meteosat to a position of 75°W longitude in order to provide better coverage of the United States (see ch. 3).<sup>5</sup>

### Eumetsat

Eumetsat manages the Meteosat series of geostationary satellites and is NOAA's partner in the follow-on NOAA-K, L, and M satellites. Eumetsat is headquartered in Darmstadt, Germany, and is establishing a remote sensing ground infrastructure, including data processing and archives. Eumetsat is developing user access policies for full and open access to data in the meteorological tradition, but is also providing incentive for European countries to become members and share the financial burden of maintaining and improving operational meteorological services. Non-member countries are likely to pay for data through royalties or license fees. Encryption of satellite data would allow enforcement of any Eumetsat pricing policies.<sup>6</sup>

The Meteorological Information Extraction Centre in Darmstadt develops products in support of the International Satellite Cloud Climatology Project, with selected products supplied to the Global Telecommunications System of the World Meteorological Organization (WMO) as part of the World Weather Watch. These data are archived at ESA'S Operations Control Centre, which also controls and operates the Meteosat satellites for Eumetsat.

### European Remote Sensing Satellite (ERS)

The ERS-1 satellite was launched into polar orbit by an Ariane booster in July 1991 and was declared

<sup>2</sup> MOP-2: *Meteosat Operational Programme*, ESA/EUMETSAT, European Space Agency, ESA C-6, January 1991.

<sup>3</sup> "ESA Hands over Meteosat-5 to EUMETSAT," *ESA News Release*, No. 2, European Space Agency, Paris, France, Jan. 14, 1992.

<sup>4</sup> NOAA archives Meteosat data for use in the U.S.

<sup>5</sup> "Meteosat-3 to the Rescue . . . of NOAA," in *ESA Newsletter*, No. 9, European Space Agency, Paris, France, November 1991.

<sup>6</sup> Lisa R. Shaffer, "The Data Management Challenge," presented at Annual Meeting of the American Association for the Advancement of Science, Washington, DC, February 1991.

Appendix D-Non-US. Earth Observation Satellite Programs I 169

Table D-I—Spectral Coverage of Selected Remote Sensing Satellites

Satellite	Landsat 5	Landsat 6	NOAA-11	NOAA-12	GOES	TOPEX/Poseidon
Owner	U.S.	U.S.	U.S.	U.S.	U.S.	U.S.
Launch Date	1985	1993*	9-88	5-91	5-87	12-92
Average Resolution	30 m	30 m/15 m	1 km/4 km	1 km/4 km	4 km	2-10 cm
Swath Width	185 km	185 km			3000 km	N/A
<i>Spectral Coverage:</i>						
Ultraviolet	N/A	N/A	N/A	N/A	N/A	N/A
Blue	.45-.52	.45-.52	N/A	N/A	.55-.75	N/A
Green	.52-.60	.52-.60	.58-.68	.58-.68	.55-.75	N/A
Red	.63-.89	.63-.89	N/A	N/A	.55-.75	N/A
Near Infrared	.76-.90	.76-.90	.72-1.10/ 3.55-3.93	.72-1.10/ 3.55-3.93	N/A	N/A
Mid Infrared	1.55-1.75/ 2.08-2.35	1.55-1.75/ 2.08-2.35	N/A	10.5-11.5 11.5-12.5	N/A	N/A
Thermal IR	10.4-12.5 (120 km res)	10.4-12.5 (120 km res)	N/A	N/A	9.7-12.8/12.3- 13.0	N/A
Microwave	N/A	N/A	N/A	N/A	N/A	13.6;5.3;18.0;21.0;3 7.0;13.65 GHz
Panchromatic	N/A	15 m	N/A	N/A	N/A	N/A

\* Anticipated launch



Table D-I-Spectral Coverage of Selected Remote Sensing Satellites-Continued



---

<sup>7</sup>ERS-1 Now Declared Operational, “*ESA News Release*, European Space Agency, Paris, France, Jan. 27, 1992.

Appendix D—Non-U.S. Earth Observation Satellite Programs | 171

Satellite	Meteor 2	Meteor-3	Okeon-0	Resurs-0	Resurs-F	FY-1B	IRS 1-B
<b>Owner</b>	CIS	CIS	CIS	CIS	CIS	China	India
<b>Launch Date</b>	Numerous	8-91	2-90	4-88	5-91, 6 launched in 1990-91	9-90	3-88/8-9 1
<b>Average Resolution</b>	2 km/1km	.5 km	200 m-600 m	10-30 m	10-30 m	1.1 km	72 m
<b>Swath Width</b>	2100/2600 km	2600 km	variable	180 km	180 km		148 km
<b>Spectral Coverage</b>							
Ultraviolet	NIA	.25-.38 (3-5 km rcs)	N/A	N/A	NIA	NIA	N/A
Blue	NIA	N/A	NIA	NIA	NIA	.48-53	45-.52
Green	.50-.70	.50-.80	50-.60	.50-60	NIA	.53-.58	52-59
Red	NIA	NIA	60-70 (2 channels)	60-70	.63-70 (6 channels,	.58-68	62-68
Near Infrared	NIA	NIA	70-80 .80-1 10	NIA	NIA	.725 -1.10	.77-86
Mid Infrared	8-12 (8 km rcs.)	10-12.50 11.5012.50	1050-1150 1150-1250	.70-80 80-1.10	N/A	10.5 -12.5	NIA
<b>Thermal IR</b>	141-18.7 (30 km rcs)	9.65-187 (42 km rcs)	NIA	104-126	N/A	NIA	N/A
Microwave	NIA	NIA	.8 cm band/6- 15 km rcs, 3.15 cm band/1 -2 km rcs	.8-4.5 cm band 17-90 km rcs 9.2 cm SAR 200 m rcs	NIA	N/A	NIA
<b>Panchromatic</b>	N/A	N/A	NIA	N/A	N/A	N/A	365 m 7425 km

operational six months later.<sup>7</sup> Operating from a sun-synchronous, near-polar orbit, ERS-1 is the largest and most complex of ESA'S Earth observation satellites.<sup>8</sup> The ERS-1 platform is based on a design developed for the French SPOT program.

From a 98.5-degree orbit at 785-km altitude, ERS-1 makes use of a synthetic aperture radar (SAR) to study the relationships between the oceans, ice, land, and the atmosphere. The SAR'S all-weather, day-and-night sensing capability is critical for polar areas that are frequently obscured by clouds, fog, or long periods of darkness.

The primary mission objectives of ERS-1 include:<sup>9</sup>

- improving understanding of oceans/atmosphere interactions in climatic models;
- advancing the knowledge of ocean circulation and transfer of energy;
- providing more reliable estimates of the mass of the Arctic and Antarctic ice sheets;
- enhancing the monitoring of pollution and dynamic coastal processes;
- improving the detection and management of land use change.

Data from ERS-1 allows researchers to:

- study ocean circulation and global wind/wave relationships;
- monitor ice and iceberg distribution;
- more accurately determine the ocean geode;
- assist in short and medium-term weather forecasting, including the determination of wind speed;
- locate pelagic fish through monitoring of ocean temperature fronts.

The spacecraft's synthetic aperture radar provides all-weather, high-resolution (30 meters) imagery in 100-km-wide swaths over oceans, polar regions, and land. A core suite of onboard microwave sensors is supported by additional instruments (see table D-1).

ESA has developed a ground system for ERS-1, including centers for receiving, processing, validating, disseminating and archiving data:

- *the Mission Management and Control Centre (MMCC) in Darmstadt, Germany, which carries out all satellite operations control and management, including instrument operational scheduling;*
- *ESA ground stations at Kiruna (Sweden), Fucino (Italy), Gatineau and Prince Albert (Canada), and Maspalomas (Canary Islands, Spain) which provide the main network for data acquisition and the processing/dissemination of fast-delivery products;*
- *national ground stations around the world receive ERS-1 high-rate data by arrangement with ESA, extending the coverage potential of the high-resolution SAR imaging mission. One such ground station, funded by NASA, is the Alaska SAR facility at the University of Alaska Fairbanks. This facility, combined with two SAR stations in Canada and one in Sweden, provide nearly complete satellite coverage of Alaska and the Arctic for the first time;*<sup>10</sup>
- *the Earthnet ERS-1 Central Facility (EECF) in Italy, which carries out all user interface functions, including cataloging, handling of user requests, payload operation planning, scheduling of data processing and dissemination, quality control of data products and sensor performance monitoring;*
- *Processing and Archiving Facilities (PAFs) located in the United Kingdom, Germany, France, and Italy which are the main centers for the generation of off-line precision products and the archiving of ERS-1 data and products;*
- *user centers and individuals, such as national and international meteorological services, oceanographic institutes, and various research centers.*

<sup>7</sup> "ERS-1 Now Declared operational," *ESA News Release*, European Space Agency, Paris, France, Jan. 27, 1992.

<sup>8</sup> *The Data Book of ERS-1: The European Remote Sensing Satellite*, ESA BR-75, European Space Agency Publications Division, ESTEC, Noordwijk, The Netherlands, 1991. Pam Vass, and Malcolm Handoll. *UK ERS-1 Reference Manual*, DC-MA-EOS-ED-0001, Issue No. 1.0, Royal Aerospace Establishment, Farnborough, UK, January 1991.

<sup>9</sup> R. Holdaway, "UK Instruments for Mission to Planet Earth," presented at 42nd Congress of the International Astronautical Federation (IAF), (IAF-91-139), Montreal, Canada, Oct. 5-11, 1991; Ian Pinker, "Satellite Sees All," *Space*, vol. 7, No. 6, November/December 1991, pp. 8-12.

<sup>10</sup> "Satellite Facility Ready as ERS-1 Launched," *Geophysical Institute Quarterly*, vol. 9, Nos. 3 & 4, Fairbanks, Alaska, summer 1991.

An ERS-2 spacecraft, a follow-on mission to ERS-1, is an approved ESA project for launch in 1994, thereby offering uninterrupted data collection from 1991 until the initiation of ESA'S Polar Orbit Earth Observation Missions (POEM) program scheduled to begin orbital operations in 1998. ESA will first launch Envisat, an experimental ecological monitoring satellite. Later, around 2000, ESA will launch the Metop satellite, designed to provide operational meteorological data. Eumetsat will provide data from the Metop system in cooperation with NOAA (see ch. 3 and ch. 8), ERS-2, along with ERS-1 instrumentation, will carry the Global Ozone Monitoring Experiment package to analyze atmospheric chemistry, using medium-resolution spectrometry in the ultraviolet and visible regions of the spectrum to examine ozone and other chemical substances in the troposphere and stratosphere.

The ERSC Consortium (Eurimage, Radarsat International, and SPOT Image Consortium) is responsible for worldwide commercial distribution of ERS-1 data and products to users. Eurimage is owned by four companies: Telespazio (Italy), Dornier (Germany), Satimage (Sweden), and British Aerospace (United Kingdom), with each as a 25 percent shareholder. Eurimage is responsible for the distribution of all ESA products within Europe and the Middle East, Radarsat distributes products in North America. SPOT is responsible for distribution to remaining world markets.<sup>11</sup>

The European Space Agency's remote sensing data management program is called Earthnet.<sup>12</sup> This group is headquartered in Frascati, Italy, at the European Scientific Research Institution (ESRIN).<sup>13</sup> ESA primarily serves European users, but data from Earthnet are available to any user for a price, either directly or through Eurimage. Earthnet provides basic remote sensing data in digital and photographic format, while higher level products are turned over to value-added firms for production and distribution. Users from

countries who contributed to the cost of the program are given preferential prices.

## FRANCE

### Systeme Probatoire d'Observation de la Terre (SPOT)

The SPOT-1 spacecraft was launched in February 1986 by Centre National D'Etudes Spatiales (CNES), the French space agency, as an operational, commercial satellite. The SPOT program represents a \$1.7 billion investment through the end of the decade.<sup>14</sup> CNES acts as overall program leader and manager with full responsibility for satellite launches and orbital control and related funding. Government/industry organizations participating in the SPOT program are led by CNES, the Swedish Space Corporation in Sweden, and the Societe Nationale d'Investissement of Belgium.

SPOT-1 was placed in a sun-synchronous, near-polar orbit of 824 X 829 km altitude, with a design lifetime of two years. Every 369 revolutions around the Earth (every 26 days), SPOT-1 arrives at the same place over the globe. SPOT-1 carries twin pushbroom CCD High Resolution Visible (HRV) Imaging Instruments. The HRV can point up to 27 degrees off the satellite track, allowing the satellite to reimage places on the surface within 2 or 3 days. Also onboard are two magnetic tape data recorders and a telemetry transmitter. Until December 1990, the HRV observed in three spectral bands in multispectral mode with a swath width (nadir viewing) of 60 km; and in panchromatic mode with a swath width of 60 km (see table D-1). SPOT-1 attained a ground resolution of 20 meters in multispectral mode, and 10 meters in panchromatic mode. SPOT-1 off-nadir viewing yielded stereoscopic pairs of images of a given area during successive satellite passes. A standard SPOT-1 scene covers an area 60 X 60 km.

SPOT-1 lifetime of two years stretched until its first retirement in 1990, after suffering from a failing

<sup>11</sup> Peter de Selding, "ESA Signs Long-awaited Imagery Sales Deal," *Space News*, vol. 3, No. 5, Feb. 10-16, 1992, pp. 4; "ESA Initiates Commercial Distribution of ERS-1 Data," *ESA News Release*, No. 8, European Space Agency, Paris, France, Feb. 7, 1992.

<sup>12</sup> Shaffer, *op. cit.*, footnote 6.

<sup>13</sup> Earthnet was originally established to receive and make available Earth observation data from non-ESA satellites, such as Landsat and MOS, Tires-N, Seasat, HCMM, Nimbus-7, and SPOT, but is now the focal point for ESA remote sensing data management, with substantial ERS-1 responsibilities.

<sup>14</sup> *Launching SPOT 2-Information File*, Centre National d'Etudes Spatiales, Toulouse France, 1989; "France: Remote Sensing Program," in *Science and Technology Perspectives*, Foreign Broadcast Information Service, vol. 5, No. 4, Apr. 30, 1990, pp. 11-12.

**onboard tape recording system. The satellite was reactivated in March 1992,<sup>15</sup> with ground operators making use of SPOT-1 imaging instruments and real-time acquisition mode. By providing operational service, SPOT-1 is being used to meet a data demand during the northern hemisphere growing season, and to reduce the workload on SPOT-2 over high-demand areas.**

SPOT-2 was launched in January 1990 as a replica of SPOT-1. Only minor modifications were used in the building of SPOT-2: use of improved charge coupled devices (CCD); improved calibration housing; and the addition of a high-precision orbit determination system.

A SPOT-3 has been built and is ready for launch when needed, to assure continuity of SPOT services until the year 2000. SPOT-3 will exhibit the same capability as the first two SPOT spacecraft, but will also carry a Polar Ozone and Aerosol Measurement instrument for the USAF Space Test Program.

SPOT-4 has been approved for development, and should be ready in 1994 in the event of a SPOT-3 failure. SPOT-4 is considered the first of the second-generation Earth observation platform series. SPOT 4 will be built around an improved platform that will have an expected operational life of five years.<sup>16</sup> SPOT-4 will have increased on-board instrumentation capacity and performance, including more than double the electric, computing, and recording capacity. The High Resolution Visible Imaging Sensors carried onboard SPOTS 1-3 are to be upgraded to High Resolution Visible Infra-Red by the addition of a mid-infrared band (1.58-1.75 microns).<sup>17</sup>

Beyond SPOT-4, discussions are underway concerning synthetic aperture radar and optical instruments, such as a new stereo, high-resolution imager.<sup>18</sup> CNES is studying the potential for developing a

microwave subfamily within the SPOT family of remote sensing satellites using the SPOT-4 spacecraft bus. Using a synthetic aperture radar, such a spacecraft could be introduced in parallel with the optical SPOT family after 2000.<sup>19</sup> The radar-carrying satellite would be operated on a commercial basis and would maximize use of the SPOT receiving station network, as well as commercial and product delivery facilities.

SPOT satellites transmit data to an expanding network of receiving stations. Major space imagery receiving stations are located at Toulouse, France, and in Kiruna, Sweden. Other receiving stations capable of receiving SPOT data are located in Canada, India, Brazil, Thailand, Japan, Pakistan, South Africa, and Saudi Arabia, as well as the European Space Agency's station in the Canary Islands, Spain. Actual operation of the satellite is carried out by CNES at SPOT mission control in Toulouse.

Formed in 1978 and located in Reston, Virginia, SPOT Image, Inc. provides U.S. businesses, universities, and government agencies a range of products and services based on SPOT data.<sup>20</sup> The worldwide commercial headquarters, SPOT Image, S. A., is anchored in France, with SPOT Imaging Services in Australia and SPOT Asia located in Singapore. SPOT distributors are present in over 50 countries around the world.

## Helios

Common with the development of a SPOT-4 is the Helios reconnaissance satellite being built for the French Ministry of Defense.<sup>21</sup> This satellite received approval in 1988. Italy and Spain are partners in this project, contributing 14 percent and 7 percent of the funding, respectively. Helios will have a reported resolution of about 1 m. Helios-1 should be ready for launch in 1994, possibly followed 2 years later by Helios-2.

<sup>15</sup> "SPOT-1 Resumes Operational Service," *SPOT Image Corporation Press Release*, Reston, VA, Mar. 27, 1992.

<sup>16</sup> J.M. Au & C. Billard, and P. Ranzoli. "The SPOT MKII Bus, A Key to Earth Observation in the '90s," presented at the 42nd Congress of the International Astronautical Federation (IAF-91-013), Montreal, Canada, Oct. 5-11, 1991.

<sup>17</sup> C. Fratter, Alain Baudoin et al., "A Stereo, High Resolution Concept for the Future of the SPOT Program," presented at the 42nd Congress of the International Astronautical Federation (IAF-91-128), Montreal, Canada, Oct. 5-11, 1991.

<sup>18</sup> D. Seguela, J.P. Durpaire et al., "GLOBSAT: A French Proposal for Earth Environment Monitoring from Polar Orbit," @F-91-120), Montreal Canada, Oct. 5-11, 1991.

<sup>19</sup> J.P. Aguttes, D. Massonnet, and O. Grosjean. "A New Radar System for the French Program in the '00s," presented at 40th Congress of the International Astronautical Federation (IAF-89-124), Malaga, Spain, Oct. 7-13, 1989.

<sup>20</sup> Stephane Chenard, "SPOT's Subsidized Success Story," in *Space Markets*, February 1990, pp. 102-103.

<sup>21</sup> *Annual Report 1990*, Centre National D'Etudes Spatiales (CNES), Paris, France, pp. 65-68.

The Ministry of Defense has appointed CNES to act as overall system architect for Helios and has given it procurement responsibility for the Helios segment. The Western European Union (WEU) has established a facility in Torrejon, Spain, to analyze images from SPOT and Landsat. It will also receive some imagery from Helios.<sup>22</sup>

### TOPEX/Poseidon

Launched in July 1992 aboard an Ariane booster, TOPEX/Poseidon is studying the topography of the ocean's surface and ocean currents worldwide. The project is a joint undertaking, initiated in September 1983 between France and the United States. The spacecraft is the result of the merger of two similar programs: NASA's Ocean Topography Experiment (TOPEX) and France's CNES Poseidon experiment.

The launch marked the first time a NASA spacecraft was launched by an Ariane booster.<sup>23</sup> The satellite should operate for at least three years and is comprised of two French and five U.S. instruments: a NASA radar altimeter; a NASA laser retroreflector assembly; a NASA frequency reference unit; a NASA TOPEX microwave radiometer; a Jet Propulsion Laboratory global positioning system demonstration receiver; a CNES solid state altimeter; and the CNES Determination d'Orbite et Radiopositionnement Integre par Satellite (DORIS) receiver.

From its 1,334-km altitude, the TOPEX has a fixed ground track that repeats every 127 circuits of Earth (9.9 days). Using NASA tracking and data relay satellites, as well as laser tracking from the ground, the satellite's orbit around the Earth can be pinpointed within an accuracy of 13 centimeters. A comparison of the distance between satellite and sea surface with the distance between the satellite and the Earth's center allows for accurate topographic mapping of the ocean.

The U.S. radar altimeter operates with a prime channel of 13.6 GHz in the Ku-band and a secondary channel at 5.3 GHz in the C-band. The microwave radiometer is a four-channel, three-frequency sensor that operates at 18, 21, and 31 GHz to measure the correction for the tropospheric water vapor content of

the altimeter nadir column to an accuracy of 1.2 cm. The French radar altimeter is a single-frequency (13.65 GHz) experimental sensor, with an accuracy of about 2 cm. The CNES DORIS dual-frequency (401 and 2036 Mhz) dopplerreceiver achieves an accuracy of 10 cm.

Data received from the TOPEX/Poseidon will assist in the World Ocean Circulation Experiment (WOCE), and the Tropical Ocean Global Atmosphere (TOGA) program.

### JAPAN

The Japanese are engaged in an active remote sensing satellite program and are expected to expand their work in this arena, both in ground and space segments.<sup>24</sup> Movements into the commercial sales of remote sensing data seem likely, as Japan moves into a continuity of data flow from their own Earth Resources Satellite (JERS-1) and the Advanced Earth Observing Satellite (ADEOS).

### The Geostationary Meteorological Satellite (GMS)

GMS "Himawari" series satellites have contributed to the improvement of Japan's meteorological services and development of weather satellite technology.<sup>25</sup> Data gathered by the GMS satellites are shared with the World Weather Watch, Operational weather data, including monitoring of cloud cover, temperature profiles, real-time storm monitoring, and severe storm warning, are key missions objectives of the GMS series. The cloud distribution pictures are used in countries of Southeast Asia and the Western Pacific.

The first satellite in the GMS series was launched by a U.S. Delta rocket in July 1977, with later GMS satellites boosted by Japan's own N-II and H-1 rockets. GMS-2 and the GMS-3 were launched in August 1981 and August 1984, respectively, with the H-1 launching the GMS-4 in September 1989. Now under development for a projected 1994 launch is the GMS-5, which is expected to conclude the series.

Japan's space agency, NASDA, developed the first two GMS satellites and the Japan Meteorological

<sup>22</sup> Peter B. deSelding, "Potential Partners Give Helios Follow-On Cool Response," *Space News*, June 28, p. 5.

<sup>23</sup> R. Hall, "TOPEX/Poseidon Satellite: Enabling a Joint U. S. French Mission for Global Ocean Study," presented at 41st congress Of the International Astronautical Federation, (IAF-90-101), Dresden, Germany, Oct. 6-12, 1990.

<sup>24</sup> NASDA-National Space Development Agency of Japan, Tokyo, Japan, 1991.

<sup>25</sup> Geostationary Meteorological Satellite-5, National Space Development Agency of Japan, 3/10T, Tokyo, Japan, 1991.

Agency was in charge of the installation of ground facilities needed for their operations. Since GMS-3, the two agencies share the development costs of the satellite. NASDA is responsible for development efforts, while the Japan Meteorological Agency manages the operation of the satellites and the distribution of data.

Design of the GMS, which is manufactured by Hughes Communications and Space Group and Japan's NEC, draws heavily from the Hughes-built U.S. GOES meteorological satellite. The GMS satellites are spin-stabilized, and carry radiometers, the space environment monitor, along with a data collection system, which gathers environmental data from ground-based instruments. The GMS-3 was replaced by the GMS-4 as the primary GMS satellite, but is still capable of transmitting cloud photos over the earth 28 times per day. GMS-4 provides 1.25-km resolution in the visible channel, and 5-km resolution in the infrared channel. Sensors onboard the GMS-4 include a single imaging Visible and Infrared Spin Scan Radiometer (VISSR) operating in 0.5 to 0.75 microns visible band and 10.5 to 12.5 microns in the infrared band. This instrument provides a full-disc Earth image in less than a half hour, simultaneously in both visible and infrared bands. The visible channel consists of four detectors (with four backup detectors) that scan simultaneously, covering a 1.1-km area. The GMS-4 also carries a space environment monitor to survey radiation levels at geostationary altitude and to monitor solar protons, electrons, and alpha particles.

GMS-5 will be launched in late 1994, and will be similar to the GMS-4 design. It will carry a Search and Rescue experiment on behalf of the Ministry of Transport of Japan.

#### Marine Observation Satellite (MOS-1, MOS-1b)

The MOS-1 is Japan's first domestically developed Earth observation satellite.<sup>26</sup> MOS-1 was launched in February 1987 from Tanegashima Space Center by an N-II rocket. Its successor, MOS-1b, was launched by a H-I rocket in February 1990. These spacecraft were sent into a sun-synchronous orbit of approximately 909 km and have a 17-day recurrent period, circling the

Earth 14 times a day. The two spacecraft can be operated in a simultaneous and/or independent mode.

MOS-1 and MOS-1b (also called MOMO-1 and MOMO-1b) are dedicated to the following mission objectives:

- Establishment of fundamental technology for Earth observation satellites;
- Experimental observation of the Earth, in particular the oceans, such as water turbidity of coastal areas, red tide, ice distribution; development of observation sensors; verification of their functions and performance;
- Basic experiments using the MOS data collection system.

Each of the spacecraft carries three sensors: a Multispectrum Electronic Self-Scanning Radiometer; a Visible and Thermal Infrared Radiometer and a Microwave Scanning Radiometer (table D-1). Both satellites are designed for a two-year lifetime.

Facilities to receive data directly from the MOS series are located at Japan's Earth Observation Center in Hatoyama-cho, Hiki-gun, Saitama prefecture. Data processing facilities have also been set up by NASDA at the Remote Sensing Center of the National Research Council of Thailand, located in a suburb of Bangkok. This Thailand station can receive MOS data over Thailand, Bangladesh, Bhutan, Cambodia, Malaysia, Vietnam; and part of China, India, Indonesia, Nepal and Philippines. The Thailand collection center transports monthly data to Japan's Earth Observation Center and NASDA for processing and generation of products.

MOS products are available for a fee from the Remote Sensing Technology Center of Japan (RESTEC). RESTEC was established under the guidance of the Science and Technology Agency and NASDA in 1975 as a foundation, with the assistance of Mitsui & Co., Ltd. and the Mitsubishi Corporation.

#### Earth Resources Satellite-1 (JERS-1)

JERS-1 is a joint project of the Science and Technology Agency, NASDA, and the Ministry of International Trade and Industry (MITI). JERS-1 was

<sup>26</sup> *Marine Observation Satellite-i*, National Space Development Agency of Japan, 8/5T, Tokyo, Japan, 1990. Keiji Maruo, "Remote Sensing Activities in Japan," in *Space Commercialization: Satellite Technology*, edited by F. Shahrokhi, N. Jasentuliyana, and N. Tarabzouni, vol. 128 of *Progress in Astronautics and Aeronautics*, American Institute of Aeronautics and Astronautics, Washington, DC, 1990.

<sup>27</sup> *Earth Resources Satellite-1*, National Space Development Agency of Japan, 3/10T, Tokyo, Japan, 1991.

launched by an H-I rocket in February 1992,<sup>27</sup> Problems with a balky radar antenna were overcome in the early months of the mission.

The JERS-1 is Japan's third domestic remote sensing satellite (following the MOS-1 and MOS-1b) and will observe Earth using optical sensors and an L-band SAR for two years. JERS-1 will enable the overlaying of optical multispectral data with all-weather radar imagery. JERS-1 was placed in a sun-synchronous orbit of approximately 570 km. Its recurrent period over the same location is 44 days.

The primary purpose of JERS-1 is to verify functions and performance of optical sensors and a synthetic aperture radar, and to establish an integrated system for observing the Earth's resources. Earth observations are to focus on land use, agriculture, forestry, fishery, environmental preservation, disaster prevention, and coastal zone monitoring.

The JERS-1 radar system has day/night and all-weather observation capabilities. Resolution of the radar is 18 meters with a swath width of 75 km. The SAR is capable of an off-nadir angle of 35 degrees (table D-1). An onboard recorder records SAR and OPS data when no data receiving station is available, allowing JERS-1 to attain global coverage.

In Japan, JERS-1 data are received at NASDA's Earth Observation Center, Saitama. In addition, JERS-1 data are received at the Tokai University in Kumamoto Prefecture, the Showa Base in the Antarctic, and the Thailand MOS-1 station. Under a NASDA-NASA Memorandum of Understanding, the NASA-funded SAR station in Fairbanks, Alaska, also receives JERS-1 data. These data overlap the SAR data from the already-orbiting European ERS-1 mission and the Canadian Radarsat mission, planned for launch in 1994.

#### Advanced Earth Observation Satellite (ADEOS)

The main objective of ADEOS, the next generation of Japanese Earth observation satellites, is to continue and further advance Earth observation technology spurred by the MOS-1 and JERS-1 programs. The spacecraft is to have a 3-year lifetime.<sup>28</sup> ADEOS will have a sun-synchronous, 98.6 degree inclination orbit

with a crossing time of 10:30 am, and a repeat cycle of 41 days.

ADEOS will verify functions and performance of two NASDA sensors, the Ocean Color and Temperature Scanner (OCTS) and the Advanced Visible and Near Infrared Radiometer (AVNIR). The OCTS will be used for marine observation with high precision, and the AVNIR for land and coastal observation with high resolution.<sup>29</sup>

NASA plans to fly the Total Ozone Mapping Spectrometer (TOMS) aboard ADEOS, as well as a NASA Scatterometer (NSCAT), which will provide accurate measurements of ocean surface winds. Such a device was demonstrated during the U.S. Seasat program in 1978.

Along with the U.S.-provided sensors, the Interferometric Monitor for Greenhouse Gases (IMG) will be provided by the Ministry of International Trade and Industry of Japan, the Improved Limb Atmospheric Spectrometer and the Retroreflector in Space will be provided by the Environment Agency of Japan. Lastly, the Polarization and Directionality of the Earth's Reflectance (POLDER) instrument is to be provided by the French space agency, CNES.

The ADEOS program will also conduct experiments on Earth observation data relay using the Engineering Test Satellite-VI and the Experimental Data Relay and Tracking Satellite to enhance global observation capabilities. Lastly, Japanese officials expect to demonstrate the ADEOS modular design they believe necessary to build future Japanese polar-orbiting platforms.

ADEOS was initially to be launched by the H-II rocket in early 1995, but delays in the H-II program and problems integrating non-Japanese instruments have caused a slip in schedule. Japan now plans a February 1996 launch.

The OCTS instrument planned for ADEOS is to be a multispectral radiometer designed to measure global ocean color and sea surface temperature simultaneously during the day. It is based on the VTIR instrument flown on the MOS-1 series. OCTS spatial resolution will be approximately 700 meters, with a 1,400-km swath width. The OCTS will be pointable on

<sup>28</sup> (ADEOS) *Advanced Earth Observing Satellite*, National Space Development Agency of Japan, 3/10T, Tokyo, Japan, 1991.

<sup>29</sup> N. Iwasaki, Makoto Kajii et al., 'Status of ADEOS Mission Sensors,' presented at 42d Congress of the International Astronautical Federation (IAF-91-144), Montreal, Canada, Oct. 5-11, 1991.



## 178 I Remote Sensing From Space

command and capable of tilting along track to either side of nadir.

The AVNIR is a high spatial resolution multispectral **radiometer for Earth observing during the day in visible and** near-infrared regions. AVNIR is a third-generation sensor using CCD technology, preceded by MESSER of the MOS-1 and OPS of the JERS-1. The sensor swath width is approximately 80 km. AVNIR is equipped with a pointing mechanism that selects the observing path arbitrarily in the cross track direction of ADEOS flight.

Major specifications of the sensors aboard ADEOS are as follows:

- The NASA *Scatterometer (NSCAT)* can measure surface wind speed and direction over the global oceans. Swath width: 1,200 km; frequency: 13.995 GHz; wind speed measurement accuracy: 2 m/s.; direction accuracy of 20 degrees (at spatial resolution of 50 km). This sensor will observe globally, day and night;
- The NASA *Total Ozone Mapping Spectrometer (TOMS)* will observe ozone changes, **evaluate** changes in ultraviolet radiation and sense sulfur dioxide in the atmosphere. Swath width: 2,795 km; wavelengths: 304.0, 312.5, 325.0, 317.5, 332.6 and 360 microns. This sensor will operate in the day on a global basis;
- The CNES *Polarization and Directionality of the Earth's Reflectance (POLDER)* sensor will observe solar radiation reflected by the Earth's atmosphere. Swath width: 1,440 X 1,920 km; wavelengths: 0.443, 0.490, 0.520, 0.565, 0.670, 0.765, 0.880, 0.950 microns. This device will operate in the day on a global basis;
- MITT's *Interferometric Monitor for Greenhouse Gases (IMG)* will observe carbon dioxide and other greenhouse gases. Swath width: 20 km; wavelengths: 3.3-14 microns. This sensor will observe globally, day and night;
- Environment Agency of Japan's *Improved Limb Atmospheric Spectrometer (ILAS)* will observe the micro-ingredients in the atmosphere over high-latitude areas on the Earth's limb. Wave-

lengths: 0.75-0.78 and 6.2-11.8 microns. This sensor will operate on a regional basis;

- Environment Agency of Japan's *Retroreflector in Space (RIS)* that measures ozone, fluorocarbons, carbon dioxide, etc., by laser beam absorption. Laser beam is transmitted from ground station and reflected on ADEOS. Wavelengths: 0.3-14 microns. This experiment will be done on a regional basis.

Mission operation of ADEOS will be controlled from the NASDA Earth Observation Center (EOC). However, the limited visibility of ADEOS by the EOC will require use of foreign, near-polar ground stations as well, Data rate for direct transmission from ADEOS is a maximum of 100 megabits per second (Mbps).

### Future Planning

Future plans by Japan in Earth observation satellites center on a number of post-ADEOS sensors and satellites, as well as enhancement of the remote sensing ground segment, data networks, remote sensing training activities, and marketing.<sup>30</sup>

*Tropical Rainfall Measurement Mission (TRMM)-TRMM* is detailed in appendix A.

*Japanese Polar Orbiting Platform (JPOP)*-- Japanese officials expect this platform to succeed ADEOS in the late 1990s and to constitute a Japanese contribution to the international Earth observation system. The JPOP is expected to be launched by H-II rocket into Sun-synchronous orbit after 1998.

*Ground Facilities*—Use of NASDA'S Earth Observation Center (EOC) will increase given its role in the data reception and processing of Landsat, SPOT, MOS-1, MOS-1b, JERS-1 and ADEOS data.

### Data Distribution

The role of the Remote Sensing Technology Center of Japan (RESTEC) will likely grow in future years.<sup>31</sup> RESTEC handles data distribution for Landsat, MOS, and SPOT to general users in Japan and foreign customers. NASDA data policy for MOS-1 is to charge for the cost of reproduction and handling. NASDA is responsible for processing JERS-1 data, but RESTEC

---

<sup>30</sup> *Monitoring the Earth Environment from Space: A Scenario of Earth Observation for the Next Decade*, National Space Development Agency of Japan (NASDA), Tokyo, Japan.

<sup>31</sup> RESTEC Remote Sensing Technology Center of Japan, To&o, Japan, 1991.

will distribute the NASDA-processed JERS-1 data to Japanese and foreign users.

Japanese geography and politics permit only one satellite tracking and receiving facility, which does not view Earth-orbiting spacecraft often enough to permit global data acquisition and relay to Earth of tape recorded data. Until Japan establishes a data relay satellite capability, it must rely on international cooperation to obtain data from its satellites.<sup>32</sup>

## COMMONWEALTH OF INDEPENDENT STATES (CIS)

The former Soviet Union's space activities show a great and expanding interest in Earth observation, not only for military purposes, but for assessing resources on a regional and global scale.<sup>33</sup>

Beyond military spaceborne reconnaissance assets, the Soviet meteorological and remote sensing programs have been forged into an integrated network, comprising various spacecraft. Today the CIS operates eight different types of space platforms—both piloted and automated spacecraft—that provide global environmental data, and it is proposing even more systems for the future.<sup>34</sup> This network is comprised of Meteor 2 and Meteor 3-series satellites; the Okean-O spacecraft; the Resurs-O, Resurs-F1 and Resurs-F2 satellites; and the piloted Mir space station complex.

Soviet authorities have claimed that their nation's meteorological and remote sensing satellites provide an economic savings of some one billion rubles each year. Indeed, Earth observation data are widely used in the former Soviet Union for land and forestry management, mapping soil erosion threats, studying ice situations in polar areas, and monitoring earthquake and avalanche hazards.<sup>35</sup>

### Meteor

Meteor was the first civil applications satellite deployed by the former USSR. It is comparable, in

many ways, to the U.S. NOAA series. Following a long stretch of testing under the Cosmos satellite label, the first Meteor was identified as such in 1969. Numbers of Meteor 1-class spacecraft were launched and then replaced (after 1975) by the current Meteor 2-class spacecraft and (after 1985), by the Meteor 3 satellite. Meteor 2 and Meteor 3 satellites are routinely launched, typically twice a year.

Meteor 2 satellites are placed in 950-km polar orbits, with two or three of this class of spacecraft in operation at all times. Grouped in a constellation, individual Meteor 2 satellites gather data from one-fifth of the globe during a single circuit of Earth, relaying data on clouds, ice cover, and atmospheric radiation levels. Two of these satellites provide 80 percent coverage of the Earth's surface in six hours.

Onboard a Meteor 2 satellite are scanning radiometers for direct imaging and global coverage; a scanning infrared radiometer for global coverage; and a scanning infrared spectrometer, covering eight channels (table D-1). Automatic Picture Transmission (APT) is carried out from a Meteor 2-class satellite at frequencies between 137 and 138 Mhz, therefore compatible with international APT formats. Some 15,000 APT terminals exist across the CIS territories.

The newer Meteor 3-class satellites are being placed into higher orbits, 1,200 km, in order to prevent coverage gaps in the equatorial regions. Payload of Meteor 3 spacecraft are similar to Meteor 2 satellites (table D-1). Also onboard Meteor 3-class spacecraft is a radiation measurement device to record electron and proton charges in the space environment.

The Meteor 3 satellites are designed to accommodate additional payload packages. For example, the August 1991 Meteor 3 launch carried NASA's Total Ozone Mapping Spectrometer (TOMS).<sup>36</sup> Russia plans to fly Earth radiation budget instruments provided by CNES aboard a future Meteor 3.

Russian authorities have discussed developing a Geostationary Operational Meteorological Satellite

<sup>32</sup> See Shaffer, op. cit. footnote 6.

<sup>33</sup> Nicholas L. Johnson, *The Soviet Year in Space 1990*, Teledyne Brown Engineering, Colorado Springs, CO, 1991.

<sup>34</sup> Neville Kidger, "The Soviet Unmanned Space Fleet," *Spaceflight*, vol. 32, July 1990, pp. 236-239.

<sup>35</sup> Marcia Smith, *Soviet Space Commercialization Activities*, CRS Report for Congress, Congressional Research Service, 88-473 SPR, Washington DC, July 6, 1988. Kazakov, Roudolf V. *Applications of Soviet Remote Sensing Data for Studies of Natural Resources and Mapping Purposes*. Sojuzkarta Company, Moscow, 1991.

<sup>36</sup> Brian Dunbar and Dolores Beasley, *NASA News*, "Soviets to Launch NASA Instrument to Study Ozone Levels," Release 91-127, NASA Headquarters, Washington, DC, Aug. 12, 1991; *NASA Meteor-3/TOMS Press Kit*, NASA Headquarters, Washington, DC, Aug. 12, 1991.

## 180 I Remote Sensing From Space

(GOMS) that would carry a sensor suite similar to the NOAA GOES-Next satellite series. Economic turmoil in Russia has delayed GOMS deployment. GOMS would acquire, in real time, television images of the Earth's surface and cloud cover in the visible (0.4-0.7 microns) and infrared (10.5 -12.5 microns ) regions of the spectrum, providing resolutions of 1-2 km and 5-8 km, respectively, with a total field of view of 13,500 km X 13,500 km.

### Okean-O

Toward the end of the 1980s, the former Soviet Union developed the Resurs system of remote sensing satellites, of which Okean-O is a part. Okean-O is a series of all-weather oceanographic satellites with real aperture side-looking radars. These satellites are built to provide all-weather monitoring of ice conditions; wind-induced seaway, storms and cyclones; flood regions; and ocean surface phenomena.

A standard Okean-O is placed in a 630- to 660-km orbit. The spacecraft carries a side-looking radar, a microwave scanning radiometer, a medium-resolution multispectral (4-channel) scanner and a high-resolution multispectral (2-channel) scanner.

Okean satellites make use of the APT frequency of 137.4 Mhz. A data collection and distribution system called Condor allows data to be culled by Okean spacecraft from ground-based instruments, then relayed to ground stations. These data can then be relayed directly to ships at sea via communications satellites.

A follow-on to Okean-O has been discussed for launch in 1993. Significant changes include addition of a second side-looking radar. The modified Okean would then provide coverage on both sides of the satellite's flight path, sweeping out a wider swath, but retaining the same resolution. In addition, a more advanced multispectral scanner will make use of three visible bands with a resolution of 200 meters and three infrared bands yielding a 600-meter resolution.

### Resurs-O

The Resurs-O spacecraft are roughly comparable to the U.S. Landsat system. These digital Earth resources satellites, derived from the Meteor series, circle Earth

at altitudes of 600 km to 650 km in sun-synchronous orbit. They carry a multiple multispectral instrument package, operating in the visible to thermal infrared, and have been touted for their ability to detect industrial pollution.<sup>37</sup> Remote sensing hardware aboard Resurs-O comprise two high-resolution, multiband (3-channel) CCD scanners, a medium-resolution multiband (5-channel) conical scanner, a multiband (4-channel) microwave radiometer, and a side-looking synthetic aperture radar. The Resurs-O spacecraft can process some data in orbit and relay realtime data at 7.68 mbps.

Russians officials plan a follow-on to this series carrying high-resolution optical sensors capable of 15- to 20-meter resolution. Discussions have also been held about establishing commercial Resurs-O receiving stations in Sweden, as well as the United Kingdom.

### Resurs-F

This class satellite mimics CIS military reconnaissance spacecraft by using a capsule containing exposed film that is ejected by the spacecraft and returned to Earth under parachute.<sup>38</sup> Resurs-F1 and Resurs-F2 spacecraft use the Vostok reentry sphere, used previously to launch the first cosmonauts into orbit.

The Resurs-F1 typically flies at 250 km to 400 km altitude for a two-week period and carries a three-channel multispectral system which includes three KATE-200 cameras and two KFA-1000 cameras. The KATE-200 camera provides three spectral bands for Earth observing (table D-1) at a swath width of 180 km. Stereoscopic imagery can be accomplished with an overlap of 20, 60, or 80 percent. Resolution varies, according to spectral band and survey altitude, from 10 to 30 meters. The KFA-1000 cameras provide 300 X 300 mm frame window size with images capable of being taken in stereo, with an overlap of 60 percent.

The Resurs-F2 spacecraft normally cover Earth in 3- to 4-week periods (sometimes as long as 45 days) in a variable orbit of 259 km to 277 km. Onboard is the MK-4 camera system which can survey the Earth using a set of four cameras, Six spectral channels from 0.635 to 0.700 are available. Imagery provided by Resurs-F1

<sup>37</sup> *Resurs-O-Space System for Ecological Monitoring*, The Soviet Association for the Earth Remote Sensing, Moscow, December 1990.

<sup>38</sup> "USSR: Orbital Materials Processing" also details Earth resources photographic return capsules. *Science and Technology Perspectives*, Foreign Broadcast Information Service, vol. 5, No. 6, June 29, 1990, pp. 5-7.

and F2 spacecraft are being offered commercially through the Soyuzkarta company.<sup>39</sup>

### Almaz

Recently, the CIS collected a wealth of data from its Almaz satellite. Almaz-1 was a large spacecraft equipped with synthetic aperture radar (SAR) for day/night operations. Launched in March 1991 and operated until October 1992, the Almaz followed a 300-km-high orbit, and provided coverage of an appointed region at intervals of one to three days. Its orbital position was corrected every 18-31 days, and accounted for considerable fuel use. The orbit was also changed frequently to comply with customers' requests. A similar bus-sized, radar-equipped prototype spacecraft-Cosmos-1 870-was launched in 1987, and was based upon that of the piloted Salyut and Mir space stations.<sup>40</sup> Cosmos- 1870 operated for two years, producing radar imagery of 25 to 30 meters resolution.

An Almaz Corporation was formed to stimulate commercial use of the satellite data. Glavkosmos, the civil space arm in Russia, NPO Machinostroyeniya, and the U.S.-based Space Commerce Corporation of Houston, Texas, established a joint Data Processing and Customer Support Center in Moscow to assist customers in using Almaz data. The French company, SPOT Image, also markets Almaz data in the United States and Canada. In 1992, Hughes STX Corp. of Lanham, Maryland, signed an agreement with Almaz Corp. of Houston to be exclusive worldwide commercial marketer, distributor, processor and licensor of data from the Almaz-1 spacecraft.<sup>41</sup> According to some reports, Almaz data sales have been slow; a sales target of \$2 million for 1992 may have been unrealistic.<sup>42</sup>

The Russians would like to launch and operate an Almaz-2. However, lack of capital and a weak market for Almaz data have prevented such arrangements.

### Mir

Since the first crew occupied the Mir space station in 1986, cosmonauts onboard the orbiting complex

have completed numerous experiments dedicated to Earth remote sensing. Various Earth imaging systems have been flown to the Mir, such as the Kate-200, KFA-1000, and the MK4 camera hardware also used on board the Resurs-1 and Resurs-2 satellites.

The Kavant-2 module, attached to the central core of the Mir in December 1989, carried the MKF-6M camera, capable of imaging Earth at a resolution of 22.5 m.

Of significance is the potential for further expansion of the Mir complex to include a Priroda remote-sensing module, which has been under development for several years. Russia plans to attach the Priroda module to Mir in late 1994. Use of instruments carried inside the module would be geared to monitoring ocean surface temperatures, ice cover, wind speed at the ocean surface, and surveying concentrations of aerosols and gases in the atmosphere.

## INDIA

India has invested heavily in space-based remote sensing. The Indian Space Research Organization (ISRO) is the primary government space agency for the country, organized under the government's Department of Space. The ISRO Satellite Centre is the primary laboratory for design, building, and testing of Indian satellites.

A National Remote Sensing Agency was established in 1975 and is charged with shaping an operational remote sensing system for India. Since 1979, India's central Earth station in Shadnagar has received U.S. NOAA spacecraft data, as well as information transmitted by Landsat, SPOT, and the country's own Indian Remote Sensing (IRS) spacecraft. IRS is the data mainstay for India, accounting for over 72 percent of the data requests by users, followed by Landsat at 18 percent and SPOT around 6 percent.<sup>43</sup>

India's remote sensing program centers on use of the Indian Satellite (INSAT) series, two Bhaskara spacecraft, the Rohini satellites, and the Indian Remote

<sup>39</sup> Soyuzkarta. Foreign Trade Association, Kartex, Moscow. Sovero No. 28 1/88.

<sup>40</sup> Buyer's Guide Almaz Radar Remote Sensing Satellite. Space Commerce Corporation, Houston, Texas; William B. Wirin, "New Vision from Space: ALMAZ," *Aerospace & Defense Science*, October/November 1990, pp. 19-22, William B. Wirin, *Almaz: Looking Through Clouds*, presented at 11th Symposium EARSel, Graz, Austria, July 3-5, 1991.

<sup>41</sup> "Hughes STX Signs Agreement on Data from Russian Satellite," *The Washington Post*, Mar. 2, 1992, p. 7.

<sup>42</sup> Daniel J. Marcus, "Almaz Team Fears Shutdown Without More Foreign Sales," *Space News*, vol. 3, No. 3, Jan. 27-Feb. 2, 1992, p. 23.

<sup>43</sup> *Inventory of Remote Sensing Facilities and Activities in the ESCAP Region*, United Nations Inventory Report: India, December 1990.

Sensing satellite series: IRS-1A and IRS-1B, Along with the development of these spacecraft, India has pursued an independent launch capability, although U. S., Soviet, and European boosters have also been utilized to launch Indian satellites.

#### Bhaskara

The Bhaskara series served as experimental spacecraft, launched by Soviet boosters in 1979 and 1981. The Bhaskara spacecraft were each placed in a roughly 400-mile-high Earth orbit. Both satellites carried slow scan vidicon equipment and passive microwave radiometers. The satellite's vidicon equipment operated in 0.54-0.66 micron and 0.75-0.85 micron spectral channels, and produced images for land use, snow cover, coastal processes, and for forestry purposes. The radiometers operated in the 19, 22, and 31 GHz range and collected data on sea surface phenomena, water vapor and liquid water content.

#### Rohini

The Rohini series began with Rohini-1 launched into Earth orbit in July 1980, using India's national booster, the SLV-3, While the initial Rohini was apparently used to measure rocket performance, Rohini-2, orbited in May 1981, carried remote sensing equipment but operated for only 9 days. Rohini-3 was orbited in April 1983 and also carried equipment for "remote sensing" purposes. Material provided by ISRO for this assessment contains no mention of the Rohini series. Western officials have claimed these satellites are designed to assist in the creation of an Indian military reconnaissance capability.

#### INSAT

The Indian National Satellite system combines both Earth observation and domestic communications functions. The INSAT spacecraft built to date have been of American design, purchased by India from Ford Aerospace. The INSAT-1A was launched in April 1982 by a U.S. Delta rocket, but suffered problems during deployment of spacecraft hardware. An INSAT 1B was subsequently launched using a U.S. Space Shuttle in August 1983. INSAT 1C was launched by an Ariane booster in July 1988, and an INSAT 1D was rocketed into orbit by a commercial U.S. Delta in June 1990.

INSAT remote sensing activities center on using a two-channel Very High Resolution Radiometer (VHRR)

that yields 0.55-0.75 micron visible and 10.5-12.5 micron infrared images of the Earth. From their geostationary altitude, INSAT spacecraft produce imagery every 30 minutes. INSAT-series spacecraft have a design life of some ten years. In addition to imagery, the INSAT satellites relay data collected from some 100 hydrological, oceanographic, and meteorological ground stations.

INSAT-2 is under development, and will be constructed by ISRO and Indian companies and launched by an Ariane booster. Similar in capabilities to previous INSATS, the INSAT-2 is expected to yield higher VHRR resolution in the 2 km visible and 8 km infrared. A series of two INSAT-2 test spacecraft and three additional operational satellites is now being planned.

#### Indian Remote Sensing Satellite (IRS)

As India's first domestic dedicated Earth resources satellite program, the IRS series provides continuous coverage of the country, with an indigenous ground system network handling data reception, data processing and data dissemination. India's National Natural Resources Management System uses IRS data for many projects.

To date, two IRS satellites have been launched: IRS-1A in March 1988 by a Russian launcher; and IRS-1 B in August 1991, also launched by a Russian booster, Both IRS spacecraft carry identical onboard hardware.

IRS-1A and IRS-1B are the backbone of India's Natural Resources Management System; both are in 904-km polar sun-synchronous orbit. Each carries two payloads employing Linear Imaging Self-scanning Sensors (LISS), which operate in a pushbroom scanning mode using CCD linear arrays. The IRS satellites have a 22-day repeat cycle. The LISS-I imaging sensor system constitutes a camera operating in four spectral bands compatible with the output from Landsat-series Thematic Mapper and SPOT HRV instruments (table D-1), Geometric resolution of the LISS-I is 72 meters at a swath of 148 km. The LISS-IIA and B are comprised of two cameras operating in 0.45 to 0.86 microns with a ground resolution of 36.5 meters, each with a swath of 74 km. The two units are located on either side of the LISS-I and view either side of the ground track with a 3-km lateral overlap.

Data products from the IRS can be transmitted in real time, or by way of tape recorder. As part of the National Remote Sensing Agency's international services, IRS data are available to all countries which are within the coverage zone of the Indian ground station located at Hyderabad: Afghanistan, Bahrain, Bangladesh, Bhutan, Burma, Cambodia, China, Indonesia, Iran, Laos, Malaysia, Maldives, Mali, Nepal, Oman, Pakistan, Qatar, Saudi Arabia, Singapore, Socotra, Somalia, Sri Lanka, Thailand, United Arab Emirates, the CIS (former USSR), Vietnam, and Yemen. These countries can receive the raw/processed data directly from the NRSA Data Center.

#### IRS Follow-on Series

Second-generation IRS-1 C and 1D satellites are being designed to incorporate sensors with resolutions of about 20 meters in multispectral bands and better than 10 meters in the panchromatic band apart from stereo viewing, revisit and onboard data recording capabilities. ISRO is planning to add a band in Short Wave IR (SWIR) at a spatial resolution of 70 meters. In addition, a Wide Field Sensor (WiFS) with 180 meters spatial resolution and a larger swath of about 770 km is planned for monitoring vegetation.

India expects to launch IRS-1 C sometime in 1994, while IRS-1 D will be launched in 1995 or 1996. An IRS-series spacecraft capable of microwave remote sensing—similar to Europe's ERS-1—is also under consideration for launching in the late '90s.

#### Ground Facilities

IRS data are regularly acquired at the National Remote Sensing Agency (NRSA) Earth station at Shadnagar, Hyderabad. Five regional remote sensing service centers have been established to provide users digital analysis and interpretation of IRS data and other remotely sensed satellite information. The centers are located at Bangalore, Dehra Dun, Jodhpur, Nagpur and Kharagpur. Also, state remote sensing centers in all 21 states have been established to carry out projects of

direct relevance to the states and/or participate in national programs.

The use of low-cost PC-based digital image processing systems have permitted widespread applications of remote sensing data throughout India. IRS data have been used to monitor drought, map saline/alkaline soils, estimate large area crop production, and inventory urban sprawl of all cities with populations greater than one million.

### CHINA

China's remote sensing activities have been tied to satellite communications and geographic information systems designed to alert the government of environmental situations, such as impending flood conditions and to estimate disaster damage.<sup>44</sup> Capable of launching its own satellites with its Long March boosters, China's remote sensing work centers around the Feng Yun (FY) satellite series to gather meteorological data,<sup>45</sup> while China's FSW (see below) recoverable satellites have returned film of remotely sensed scenes to Earth-usable for commercial and military purposes.<sup>46</sup> In December 1986, the Chinese inaugurated operational use of a Landsat receiving station, purchased from the United States. China pays a \$600,000 annual access fee to EOSAT to use the Landsat ground terminal.<sup>47</sup> China can market the data without restriction. The station is positioned at Miyun, northeast of Beijing, with processing facilities situated northwest of Beijing. Lastly, China and Brazil are cooperating on the Earth Resources Satellite system comprised of two spacecraft and several Earth stations.

#### Feng Yun (FY)

The Feng Yun (FY) "Wind and Cloud" satellites are built for meteorological purposes, to monitor conditions of China's vast territory and coastline. Two of the FY series have been launched since September 1988.

While China can obtain realtime cloud NOAA/TIROS-N data, this information is not in the three-dimensional

<sup>44</sup> C. Fang-yun, Tong Kai, and Yang Jia-chi, "The Proposal About Constructing the National Disaster Monitoring, Forecast and Control System," presented at 42d Congress of the International Astronautical Federation, (IAF-91-113), Montreal, Canada, Oct. 5-11, 1991.

<sup>45</sup> M. Zhizhong, and Xu Fuxiang, "Chinese Meteorological Satellites and Technical Experiment of the Satellites," presented at 42d Congress of the International Astronautical Federation (IAF-91-017), Montreal, Canada, Oct. 5-11, 1991.

<sup>46</sup> Recoverable Satellite—FSW—Micogravity Test Platform, Chinese Academy of Space Technology, Beijing, China.

<sup>47</sup> Marcia Smith, *Space Commercialization in China and Japan*, CRS Report for Congress, (88-519 SPR), Congressional Research Service, Washington, DC, July 28, 1988, pp. 8-9.

format needed for medium and long-range weather forecasting, numerical forecasting, and climate research. Similarly, China has access to data from the Japanese geostationary meteorological satellite but this satellite is positioned to the east of China, seriously distorting cloud imagery of the vast western part of China. Therefore, beginning in the 1970s, China started its own polar-orbiting meteorological satellite program, followed in the mid-1980s with plans to develop a geostationary meteorological satellite.

The FY-1 had a one-year design lifetime, but failed after 39 days. During its life, China's first experimental weather satellite relayed high-quality imagery to Earth. While four visible channels from the satellite broadcast successfully, signals from the infrared channel were poor, apparently as a result of contamination of the infrared sensing hardware at the launch site. An attitude control failure shortened the mission of the satellite.

The FY-1 made 14 cycles per day (seven passes per day over Chinese territory) in a near polar sun-synchronous orbit with an altitude of 900 km. Part of its instrument package contained two scanning five-channel Advanced Very High Resolution Radiometers (AVHRRS), four in the visible spectrum and one in infrared (table D-1). Day and night cloud images were acquired, permitting measurements of sea surface state and silt and chlorophyll concentrations in brine.

Use of C band frequency permitted the FY-1 to incorporate a High Resolution Picture Transmission system in a data format the same as that of the NOAA/TIROS-N and with a ground resolution of 1.1 km. Also, an APT transmitter sent realtime cloud images with a resolution of 4 km.

Hardware changes were made in the design of FY-1 B, orbited in September 1990. Further refinement of the FY-1 class satellite, according to some sources, suggest China may launch an FY-1 C and FY-1D satellite, then embody that technical expertise into a fully modified FY-1 satellite.

At present, the development of FY-2A is underway, with a launch set for the mid-1990s. This satellite will be placed in geostationary orbit over China and is to provide almost instantaneous weather/climate data

collection over every region of China and Asia, as well as most parts of Oceania.

#### Fanhui Shi Weixing (FSW) Recoverable Satellite

The Chinese FSW commercial platform series is capable of carrying various kinds of equipment into orbit, including remote sensing hardware. Presently, an FSW-I and larger FSW-II platform are being made available by the Chinese Academy of Space Technology. These are geared primarily for microgravity research purposes. The FSW-I recoverable satellite can remain in orbit for 5 to 8 days and is replete with telemetry for realtime data transmission, or tape recorders for data storage. Recoverable payloads of 20 kg are possible. For the FSW-II, recoverable payload weight of 150 kg is possible, with the satellite able to remain in orbit for 10 to 15 days. The price for use of an FSW recoverable satellite has been reported to be \$30,000 to \$50,000 per kilogram.

The FSW is similar to the satellite recovery concept used in the U.S. Air Force Discovery program of the late 1950s and early 1960s. Previous FSW returnable capsules have reportedly been used for capturing high-quality imagery for military reconnaissance purposes.

#### China-Brazil Earth Resources Satellite (CBERS)

Initiated by an agreement signed July 6, 1988, China and Brazil have jointly pursued a cooperative project to build two remote sensing satellites, each capable of SPOT-like performance using linear CCDs.<sup>48</sup> The CBERS-1 and CBERS-2 would be designed by the Xian Research Institute of Radio Technology, which would also supply the imaging system. Brazil's Institute of Space Research (INPE), near Sao Paulo, would be responsible for satellite structure, power supply, data collection system and other items.

China would take on the larger financial stake for the CBERS satellites-70 percent to Brazil's 30 percent. In U.S. dollars this percentage split represents an investment of \$105 million, with Brazil spending \$45 million.

Prior to the first CBERS launching, Satellite de Coleta de Dados 1 (SCD-1) was orbited in 1992. This first Brazilian-made satellite is an environmental data collection satellite to be followed by an SCD-2 launch

<sup>48</sup> *China-Brazil Earth Resources Satellite-CBERS*, Instituto de Pesquisas Espaciais, Sao Jose dos Campos, Brazil. [no date]

in 1993. Each will be placed in 750-km orbits. Two Sensoriamento Remoto (SSR) satellites are also to be launched, in 1995 and in 1996, respectively. Carrying CCD cameras capable of 200-meter resolution, the SSR-1 and SSR-2 are to be placed in 642-km, sun-synchronous orbits.

The CBERS project completed its phase B work in 1989, when the preliminary design of the satellite was completed. The project is currently in the development and engineering phase with some contracts with Brazilian industries established. Because of budget difficulties, work on the project has been slowed.

Launch of the CBERS-1 appears now to be planned for 1995, with the satellite placed in a 778-km sun-synchronous orbit. CBERS-2 launch is targeted for 1996. The CBERS five-channel linear CCD would provide visible and panchromatic coverage. Spectral bands would range from 0.51 microns to 0.89 microns. Ground resolution of the CCD camera is 20 meters. A CBERS infrared multispectral scanner would include four channels between 0.5 and 12.5 microns. The infrared multispectral scanner would yield an 80-meter ground resolution, CBERS imagery is designed to rival SPOT and Landsat data. China's Great Wall Industry Corp. and Brazil's Avibras Aeroespacial in 1989 signed a joint venture agreement to establish INSCOM, a company that would specialize in establishing a ground data handling network. Like China, Brazil has a Landsat ground station, operating a facility since 1973. A data processing center was established there the following year.

## INTERNATIONAL COOPERATION IN REMOTE SENSING

Global climate change knows no national borders. Satellite observations of the Earth, therefore, must in time become a truly international activity. A myriad of organizations now play key roles in the attempt to coordinate the scientific study of Earth's biosphere. These include groups from the national and interna-

tional scientific community; government agencies; and intergovernmental science bodies.<sup>49</sup>

### Key Organizations

The International Council of Scientific Unions (ICSU)--created in 1931 as an autonomous federation consisting of 20 disciplinary scientific unions and 70 national member organizations---has endorsed and runs the International Geosphere-Biosphere Program (IGBP) to help determine the interactive physical, chemical and biological processes that regulate the total Earth system, including the influences of human actions on those processes.

The IGBP, in turn, involves the United Nations (UN) World Meteorological Organization (WMO), the United Nations Educational, Scientific, and Cultural Organization (UNESCO), and the United Nations Environment Program (UNEP), which, in turn, is coordinating the World Climate Research Program (WCRP).

In 1988, the UN established the Intergovernmental Panel on Climate Change (IPCC), sponsored jointly by the WMO and the UNEP. The IPCC serves as a primary international forum for addressing climate change, with three working groups that: assess scientific evidence on climate change; assess likely impacts resulting from such change; and consider possible response strategies for limiting or adapting to climate change.

As a member of ICSU, the National Academy of Sciences' National Research Council (NRC) participates in the IGBP through its Committee on Global Change (CGC), which is reviewing the U.S. Global Change Research Program (USGCRP). Another NRC entity, the Committee on Earth Studies (CES), is providing the federal government with advice on the study of the Earth from space.

Remote sensing for environmental monitoring cuts across territory, airspace and economic zones of the Earth's nation states, where the systematic exchange of data or joint access will necessitate international

<sup>49</sup> Marcia S. Smith, and John R. Justus, *Mission to Planet Earth and the U.S. Global Change Research Program*, CRS Report for Congress, Congressional Research Service, 90-300 SPR, June 19, 1990; James D. Baker, "Observing Global Change from Space: Science & Technology," presented at Annual Meeting of the American Association for the Advancement of Science, Washington, DC, February 1991; *Climate Change: The IPCC Scientific Assessment*, J.T. Houghton, G.J. Jenkins and J.J. Ephraums, eds., Cambridge University Press, Cambridge, MA, 1990, pp. 315-328; *Assessment of Satellite Earth Observation Programs-1991*, Committee on Earth Studies, Space Studies Board, Commission on Physical Sciences, Mathematics, and Applications, National Research Council, Washington, DC, 1991; and Congress of the United States, Office of Technology Assessment, *Changing By Degrees: Steps to Reduce Greenhouse Gases* (OTA-OE-O-482, Washington DC: U.S. Government Printing Office, February 1991), pp. 282-283.



agreement. Compatibility among observation systems, data exchanges, and the setting of data product standards is key to establishing a meaningful and unified global research program of Earth observation.

A recent example of this is exploratory discussions between the European Space Agency (ESA) and the Japanese Minister for Science and Technology, who also chairs Japan's Space Activities Commission.<sup>50</sup> Both parties agreed to study the prospects for wider cooperation between ESA and Japan on observations of the Earth and its environment, using next-generation meteorological satellites. In addition, ESA and Japan will study the relay of data by European and Japanese data relay satellites.

The following paragraphs summarize the work of three organizations that are attempting to coordinate data gathered globally, or are wrestling with the policy issues attendant to the acquisition and interpretation of remote sensing information.

#### Consortium for International Earth Science Information Network (CIESIN)

The U.S. Congress, on Oct. 18, 1989, mandated through Public Law No. 101-144 an effort to "integrate and facilitate the use of information from government-wide Earth monitoring systems" for understanding global change. The law stipulated that NASA should take the lead in broadening the work now planned for the Earth Observing System "to create a network and the required associated facilities to integrate and facilitate the use of information from government-wide Earth monitoring systems. CIESIN was chartered in October 1989 as a nonprofit corporation in the State of Michigan to accomplish this. The founding members are the Environmental Research Institute of Michigan (ERIM), Michigan State University, Saginaw Valley State University, and the University of Michigan.<sup>51</sup> CIESIN membership has been expanded to include New York Polytechnic Institute, and the University of California.

**According to CIESIN, the organizational mix brings expertise in the fields of the natural Earth sciences, remote sensing and its international applications, public policy, the social sciences, electronic networking, media, and education. The group has been**

established to enable scientists and policymakers to model, predict, and understand global change on an international scale. CIESIN has embarked on networking global change resources as an early priority.

#### Committee on Earth Observation Satellites

The Committee on Earth Observation Satellites (CEOS) was created in 1984 as a result of recommendations from the Economic Summit of Industrialized Nations. Members of CEOS are government agencies with funding and program responsibilities for satellite observations and data management. The United Kingdom served as CEOS secretariat in 1992. Japan will host the CEOS plenary in 1993, followed by Germany in 1994.

At the CEOS plenary level, agencies are represented by the head of the agency or Earth observation division: NOAA and NASA for the U. S., ASI (Wily), BNSC (UK), CNES (France), CSA (Canada), CSIRO (Australia), DARA (Germany), ESA (Europe), Eumetsat (Europe), INPE (Brazil), ISRO (India), STA (Japan), and the Swedish National Space Board.

Governmental bodies with a space-based Earth observation program in the early stages of development or with significant ground segment activities that support CEOS member agency programs may qualify for observer status. Current observers are agencies from Canada, New Zealand, and Norway.

CEOS members intend for the organization to serve as *the* focal point for international coordination of space-related Earth observation activities, including those related to global change. Policy and technical issues of common interest related to the whole spectrum of Earth observations satellite missions and data received from such are to be addressed by CEOS.

CEOS has been successful in interacting with both international scientific programs—ICSU/IGBP, WCRP—as well as intergovernmental user organizations—IPCC, WMO, the Intergovernmental Oceanographic Commission (IOC), the United Nations Environmental Program (UNEP)—in order to enhance and further focus space agency Earth observation mission planning on global change requirements.

<sup>50</sup>"ESA and Japan Meet on Space Cooperation" *ESA News Release, No. 12, European Space Agency, Paris, France, March 11, 1992.*

<sup>51</sup>"Information for a Changing World—Strategies for Integration and Use of Global Change Information," *Executive Summary* of a Report to Congress, Consortium for International Earth Science Information Network (CIESIN), May 15, 1991.

#### Space Agency Forum on ISY (SAFISY)

The International Space Year (ISY) of 1992 promulgated the establishment in 1988 of SAFISY, a coordination group of the world space agencies.<sup>52</sup> SAFISY provided a mechanism, through periodic meetings, for the agencies to share ideas and pool resources in connection with the International Space Year.

Panels of experts were established by SAFISY, two of which are scientific in nature, The Panel of Experts on Earth Science and Technology monitored projects that are designed to provide worldwide assessment of threats to the environment through satellite observa-

tions and the development of predictive models. The Panel of Experts on Space Science monitored projects under the theme ‘Perspectives from Space,’ emphasizing that unlimited perspectives are gained through all aspects of space science study and through venturing out into space.

A third SAFISY panel, Panel of Experts on Education and Applications, was geared to promote ISY educational activities internationally, many of which deal with satellite remote sensing.

---

<sup>52</sup> Space Agency Forum on the International Space Year-Third Meeting (SAFISY-3), NASDA CM-147, Kyoto, Japan, May 17-18, 1990.

# Appendix E: Glossary of Acronyms

AATSR	—Advanced Along-Track Scanning Radiometer	AVIRIS	—Airborne Visible Infrared Imaging Spectrometer
ACR	—Active Cavity Radiometer	AVNIR	—Advanced Visible and Near-Infrared Radiometer
ACRIM	—Active Cavity Radiometer Ix-radiance Monitor	CCD	—Charged Coupled Device
ADEOS	—Advanced Earth Observing Satellite	CCRS	—Canada Centre for Remote Sensing
AES	—Atmospheric Environment Service	CEES	—Committee on Earth and Environmental Sciences
AIRS	—Atmospheric Infrared Sounder	CEOS	—Committee on Earth Observations Satellites
ALEXIS	—Array of Low Energy X-Ray Imaging Sensors	CERES	—Clouds and Earth’s Radiant Energy System
ALT	—Altimeter	CES	—Committee on Earth Studies
AMS	—American Meteorological Society	CFC	—Chlorofluorocarbon
AMSR	—Advanced Microwave Scanning Radiometer	CGC	—Committee on Global Change
<b>AMSU</b>	—Advanced Microwave Sounding Unit	CIESIN	—Consortium for International Earth Science Information Network
AMTS	—Advanced Moisture and Temperature Sounder	CLAES	—Cryogenic Limb Array Etalon Spectrometer
APT	—Automatic Picture Transmission	CNES	—Centre National d’Etudes Spatiales
ARA	—Atmospheric Radiation Analysis	CNRS	—Centre National de la Recherche Scientifique
ARGOS	—Argos Data Collection and Position Location System	COSPAR	—Congress for Space Research
ARM	—Atmospheric Radiation Measurement	CPP	—Cloud Photopolarimeter
ASAR	—Advanced Synthetic Aperture Radar	CSA	—Canadian Space Agency
ASCAT	—Advanced Scatterometer	CZCS	—Coastal Zone Color Scanner
ASF	—Alaska SAR Facility	DAAC	—Distributed Active Archive Center
ASTER	—Advanced Spaceborne Thermal Emission and Reflection Radiometer	DB	—Direct Broadcast
ATLAS	—Atmospheric Laboratory for Applications and Science	DCS	—Data Collection System
ATMOS	—Atmospheric Trace Molecules Observed by Spectroscopy	DDL	—Direct Downlink
AVHRR	—Advanced Very High Resolution Radiometer	DMSP	—Defense Meteorological Satellite Program
		DOC	—Department of Commerce

DOD	—Department of Defense	GEWEX	—Global Energy and Water Cycle Experiment
DOE	—Department of Energy	GGI	—GPS Geoscience Instrument
DOI	—Department of the Interior	GLAS	—Geoscience Laser Altimeter System
<b>DORIS</b>	—Doppler Orbitography and Radiopositioning Integrated by Satellite	GLI	—Global Imager
<b>DOS</b>	—Department of State	GLRS	—Geoscience Laser Ranging System
DPT	—Direct Playback Transmission	GMS	—Geostationary Meteorological Satellite
DRSS	—Data Relay Satellite System	GOES	—Geostationary Operational Environmental Satellite
EC	—European Community	GOMI	—Global Ozone Monitoring Instrument
<b>EDC</b>	—EROS Data Center	GOMOS	—Global Ozone Monitoring by Occultation of Stars
EDRTS	—Experimental Data Relay and Tracking Satellite	GOMR	—Global Ozone Monitoring Radiometer
EOC	—EOS Operations Center	GOMS	—Geostationary Operational Meteorological Satellite
EOS	—Earth Observing System	GPS	—Global Positioning System
EOS-AERO	—EOS Aerosol Mission	HIRDLS	—High-Resolution Dynamics Limb Sounder
EOS-ALT	—EOS Altimetry Mission	HIRIS	—High-Resolution Imaging Spectrometer
EOS-AM	—EOS Morning Crossing (Ascending) Mission	HIRS	—High-Resolution Infrared Sounder
EOSAT	—Earth Observation Satellite company	HIS	—High-Resolution Interferometer Sounder
EOS-CHEM	—EOS Chemistry Mission	<b>HRPT</b>	—High-Resolution Picture Transmission
EOSDIS	—EOS Data and Information System	HYDICE	—Hyperspectral Digital Imagery Collection Experiment
EOSP	—Earth Observing Seaming Polarimeter	ICSU	—International Council of Scientific Unions
EOS-PM	—EOS Afternoon Crossing (Descending) Mission	IGBP	—International Geosphere-Biosphere program
EPA	—Environmental Protection Agency	ILAS	—Improved Limb Atmospheric Spectrometer
ERBE	—Earth Radiation Budget Experiment	INSAT	—Indian National Satellite
ERBS	—Earth Radiation Budget Satellite	IMG	—Interferometric Monitor for Greenhouse Gases
EROS	—Earth Resources Observation System	<b>IPCC</b>	—Intergovernmental Panel on Climate Change
<b>ERS</b>	—European Remote-Sensing Satellite	<b>IRS</b>	—Indian Remote Sensing Satellite
ERTS-1	—Earth Resources Technology Satellite-1	IRTS	—Infrared Temperature Sounder
ESA	—European Space Agency	ISAMS	—Improved Stratospheric and Mesospheric Sounder
ESDIS	—Earth Science Data and Information System	ISY	—International Space Year
EWUN	—European Scientific Research Institute	<b>JERS</b>	—Japan Earth Resources Satellite
ETS-VI	—Engineering Test Satellite-VI	JOES	—Japanese Earth Observing System
E UMETSAT	—European Organization for the Exploitation of Meteorological Satellites	JPL	—Jet Propulsion Laboratory
FCCSET	—Federal Coordinating Council for Science, Engineering, and Technology	JPOP	—Japanese Polar Orbiting Platform
FOV	—Field-of-View	LAGEOS	—Laser Geodynamics Satellite
FST	—Field Support Terminal		
FY	—Feng Yun		
GCDIS	—Global Change Data and Information System		
Geosat	—Navy Geodetic Satellite		

Landsat	—Land Remote-Sensing Satellite	<b>OMB</b>	—Office of Management and Budget
Lidar	—Light Detection and Ranging	OPS	—Optical Sensors
LIMS	—Limb Infrared Monitor of the Stratosphere	OSC	—Orbital Sciences Corporation
LIS	—Lightning Imaging Sensor	<b>OSIP</b>	—operational Satellite Improvement Program
LISS	—Linear Imaging Self-scanning Sensors	POEM	—Polar-Orbit Earth Observation Mission
LITE	—Lidar In-Space Technology Experiment	POES	—Polar-orbiting Operational Environmental Satellite
LR	—Laser Retroreflector	POLDER	—Polarization and Directionality of Earth's Reflectance
MERIS	—Medium-Resolution Imaging Spectrometer	RA	—Radar Altimeter
MESSR	—Multispectrum Electronic Self-Scanning Radiometer	Radarsat	—Radar Satellite
METOP	—Meteorological Operational Satellite	<b>RESTEC</b>	—Remote Sensing Technology Center
MHS	—Microwave Humidity Sounder	<b>RF</b>	—Radio Frequency
<b>MIMR</b>	—Multifrequency Imaging Microwave Radiometer	<b>RIS</b>	—Retroreflector in Space
MIPAS	—Michelson Interferometer for Passive Atmospheric Sounding	<b>SAFIRE</b>	—Spectroscopy of the Atmosphere using Far Infrared Emission
MISR	—Multi-Angle Imaging SpectroRadiometer	<b>SAFISY</b>	—Space Agency Forum on ISY
<b>MLS</b>	—Microwave Limb Sounder	SAGE	—Stratospheric Aerosol and Gas Experiment
MODIS	—Moderate-Resolution Imaging Spectroradiometer	SAMS	—Stratospheric and Mesospheric Sounder
MOP	—Meteosat Operational Programme	SAR	—Synthetic Aperture Radar
MOPITT	—Measurements of Pollution in the Troposphere	SARSAT or S&R	—Search and Rescue Satellite Aided Tracking System
MOS	—Marine Observation Satellite	SBUV	—Solar Backscatter Ultraviolet Radiometer
MSR	—Microwave Scanning Radiometer	SCARAB	—Scanner for the Radiation Budget
MSS	—Multispectral Scanner	SeaWiFS	—Sea-Viewing Wide Field Sensor
MSU	—Microwave Sounding Unit	SEDAC	—Socio Economic Data Archive Center
MTPE	—Mission to Planet Earth	SEM	—Space Environment Monitor
MTS	—Microwave Temperature Sounder	S-GCOS	—Space-based Global Change Observation System
NASA	—National Aeronautics and Space Administration	SIR-C	—Shuttle Imaging Radar-C
NASDA	—National Space Development Agency (Japan)	SLR	—Satellite Laser Ranging
NESDIS	—National Environmental Satellite, Data, and Information Service	SMMR	—Scanning Multispectral Microwave Radiometer
NOAA	—National Oceanic and Atmospheric Administration	SOLSTICE	—Solar Stellar Irradiance Comparison Experiment
NREN	—National Research and Education Network	SPOT	—System Probatoire d'Observation de la Terre
NRSA	—National Remote Sensing Agency	SSM/I	—Special Sensor Microwave/Imager
NSCAT	—NASA Scatterometer	<b>SSU</b>	—Stratospheric Sounding Unit
NSPD	—National Space Policy Directive	STIKSCAT	—Stick Scatterometer
OCTS	—Ocean Color and Temperature Scanner		
OLS	—Optical Line Scanner		

## 192 | Remote Sensing From Space

<b>SWIR</b>	—Short Wave Infrared	<b>USDA</b>	—U.S. Department of Agriculture
<b>TDRSS</b>	—Tracking and Data Relay Satellite System	<b>USGCRP</b>	—U.S. Global Change Research Program
<b>TIROS</b>	—Television Infrared Observing Satellites	<b>USGS</b>	—U.S. Geological Survey
<b>TM</b>	—Thematic Mapper	<b>VHRR</b>	—Very High Resolution Radiometer
<b>TOMS</b>	—Total Ozone Mapping Spectrometer	<b>VISSR</b>	—Visible and Infrared Spin Scan Radiometer
<b>TOGA</b>	—Tropical Ocean Global Atmosphere	<b>VTIR</b>	—Visible and Thermal Infrared Radiometer
<b>TOPEX</b>	—Ocean Topography Experiment	<b>WCRP</b>	—World Climate Research program
<b>TRMM</b>	—Tropical Rainfall Measuring Mission	<b>WEU</b>	—Western European Union
<b>TUSK</b>	—Tethered Upper Stage Knob	<b>WMO</b>	—The U.N. World Meteorological Organization
<b>UARS</b>	—Upper Atmosphere Research Satellite	<b>WOCE</b>	—World Ocean Circulation Experiment
<b>UAWS</b>	—Unpiloted Air Vehicles	<b>X-SAR</b>	—X-Band Synthetic Aperture Radar
<b>UNEP</b>	—United Nations Environment Program		
<b>UNESCO</b>	—United Nations Educational, Scientific, and Cultural Organization		

# Index

- ACRIM. See Active Cavity Radiometer Irradiance Monitor
- Active Cavity Radiometer L-radiance Monitor  
description, 69, 134  
EOS-Chem, 107
- ADEOS. See Advanced Earth Observation Satellite
- Administration Landsat Management Plan, 48,50
- Advanced Earth Observation Satellite, 24, 177-178
- Advanced Microwave Sounding Unit  
EOS-PM, 107  
METOP platform, 41
- Advanced Research Projects Agency  
CAMEO program, 75  
space technology initiatives, 138-139
- Advanced Spaceborne Thermal Emission and Reflection  
radiometer, 106
- Advanced Technology Demonstrations, 75, 138-139
- Advanced Technology Standard Satellite Bus, 75, 138
- Advanced Very High Resolution Radiometer  
AVHRR/2, 40  
METOP platform, 41  
research cooperation between NASA and NOAA, 36
- Advanced Visible and Near Infrared Radiometer, 177-178
- Air Force Space Command, 15
- Aircraft, piloted and unpiloted, 78-79, 124-128
- AIRS. See Atmospheric Infrared Sounder
- Almaz, 61, 181
- Altimeters  
description, 6  
ocean remote sensing, 56, 57
- AMSU. See Advanced Microwave Sounding Unit
- APT. See Automatic Picture Transmission recorders
- ARGOS Data Collection System, 40
- ARM. See Atmospheric Radiation Measurement program
- Arms control monitoring, 82, 161-162, 163
- ARPA. See Advanced Research Projects Agency
- ASTER. See Advanced Spaceborne Thermal Emission and  
Reflection radiometer
- ATDs. See Advanced Technology Demonstrations
- Atmospheric Infrared Sounder, 37, 107
- Atmospheric Radiation Measurement program, 70
- ATSSB. See Advanced Technology Standard Satellite Bus
- Aurora Flight Services, Inc., 79
- Automatic Picture Transmission recorders, 39
- AVHRR. See Advanced Very High Resolution Radiometer
- AVNIR. See Advanced Visible and Near Infrared  
Radiometer
- Balloons, 78-79
- Bhaskara series, 181
- Broad area search, 155-158
- Bromley, D. Allan, 100
- Budgets  
costs of remote sensing, 24-25  
DoD's remote sensing systems, 18  
global change research program, 13  
NASA's remote sensing systems, 18-23  
NOAA's remote sensing systems, 18, 23-24  
reduction of NASA's Earth Observing System program,  
17-18,65-68
- CAMEO. See Collaboration on Advanced Multispectral  
Earth Observation
- Camouflage, Concealment, and Deception, 162-163
- Canada, remote sensing satellite, 57
- CBERS. See China-Brazil Earth Resources Satellite
- CC&D. See Camouflage, Concealment, and Deception
- CEES. See Committee on Earth and Environmental Science
- Centre Nationale d'Etudes Spatiale, 52-53
- CEOS. See Committee on Earth Observations Systems
- CERES. See Clouds and Earth's Radiant Energy System
- China, satellite programs, 183-185
- China-Brazil Earth Resources Satellite, 184-185

## 194 | Remote Sensing From Space

- CIESIN, See Consortium for International Earth Science Information Network
- CIS. See Commonwealth of Independent States
- Civilian space program
  - future of, 11-13
  - market motives, 164
  - military use, 81-84, 145-164
  - satellite characteristics, 148-154
- Climate change. See *also* Global change
  - current state of research, 96-100
  - geostationary satellite system, 34-37
  - human influence, 113
  - meteorological satellite system, 4244
  - non-U.S. environmental satellite systems, 44-45
  - observations of satellite sensors, 33-34
  - polar-orbiting satellite system, 37-43
- Climate feedbacks, 76, 112
- Climate forcings, 76, 112-113
- Climsat, 76-77, 131-135
- Clinton administration, NASA budget request, 20
- Clouds and Earth's Radiant Energy System, 105, 129-131
- CNES. See Centre Nationale d'Etudes Spatial
- CO<sub>2</sub> change, 132, 133
- Coastal Zone Color Scanner, 55
- Collaboration on Advanced Multispectral Earth Observation, 75, 138
- Combat intelligence, 159-161
- Committee on Earth and Environmental Sciences, 13,63-64
- Committee on Earth Observations Systems, 31,90, 186
- Commonwealth of Independent States
  - earth observation satellite programs, 179-181
  - environmental satellite system, 44-45
- Congressional considerations
  - comparing costs and benefits of global change research, 25-26
  - consolidation of DoD's meteorological system and NOAA's polar-orbiting system, 16,44
  - cost reduction for remote sensing systems, 87-88
  - Earth Observing System funding, 65
  - future of space-based remote sensing, 2-3
  - global change data collection continuity, 27
  - improved calibration sensitivity of NOAA sensors, 14-15
  - international cooperation in remote sensing programs, 71
  - land remote sensing support, 27-28
  - Landsat sensors funding, 50
  - Landsat technology development funding, 52
  - military uses of civilian remote sensing data, 165
  - NASA's funding plans for Mission to Planet Earth, 23, 68-69
  - non-space-based research support, 17
  - planning for development of Landsat 8,52
  - private satellite industry support, 87
  - private sector use of land remote sensing, 28,85-87
  - research cooperation between NASA and NOAA, 36-37
  - small satellite systems support, 75
  - unpiloted air vehicles funding, 79, 128
- Consortium for International Earth Science Information Network, 186
- CZCS. See Coastal Zone Color Scanner
- DAACS. See Distributed Active Archive Centers
- Data gathering, 4
- DCS. See ARGOS Data Collection System
- Defense Meteorological Satellite Program
  - future of, 15-16, 17
  - weather observations, 4244
- Department of Defense
  - collaborative projects with NASA, 70
  - developing a strategic plan for remote sensing, 26-27
  - Landsat program, 48-52
  - meteorological satellite system, 15-16, 42-44
  - remote sensing budget, 18
- Department of Energy, strategic plan for remote sensing, 26-27
- Distributed Active Archive Centers, 73, 103
- DMSP. See Defense Meteorological Satellite Program
- DOD. See Department of Defense
- DOE. See Department of Energy
- Earth Observation-International Coordination Working Group, 31
- Earth Observation Satellite Company, 49, 85
- Earth Observing Scanning Polarimeter
  - Climsat, 133, 135
  - description, 106
- Earth Observing System
  - current state of climate research, 96-100
  - description, 16-18,95-96, 101-107
  - EOS Aero, 106
  - EOS-Alt, 107
  - EOS-AM, 105-106
  - EOS-Chem, 107
  - EOS Color, 106
  - EOS Phase One, 104-105
  - EOS-PM, 106-107
  - global change research, 65-72,73
  - instruments not funded, 116-124
  - program, 71
  - and related systems, 101-104
  - restructured program, 69
  - science and policy priorities, 68
  - technology and the restructured program, 110-124
- Earth Observing System Data and Information System
  - description, 102-104
  - global change research, 65-72,73
  - improving the use of research data, 29-30



- Earth Probe satellites, 67  
 Earth Radiation Budget Experiment, 41, 131  
 Earth Resources Satellite, 57-58, 176-177  
 El Nino, 55,97, 132  
 Electro-optical sensors, 47  
 Enhanced Thematic Mapper, 50-51  
 Environmental change. See Global change  
 ENVISAT platform, 41  
 EO-ICWG. See Earth Observation-International  
     Coordination Working Group  
 EOS. See Earth Observing System  
 EOSAT. See Earth Observation Satellite Company  
 EOSDIS. See Earth Observing System Data and Information  
     System  
 EOSP. See Earth Observing Scanning Polarimeter  
 ERBE. See Earth Radiation Budget Experiment  
 ERS. See European Remote Sensing Satellite  
 ERS-1. See Earth Resources Satellite  
 ESA. See European Space Agency  
 ETM. See Enhanced Thematic Mapper  
 Eumetsat. See European Organization for the Exploitation of  
     Meteorological Satellites  
 Europe  
     coordination of satellite research, 31  
     earth observation satellite programs, 167-175  
 European Organization for the Exploitation of  
     Meteorological Satellites  
     description, 168  
     environmental satellite system, 44  
     loan of Meteosat-3 to U. S., 34-35  
     METOP polar platform, 39,41  
 European Remote Sensing Satellite, 168-173  
 European Space Agency  
     environmental satellite system, 44  
     loan of Meteosat-3 to U. S., 34-35  
     METOP polar platform,41  
     ocean remote sensing satellite, 57-58  
  
 Fanhui Shi Weixing recoverable satellite, 184  
 FCCSET. See Federal Coordinating Council for Science,  
     Engineering, and Technology  
 Federal Coordinating Council for Science, Engineering  
     Sciences, and Technology, 13,63  
 Feng Yun, 183-184  
 Filter wedge, 14  
 Flux divergence, 79-80  
 France  
     land remote sensing system, 52-53, 173-175  
     ocean remote sensing, 58, 175  
 FSW. See Fanhui Shi Weixing recoverable satellite  
 Funding. See Budgets  
 FY. See Feng Yun  
  
 GCMS. See General circulation models  
 General circulation models, 95,96  
 Geodesy satellite  
     description, 61  
     Geosat Follow On, 61  
 Geographic information systems, 85-86  
 Geosat. See Geodesy satellite  
 Geoscience Laser Ranging System and Altimeter, 107  
 Geostationary Meteorological Satellites, 44, 175-176  
 Geostationary Operational Environmental Satellites  
     future of, 14  
     weather observations, 34-37  
 Geostationary Operational Environmental Satellites-Next  
     cost performance, 23  
     description, 35-36  
     development problems, 36, 38-39  
 GIS. See Geographic information systems  
 Global change. See *also* Climate change; Earth Observing  
     System  
     contribution of space-based remote sensing, 13  
     costs, 25, 26  
     data collection continuity, 25-26  
     improving the use of research data, 29-31  
     international cooperation, 89-91  
     operational meteorological satellite systems, 14-15  
     research program budgets, 13  
     U.S. research program, 28-30,63-64  
 Global Change Data and Information System, 29  
 Global Habitability Program, 101  
 Global Positioning System, 83  
     GPS Geoscience Instrument, 107  
 Global **Wa**.rmin g, 98-99  
 GLRS-A. See Geoscience Laser Ranging System and  
     Altimeter  
 GMS. See Geostationary Meteorological Satellites  
 GOES. See Geostationary Operational Environmental  
     Satellites  
 GPS. See Global Positioning System  
 Greenhouse effect, 98-99, 115-116  
 Ground resolution, 81, 148  
  
 Helios, 174-175  
 High Resolution Dynamics Limb Sounder, 107  
 High-Resolution Imaging Spectrometer, 123-124  
 High Resolution Infrared Radiation Sounder, 40  
 High Resolution Multispectral Stereo Imager, 50-51  
 High Resolution Picture Transmission recorders, 39  
 HIRDLS. See High Resolution Dynamics Limb Sounder  
 HIRIS. See High-Resolution Imaging Spectrometer  
 HIRS/2. See High Resolution Infrared Radiation Sounder  
 HRMSI. See High Resolution Multispectral Stereo Imager  
 HRPT. See High Resolution Picture Transmission recorders  
 Hughes STX Corporation, 61

## 196 I Remote Sensing From Space

- Hyperspectral imaging systems, **123-124, 139, 140**
- Ice caps. See Ocean remote sensing
- IEOS. See International Earth Observing System
- IIRS. See Image Interpretability Rating Scale
- ILAS. See Improved Limb Atmospheric Spectrometer
- Image Interpretability Rating Scale, 149
- Imaging radiometer, 6
- IMG. See Interferometric Monitor for Greenhouse Gases
- Improved Limb Atmospheric Spectrometer, 177
- India
  - earth observation satellite program, 181-183
  - ground facilities, 183
  - land remote sensing system, 53
- Indian National Satellite system, 182
- Indian Remote Sensing Satellite
  - description, 53, 182-183
  - follow-on series, 183
- Indian Space Research Organization, 181
- Indications and Warning, 158-159
- Insat. See Indian National Satellite system
- Interferometric Monitor for Greenhouse Gases, 177-178
- Intergovernmental Panel on Climate Change, 65
- International cooperation, 89-93, 186-187
- International Earth Observing System, 90
- IPCC. See Intergovernmental Panel on Climate Change
- IRS. See Indian Remote Sensing Satellite
- ISRO. See Indian Space Research Organization
- I&W. See Indications and Warning
- Japan
  - data distribution, 178-179
  - earth observation satellite program, 175-178
  - environmental satellite system, 44
  - future planning, 178
  - land remote sensing, 53-54
  - ocean remote sensing, 58
- Japan Earth Resources Satellite, 53-54, 176-177
- JERS-1. See Japan Earth Resources Satellite
- Land remote sensing
  - applications, 8, 10
  - description, 47-48
  - France, 52-53, 173-175
  - India, 53
  - Japan, 53-54, 176-177
  - Landsat program, 48-52
  - Russia, 54
- Land Remote Sensing Commercialization Act of 1984, 49
- Land Remote Sensing Policy Act of 1992
  - continuity of data collection and use, 25-26
  - introduction of legislation, 48
  - shift of operational control of Landsat, 27, 48
  - technology development program, 51-52
- Landsat program
  - description, 48, 49
  - developing follow-ons, 140-144
  - future satellites, 51-52
  - Landsat 7, 48, 50-51
  - military uses, 81-84
  - role of private sector, 85-86
  - use of data, 27-28
- Laser Atmospheric Wind Sounder, 116-118
- LAWS. See Laser Atmospheric Wind Sounder
- Lidar altimeter, 6
- Linear Imaging Self-scanning Sensors, 53, 182
- LISS. See Linear Imaging Self-scanning Sensors
- Mapping, Charting, and Geodesy, 82-84
  - description, 147-148
  - use of civilian satellites, 154-155
- Marine Observation Satellite, 58, 176
- MC&G. See Mapping, Charting, and Geodesy
- Measurements of Pollution in the Troposphere, 106
- MESSR. See Multispectral Electronic Self-scanning Radiometer
- Meteor satellites, 179-180
- Meteosat Operational Programme, 167-168
- Meteosat satellites
  - description, 44, 167-168
  - loan to U. S., 34-36
- METOP polar platform, 41
- MHS. See Microwave Humidity Sounder
- Michelson Interferometer, 135
- Microwave Humidity Sounder, 107
- Microwave Imager, 42
- Microwave Limb Sounder, 107
- Microwave Scanning Radiometer, 58
- Microwave Sounding Unit, 40
- Microwave Temperature Sounder, 42
- Microwave Water Vapor Sounder, 42
- Military operations
  - civilian satellite characteristics, 148-154
  - issues for Congress, 165
  - market motives, 164
  - remote sensing missions, 145-148
  - use of civilian satellites, 81, 154-165
- MIMR. See Multifrequency Imaging Microwave Radiometer
- MINT. See Michelson Interferometer
- Mir space station, 181
- MISR. See Multiangle Imaging Spectra-Radiometer
- Mission to Planet Earth
  - budget, 18-23
  - current research efforts, 101
  - description, 16-18
  - global change research, 65-72, 73

- improving the use of research data, 29
- new technology for, 136-137
- ML-S. See Microwave Limb Sounder
- Moderate Resolution Imaging Spectrometer, 105-106
- MODIS. See Moderate Resolution Imaging Spectrometer
- MOP. See Meteosat Operational Programme
- MOPITT. See Measurements of Pollution in the Troposphere
- MOS. See Marine Observation Satellite
- MPIR. See Multispectral Pushbroom Imaging Radiometer
- MSR. See Microwave Scanning Radiometer
- MSU. See Microwave Sounding Unit
- MIT. See Multispectral Thermal Imager
- MTPE. See Mission to Planet Earth
- Multiangle Imaging Spectra-Radiometer, 106
- Multifrequency Imaging Microwave Radiometer, 107
- Muhispectral Electronic Self-scanning Radiometer, 58
- Multispectral Pushbroom Imaging Radiometer, 138
- Multispectral Thermal Imager, 140-141
  
- N-ROSS. See Navy Remote Ocean Sensing Satellite
- NASA. See National Aeronautics and Space Administration
- National Aeronautics and Space Act of 1958, 12
- National Aeronautics and Space Administration
  - cooperative research development with NOAA, 36-39
  - developing a strategic plan for remote sensing, 26-27
  - global change research, 65-72,73
  - global research budget, 13
  - Landsat program, 48-52
  - Mission to Planet Earth, 16-18, 101-107
  - remote sensing budget, 18-23
- National Environmental Satellite, Data, and Information Service, 14, 24
- National Natural Resources Management System, 53
- National Oceanic and Atmospheric Administration
  - data processing coordination with DoD, 42,43-44
  - developing a strategic plan for remote sensing, 26-27
  - environmental earth observations, 14-15
  - the geostationary satellite system, 34-37, 38-39
  - the polar-orbiting satellite system, 37-43
  - remote sensing budget, 18, 23-24
- National Oceanic Satellite System, 56
- National Remote Sensing Agency, 183
- National Space Policy Directive 7,28
- National Weather Service, 14,34
- Navy Remote Ocean Sensing Satellite, 56
- NESDIS. See National Environmental Satellite, Data, and Information Service
- Nimbus 7, 55
- NNRMS. See National Natural Resources Management System
- NOAA. See National Oceanic and Atmospheric Administration
- NOSS. See National Oceanic Satellite System
  
- NRSA. See National Remote Sensing Agency
- NSPD7. See National Space Policy Directive 7
  
- Ocean Color and Temperature Scanner, 177-178
- Ocean remote sensing
  - Canada, 57
  - description, 54-55
  - European Space Agency, 57-58, 168, 172
  - France, 58, 175
  - Japan, 58, 176
  - observations of sea ice, 56-57
  - operational uses of ocean satellites, 56
  - Orbital Sciences Corp., 59,61
  - research of ocean phenomena, 55-56
  - Russia, 61, 180
  - sensor design and selection, 60, 61
  - United States, 61
  - United States/France, 58, 175
- OCTS. See Ocean Color and Temperature Scanner
- Office of Science and Technology Policy, 31
- Okean-0, 180
- OLS. See operational Linescan System
- Operational Linescan System, 42
- Operational Satellite Improvement Program, 36,38
- Orbital Sciences Corporation, 59,61
- OSC. See Orbital Sciences Corporation
- OSIP. See Operational Satellite Improvement Program
- Ozone depletion, 102, 115. See *also* Radiative forcings
  
- Perseus, 79, 127-128
- Platforms
  - role of small satellites, 128
  - satellite v. non-satellite data collection, 124-125
  - unpiloted air vehicles, 125-128
- POEM. See Polar Orbit Earth Observation Mission
- POES. See Polar-orbiting Operational Environmental Satellite
- Polarization and Directionality of the Earth's Reflectance, 177-178
- Polar Orbit Earth Observation Mission, 41
- Polar-orbiting Operational Environmental Satellite
  - future of, 14-15
  - weather observations, 37-43
- POLDER. See Polarization and Directionality of the Earth's Reflectance
- Private sector
  - partnership with government for system development, 92-93
  - role in remote sensing, 85-88
  - use of land remote sensing, 28, 85-88
- Process studies, 79-80
- Pushbroom detectors, 139, 142-143

## 198 I Remote Sensing From Space

- Radar altimeters
  - description, 6
  - ocean remote sensing, 57
- Radarsat, 57
- Radar sensors, 6
- Radiation budget, 8,79, 129-131
- Radiative feedbacks, 76, 112
- Radiative forcings, 76, 112-113
- Radiometers. See *also* Advanced Very High Resolution Radiometer
  - imaging, 6
  - ocean remote sensing, 57
  - polar-orbiting operational environmental satellites, 40,41
- Radiometric resolution, 60
- Radiosondes, 41
- Reagan Administration, NASA funding, 38
- Reconnaissance, 81-82, 146-147
- Remote Sensing Technology Center of Japan, 58, 178-179
- Resolution, role in military detection, 148-151
- RESTEC. See Remote Sensing Technology Center of Japan
- Resurs satellites, 54, 180-181
- Retroreflector in Space, 177
- RIS. See Retroreflector in Space
- Rohini series, 181
- Russia
  - environmental satellite system, 44-45, 179-180
  - land remote sensing, 54, 180-181
  - MIR space station, 181
  - ocean remote sensing, 61, 180-181
  - possible coordination of satellite research, 31
- S-GCOS. See Space-based Global Change Observation System
- SAFISY. See Space Agency Forum on International Space Year
- SAGE III. See Stratospheric Aerosol and Gas Experiment
- Santa Barbara Research Center, 144
- SAR. See Synthetic Aperture Radar
- SARSAT. See Search and Rescue Satellite Aided Tracking System
- Satellite de Coleta de Dados, 184-185
- satellites
  - applications of remote sensing, 6-10
  - benefits of remote sensing, 22,24-25
  - control, 153
  - costs, 24-25, 153, 154
  - current remote sensing systems, 2, 72-73
  - earth monitoring satellites, 3
  - international coordination of research, 31
  - metric, 152
  - military use against U. S., 162-164
  - NOAA's operational meteorological systems, 14-15
  - nonsatellite data, 77-78, 124-125
  - role of private sector, 85-88
  - small systems, 73-76, 128-129
  - spectrum, 151
  - stereoscope, 151-152
  - throughput, 153
  - timeliness, 152-153
  - USE in military operations, 154-162
- SBRC. See Santa Barbara Research Center
- SBUV/2. See Solar Backscatter Ultraviolet Radiometer/2
- Scanning Multichannel Microwave Radiometer, 55
- Scatterometer
  - aboard ADEOS satellite, 24
  - description, 6
  - EOS Phase One, 105
  - NASA, 177-178
  - ocean remote sensing, 56, 57
- SCD. See Satellite de Coleta de Dados
- Sea ice. See Ocean remote sensing
- Sea-viewing Wide Field of view Sensor
  - EOS Color, 106
  - EOS Phase One, 104
  - surface remote sensing, 59, 61
- Search and Rescue Satellite Aided Tracking System, 40
- Seasat, 55-56
- SeaStar satellite, 59,61,87
- SeaWiFS. See Sea-viewing Wide Field of view Sensor
- SEM. See Space Environment Monitor
- Sensoriamento Remoto satellites, 185
- Sensors
  - applications, 6-10
  - design and selection, 60,61
  - developing new systems, 28
  - how **SenSOrS** **Work**, 5-6
  - for land remote sensing, 49-50
  - research cooperation between NASA and NOAA, 36-37
- Shuttle Imaging Radar, 118, 123
- Shuttle orbiters, 22
- SIMS. See Small Imaging Multispectral Spectrometer
- SIR-C. See Shuttle Imaging Radar
- Small Imaging Multispectral Spectrometer, 140
- SMMR. See Scanning Multichannel Microwave Radiometer
- Solar BackScatter Ultraviolet Radiometer/2,40
- Solar radiation, 6,7
- Sounders, 6,37,40
- Space Agency Forum on International Space Year, 187
- Space-based Global Change Observation System, 28-29
- Space Environment Monitor, 40
- Space program
  - applications of remote sensing, 6-10
  - collecting routine earth observations, 27-28
  - developing a strategic plan for remote sensing, 26-27
  - future of civilian program, 11-13
  - global change research, 28-29

- improving the use of data, 29-30
- remote sensing definition, 5
- role of private sector, 85-88
- U.S. space policy, 90
- Spectral resolution, 60, 151
- SPOT. See Systeme Pour d'Observation de la Terre
- S&R. See Search and Rescue Satellite Aided Tracking System
- SSR. See Sensoriamento Remoto satellites
- SSU. See Stratospheric Sounding Unit
- Stratospheric Aerosol and Gas Experiment
  - Climsat, 133, 135
  - EOS Aero, 106
- Stratospheric Sounding Unit, 40
- Surface remote sensing. See *also* Land remote sensing;
  - Ocean remote sensing
    - international cooperative development program, 92
- Synthetic Aperture Radar
  - description, 118-123
  - ocean remote sensing, 56-58, 61
- Systeme Pour d'Observation de la Terre
  - description, 52-53, 173-174
  - military uses, 81-84
  - SPOT Image, S. A., 53
- Technology issues
  - developing advanced remote sensing systems, 135-141
  - EOS program restructuring, 110-124
  - Landsat follow-ons, 140-144
  - overview, 109-110
  - platforms, 124-135
- Television Infrared Observing Satellites, 14-15
- Temporal resolution, 60
- TES. See Tropospheric Emission Spectrometer
- TIROS. See Television Infrared Observing Satellites
- TOMS. See Total Ozone Mapping Spectrometer
- TOPEX/Poseidon
  - description, 58, 175
  - EOS Phase One, 105
- Total Ozone Mapping Spectrometer
  - EOS Phase One, 104-105
  - NASA, 177-178
  - polar-orbiting satellite, 41
  - research cooperation between NASA and NOAA, 36
- TRMM. See Tropical Rainfall Measurement Mission
- Tropical Rainfall Measurement Mission, 105
- Tropospheric Emission Spectrometer, 106
- UARS. See Upper Atmosphere Research Satellite
- UAVS. See Unpiloted air vehicles
- Unpiloted air vehicles
  - advantages, 125-128
  - description, 79-80, 125-126
  - Perseus, 127-128
  - specifications, 127
- Upper Atmosphere Research Satellite
  - cost performance, 23
  - global change research, 69,70
  - project goals, 105
- U.S. Global Change Research Program
  - Climsat, 76-77
  - complementing satellite measurements, 77-78
  - coordination of global change research, 28-29
  - current research efforts, 100
  - description, 63-64
  - existing satellite systems, 72-73
  - Mission to Planet Earth, 65-72
  - non-space-based research, 17
  - process studies, 79-80
  - program structure, 72
  - purpose, 13
  - small satellites, 73-76
  - unpiloted air vehicles, 79-80
- USGCRP. See U.S. Global Change Research Program
- Value-added services, 85-86
- Visible and Thermal Infrared Radiometer, 58
- VTIR. See Visible and Thermal Infrared Radiometer
- Weather monitoring
  - geostationary satellite system, 34-37
  - international cooperation, 90
  - meteorological satellite system, 42-44
  - non-U.S. environmental satellite systems, 44-45
  - observations of satellite sensors, 33-34
  - operational meteorological satellite systems, 14-15
  - polar-orbiting satellite system, 37-43
- Wedge Spectrometer, 144
- Wide Field Sensor, 53
- WiFS. See Wide Field Sensor
- Wind scatterometer, 57
- WMO. See World Meteorological Organization
- World Meteorological Organization, 35,41,90
- WorldView Imaging Corporation, 87